

SERIES 400 SWITCHES

ROCKER SWITCHES - SUB-MINIATURE

TACT SWITCHES

NAVIGATION SWITCHES

PUSHBUTTON SWITCHES

TOGGLE SWITCHES

ROCKER SWITCHES

SLIDE SWITCHES

SNAP-ACTION SWITCHES

DIP SWITCHES

KEYLOCK SWITCHES

ROTARY SWITCHES

DETECTOR SWITCHES

CAP OPTIONS



SPECIFICATIONS

Contact Rating:	See contact material options
Life Expectancy:	30,000 make-and-break cycles at full load
Contact Resistance:	20 mΩ max. typical initial @ 2-4 VDC 100 mA for silver and gold plated contacts
Insulation Resistance:	1,000 MΩ min
Dielectric Strength:	1,000 V RMS @ sea level
Operating Temperature:	-30° C to 85° C

MATERIALS

Case:	Diallyl phthalate (DAP) or glass filled nylon, flame retardant, heat stabilized (UL 94-V0)
Rocker:	Nylon
Bushing:	Brass, nickel plated
Housing:	Stainless steel
Terminal/Switch Support:	Brass, or steel tin plated
Contacts / Terminals:	Silver or gold plated copper alloy

FEATURES & BENEFITS

- ▶ Variety of switching functions
- ▶ Sub-miniature
- ▶ Multiple actuator options

APPLICATIONS/MARKETS

- ▶ Telecommunications
- ▶ Instrumentation
- ▶ Test equipment
- ▶ Networking
- ▶ Computer peripherals

HOW TO ORDER

SERIES	MODEL NO.	ACTUATOR	ACTUATOR COLOR	TERMINATION	CONTACT MATERIAL	SEAL
400	□ □ □ □ □	□ □	□ □ □	□ □ □ □	□	E
	MSP1 MSP2 MSP3 MSP4 MSP5 MSP6***	R1* R6**	BLK =Black WHT=White RED =Red	M1 M2 M6 M61 M7 M71 VS2 VS21	Q = Silver R = Gold	E = Epoxy Sealed at Base of Terminal

▶ ▶ ▶ Example Ordering Number
400-MSP1-R6-BLK-M6-R-E

* Std. all models except SPDT with M6 + M61 terminations.
** Std. on SPDT models with M6 + M61 terminations.
*** Not available with M6 terminations.

Specifications subject to change without notice.

SPDT

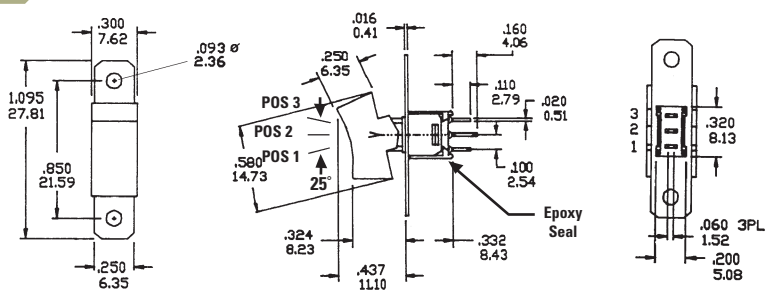

Model No.	POS 1	POS 2	POS 3
MSP-1	ON	NONE	ON
MSP-2	ON	NONE	(ON)
MSP-3	ON	OFF	ON
MSP-4	(ON)	OFF	(ON)
MSP-5	ON	OFF	(ON)
MSP-6	OFF	NONE	ON
Term. Comm.	2-3	OPEN	2-1

() = Momentary

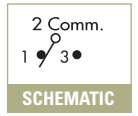



DPDT

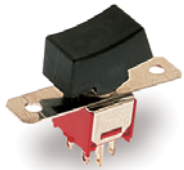

Model No.	POS 1	POS 2	POS 3
MDP-1	ON	NONE	ON
MDP-2	ON	NONE	(ON)
MDP-3	ON	OFF	ON
Term. Comm.	2-3, 5-6	OPEN	2-1, 5-4

() = Momentary

ACTUATOR OPTIONS

R1



Std. all models except SPDT with M6 terminations.

R6

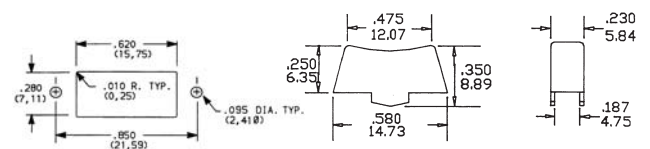

Std. on SPDT models with M6 terminations.

TERMINATION OPTIONS

M1

SOLDER LUG



Single Pole



Double Pole



M2

P.C. MOUNT



Single Pole

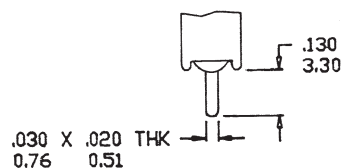

Double Pole

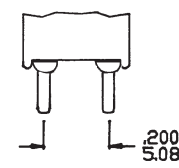



SERIES 400 SWITCHES

ROCKER SWITCHES - SUB-MINIATURE

TACT SWITCHES

NAVIGATION SWITCHES

PUSHBUTTON SWITCHES

TOGGLE SWITCHES

ROCKER SWITCHES

SLIDE SWITCHES

SNAP-ACTION SWITCHES

DIP SWITCHES

KEYLOCK SWITCHES

ROTARY SWITCHES

DETECTOR SWITCHES

CAP OPTIONS

M6

SPDT

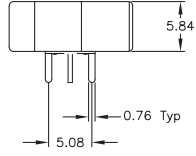

P.C. MOUNTING

M6

DPDT

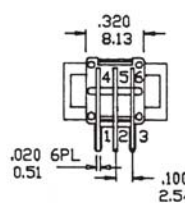
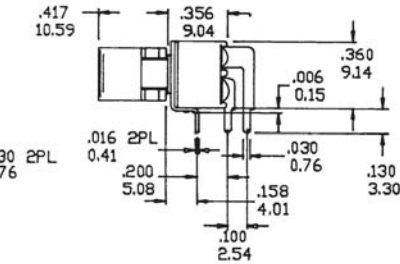
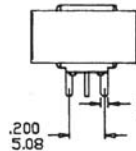

P.C. MOUNTING

M61

SPDT

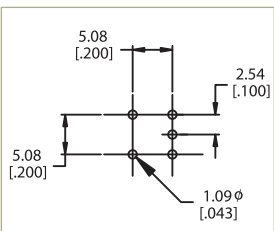
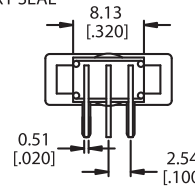
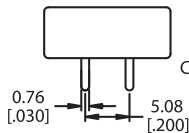

P.C. MOUNTING

M61

DPDT

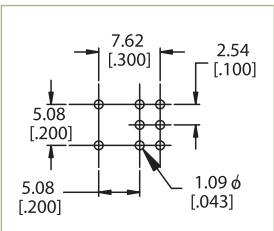
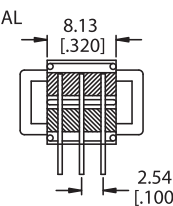
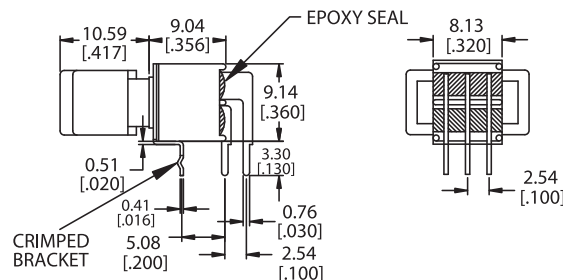
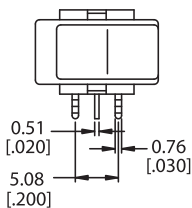

P.C. MOUNTING



M7

SPDT



M7

DPDT



M71

SPDT



TACT SWITCHES

NAVIGATION SWITCHES

PUSHBUTTON SWITCHES

TOGGLE SWITCHES

ROCKER SWITCHES

SLIDE SWITCHES

SNAP-ACTION SWITCHES

DIP SWITCHES

KEYLOCK SWITCHES

ROTARY SWITCHES

DETECTOR SWITCHES

CAP OPTIONS

SERIES 400 SWITCHES

ROCKER SWITCHES - SUB-MINIATURE

TACT SWITCHES

NAVIGATION SWITCHES

PUSHBUTTON SWITCHES

TOGGLE SWITCHES

ROCKER SWITCHES

SLIDE SWITCHES

SNAP-ACTION SWITCHES

DIP SWITCHES

KEYLOCK SWITCHES

ROTARY SWITCHES

DETECTOR SWITCHES

CAP OPTIONS

VS2

SPDT



VS2

DPDT

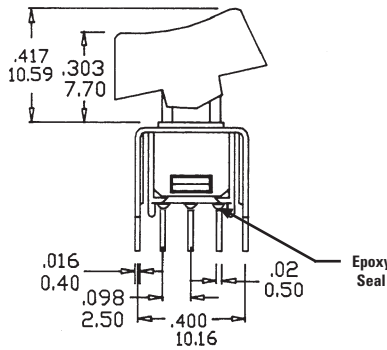
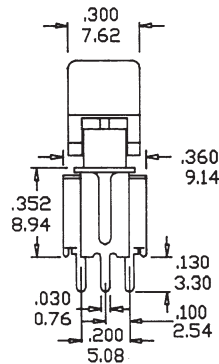

VS21

SPDT

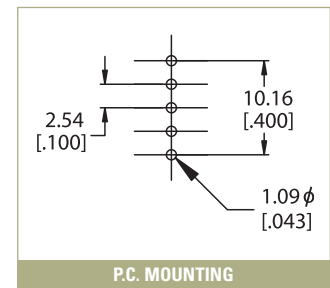

CONTACT MATERIAL OPTIONS

Q

Fixed Terminal:	Silver plated copper alloy
Moving Contact:	Silver plated copper alloy
Rating:	3 AMPS @ 120 VAC or 28 VDC; 1 AMP @ 250VAC

R

Fixed Terminal:	Copper alloy with gold plate over nickel plate
Moving Contact:	Copper alloy with gold plate over nickel plate
Rating:	0.4 VA max. @ 20 VAC or DC max.

Компания «Океан Электроники» предлагает заключение долгосрочных отношений при поставках импортных электронных компонентов на взаимовыгодных условиях!

Наши преимущества:

- Поставка оригинальных импортных электронных компонентов напрямую с производств Америки, Европы и Азии, а так же с крупнейших складов мира;
- Широкая линейка поставок активных и пассивных импортных электронных компонентов (более 30 млн. наименований);
- Поставка сложных, дефицитных, либо снятых с производства позиций;
- Оперативные сроки поставки под заказ (от 5 рабочих дней);
- Экспресс доставка в любую точку России;
- Помощь Конструкторского Отдела и консультации квалифицированных инженеров;
- Техническая поддержка проекта, помощь в подборе аналогов, поставка прототипов;
- Поставка электронных компонентов под контролем ВП;
- Система менеджмента качества сертифицирована по Международному стандарту ISO 9001;
- При необходимости вся продукция военного и аэрокосмического назначения проходит испытания и сертификацию в лаборатории (по согласованию с заказчиком);
- Поставка специализированных компонентов военного и аэрокосмического уровня качества (Xilinx, Altera, Analog Devices, Intersil, Interpoint, Microsemi, Actel, Aeroflex, Peregrine, VPT, Syfer, Eurofarad, Texas Instruments, MS Kennedy, Miteq, Cobham, E2V, MA-COM, Hittite, Mini-Circuits, General Dynamics и др.);

Компания «Океан Электроники» является официальным дистрибьютором и эксклюзивным представителем в России одного из крупнейших производителей разъемов военного и аэрокосмического назначения «JONHON», а так же официальным дистрибьютором и эксклюзивным представителем в России производителя высокотехнологичных и надежных решений для передачи СВЧ сигналов «FORSTAR».



JONHON

«JONHON» (основан в 1970 г.)

Разъемы специального, военного и аэрокосмического назначения:

(Применяются в военной, авиационной, аэрокосмической, морской, железнодорожной, горно- и нефтедобывающей отраслях промышленности)

«FORSTAR» (основан в 1998 г.)

ВЧ соединители, коаксиальные кабели,
кабельные сборки и микроволновые компоненты:

(Применяются в телекоммуникациях гражданского и специального назначения, в средствах связи, РЛС, а так же военной, авиационной и аэрокосмической отраслях промышленности).



Телефон: 8 (812) 309-75-97 (многоканальный)

Факс: 8 (812) 320-03-32

Электронная почта: ocean@oceanchips.ru

Web: <http://oceanchips.ru/>

Адрес: 198099, г. Санкт-Петербург, ул. Калинина, д. 2, корп. 4, лит. А