

# MJF122, MJF127

## Complementary Power Darlington

### For Isolated Package Applications

Designed for general-purpose amplifiers and switching applications, where the mounting surface of the device is required to be electrically isolated from the heatsink or chassis.

#### Features

- Electrically Similar to the Popular TIP122 and TIP127
- 100 V<sub>CEO(sus)</sub>
- 5.0 A Rated Collector Current
- No Isolating Washers Required
- Reduced System Cost
- High DC Current Gain – 2000 (Min) @ I<sub>C</sub> = 3 Adc
- UL Recognized, File #E69369, to 3500 V<sub>RMS</sub> Isolation
- Pb-Free Packages are Available\*

#### MAXIMUM RATINGS

Rating	Symbol	Value	Unit
Collector-Emitter Voltage	V <sub>CEO</sub>	100	Vdc
Collector-Base Voltage	V <sub>CB</sub>	100	Vdc
Emitter-Base Voltage	V <sub>EB</sub>	5	Vdc
RMS Isolation Voltage (Note 1) (t = 0.3 sec, R.H. ≤ 30%, T <sub>A</sub> = 25°C) Per Figure 14	V <sub>ISOL</sub>	4500	V <sub>RMS</sub>
Collector Current – Continuous Peak	I <sub>C</sub>	5 8	Adc
Base Current	I <sub>B</sub>	0.12	Adc
Total Power Dissipation (Note 2) @ T <sub>C</sub> = 25°C Derate above 25°C	P <sub>D</sub>	30 0.24	W W/°C
Total Power Dissipation @ T <sub>A</sub> = 25°C Derate above 25°C	P <sub>D</sub>	2 0.016	W W/°C
Operating and Storage Junction Temperature Range	T <sub>J</sub> , T <sub>stg</sub>	-65 to +150	I <sub>C</sub>

#### THERMAL CHARACTERISTICS

Characteristic	Symbol	Max	Unit
Thermal Resistance, Junction-to-Ambient	R <sub>θJA</sub>	62.5	°C/W
Thermal Resistance, Junction-to-Case (Note 2)	R <sub>θJC</sub>	4.1	°C/W
Lead Temperature for Soldering Purpose	T <sub>L</sub>	260	°C

Maximum ratings are those values beyond which device damage can occur. Maximum ratings applied to the device are individual stress limit values (not normal operating conditions) and are not valid simultaneously. If these limits are exceeded, device functional operation is not implied, damage may occur and reliability may be affected.

1. Proper strike and creepage distance must be provided.
2. Measurement made with thermocouple contacting the bottom insulated mounting surface (in a location beneath the die), the device mounted on a heatsink with thermal grease and a mounting torque of ≥ 6 in. lbs.



ON Semiconductor®

<http://onsemi.com>

### COMPLEMENTARY SILICON POWER DARLINGTONS 5.0 A, 100 V, 30 W

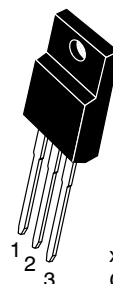
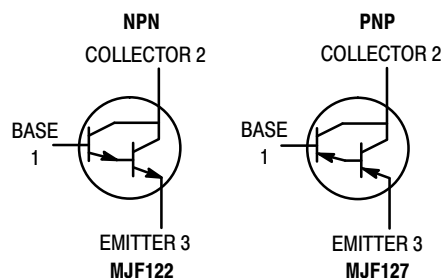

#### MARKING DIAGRAM

TO-220  
CASE 221D-02  
STYLE 2



x = 2 or 7  
G = Pb-Free Package  
A = Assembly Location  
Y = Year  
WW = Work Week

#### ORDERING INFORMATION

Device	Package	Shipping†
MJF122	TO-220	50 Units / Rail
MJF122G	TO-220 (Pb-Free)	50 Units / Rail
MJF127	TO-220	50 Units / Rail
MJF127G	TO-220 (Pb-Free)	50 Units / Rail

†For information on tape and reel specifications, including part orientation and tape sizes, please refer to our Tape and Reel Packaging Specifications Brochure, BRD8011/D.

\*For additional information on our Pb-Free strategy and soldering details, please download the ON Semiconductor Soldering and Mounting Techniques Reference Manual, SOLDERRM/D.

# MJF122, MJF127

## ELECTRICAL CHARACTERISTICS (T<sub>C</sub> = 25°C unless otherwise noted)

Characteristic	Symbol	Min	Max	Unit
<b>OFF CHARACTERISTICS</b>				
Collector–Emitter Sustaining Voltage (Note 3) (I <sub>C</sub> = 100 mAdc, I <sub>B</sub> = 0)	V <sub>CEO(sus)</sub>	100	–	Vdc
Collector Cutoff Current (V <sub>CE</sub> = 50 Vdc, I <sub>B</sub> = 0)	I <sub>CEO</sub>	–	10	μAdc
Collector Cutoff Current (V <sub>CB</sub> = 100 Vdc, I <sub>E</sub> = 0)	I <sub>CBO</sub>	–	10	μAdc
Emitter Cutoff Current (V <sub>BE</sub> = 5 Vdc, I <sub>C</sub> = 0)	I <sub>EBO</sub>	–	2	mAdc
<b>ON CHARACTERISTICS</b> (Note 3)				
DC Current Gain (I <sub>C</sub> = 0.5 Adc, V <sub>CE</sub> = 3 Vdc) (I <sub>C</sub> = 3 Adc, V <sub>CE</sub> = 3 Vdc)	h <sub>FE</sub>	1000 2000	– –	–
Collector–Emitter Saturation Voltage (I <sub>C</sub> = 3 Adc, I <sub>B</sub> = 12 mAdc) (I <sub>C</sub> = 5 Adc, I <sub>B</sub> = 20 mAdc)	V <sub>CE(sat)</sub>	– –	2 3.5	Vdc
Base–Emitter On Voltage (I <sub>C</sub> = 3 Adc, V <sub>CE</sub> = 3 Vdc)	V <sub>BE(on)</sub>	–	2.5	Vdc
<b>DYNAMIC CHARACTERISTICS</b>				
Small–Signal Current Gain (I <sub>C</sub> = 3 Adc, V <sub>CE</sub> = 4 Vdc, f = 1 MHz)	h <sub>fe</sub>	4	–	–
Output Capacitance (V <sub>CB</sub> = 10 Vdc, I <sub>E</sub> = 0, f = 0.1 MHz)	MJF127 MJF122 C <sub>ob</sub>	– –	300 200	pF

3. Pulse Test: Pulse Width ≤ 300 μs, Duty Cycle ≤ 2%.

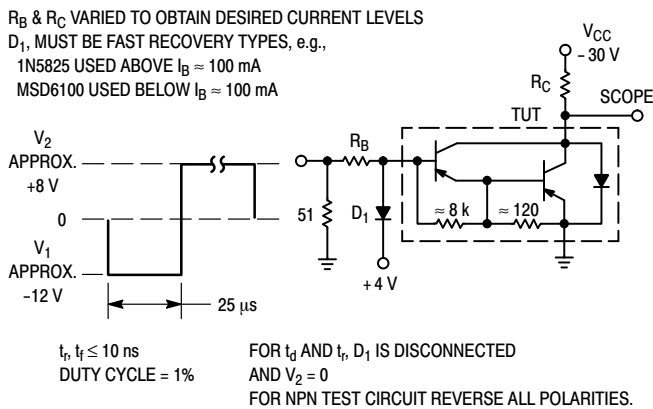

Figure 1. Switching Times Test Circuit

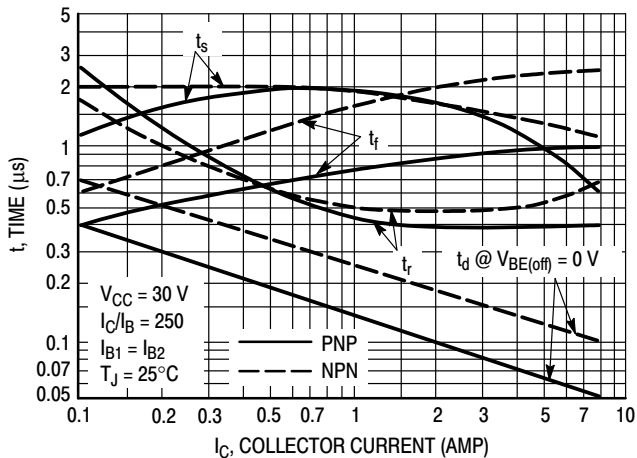

Figure 2. Typical Switching Times

# MJF122, MJF127

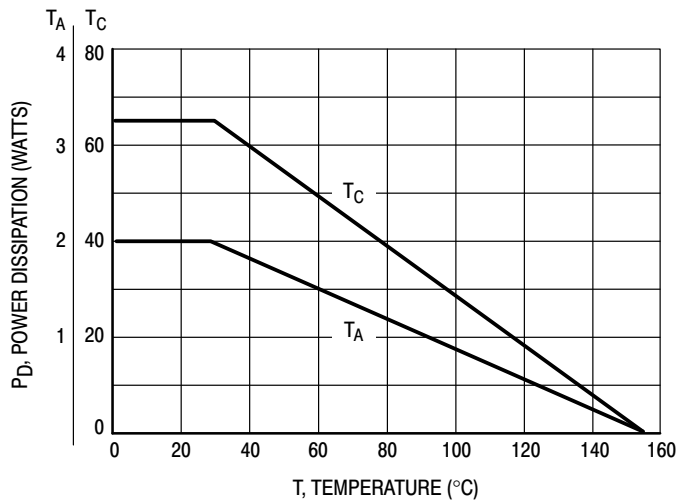

Figure 3. Maximum Power Derating

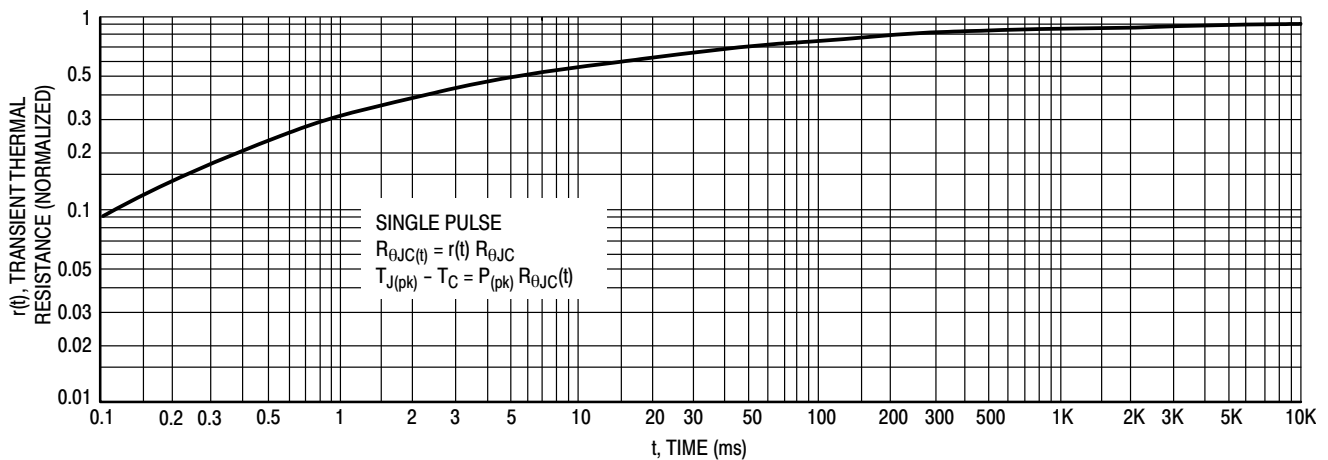

Figure 4. Thermal Response

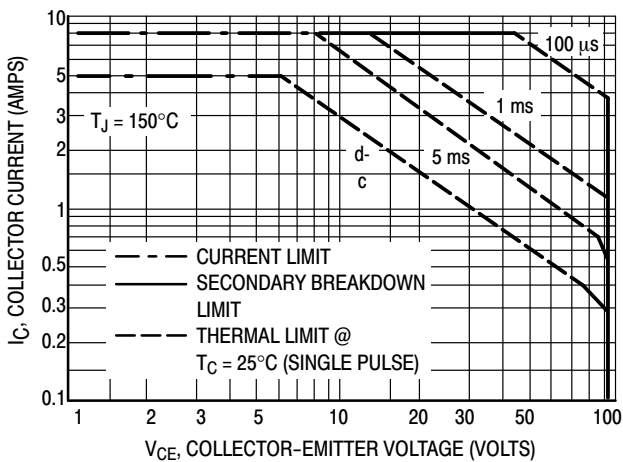

Figure 5. Maximum Forward Bias Safe Operating Area

There are two limitations on the power handling ability of a transistor: average junction temperature and second breakdown. Safe operating area curves indicate  $I_C - V_{CE}$  limits of the transistor that must be observed for reliable operation; i.e., the transistor must not be subjected to greater dissipation than the curves indicate.

The data of Figure 5 is based on  $T_{J(pk)} = 150^\circ\text{C}$ ;  $T_C$  is variable depending on conditions. Secondary breakdown pulse limits are valid for duty cycles to 10% provided  $T_{J(pk)} < 150^\circ\text{C}$ .  $T_{J(pk)}$  may be calculated from the data in Figure 4. At high case temperatures, thermal limitations will reduce the power that can be handled to values less than the limitations imposed by secondary breakdown.

# MJF122, MJF127

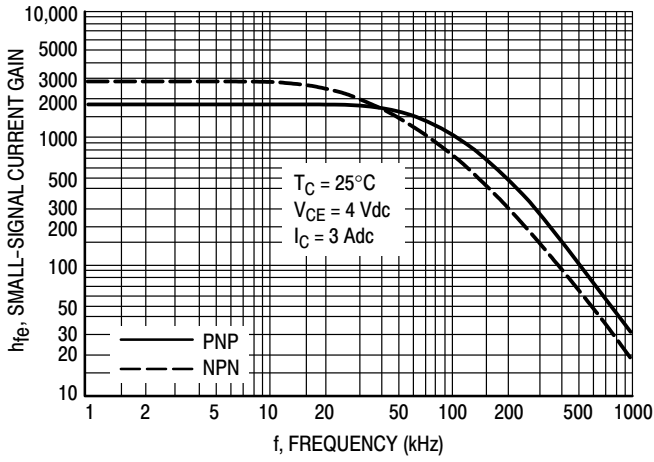

Figure 6. Typical Small-Signal Current Gain

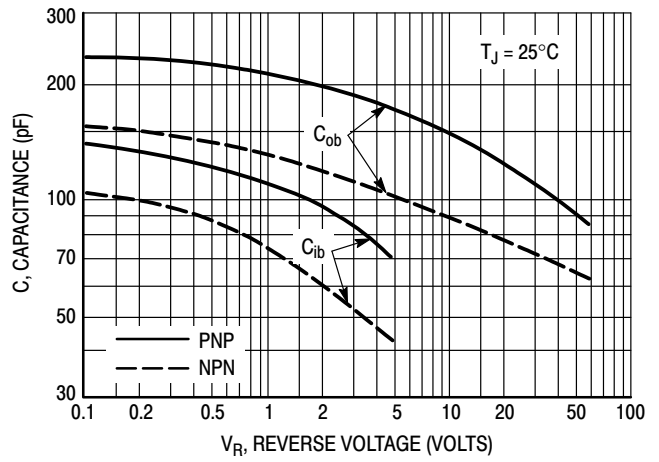

Figure 7. Typical Capacitance

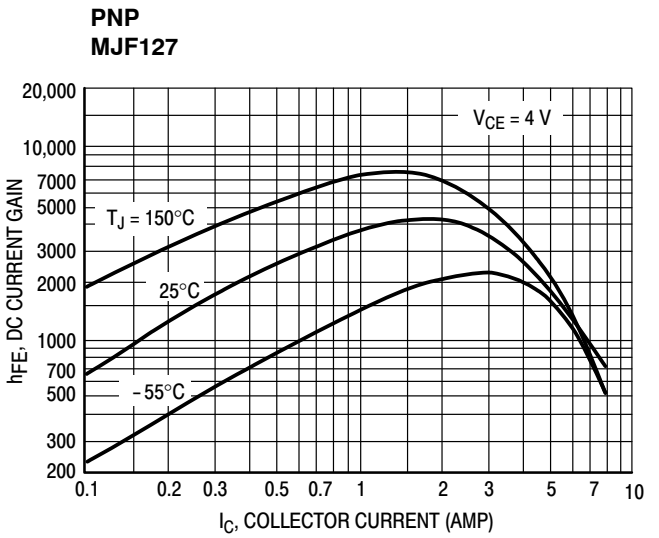
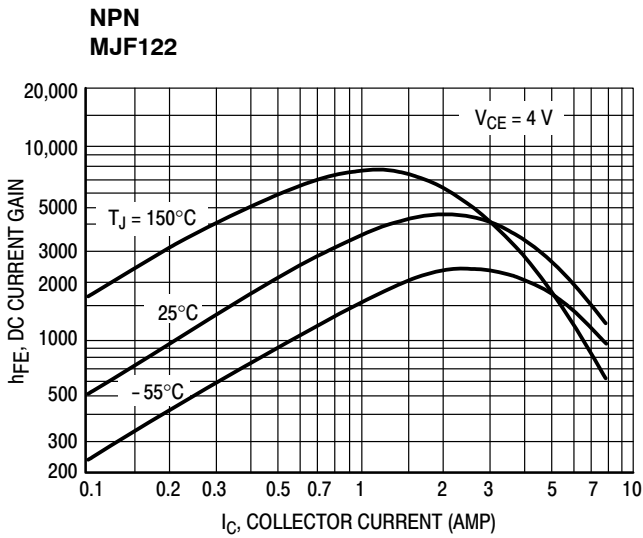

Figure 8. Typical DC Current Gain

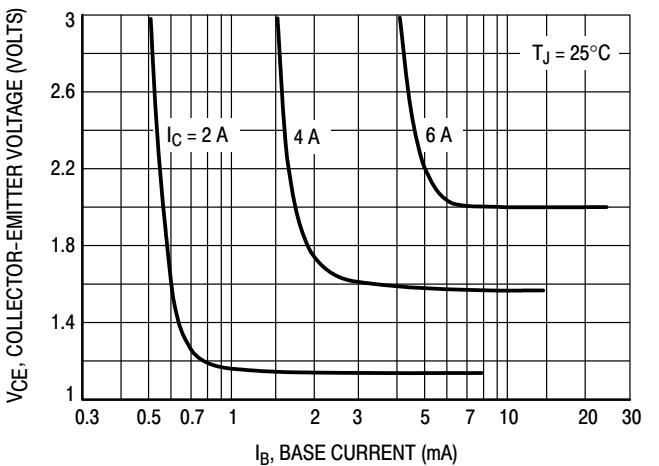
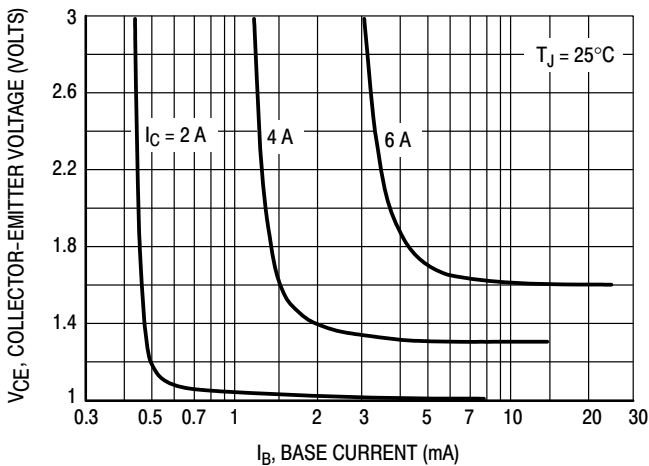
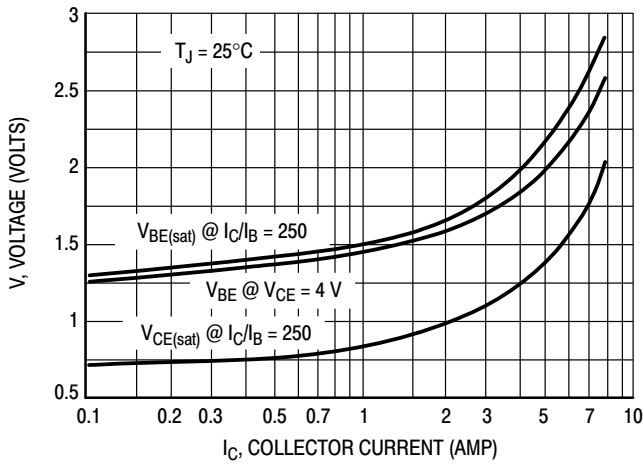

Figure 9. Typical Collector Saturation Region

# MJF122, MJF127

**NPN  
MJF122**



**PNP  
MJF127**

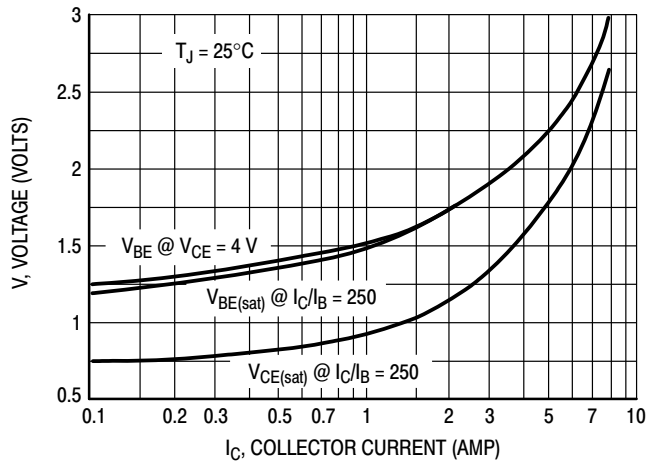

**Figure 10. Typical "On" Voltages**

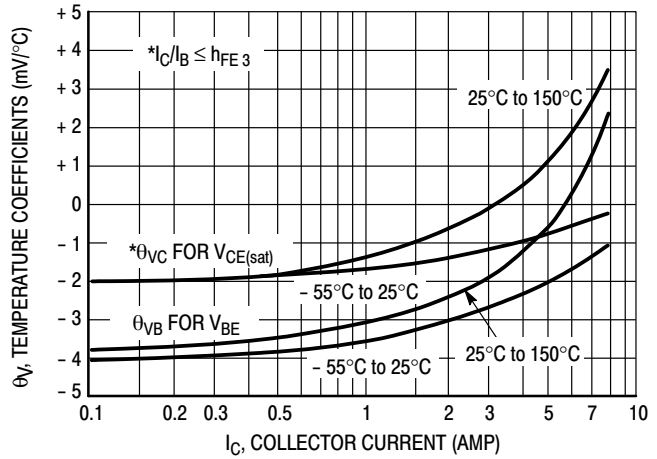
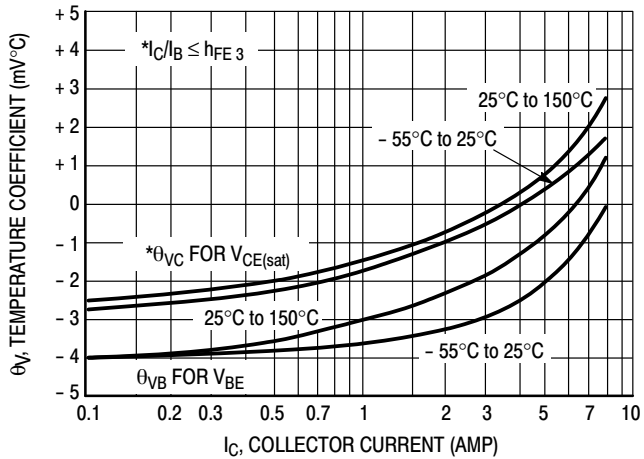

**Figure 11. Typical Temperature Coefficients**

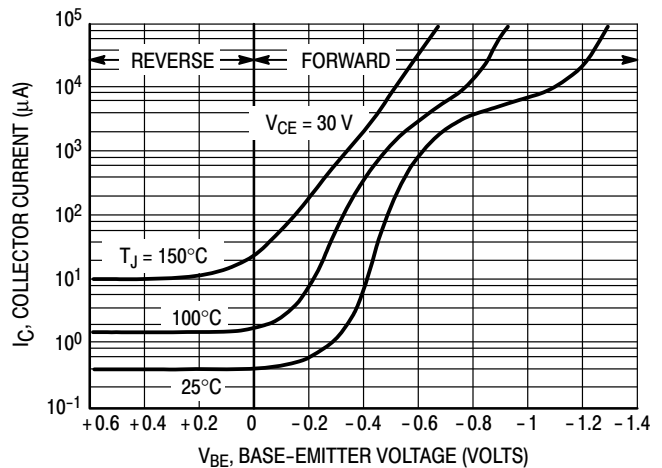
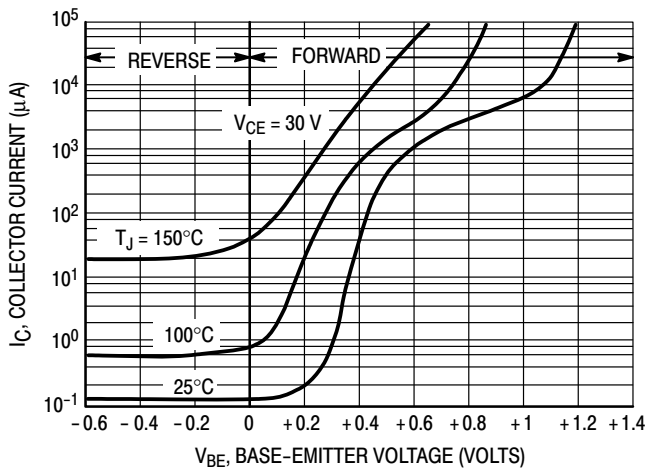

**Figure 12. Typical Collector Cut-Off Region**

# MJF122, MJF127

**NPN  
MJF122**

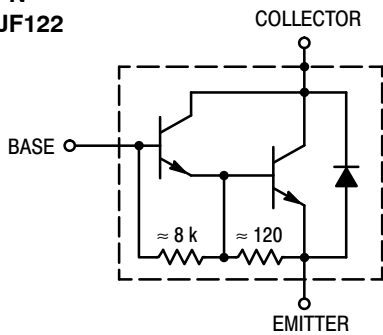

**PNP  
MJF127**

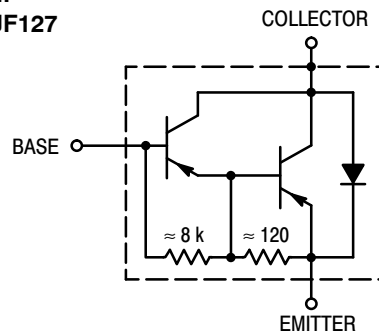

**Figure 13. Darlington Schematic**

## TEST CONDITIONS FOR ISOLATION TESTS\*

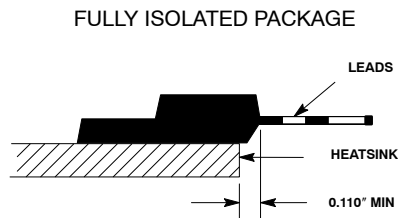

**Figure 14. Mounting Position**

\*Measurement made between leads and heatsink with all leads shorted together.

## MOUNTING INFORMATION

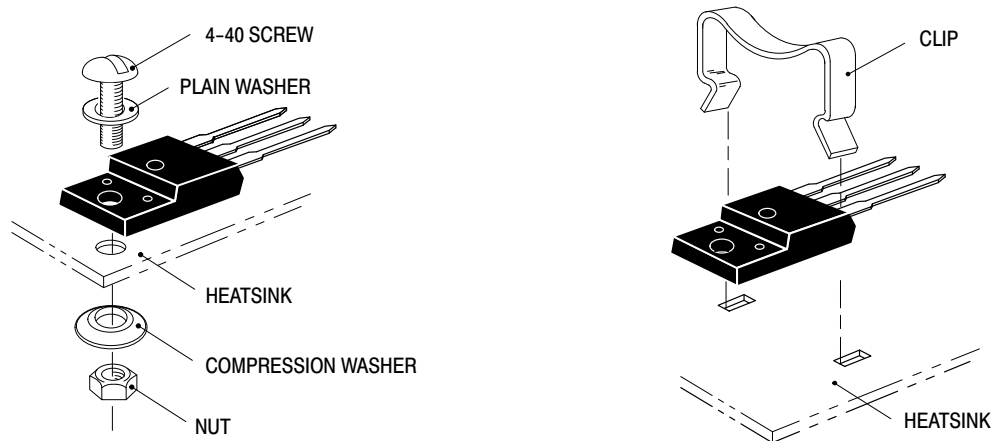

**Figure 15. Typical Mounting Techniques\***

Laboratory tests on a limited number of samples indicate, when using the screw and compression washer mounting technique, a screw torque of 6 to 8 in · lbs is sufficient to provide maximum power dissipation capability. The compression washer helps to maintain a constant pressure on the package over time and during large temperature excursions.

Destructive laboratory tests show that using a hex head 4-40 screw, without washers, and applying a torque in excess of 20 in · lbs will cause the plastic to crack around the mounting hole, resulting in a loss of isolation capability.

Additional tests on slotted 4-40 screws indicate that the screw slot fails between 15 to 20 in · lbs without adversely affecting the package. However, in order to positively ensure the package integrity of the fully isolated device, ON Semiconductor does not recommend exceeding 10 in · lbs of mounting torque under any mounting conditions.

\*\* For more information about mounting power semiconductors see Application Note AN1040.

# MJF122, MJF127

## PACKAGE DIMENSIONS

TO-220  
CASE 221D-03  
ISSUE J

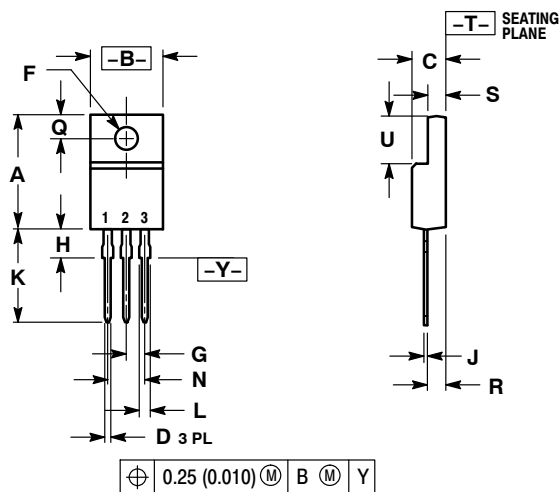

- NOTES:
1. DIMENSIONING AND TOLERANCING PER ANSI Y14.5M, 1982.
  2. CONTROLLING DIMENSION: INCH
  3. 221D-01 THRU 221D-02 OBSOLETE, NEW STANDARD 221D-03.

DIM	INCHES		MILLIMETERS	
	MIN	MAX	MIN	MAX
A	0.617	0.635	15.67	16.12
B	0.392	0.419	9.96	10.63
C	0.177	0.193	4.50	4.90
D	0.024	0.039	0.60	1.00
F	0.116	0.129	2.95	3.28
G	0.100 BSC		2.54 BSC	
H	0.118	0.135	3.00	3.43
J	0.018	0.025	0.45	0.63
K	0.503	0.541	12.78	13.73
L	0.048	0.058	1.23	1.47
N	0.200 BSC		5.08 BSC	
Q	0.122	0.138	3.10	3.50
R	0.099	0.117	2.51	2.96
S	0.092	0.113	2.34	2.87
U	0.239	0.271	6.06	6.88

- STYLE 2:
1. BASE
  2. COLLECTOR
  3. EMITTER

ON Semiconductor and are registered trademarks of Semiconductor Components Industries, LLC (SCILLC). SCILLC reserves the right to make changes without further notice to any products herein. SCILLC makes no warranty, representation or guarantee regarding the suitability of its products for any particular purpose, nor does SCILLC assume any liability arising out of the application or use of any product or circuit, and specifically disclaims any and all liability, including without limitation special, consequential or incidental damages. "Typical" parameters which may be provided in SCILLC data sheets and/or specifications can and do vary in different applications and actual performance may vary over time. All operating parameters, including "Typicals" must be validated for each customer application by customer's technical experts. SCILLC does not convey any license under its patent rights nor the rights of others. SCILLC products are not designed, intended, or authorized for use as components in systems intended for surgical implant into the body, or other applications intended to support or sustain life, or for any other application in which the failure of the SCILLC product could create a situation where personal injury or death may occur. Should Buyer purchase or use SCILLC products for any such unintended or unauthorized application, Buyer shall indemnify and hold SCILLC and its officers, employees, subsidiaries, affiliates, and distributors harmless against all claims, costs, damages, and expenses, and reasonable attorney fees arising out of, directly or indirectly, any claim of personal injury or death associated with such unintended or unauthorized use, even if such claim alleges that SCILLC was negligent regarding the design or manufacture of the part. SCILLC is an Equal Opportunity/Affirmative Action Employer. This literature is subject to all applicable copyright laws and is not for resale in any manner.

### PUBLICATION ORDERING INFORMATION

**LITERATURE FULFILLMENT:**  
Literature Distribution Center for ON Semiconductor  
P.O. Box 5163, Denver, Colorado 80217 USA  
**Phone:** 303-675-2175 or 800-344-3860 Toll Free USA/Canada  
**Fax:** 303-675-2176 or 800-344-3867 Toll Free USA/Canada  
**Email:** orderlit@onsemi.com

**N. American Technical Support:** 800-282-9855 Toll Free  
USA/Canada  
**Europe, Middle East and Africa Technical Support:**  
Phone: 421 33 790 2910  
**Japan Customer Focus Center**  
Phone: 81-3-5773-3850

**ON Semiconductor Website:** [www.onsemi.com](http://www.onsemi.com)  
**Order Literature:** <http://www.onsemi.com/orderlit>

For additional information, please contact your local Sales Representative

Компания «Океан Электроники» предлагает заключение долгосрочных отношений при поставках импортных электронных компонентов на взаимовыгодных условиях!

Наши преимущества:

- Поставка оригинальных импортных электронных компонентов напрямую с производств Америки, Европы и Азии, а так же с крупнейших складов мира;
- Широкая линейка поставок активных и пассивных импортных электронных компонентов (более 30 млн. наименований);
- Поставка сложных, дефицитных, либо снятых с производства позиций;
- Оперативные сроки поставки под заказ (от 5 рабочих дней);
- Экспресс доставка в любую точку России;
- Помощь Конструкторского Отдела и консультации квалифицированных инженеров;
- Техническая поддержка проекта, помощь в подборе аналогов, поставка прототипов;
- Поставка электронных компонентов под контролем ВП;
- Система менеджмента качества сертифицирована по Международному стандарту ISO 9001;
- При необходимости вся продукция военного и аэрокосмического назначения проходит испытания и сертификацию в лаборатории (по согласованию с заказчиком);
- Поставка специализированных компонентов военного и аэрокосмического уровня качества (Xilinx, Altera, Analog Devices, Intersil, Interpoint, Microsemi, Actel, Aeroflex, Peregrine, VPT, Syfer, Eurofarad, Texas Instruments, MS Kennedy, Miteq, Cobham, E2V, MA-COM, Hittite, Mini-Circuits, General Dynamics и др.);

Компания «Океан Электроники» является официальным дистрибьютором и эксклюзивным представителем в России одного из крупнейших производителей разъемов военного и аэрокосмического назначения «JONHON», а так же официальным дистрибьютором и эксклюзивным представителем в России производителя высокотехнологичных и надежных решений для передачи СВЧ сигналов «FORSTAR».



## JONHON

«JONHON» (основан в 1970 г.)

Разъемы специального, военного и аэрокосмического назначения:

(Применяются в военной, авиационной, аэрокосмической, морской, железнодорожной, горно- и нефтедобывающей отраслях промышленности)

«FORSTAR» (основан в 1998 г.)

ВЧ соединители, коаксиальные кабели, кабельные сборки и микроволновые компоненты:

(Применяются в телекоммуникациях гражданского и специального назначения, в средствах связи, РЛС, а так же военной, авиационной и аэрокосмической отраслях промышленности).



Телефон: 8 (812) 309-75-97 (многоканальный)

Факс: 8 (812) 320-03-32

Электронная почта: [ocean@oceanchips.ru](mailto:ocean@oceanchips.ru)

Web: <http://oceanchips.ru/>

Адрес: 198099, г. Санкт-Петербург, ул. Калинина, д. 2, корп. 4, лит. А