

Harmony™ 9001K/SK/KX 30 mm push buttons

Catalog
2011



Harmony™ 9001K/SK/KX 30 mm push buttons

| | |
|---|----|
| Introduction | 4 |
| <i>9001K heavy-duty operators with chrome-plated bezels:</i> | |
| Product range | 5 |
| Specifications | 7 |
| References | |
| □ Push buttons and mushroom operators | 10 |
| □ Multi-function operators | 12 |
| □ Selector switches | 13 |
| □ Pilot lights | 17 |
| □ Specialty operators | 18 |
| □ Contact blocks | 20 |
| □ Light modules | 24 |
| □ Legend plates | 25 |
| □ Accessories | 27 |
| □ Replacement parts | 29 |
| Dimensions | 30 |
| <i>9001SK corrosion-resistant operators with black plastic bezels:</i> | |
| Product range | 36 |
| Specifications | 38 |
| References | |
| □ Push buttons and mushroom operators | 41 |
| □ Multi-function operators | 43 |
| □ Selector switches | 44 |
| □ Pilot lights | 48 |
| □ Specialty operators | 49 |
| □ Contact blocks | 50 |
| □ Light modules | 54 |
| □ Legend plates | 55 |
| □ Accessories | 57 |
| □ Replacement parts | 59 |
| Dimensions | 60 |
| <i>9001KX multi-function operators with chrome-plated square-head bezels:</i> | |
| Product range | 66 |
| Specifications | 67 |
| References | |
| □ Push buttons with contacts | 70 |
| □ Push buttons without contacts | 71 |
| □ Selector switches | 72 |
| □ Contact blocks | 72 |
| □ Pilot lights | 73 |
| □ Legend plates | 74 |
| □ Accessories | 75 |
| Dimensions | 76 |
| Index | 78 |

Harmony™ 9001K/SK/KX 30 mm push buttons



Introduction

Schneider Electric's Harmony™ 9001 30 mm push buttons, pilot lights, selector switches and mushroom head operators provide robust and reliable solutions for a wide range of heavy industry applications.

- **9001K** operators are rugged and include chrome-plated bezels. (See page 5.)
- **9001SK** operators include black plastic bezels for corrosion-resistant applications. (See page 36.)
- **9001KX** operators include chrome-plated square bezels and provide multi-function operation. (See page 66.)

Product features:

- Heavy duty, oil-tight, dust-tight, and water-tight without boots. Most units are IP66 rated and are UL types 4, 4X and 13.
- FINGERSAFE™ contact blocks and light modules for improved safety
- Interchangeable light modules, contact blocks, color caps, pilot light lenses and mushroom heads reduce inventory
- Integrated earth ground connection (no ground wires required)
- Easy installation with octagonal ring nut
- Metal or plastic legend plates

Contact block features:

- Clear window for status of contact operation and troubleshooting
- Color coded for easy identification
- Single screw mounting for quick installation
- Side-by-side and/or stacked mounting to minimize enclosure space requirements

Light module features:

- Low-cost incandescent lamps or energy-efficient, long-life LED lamps
- Wide range of voltages from 24V to 600V

All products are:

- UL listed and CSA certified
- CE declaration of conformity
- RoHS compliant

Complete units

Contact functions

Push buttons, spring return



Full guard

9001KR1●●● See page 10



No guard

9001KR3●●● See page 10



Extended guard

9001KR2●●● See page 10

Mushroom head push buttons



Spring return 1-3/8 or 2-1/4 in (35 or 57 mm)

9001KR2●●H13 See page 10

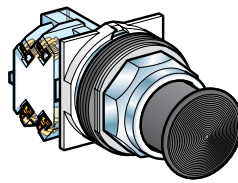

Push-pull 1-5/8 in (41 mm)

9001KR●●● See page 10



Turn-to-release, trigger action

9001KR16 (1) See page 12

Selector switches, key switches and joystick controllers

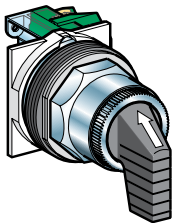

Selector switches

9001KS●●FBH●● See pages 13 to 15



Key switches

9001KS●●K●H●● See pages 13 to 15



Joystick controllers

9001K●●H● See page 18

Light functions

Pilot lights

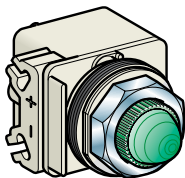

BA 9s base mounted super bright LED

9001KP●●● See page 17

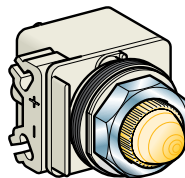

BA 9s incandescent bulb

9001KP●●● See page 17

(1) Complies with EN418/ISO13850 standards for Emergency Stop push buttons when used with circular Legend Plate 9001KN8330 (90 mm diameter) or 9001KN9330 (60 mm diameter). See page 26.

Harmony™ 9001K/SK/KX 30 mm push buttons

9001K – Complete units, components and accessories

Complete units

Combined contact and light functions

Illuminated push buttons, spring return



Full guard, super bright LED

9001K●L●●● See page 11



No guard

9001K2L●●● See page 11



Push-to-test, no guard, super bright LED

9001KT●●●31 See page 11

1-5/8 in (41 mm) mushroom head illuminated push buttons, super bright LED



2-Position, push-pull

9001KR9P●●● See page 12



3-Position, push-pull

9001KR8P●●● See page 12

Separate components and accessories



Complete units are composed of:

- 1 - Contact block
- 2 - Light module with lamp
- 3 - Black compensation gaskets
- 4 - Legend plate
- 5 - Locking thrust washer (for electrical grounding)
- 6 - Ring nut
- 7 - Color cap
- 8 - Color insert

Specifications:
page 7

References:
page 10

Dimensions:
page 30

Mounting:
page 31

Harmony™ 9001K/SK/KX

30 mm push buttons

9001K

| Environmental specifications | | | |
|---|---|---------|--|
| Conforming to standards |  Marked  | | EN/IEC 60947-1, EN/IEC 60947-5-1, EN/IEC 60947-5-4, JIS C 4520 and 852, UL 508, CSA C22-2 n° 14, CE marked, RoHS compliant |
| Product certifications |  File E78403 CCN NKCR  File LR25490 Class 3211-03 | | UL File E78403, CCN NKCR and CSA File LR25490, Class 3211-03 |
| Protective treatment standard version | | | "TC" |
| Ambient air temperature around the device | Storage | °F (°C) | -40 to +158 (-40 to +70) |
| | Operation | °F (°C) | -13 to +158 (-25 to +70) |
| Vibration resistance | Conforming to IEC 60068-2-6 | | Frequency: 2 to 500 Hz: 7gn Ford Standard EA-1 |
| Shock resistance | Conforming to IEC 60068-2-27 | | Half sine wave: 50 gn |
| Electric shock protection | Conforming to IEC 61140 | | Class II |
| Degree of protection | Conforming to EN/IEC 60529 | | IP 66 |
| | Conforming to NEMA | | Types 1, 2, 3, 3R, 4, 12 and 13 |
| Mechanical life (in millions of operating cycles) | Push buttons, spring return | | 5 |
| | Illuminated push buttons | | 5 |
| | Selector switches and key switches | | 0.5 |
| Mounting position | | | All positions |

| Electrical characteristics of contact blocks | | | | |
|---|---|--|---|--|
| Rated operational characteristics | ~ AC-15 | | 3 A, 240 V | |
| | --- DC-13 | | 0.55 A, 125 V | |
| Rated insulation voltage | Conforming to EN/IEC 60947-1 | V | U _i = 250 degree of pollution 3 (except pilot lights with incandescent bulb: degree of pollution 2) | |
| Rated impulse withstand voltage | Conforming to EN/IEC 60947-1 | kV | U _{imp} = 2.5 | |
| Contact material | Normal environment and usage | | Silver alloy | |
| Contact operation | "N/C" ou "N/O" | | Slow break | |
| Positive operation | Conforming to EN/IEC 60947-5-1 | N | N/C contact(s) with positive opening operation | |
| Short-circuit protection | Conforming to EN/IEC 60947-5-1 | A | Cartridge fuse mounted upstream: 10 | |
| Cabling capacity (9001KA contact blocks and 9001KM light modules) | Conforming to EN/IEC 60947-1 | mm ² mm ² | Screw clamp terminals (cross headed/slotted screw) Mini: 1 x 0.22 Maxi: 2 x 1.5 Recommended tightening torque: 0.8 N.m (10 in-lbs) | |
| Thermal current | I _{th} | A | 10 | |
| Maximum operation current | a.c. supply: utilization category AC-15 NEMA A600 | Contact making capacity | | |
| | | V | 120 240 480 600 | |
| | | A VA | 60 30 15 12 7200 7200 7200 7200 | |
| | | | Breaking capacity | |
| | V | 120 240 480 600 | | |
| | A VA | 6 3 1.5 1.2 720 720 720 720 | | |
| d.c. supply: utilization category DC-13 NEMA Q600 | Contact making capacity and breaking capacity | | | |
| | V A | 125 250 600 0.1 0.55 0.27 | | |

Harmony™ 9001K/SK/KX

30 mm push buttons

9001K

Basic Operators

(For Color Caps, Mushroom Buttons, Knobs, Selector Switch Cams, Contact Blocks, Light Modules and Legend Plates, see page 21.)

| Description | UL Types/NEMA Types 4, 13 |
|---|--|
| Non Illuminated Push Button (Full Guard) | 9001KR1 |
| Non Illuminated Push Button (Extended Guard) | 9001KR2 |
| Non Illuminated Push Button (No Guard) | 9001KR3 |
| Non Illuminated Push Button (Mushroom Button/screw on) | 9001KR20 |
| Non Illuminated Dual Push Button (Momentary) | 9001KR6 |
| Non Illuminated Dual Push Button (Momentary Interlocked) | 9001KR67 |
| Non Illuminated Dual Push Button (Maintained Interlocked) | 9001KR7 |
| Momentary Pull - Maintained Neutral - Momentary Push | 9001KR8 (1) (4) |
| Maintained Pull - Maintained Push | 9001KR9 (1) (4) |
| Illuminated Push Button (Full Guard - Plastic Top) | 9001K1L (2) |
| Illuminated Push Button and Push-to-test (No Guard) | 9001K2L (2) (3) |
| Illuminated Push Button (Full Guard - Metal Top) | 9001K3L (2) |
| Standard Pilot Light | 9001KP |
| 2-Position Selector Switch | 9001KS1 (1), 9001KS2 (1), 9001KS3 (1) |
| 3-Position Selector Switch | 9001KS4 (1), 9001KS5 (1), 9001KS6 (1), 9001KS7 (1) |
| 4-Position Selector Switch | 9001KS8 (1) |
| Trigger-Action Emergency Stop | 9001KR16 (1) |

(1) Operator can be converted to an illuminated operator by removing the liner (6509704901) and adding a light module.

(2) Operator can be converted to a non-illuminated operator by adding liner (6509704901).

(3) Operator includes jumper wires for push-to-test conversion.

(4) These operators can be supplied with 1-3/8" or 2-1/4" dia. mushroom buttons. For 1-3/8" Add *20 to reference number. The * refers to the color chosen - see page 10. For 2-1/4": Add *21 to reference number. The * refers to the color chosen - see page 10. Voids UL and NEMA Type 6 Rating.

Non Hazardous Locations:



Hazardous Locations (Reed contact blocks, see page 23):



Harmony™ 9001K/SK/KX

30 mm push buttons

9001K

9001K Operator Materials:

Push Button and Push-to-test Pilot Light
(9001KR and 9001KT)

- Gasket – Nitrile
- Seal – Nitrile
- Seal Cap – Amorphous Acetal
- Decorative Ring – Polyester Film
- Compensating Washer – Polypropylene
- Lock Ring – Amorphous Nylon
- Stem – Thermoplastic Polyester
- Base Cap – Thermoplastic Polyester
- Knob – Polycarbonate
- Liner – Polypropylene
- Hold Down Spring for 9001K-15 – Neoprene
- Operator Base – Zinc
- Operator Base (9001KR8) – Polyester
- Return Spring – Music Wire or Stainless Steel (9001KT only)
- Ring Nuts – Aluminum or Zinc
- Springkeeper – Steel
- Locking Thrust Washer – Zinc
- Color Insert – Polyethylene
- Boots – Silicone

Selector Switch (9001KS)

- Gasket – Nitrile
- Seal – Nitrile
- Bearing Washer – Polyester Film
- Compensating Washer – Polypropylene
- Cam Follower – Delrin 100
- Liner – Polypropylene
- Knob – Polycarbonate
- Cam Carrier – Amorphous Nylon
- Cam Rotor – Celenex 3300
- Cam Profile – Delrin 100
- Operator Base – Zinc
- Detent Spring – Stainless Steel
- Ring Nuts – Aluminum or Zinc
- Seal keeper – Stainless Steel
- Locking Thrust Washer – Zinc

Pilot Light (9001KP)

- Gasket – Nitrile
- Compensating Washer – Polypropylene
- Lens – Glass or Polycarbonate
- Light Module Housing – Thermoplastic Polyester
- Operator Base – Zinc
- Glass Lens Ring – Anodized Aluminum

Contact Block And Light Module Materials:

Contact Block (9001KA)

- Housing – Amorphous Nylon
- Contact Slider – Phenolic, Nylon or Acetal
- Terminal – Steel
- Saddle Clamp – Steel
- Spring – Stainless Steel
- Contacts – Silver and Copper
- Blade – Beryllium Copper
- Mounting Screw – Steel
- Label – Paper

Light Module (9001KM)

- Housing – Thermoplastic Polyester
- Socket – Steel
- Terminal – Steel with Tin Plate
- Saddle Clamp – Steel
- Translating Pin – Polycarbonate
- Transformer – Thermoplastic Polyester, Steel, Copper, Polyvinyl Chloride, Polytetrafluorethylene, Acetate, Paper
- Lamp Spring – Tin Plated Music Wire

Harmony™ 9001K/SK/KX 30 mm push buttons

9001K – Push buttons and mushroom operators

Note: When ordering, add prefix “9001” to the reference.

Non-Illuminated Momentary Push Button Operators
For use in hazardous locations, see page 23.
Contact blocks and legend plate not included unless otherwise noted.

| Description | Color | Operator with 1 N.O. and 1 N.C. Contact (KA1) | Operator with 1 N.O. Contact (KA2) | Operator with 1 N.C. Contact (KA3) | Operator Only with No Contacts | |
|--|--|--|------------------------------------|------------------------------------|--------------------------------|--------|
|  9001KR1B Full Guard | Black | KR1BH13 | KR1BH5 | KR1BH6 | KR1B | |
| | Red | KR1RH13 | KR1RH5 | KR1RH6 | KR1R | |
| | Green | KR1GH13 | KR1GH5 | KR1GH6 | KR1G | |
| | Universal (1) | KR1UH13 | KR1UH5 | KR1UH6 | KR1U | |
| | Other (2) | KR1■H13 | KR1■H5 | KR1■H6 | KR1■ | |
|  9001KR3B No Guard | Black | KR3BH13 | KR3BH5 | KR3BH6 | KR3B | |
| | Red | KR3RH13 | KR3RH5 | KR3RH6 | KR3R | |
| | Green | KR3GH13 | KR3GH5 | KR3GH6 | KR3G | |
| | Universal (1) | KR3UH13 | KR3UH5 | KR3UH6 | KR3U | |
| | Other (2) | KR3■H13 | KR3■H5 | KR3■H6 | KR3■ | |
|  9001KR2B Extended Guard | Black | KR2BH13 | KR2BH5 | KR2BH6 | KR2B | |
| | Red | KR2RH13 | KR2RH5 | KR2RH6 | KR2R | |
| | Green | KR2GH13 | KR2GH5 | KR2GH6 | KR2G | |
| | Universal (1) | KR2UH13 | KR2UH5 | KR2UH6 | KR2U | |
| | Other (2) | KR2■H13 | KR2■H5 | KR2■H6 | KR2■ | |
|  9001KR4B 1-3/8 in (35 mm) Diameter Mushroom Button | Snap-In Plastic Mushroom Button | | | | | |
| | Black | KR4BH13 | KR4BH5 | KR4BH6 | KR4B | |
| | Red | KR4RH13 | KR4RH5 | KR4RH6 | KR4R | |
| | Red (3) | KR4R05H13 | KR4R05H5 | KR4R05H6 | KR4R05 | |
| | Green | KR4GH13 | KR4GH5 | KR4GH6 | KR4G | |
| | Other (4) | KR4★H13 | KR4★H5 | KR4★H6 | KR4★ | |
| | Screw-On Plastic Mushroom Button with Set Screw | | | | | |
| | Black | KR24BH13 | KR24BH5 | KR24BH6 | KR24B | |
| | Red | KR24RH13 | KR24RH5 | KR24RH6 | KR24R | |
| | Green | KR24GH13 | KR24GH5 | KR24GH6 | KR24G | |
| | Other (4) | KR24★H13 | KR24★H5 | KR24★H6 | KR24★ | |
| |  9001KR24BM 1-1/2 in (40 mm) Diameter Mushroom Button | Screw-in Metal Mushroom Button with Set Screw | | | | |
| | | Black | — | — | — | KR24BM |
| Red | | — | — | — | KR24RM | |
| Green | | — | — | — | KR24GM | |
|  9001KR5B 2-1/4 in (57 mm) Diameter Mushroom Button | Snap-In Plastic Mushroom Button | | | | | |
| | Black | KR5BH13 | KR5BH5 | KR5BH6 | KR5B | |
| | Red | KR5RH13 | KR5RH5 | KR5RH6 | KR5R | |
| | Red (3) | KR5R05H13 | KR5R05H5 | KR5R05H6 | KR5R05 | |
| | Green | KR5GH13 | KR5GH5 | KR5GH6 | KR5G | |
| | Other (4) | KR5★H13 | KR5★H5 | KR5★H6 | KR5★ | |
| | Screw-On Plastic Mushroom Button with Set Screw | | | | | |
| | Black | KR25BH13 | KR25BH5 | KR25BH6 | KR25B | |
| | Red | KR25RH13 | KR25RH5 | KR25RH6 | KR25R | |
| | Green | KR25GH13 | KR25GH5 | KR25GH6 | KR25G | |
| | Other (4) | KR25★H13 | KR25★H5 | KR25★H6 | KR25★ | |
| |  9001KR25BM 2-3/8 in (60 mm) Diameter Mushroom Button | Screw-in Metal Mushroom Button with Set Screw | | | | |
| | | Black | — | — | — | KR25BM |
| Red | | — | — | — | KR25RM | |
| | Green | — | — | — | KR25GM | |

(1) The universal push button operators contain one each of the following color inserts: black, red, green, yellow, orange, blue and white.
 (2) Replace ■ with the color code as chosen from the color code table below.
 (3) Knob has the words “Emergency Stop” in raised letters highlighted in white for readability.
 (4) Replace ★ with the color code as chosen from the color code table below.

Color Codes

| Color | KR1, 2, 3 Place Color Code in Reference ■ | KR4, 5, 24, 25 Place Color Code in Reference ★ |
|--------|---|--|
| Blue | L | L |
| Yellow | Y | Y |
| White | W | — |
| Orange | S | S |
| Gray | E | — |

To select and order Contact Blocks, Light Modules, Knobs, and Accessories, see pages 20 to 29.

Harmony™ 9001K/SK/KX

30 mm push buttons

9001K – Push buttons and mushroom operators

Note: When ordering, add prefix “9001” to the reference.

Illuminated Momentary Push Button Operators

For use in hazardous locations, see page 23.

Legend plate and contact block not included unless otherwise noted.

| Description | Voltage and Frequency | Style | With Red Color Cap and 1 N.O. and 1 N.C. Contact (KA1) (2) | With Green Color Cap and 1 N.O. and 1 N.C. Contact (KA1) (2) | With Other Color Cap Without Contact Block (1) (2) (5) |
|--|------------------------|-------------------------|--|--|--|
|  9001K1L1 Full Guard Illuminated Push Button Clear Plastic Top | 110–120 V, 50–60 Hz | Transformer | K1L1RH13 | K1L1GH13 | K1L1▼ |
| | 220–240 V, 50–60 Hz | Transformer | K1L7RH13 | K1L7GH13 | K1L7▼ |
| | 24–28 Vac/Vdc | Full Voltage | K1L35RH13 | K1L35GH13 | K1L35▼ |
| | For other voltages (2) | Transformer or Flashing | K1L■RH13 | K1L■GH13 | K1L■▼ |
| | | Full Voltage | K1L■RH13 | K1L■GH13 | K1L■▼ |
| | | Resistor or Neon (3) | K1L■RH13 | K1L■GH13 | K1L■▼ |
| LED (4) | K1L■RH13 | K1L■GH13 | K1L■▼ | | |
|  9001K3L1 Full Guard Illuminated Push Button Metal Top | 110–120 V, 50–60 Hz | Transformer | K3L1RH13 | K3L1GH13 | K3L1▼ |
| | 220–240 V, 50–60 Hz | Transformer | K3L7RH13 | K3L7GH13 | K3L7▼ |
| | 24–28 Vac/Vdc | Full Voltage | K3L35RH13 | K3L35GH13 | K3L35▼ |
| | For other voltages (2) | Transformer or Flashing | K3L■RH13 | K3L■GH13 | K3L■▼ |
| | | Full Voltage | K3L■RH13 | K3L■GH13 | K3L■▼ |
| | | Resistor or Neon (3) | K3L■RH13 | K3L■GH13 | K3L■▼ |
| LED (4) | K3L■RH13 | K3L■GH13 | K3L■▼ | | |
|  9001K2L1 No Guard Illuminated Push Button | 110–120 V, 50–60 Hz | Transformer | K2L1RH13 | K2L1GH13 | K2L1▼ |
| | 220–240 V, 50–60 Hz | Transformer | K2L7RH13 | K2L7GH13 | K2L7▼ |
| | 24–28 Vac/Vdc | Full Voltage | K2L35RH13 | K2L35GH13 | K2L35▼ |
| | For other voltages (2) | Transformer or Flashing | K2L■RH13 | K2L■GH13 | K2L■▼ |
| | | Full Voltage | K2L■RH13 | K2L■GH13 | K2L■▼ |
| | | Resistor or Neon (3) | K2L■RH13 | K2L■GH13 | K2L■▼ |
| LED (4) | K2L■RH13 | K2L■GH13 | K2L■▼ | | |
|  9001K2LR20 1-3/8 in (35 mm) Illuminated Screw-On Plastic Mushroom (no Set Screw) | 110–120 V, 50–60 Hz | Transformer | K2L1R20H13 | K2L1G20H13 | Order K2L■▼ above (6) |
| | 220–240 V, 50–60 Hz | Transformer | K2L7R20H13 | K2L7G20H13 | |
| | 24–28 Vac/Vdc | Full Voltage | K2L35R20H13 | K2L35G20H13 | |
| | For other voltages (2) | Transformer or Flashing | K2L■R20H13 | K2L■G20H13 | |
| | | Full Voltage | K2L■R20H13 | K2L■G20H13 | |
| | | Resistor or Neon (3) | K2L■R20H13 | K2L■G20H13 | |
| LED (4) | K2L■R20H13 | K2L■G20H13 | | | |
|  9001K2LR21 2-1/4 in (57 mm) Illuminated Screw-On Plastic Mushroom (no Set Screw) | 110–120 V, 50–60 Hz | Transformer | K2L1R21H13 | K2L1G21H13 | Order K2L■▼ above (6) |
| | 220–240 V, 50–60 Hz | Transformer | K2L7R21H13 | K2L7G21H13 | |
| | 24–28 Vac/Vdc | Full Voltage | K2L35R21H13 | K2L35G21H13 | |
| | For other voltages (2) | Transformer or Flashing | K2L■R21H13 | K2L■G21H13 | |
| | | Full Voltage | K2L■R21H13 | K2L■G21H13 | |
| | | Resistor or Neon (3) | K2L■R21H13 | K2L■G21H13 | |
| LED (4) | K2L■R21H13 | K2L■G21H13 | | | |

- (1) These operators can be ordered complete with contact blocks. For maximum block usage, see page 22. Add the “H” number chosen from page 22 to the end of the operator reference number and add the cost of the “H” number to the operator cost.
- (2) Replace ■ with the voltage assembly code as chosen from the tables on page 24. Example: K2L■ with 240 Vac/Vdc = K2L25
- (3) On neon light modules, use clear color caps only.
- (4) The cap must be the same color as the LED light module chosen, e.g., for red LED, use red color cap.
- (5) Replace ▼ with the color code as chosen from the color cap table below. Example: K2L25▼ with a blue 13/8 mushroom button = K2L25L20
- (6) The only difference between a no guard (K2L) operator and mushroom button operator is the color cap.

Color Caps

| Color | Color Codes | | |
|--------|-----------------|---------------------|---------------------|
| | ▼ K1L, K2L, K3L | ▼ 1-3/8 in Mushroom | ▼ 2-1/4 in Mushroom |
| Red | R | R20 | R21 |
| Green | G | G20 | G21 |
| Blue | L | L20 | L21 |
| Yellow | Y | Y20 | Y21 |
| White | W | W20 | W21 |
| Clear | C | C20 | C21 |
| Amber | A | A20 | A21 |

To select and order Contact Blocks, Light Modules, Knobs, and Accessories, see pages 20 to 29.

Harmony™ 9001K/SK/KX

30 mm push buttons

9001K – Multi-function operators

Note: When ordering, add prefix “9001” to the reference.

30 mm Multi-function Operators

Non-Illuminated Push-Pull Mushroom Operators

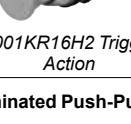
| Description (1) | Color | With 2 N.C. Contacts (1 KA3, 1 KA5) (2) | With 1 N.O. & 1 N.C. Contact (1 KA1) (2) | Without Contacts (2) (6) |
|--|---------|---|--|--------------------------|
|  9001KR9R94H13 Set Screw Style 3-Position Momentary Pull, Maintained Neutral, Momentary Push 1-5/8 in (40 mm) Screw-On Plastic Mushroom (no Set Screw) (8) | Red | KR8RH25 | — | KR8R |
| | Green | KR8GH25 | — | KR8G |
| | Other | KR8▲H25 | — | KR8▲ |
|  9001KR9RM94 2-Position, Maintained Pull, Maintained Push, 1-5/8 in (40 mm) Screw-On Plastic Mushroom (no Set Screw) (9) | Red (7) | — | KR9RH13 | KR9R |
| | Green | — | KR9GH13 | KR9G |
| | Other | — | KR9▲H13 | KR9▲ |
|  9001KR9RM95 2-Position, Maintained Pull, Maintained Push, 1-5/8 in (40 mm) Screw-On Plastic Mushroom (with Set Screw) (9) | Red | — | KR9R94H13 | KR9R94 |
| | Black | — | — | KR9BM94 |
| | Red | — | — | KR9RM94 |
|  9001KR9RM94 2-Position Maintained Pull, Maintained Push 1-5/8 in (40 mm) Screw-On Metal Mushroom (with Set Screw) | Green | — | — | KR9GM94 |
| | Black | — | — | KR9BM95 |
| | Red | — | — | KR9RM95 |
|  9001KR9RM95 2-Position Maintained Pull, Maintained Push 2-3/8 in (60 mm) Screw-On Metal Mushroom (with Set Screw) | Green | — | — | KR9GM95 |

Non-Illuminated Turn-To-Release Mushroom Operators

| Description | Color | With 1 N.O. & 1 N.C. Contact (KA1) | With 2 N.O. & 2 N.C. Contacts (KA2) | Without Contacts |
|---|-------|------------------------------------|-------------------------------------|------------------|
|  9001KR16H2 Trigger Action 2-Position Trigger-Action, Turn-to-Release 1-5/8 in. (40 mm) Non-Removal Plastic Mushroom Complies with EN418/ISO13850 standards for Emergency Stop push buttons when used with circular Legend Plate 9001KN8330 (90 mm diameter) or 9001KN9330 (60 mm diameter). See page 26. | Red | KR16H13 | KR16H2 | KR16 |

Illuminated Push-Pull Mushroom Operators

| Description (1) | Voltage | With Red Knob and 2 N.C. Contacts (1 KA3, 1 KA5) (3) | With Other Color Knob and 2 N.C. Contacts (1 KA3, 1 KA5) (2) (3) | With Other Color Knob Without Contacts (2) (3) (6) |
|---|--|--|--|--|
|  9001KR9P1 1-5/8 in Diameter Knob with “Pull To Start / Push To Stop” 9001KN379 Legend Plate For 1-3/8 in or 2-1/4 in Diameter Knob (1) | 3-Position Illuminated Momentary Pull | 110-120 V, 50-60 Hz | KR8P1RH25 | KR8P1▲H25 |
| | Maintained Neutral | Other - Transformer, LED, Flashing (4) | KR8P■RH25 | KR8P■▲H25 |
| | Momentary Push (8) | Other - Full Voltage, Resistor, Neon (5) | KR8P■RH25 | KR8P■▲H25 |
| 2-Position Illuminated Maintained Pull Maintained Push (9) | 110-120 V, 50-60 Hz | KR9P1RH13 | KR9P1▲H13 | KR9P1▲ |
| | Other - Transformer, LED, Flashing (4) | KR9P■RH13 | KR9P■▲H13 | KR9P1▲ KR9P1▲ |
| | Other - Full Voltage, Resistor, Neon (5) | KR9P■RH13 | KR9P■▲H13 | KR9P1▲ KR9P1▲ |

- (1) For 1-3/8 in or 2-1/4 in dia. knob:
 - a) Order Type -20 or -21 knob from page 28.
 - b) Order 9001K54 adapter (no charge)—allows Type -20 or -21 knob to fit on push pull operators. Voids UL and NEMA 6 rating.
 - c) Can order assembled operator by adding color code to Type -20 or -21. Example: 9001KR9R would be 9001KR9R20 or 9001KR9R21.
- (2) Replace ▲ with the color code as chosen from the color code table below. Example: KR9▲ with a yellow knob = KR9Y
- (3) Replace ■ with the voltage assembly code as chosen from the tables on page 24. Example: KR8P■ with a 277 V 50-60 Hz voltage = KR8P8
- (4) The knob must be the same color as the LED light module chosen, for example, for a green LED, use a green knob.
- (5) On neon light modules, use clear knobs only.
- (6) These operators can be ordered complete with contact blocks. For maximum block usage, see page 22. Add the “H” number chosen from page 22 to the end of the operator reference number.
- (7) To obtain a red knob with “Push Emergency Stop” printed on the red knob, substitute “R05” in place of “R”.
- (8) See page 16 for contact sequences.
- (9) See table below.

Other Color Code Selection

| Color | KR6, KR7, KR67 | KR11, KR12 | KR8, KR9 | Color | KR6, KR7, KR67 | KR11, KR12 | KR8, KR9 |
|-------------|----------------|------------|--------------|-------|----------------|------------|----------|
| Black (1) B | B | B | White | — | W | W | |
| Red R | R | R | Orange (1) — | — | S | S | |
| Green G | G | G | Clear | — | — | C | |
| Blue | L | L | Amber | — | — | A | |
| Yellow | — | Y | Gray | — | E | — | |

(1) These colors are not available on illuminated push-pull operators.

To select and order Contact Blocks, Light Modules, Knobs, and Accessories, see pages 20 to 29.

Contact Sequences

| 9001KR8RH1 or H13 | | | | |
|-------------------|-----|------|-----|------|
| | | Pull | Ctr | Push |
| (KA1) | KA3 | x | O | O |
| | KA2 | O | O | x |
| 9001KR8RH25 | | | | |
| KA3 | | x | O | O |
| KA5 | | x | x | O |
| KA2 | | O | O | x |

O = contact open; x = contact closed

Harmony™ 9001K/SK/KX

30 mm push buttons

9001K – Selector switches

Note: When ordering, add prefix “9001” to the reference.

2-Position Selector Switches

| Contact Block Required | | | | 1 — Contact Closed | | 0 — Contact Open | | | | | |
|--------------------------|-------------------------------------|-----|---------------------------------|--------------------|--------|------------------|--------|-------|---|---|---|
| Contact Block Position | Quantity and Type KA1 or KA2 or KA3 | | Mount on Side KA1 or KA2 or KA3 | | Left | Right | Left | Right | | | |
| | <p>Top View</p> | KA1 | or | KA3 | KA1 #2 | or | KA3 #2 | 1 | 0 | 0 | 1 |
| | | | KA2 | | | KA2 #2 | 0 | 1 | 1 | 0 | |
| KA1 | | or | KA3 | KA1 #1 | or | KA3 #1 | 1 | 0 | 0 | 1 | |
| | | | KA2 | | | KA2 #1 | 0 | 1 | 1 | 0 | |
| Cam (see page 16) | | | | E | | D | | | | | |

Non-Illuminated Operators

| Manual Return (1), Operator Only (without contact blocks) | Reference | Reference |
|---|------------------|------------------|
| Without Knob | KS11 | KS12 |
| With Knob (select style and color from table below) | KS11 | KS12 |
| Key Operated with E10 Key (Code 1,2,3) | KS11K | KS12K |
| Operator with Contact Blocks and Standard black knob | Reference | Reference |
| With 1 KA1 on Side #2 | KS11BH13 | — |
| With 1 KA1 on Side #1 | KS11BH1 | — |
| With 1 KA1 on Side #1 and 1 KA1 on side #2 | KS11BH2 | — |
| Spring Return from Left (1), Operator Only (without contact blocks) | Reference | Reference |
| Without Knob | KS25 | — |
| With Knob (select style and color from table below) | KS25 | — |
| Key Operated with E10 Key (Code 2 only) (4) | KS25K2★ | — |
| Spring Return from Right (1), Operator Only (without contact blocks) | Reference | Reference |
| Without Knob | — | KS34 |
| With Knob (select style and color from table below) | — | KS34 |
| Key Operated with E10 Key (Code 1 only) | — | KS34K1 |

Illuminated Operators

| Manual Return (1), Operator Only (without contact blocks) | Reference | Reference |
|---|------------------|------------------|
| Without Knob, 110-120V 50-60 Hz Transformer | K11J1 | K12J1 |
| With Standard Red Knob, 110-120V 50-60 Hz Transformer | K11J1R | K12J1R |
| With Other Color Knob and other voltage Light Module (2) (3) | K11J■◆ | K12J■◆ |
| Spring Return from Left (1), Operator Only (without contact blocks) | Reference | Reference |
| Without Knob, 110-120V 50-60 Hz Transformer | K25J1 | — |
| With Standard Red Knob, 110-120V 50-60 Hz Transformer | K25J1R | — |
| With Other Color Knob and other voltage Light Module (2) (3) | K25J■◆ | — |
| Spring Return from Right (1), Operator Only (without contact blocks) | Reference | Reference |
| Without Knob, 110-120V 50-60 Hz Transformer | — | K34J1 |
| With Standard Red Knob, 110-120V 50-60 Hz Transformer | — | K34J1R |
| With Other Color Knob and other voltage Light Module (2) (3) | — | K34J■◆ |

(1) These operators can be ordered complete with contact blocks. Add the “H code” from page 21 as needed for your application.
 (2) Replace ■ with the voltage assembly code as chosen from the tables on page 24. Example: K25J■ with 208 Vac = K25J3.
 (3) Replace ◆ with the knob color code as chosen from the table below. For LED, knob color must match LED.
 (4) Replace ★ with the key withdrawal code from the table below right.

Selector Switch Assembly Code and Knob Cat. No.

| Color | Standard Knob | | Gloved Hand Knob | |
|--------|---------------|-----------|------------------|-----------|
| | ◆ Knob Code | Reference | ◆ Knob Code | Reference |
| Black | B | B11 | FB | B25 |
| Red | R | R8 | FR | R24 |
| Green | G | G8 | FG | G24 |
| Yellow | Y | Y8 | FY | Y24 |
| Blue | L | L8 | FL | L24 |
| White | W | W8 | FW | W24 |
| Amber | A | A8 | FA | A24 |
| Clear | C | C8 | FC | C24 |

Key Withdrawal Codes

| ★ Code | Position |
|--------|----------------|
| 1 | Left Only |
| 2 | Right Only |
| 3 | Left and Right |



To select and order Contact Blocks, Light Modules, Knobs, and Accessories, see pages 20 to 29.

Harmony™ 9001K/SK/KX

30 mm push buttons

9001K – Selector switches

Note: When ordering, add prefix “9001” to the reference.

3-Position Selector Switches

| Contact Block Required | | | 1 — Contact Closed 0 — Contact Open | | | | | | | | | |
|--------------------------|---------------|--------|-------------------------------------|----------|----------|----------|----------|----------|----------|----------|----------|--|
| Quantity and Type | Mount on Side | Center | Center | Center | Center | Center | Center | Center | Center | Center | Center | |
| Position | Type | Left | Right | Left | Right | Left | Right | Left | Right | Left | Right | |
| | KA1 or KA3 #2 | 0 | 0 | 0 | 0 | 0 | 0 | 0 | 0 | 0 | 0 | |
| | KA2 #2 | 0 | 1 | 1 | 0 | 0 | 1 | 0 | 0 | 1 | 0 | |
| | KA1 or KA3 #1 | 0 | 0 | 1 | 1 | 0 | 0 | 0 | 1 | 0 | 0 | |
| | KA2 #1 | 1 | 1 | 0 | 0 | 0 | 1 | 0 | 0 | 1 | 0 | |
| Cam (see page 16) | | | B | C | D | E | F | G | J | L | M | |

Non-Illuminated Operators

| Manual Return, Operator Only (without contact blocks) (1) | | | | | | | | | |
|---|----------|----------|----------|----------|----------|----------|----------|-----------|-----------|
| Without Knob | KS42 | KS43 | KS44 | KS45 | KS46 | KS47 | KS49 | KS401 | KS402 |
| With Knob (3) | KS42♦ | KS43♦ | KS44♦ | KS45♦ | KS46♦ | KS47♦ | KS49♦ | KS401♦ | KS402♦ |
| Key Operated with E10 Key (Code 4 through 10) (5) | KS42K▼ | KS43K▼ | KS44K▼ | KS45K▼ | KS46K▼ | KS47K▼ | KS49K▼ | KS401K▼ | KS402K▼ |
| Operator with Contact Blocks and Standard black knob (4) | | | | | | | | | |
| With 1 KA1 on Side #2 (H13) | KS42BH13 | KS43BH13 | KS44BH13 | KS45BH13 | KS46BH13 | KS47BH13 | KS49BH13 | KS401BH13 | KS402BH13 |
| With 1 KA1 on Side #1 (H1) | KS42BH1 | KS43BH1 | KS44BH1 | KS45BH1 | KS46BH1 | KS47BH1 | KS49BH1 | KS401BH1 | KS402BH1 |
| With 1 KA1 on Side #1 and 1 KA1 on side #2 (H2) | KS42BH2 | KS43BH2 | KS44BH2 | KS45BH2 | KS46BH2 | KS47BH2 | KS49BH2 | KS401BH2 | KS402BH2 |
| Spring Return from Left to Center, Operator Only (without contact blocks) (1) | | | | | | | | | |
| Without Knob | KS62 | KS63 | KS64 | KS65 | KS66 | KS67 | KS69 | KS601 | KS602 |
| With Knob (3) | KS62♦ | KS63♦ | KS64♦ | KS65♦ | KS66♦ | KS67♦ | KS69♦ | KS601♦ | KS602♦ |
| Key Operated with E10 Key (Code 5, 6 or 9 only) (5) | KS62K▼ | KS63K▼ | KS64K▼ | KS65K▼ | KS66K▼ | KS67K▼ | KS69K▼ | KS601K▼ | KS602K▼ |
| Spring Return from Right to Center, Operator Only (without contact blocks) (1) | | | | | | | | | |
| Without Knob | KS72 | KS73 | KS74 | KS75 | KS76 | KS77 | KS79 | KS701 | KS702 |
| With Knob (3) | KS72♦ | KS73♦ | KS74♦ | KS75♦ | KS76♦ | KS77♦ | KS79♦ | KS701♦ | KS702♦ |
| Key Operated with E10 Key (Code 4, 5 or 7 only) (5) | KS72K▼ | KS73K▼ | KS74K▼ | KS75K▼ | KS76K▼ | KS77K▼ | KS79K▼ | KS701K▼ | KS702K▼ |
| Spring Return from Both Sides to Center, Operator Only (without contact blocks) (1) | | | | | | | | | |
| Without Knob | KS52 | KS53 | KS54 | KS55 | KS56 | KS57 | KS59 | KS501 | KS502 |
| With Knob (3) | KS52♦ | KS53♦ | KS54♦ | KS55♦ | KS56♦ | KS57♦ | KS59♦ | KS501♦ | KS502♦ |
| Key Operated with E10 Key (Code 4, 5 or 7 only) (5) | KS52K▼ | KS53K▼ | KS54K▼ | KS55K▼ | KS56K▼ | KS57K▼ | KS59K▼ | KS501K▼ | KS502K▼ |

Illuminated Operators

| Manual Return, Operator Only (without contact blocks) (1) | | | | | | | | | |
|---|--------|--------|--------|--------|--------|--------|--------|---------|---------|
| Without Knob, 110-120V 50-60 Hz Transformer | K42J1 | K43J1 | K44J1 | K45J1 | K46J1 | K47J1 | K49J1 | K401J1 | K402J1 |
| With Standard Red Knob, 110-120V 50-60 Hz Transformer | K42J1R | K43J1R | K44J1R | K45J1R | K46J1R | K47J1R | K49J1R | K401J1R | K402J1R |
| With Other Color Knob and other voltage Light Module (2) (3) | K42J■♦ | K43J■♦ | K44J■♦ | K45J■♦ | K46J■♦ | K47J■♦ | K49J■♦ | K401J■♦ | K402J■♦ |
| Spring Return from Left to Center, Operator Only (without contact blocks) (1) | | | | | | | | | |
| Without Knob, 110-120V 50-60 Hz Transformer | K62J1 | K63J1 | K64J1 | K65J1 | K66J1 | K67J1 | K69J1 | K601J1 | K602J1 |
| With Standard Red Knob, 110-120V 50-60 Hz Transformer | K62J1R | K63J1R | K64J1R | K65J1R | K66J1R | K67J1R | K69J1R | K601J1R | K602J1R |
| With Other Color Knob and other voltage Light Module (2) (3) | K62J■♦ | K63J■♦ | K64J■♦ | K65J■♦ | K66J■♦ | K67J■♦ | K69J■♦ | K601J■♦ | K602J■♦ |
| Spring Return from Right to Center, Operator Only (without contact blocks) (1) | | | | | | | | | |
| Without Knob, 110-120V 50-60 Hz Transformer | K72J1 | K73J1 | K74J1 | K75J1 | K76J1 | K77J1 | K79J1 | K701J1 | K702J1 |
| With Standard Red Knob, 110-120V 50-60 Hz Transformer | K72J1R | K73J1R | K74J1R | K75J1R | K76J1R | K77J1R | K79J1R | K701J1R | K702J1R |
| With Other Color Knob and other voltage Light Module (2) (3) | K72J■♦ | K73J■♦ | K74J■♦ | K75J■♦ | K76J■♦ | K77J■♦ | K79J■♦ | K701J■♦ | K702J■♦ |
| Spring Return from Both Sides to Center, Operator Only (without contact blocks) (1) | | | | | | | | | |
| Without Knob, 110-120V 50-60 Hz Transformer | K52J1 | K53J1 | K54J1 | K55J1 | K56J1 | K57J1 | K59J1 | K501J1 | K502J1 |
| With Standard Red Knob, 110-120V 50-60 Hz Transformer | K52J1R | K53J1R | K54J1R | K55J1R | K56J1R | K57J1R | K59J1R | K501J1R | K502J1R |
| With Other Color Knob and other voltage Light Module (2) (3) | K52J■♦ | K53J■♦ | K54J■♦ | K55J■♦ | K56J■♦ | K57J■♦ | K59J■♦ | K501J■♦ | K502J■♦ |

(1) These operators can be ordered complete with contact blocks. Add the “H code” from page 21 as needed for your application.
 (2) Replace ■ with the voltage assembly code as chosen from the tables on page 24. Example: K25J■ with 208 Vac = K25J3.
 (3) Replace ♦ with the knob color code as chosen from the table below. For LED, knob color must match LED.
 (4) For other color knobs replace the B with knob color code from table below.
 (5) Replace ▼ with the key withdrawal code from table below right. Example: KS43K▼ with key withdrawal in the right position only = KS43K6.

Selector Switch Assembly Code and Knob Cat. No.

| Color | Standard Knob | | Gloved Hand Knob | |
|--------|---------------|-----------|------------------|-----------|
| | ♦ Knob Code | Reference | ♦ Knob Code | Reference |
| Black | B | B11 | FB | B25 |
| Red | R | R8 | FR | R24 |
| Green | G | G8 | FG | G24 |
| Yellow | Y | Y8 | FY | Y24 |
| Blue | L | L8 | FL | L24 |
| White | W | W8 | FW | W24 |
| Amber | A | A8 | FA | A24 |
| Clear | C | C8 | FC | C24 |

Key Withdrawal Codes

| ▼ Code | Position |
|--------|-------------------------|
| 4 | Left Only |
| 5 | Center Only |
| 6 | Right Only |
| 7 | Left and Center |
| 8 | Left and Right |
| 9 | Center and Right |
| 10 | Left, Center, and Right |

To select and order Contact Blocks, Light Modules, Knobs, and Accessories, see pages 20 to 29.



Note: When ordering, add prefix “9001” to the reference.

| 4-Position Selector Switches | | | 1 — Contact Closed 0 — Contact Open | | |
|------------------------------|--|------------------------------------|-------------------------------------|-----------|---------|
| Contact Block Required | | | | | |
| Contact Block Position | Quantity and Type KA1 or KA2 or KA3 | Mount on Side KA1 or KA2 or KA3 | | | |
| <p>Top View</p> | KA1 | or KA3 | KA1 #2 | or KA3 #2 | 1 0 0 0 |
| | | KA2 | KA2 #2 | | 0 0 1 0 |
| | KA1 | or KA3 | KA1 #1 | or KA3 #1 | 0 0 0 1 |
| | | KA2 | KA2 #1 | | 0 1 0 0 |
| Cam (see page 16) | | | H | | |

| Non-Illuminated Operators | | Reference |
|--|--|-----------|
| Manual Return (1), Operator Only (without contact blocks) | | |
| Without Knob | | KS88 |
| With Knob (3) | | KS88♦ |
| Key Operated with E10 Key (Codes 11, 12, 13, 14, 15) (4) | | KS88K★ |

| Illuminated Operators | | Reference |
|--|--|-----------|
| Manual Return (1), Operator Only (without contact blocks) | | |
| Without Knob, 110-120V 50-60 Hz Transformer | | KS88J1 |
| With Standard Red Knob, 110-120V 50-60 Hz Transformer | | KS88J1R |
| With Other Color Knob and other voltage Light Module (2) (3) | | KS88J■♦ |

(1) These operators can be ordered complete with contact blocks. Add the “H code” from page 21 as needed for your application.
 (2) Replace ■ with the voltage assembly code as chosen from the tables on page 24. Example: K25Jb with 208Vac = K25J3.
 (3) Replace ♦ with the knob color code as chosen from the table below. For LED, knob color must match LED.
 (4) Replace ★ with the key withdrawal code from the table below right.

| Selector Switch Assembly Code and Knob Cat. No. | | | | |
|---|---------------|-----------|------------------|-----------|
| Color | Standard Knob | | Gloved Hand Knob | |
| | ◆ Knob Code | Reference | ◆ Knob Code | Reference |
| Black | B | B11 | FB | B25 |
| Red | R | R8 | FR | R24 |
| Green | G | G8 | FG | G24 |
| Yellow | Y | Y8 | FY | Y24 |
| Blue | L | L8 | FL | L24 |
| White | W | W8 | FW | W24 |
| Amber | A | A8 | FA | A24 |
| Clear | C | C8 | FC | C24 |

| Key Withdrawal Codes | |
|----------------------|---------------|
| ★ Code | Position |
| 11 | 1 and 4 |
| 12 | 4 only |
| 13 | 1 only |
| 14 | 1, 2, 3 and 4 |
| 15 | 2, 3, and 4 |



| Potentiometers with Dial Plate (not UL listed)—Maximum Voltage 300 Vac | | | | |
|--|-------|---|------------|-----------|
| | Power | Description | Ratings | Reference |
| | 2 W | Operator Only, for Single Potentiometer | NEMA 4, 13 | K20 |
| | | Operator with Single Potentiometer | | K21 |
| | | Operator Only, for Tandem Potentiometer | | K22 |
| | | Operator with Tandem Potentiometer | | K23 |

| Potentiometer Suffixes | | | |
|------------------------|------------|------------|------------|
| Single Potentiometer | | | |
| Suffix (5) | Resistance | Suffix (5) | Resistance |
| 01 | 50 Ω | 07 | 5 kΩ |
| 02 | 100 Ω | 08 | 10 kΩ |
| 04 | 500 Ω | 09 | 25 kΩ |
| 05 | 1 kΩ | 13 | 500 kΩ |
| 39 | 2 kΩ | 37 | 750 kΩ |
| 06 | 2.5 kΩ | 14 | 1 MΩ |
| Tandem Potentiometer | | | |
| Suffix (5) | Resistance | | |
| | Front | Rear | |
| 82 | 1 kΩ | 1 kΩ | |

(5) For the complete reference, add the suffix from Suffix column to the reference from Reference column in “Potentiometer with Dial Plate” table above. Example: 9001 K21 05.
 Any potentiometer with a shaft 7/8" long and 1/4" diameter may be used with these operators. To select and order Contact Blocks, Light Modules, Knobs, and Accessories, see pages 20 to 29.

Harmony™ 9001K/SK/KX

30 mm push buttons

9001K – Selector switch guide

Note: When ordering, add prefix “9001” to the reference.

Shown below is a simplified method of selecting a selector switch to meet almost any combination of contact sequences.

Step No. 1

Determine the contact sequence(s) required. Set up a target table like the one shown for the example below.

| Contact Sequence | 0—contact open | 1—contact closed | ↖ | ↑ | ↗ |
|------------------|----------------|------------------|---|---|---|
| A | | | 1 | 0 | 0 |
| B | | | 0 | 1 | 0 |
| C | | | 0 | 0 | 1 |

Step No. 2

Look for a cam type common to all sequences in the three tables to the right. For the example above, the “3-Position Selector Switch” table would be used. For the contact sequences A (1 0 0), B (0 1 0) and C (0 0 1) of the example above, cam types F and L are common to all three sequences.

Step No. 3

Next, use the cam type common to all the sequences (if several cam types are common, choose one) to find the operator reference number. Go to the proper page number as indicated in the table below:

| Number of Positions | Push Button Line | Page Number |
|---------------------|------------------|-------------|
| 2 | 9001KS | 13 |
| 3 | 9001KS | 14 |
| 4 | 9001KS | 15 |

If for the example above a manual return operator with a standard black knob is required and:

The F cam type is chosen, the operator reference number is:

- 9001K—Class 9001 Reference KS46B (from page 14)

The L cam type is chosen, the operator reference number is:

- 9001K—Class 9001 Reference KS401B (from page 14)

Step No. 4

Determine the contact blocks required by using the same table in Step No. 2.

If, for the example above, the F cam type is chosen:

- Use a 9001KA3 mounted on side no. 2 for sequence A (1 0 0).
- Use a 9001KA3 mounted on side no. 1 for sequence B (0 1 0).
- Use a 9001KA2 mounted on side no. 1 or 2 for sequence C (0 0 1).

If, for the example above, the L cam type is chosen:

- Use a 9001KA2 mounted on side no. 2 for sequence A (1 0 0).
- Use a 9001KA2 mounted on side no. 1 or a 9001KA3 mounted on side no. 2 for sequence B (0 1 0).
- Use a 9001KA3 mounted on side no. 1 for sequence C (0 0 1).

One 9001KA1 double circuit block can be used in place of one 9001KA2 single circuit block plus one 9001KA3 single circuit block mounted on the same side.

2-Position Selector Switch

| If you require contact sequence— | Use Cam Type | Use Contact Block Reference | Mount on side no. (See page 21) |
|----------------------------------|--------------|-----------------------------|---------------------------------|
| 1 0 | E | KA3 | 1 or 2 |
| | D | KA2 | 1 or 2 |
| 0 1 | E | KA2 | 1 or 2 |
| | D | KA3 | 1 or 2 |

3-Position Selector Switch

| If you require contact sequence— | Use Cam Type | Use Contact Block Reference | Mount on side no. (See page 21) |
|----------------------------------|--------------|-----------------------------|---------------------------------|
| 1 0 0 | G | KA2 | 1 |
| | L | KA2 | 2 |
| | C | KA3 | 1 |
| | B C | KA3 | 2 |
| | B | KA5(1) | 2 |
| 0 1 0 | D E | KA2 | 1 |
| | D E | KA2 | 2 |
| | F | KA3 | 1 |
| | L | KA3 | 2 |
| 0 0 1 | C | KA2 | 1 or 2 |
| | B D | KA3 | 1 |
| | D | KA3 | 2 |
| | B | KA5(1) | 1 |
| | M | KA2 | 2 |
| 1 1 0 | B | KA2 | 1 |
| | C | KA5(1) | 1 or 2 |
| | F | KA3 | 2 |
| 0 1 1 | B | KA2 | 2 |
| | G J | KA5(1) | 1 |
| | G | KA5(1) | 2 |
| | L | KA3 | 1 |
| | M | KA3 | 1 |
| 1 0 1 | D E | KA5(1) | 1 |
| | D E | KA5(1) | 2 |

4-Position Selector Switch

| If you require contact sequence— | Use Cam Type | Use Contact Block Reference | Mount on side no. (See page 21) |
|----------------------------------|--------------|-----------------------------|---------------------------------|
| 1 0 0 0 | H | (A) KA3 | 2 |
| 0 1 0 0 | H | (B) KA2 | 1 |
| 0 0 1 0 | H | (C) KA2 | 2 |
| 0 0 0 1 | H | (D) KA3 | 1 |
| 1 0 0 1 | H | A & D Wired in Parallel | |
| 1 1 0 0 | H | A & B Wired in Parallel | |
| 0 1 1 0 | H | B & C Wired in Parallel | |
| 0 0 1 1 | H | C & D Wired in Parallel | |
| 1 1 1 0 | H | A, B & C Wired in Parallel | |
| 0 1 1 1 | H | B, C & D Wired in Parallel | |
| 1 0 1 0 | H | A & C Wired in Parallel | |
| 0 1 0 1 | H | B & D Wired in Parallel | |
| 1 1 0 1 | H | KA5(1) | 2 |
| 1 0 1 1 | H | KA5(1) | 1 |

(1) 9001KA5 must be the last block on either side.

$$KA1 = KA3 + KA2$$



When ordering, please specify:

- Quantity
- Class Number
- Type or Reference

For “H” Numbers, see page 22.

Harmony™ 9001K/SK/KX

30 mm push buttons

9001K – Pilot lights

Note: When ordering, add prefix “9001” to the reference.

Pilot Lights—UL Types 4, 13/NEMA 4 & 13
For use in hazardous locations, see page 23.
Legend plates not included.

| Description | Voltage | Style | With Red Fresnel Color Cap (1) | With Green Fresnel Color Cap (1) | With Other Color Cap (1) (2) | Without Color Cap (1) |
|--|---|--|--------------------------------|----------------------------------|------------------------------|-----------------------|
|  Standard Pilot Light (Plastic Fresnel Color Cap Shown) | 110–120 V, 50–60 Hz 220–240 V, 50–60 Hz 24–28 Vac/Vdc | Transformer Transformer Full Voltage | KP1R31 KP7R31 KP35R31 | KP1G31 KP7G31 KP35G31 | KP1■ KP7■ KP35■ | KP1 KP7 KP35 |
| | For other voltages see page 24. | Transformer, Flashing or LED (3) Full Voltage, Neon or Resistor (4) | KP▲R31 KP▲R31 | KP▲G31 KP▲G31 | KP▲■ KP▲■ | KP▲ KP▲ |
|  Push-To-Test Pilot Light (Glass Color Cap Shown) | 110–120 V, 50–60 Hz 220–240 V, 50–60 Hz 24–28 Vac/Vdc | Transformer Transformer Full Voltage | KT1R31 KT7R31 KT35R31 | KT1G31 KT7G31 KT35G31 | KT1■ KT7■ KT35■ | KT1 KT7 KT35 |
| | For other voltages see page 24. | Transformer, Flashing or LED (3) Full Voltage, Neon or Resistor (4) | KT▲R31 KT▲R31 | KT▲G31 KT▲G31 | KT▲■ KT▲■ | KT▲ KT▲ |
|  Remote Test Pilot Light (Glass Color Cap Shown) | 120 Vac Only 24–28 Vac Only for other voltages | Resistor (5) Full Voltage (5) | KTR38R31 KTR35R31 | KTR38G31 KTR35G31 | KTR38■ KTR35■ | KTR38 KTR35 |
| | For other voltages see page 24. | Full Voltage or Resistor (5) | KTR▲R31 | KTR▲G31 | KTR▲■ | KTR▲ |

(1) Replace ▲ with the voltage assembly code as chosen from the tables on page 24. Example: KT▲R31 with 208 Vac red LED = KT37LRR31
 (2) Replace ■ with the color code as chosen from the color code table below. Example: KP1■ with a blue fresnel cap = KP1L31
 (3) The cap must be the same color as the LED light module chosen, e.g., for green LED, use green color cap.
 (4) On neon light modules, use clear color caps only.
 (5) On remote test pilot lights use only full voltage or resistor voltage assembly codes. Do not choose LED, neon or transformer codes. For AC use only.

Color Caps

| Color | ■ Plastic Fresnel | ■ Plastic Domed | ■ Glass |
|--------|-------------------|-----------------|---------|
| Amber | A31 | A9 | A6 |
| Blue | L31 | L9 | L6 |
| Clear | C31 | C9 | C6 |
| Green | G31 | G9 | G6 |
| Red | R31 | R9 | R6 |
| White | W31 | W9 | W6 |
| Yellow | Y31 | Y9 | Y6 |

Typical Wiring Diagrams



Push-to-test Pilot Light



Remote Test Pilot Light

Harmony™ 9001K/SK/KX

30 mm push buttons

9001K – Specialty operators

Note: When ordering, add prefix “9001” to the reference.



Without Latch

Joy Stick Operators—UL Types 4, 13/NEMA 4, 13. For use in hazardous locations, see page 23. Contact blocks and legend plate not included unless noted.

| Description | Operator With Contacts | Operator Without Contacts (1) |
|--------------------------------|---------------------------------------|-------------------------------|
| ↕ 3-Position— Center Off | Momentary Contact— Without Latch | K71H7 |
| | Spring Return to Center With Latch | K70H7 |
| | Maintained Contact Without Latch | K73H7 |
| ↔ 3-Position— Center Off | Momentary Contact— Without Latch | K31H8 |
| | Spring Return to Center With Latch | K30H8 |
| | Maintained Contact Without Latch | K33H8 |
| ⬠ 5 Position— Center Off | Momentary Contact— Without Latch | K35H2 |
| | Spring Return to Center With Latch | K34H2 |
| | Maintained Contact Without Latch | K37H2 |
| | With Latch | K36H2 |

(1) These operators can be ordered complete with contact blocks—a total of four (4) contact blocks can be used. Add the “H” number chosen from page 21 to the operator reference number and add the cost of the “H” number to the operator cost.



With Latch

Contact Arrangements

| Operator Positions | Contact Block Reference | Contact Block Location | Contact | Handle position (with reference to Nib) | | | | |
|--------------------|-------------------------|------------------------|-----------|---|-----|-----|-----|-----|
| | | | | 1 ↑ | 2 → | OFF | 3 ↓ | 4 ← |
| ↔ | K3 | POS 1 (3) | A | — | 1 | 0 | — | 0 |
| | | KA3 | POS 2 (4) | A | — | 0 | 0 | — |
| ↕ | KA2 | POS 1 (3) | B | 1 | — | 0 | 0 | — |
| | | KA2 | POS 2 (4) | B | 0 | — | 0 | 1 |
| ⬠ | KA1 | POS 1 (3) | A | 0 | 1 | 0 | 0 | 0 |
| | | | B | 1 | 0 | 0 | 0 | 0 |
| | KA1 | POS 2 (4) | A | 0 | 0 | 0 | 0 | 1 |
| | | | B | 0 | 0 | 0 | 1 | 0 |

The joy stick operator is ideal for applications where only one circuit is to be energized at one time. The three position joy stick closes one circuit in each Up-Down or Right-Left position with all circuits open in center position. The five position operator closes one circuit in each Up, Down, Left and Right position with all circuits open in center position.

Momentary contact operators are spring return to the center position. Maintained operators remain in position and must be returned manually. Operators with latch cannot be operated until the latch button in center of handle is pressed.

(1) Contact Closed (0) Contact Open

For use in hazardous locations, see page 23. Legend plate and contact block not included. Inserts are field convertible. For colors not listed, order operator without insert, plus separate color insert from page 28. Up to two 9001KA contact blocks can be mounted in tandem (total of four blocks). Selector push buttons cannot be illuminated.



Selector Push Button 9001KQ

Selector Push Button Operators—UL Types 4, 13/NEMA 4, 13

| Contact Block Required (4) | Mount on Side | Two Position Operators | | | | | | | | | | | |
|----------------------------|---------------|------------------------|---|-------|---|------------------|---|-------|---|--------------------|---|-------|---|
| | | 0—Contact Open | | | | 1—Contact Closed | | | | F—Free D—Depressed | | | |
| Quantity and Type | | Left | | Right | | Left | | Right | | Left | | Right | |
| | | F | D | F | D | F | D | F | D | F | D | F | D |
| 1 KA1 ⬠ ○ | #2 | 0 | 0 | 1 | 0 | 0 | 0 | 1 | 0 | 0 | 0 | 1 | 1 |
| | | 0 | 1 | 0 | 1 | 0 | 1 | 0 | 0 | 0 | 0 | 0 | 1 |
| 1 KA1 ⬠ ○ | #1 | 0 | 0 | 1 | 1 | 0 | 0 | 1 | 1 | 0 | 0 | 1 | 1 |
| | | 0 | 1 | 0 | 0 | 0 | 1 | 0 | 0 | 0 | 0 | 1 | 0 |
| Cam (3) | | P | | | | R | | | | S | | | |
| Color Insert | | Reference | | | | Reference | | | | Reference | | | |
| Without Insert (2) Black | | KQ11 | | | | KQ12 | | | | KQ13 | | | |
| | | KQ11B | | | | KQ12B | | | | KQ13B | | | |
| | | KQ14B | | | | KQ15B | | | | | | | |

(2) Order color inserts from page 28.

(3) Cams are not interchangeable.

(4) To order Contact Blocks, see pages 20 to 23.

For use in hazardous locations, see page 23. Key operated push buttons are used wherever unauthorized use of a push button is discouraged. Examples are locking a Start push button in the extended position or locking a Stop push button in the depressed position. The operator can also be locked in the flush position—holding all contacts open. Up to two 9001KA contact blocks can be mounted in tandem (total of four blocks). Legend Plate and Contact Block Not Included (“x” = locked position).



Key Operated Push Button 9001KR

Key Operated Push Button – UL Types 4, 13/NEMA 4, 13

| Description | Lockable Positions | | | Reference |
|---|--------------------|-------|-----------|--|
| | Extended | Flush | Depressed | |
| Push button operable only with key in lock. Key is removable in locked position only. | x | — | — | KR131 KR132 KR133 KR137 |
| Push button operable with or without key in lock. Push button can be locked with key only. Key removable in both locked or unlocked position. | x | — | — | KR141 KR142 KR143 KR147 |
| To lock the unit, rotate the key with the button in the extended position. Then, push the button to lock it in the position indicated at right. Key is removable only in this position. | — | x | — | KR152 KR153 |

Note: All key operated push buttons are furnished as standard with Square D no. E10 key change. See catalog 9001CT0001 for other key changes.

Harmony™ 9001K/SK/KX

30 mm push buttons

9001K – Specialty operators

Note: When ordering, add prefix “9001” to the reference.

Illuminated and Non-Illuminated Dual Operators

Meets UL Type 13/NEMA 13 and UL Type 6/NEMA 6, which UL and NEMA consider an equivalent to UL Type 4/NEMA 4. For use in hazardous locations, see page 23. Legend plate and contact blocks not included unless otherwise noted.



9001KR7U



9001KR11U

| Description | Color | With 2 N.O. Contacts (2 KA2) | With 1 N.O. & 1 N.C. Contact (KA2, KA3) | Without Contacts |
|---|---------------|------------------------------|---|------------------|
| Momentary Dual Function | Universal (1) | KR6UH7 | KR6UH37 | KR6U |
| | Green-Red | KR6GRH7 | KR6GRH37 | KR6GR |
| | Other (2) | KR6■H7 | KR6■H37 | KR6■ |
| Momentary Interlocked Dual Function | Universal (1) | KR67UH7 | KR67UH37 | KR67U |
| | Green-Red | KR67GRH7 | KR67GRH37 | KR67GR |
| | Other (2) | KR67■H7 | KR67■H37 | KR67■ |
| Maintained Interlocked Dual Function | Universal (1) | KR7UH7 | KR7UH37 | KR7U |
| | Green-Red | KR7GRH7 | KR7GRH37 | KR7GR |
| | Other (2) | KR7■H7 | KR7■H37 | KR7■ |
| Description | Color | Contacts (KA1) | | Without Contacts |
| Both Buttons Maintained Interlocked Assembly | Universal (3) | — | | KR11U |
| | Other (4) | — | | KR11★ |
| One Button Momentary One Button Maintained Interlocked Assembly | Universal (3) | — | | KR12U |
| | Other (4) | — | | KR12★ |

(1) Universal for KR6, KR67, KR7 includes 2 inserts each of black, red and green.
 (2) Replace ■ with one color for each button. R = red, G = green, B = Black. Example: A KR6 with left button red and right button black = KR6RB
 (3) Universal for KR11, KR12 includes 2 each of black, red, green, yellow, orange, blue, white.
 (4) Replace ★ with one color for each button. B = black, R = red, G = green, L = blue, Y = yellow, W = white, S = orange, E = gray.
 Example: A KR11 with top button gray and bottom button orange = KR11ES



Emergency Break-Glass Operator 9001K15

Emergency Break-Glass Operator—UL 4, 13/NEMA 4, 13

Reference
K15

Operator is held in a depressed position by a glass disc. When the glass disc is broken with the hammer, button returns to a normal extended position. Package of 5 discs included with operator.

9001K15 Replacement Parts

| Description | Reference |
|--------------------------------|------------|
| Yellow bumper | 3105211101 |
| Hammer and chain | 3105206750 |
| Lower ring nut | 6512232801 |
| Top ring nut | 9001K40 |
| Package of 5 replacement discs | 9001K57 |
| Clip to hold hammer | 2540902240 |



Rocker Arm Operating Lever 9001K50

Rocker Arm Operating Lever

Reference
K50

Allows two standard push buttons to be operated independently of each other. Order push buttons and legend plates from pages 10, 11, 25, and 26 (please specify which marking is to be inverted).

Alternate Action—Push-on, Push-off Module

Reference
K85



Push-on Push-off Module 9001K85

This module can be added to standard 9001K, 9001KX, 9001SK or 9001T momentary push button operators. Contact blocks mounted behind this module (maximum of 2) are held in the depressed position when the operator is pressed once, and released to their normal position when the operator is pressed again. For a N.C. circuit, use a 9001KA3 or the N.C. contact of either a 9001KA1 or 9001KA4. For a N.O. circuit, use the N.O. contact of either a 9001KA4 or 9001KA6.



Wobble stick

For easy operation of any standard push button.

Reference
K8



Time Delay Push Button 9001KRD

Time Delay Push Button—UL Types 4, 13/NEMA 4, 13

| Description (Off - Delay) | Reference (All Colors) | | |
|---|------------------------|----------------|----------|
| | Full Guard | Extended Guard | No Guard |
|  Timed Contact 1 N.O. and 1 N.C. | KRD1UH1 | KRD2UH1 | KRD3UH1 |
|  Timed Contact 2 N.O. and 2 N.C. | KRD1UH2 | KRD2UH2 | KRD3UH2 |

Timing period is adjustable from 0.1 second to 60 seconds and begins after button has been released. Devices include a pack of seven color inserts for color coding the push button. See page 28 for Universal color insert. Contacts are quick make-quick break. Note: When mounted in top or bottom hole of a 9001K enclosure, device requires one additional space below or above operator. When mounted other than in top or bottom hole, device may require two additional spaces, one above and one below operator. Closing plates must be installed on unused holes.

Harmony™ 9001K/SK/KX

30 mm push buttons

9001K – Contact blocks

Note: When ordering, add prefix “9001” to the reference.

The 9001KA contact blocks are Fingersafe™ contact blocks (meeting VDE 0106 Part 100). They have one screw mounting and captive (backed out) plus/minus terminal screws. These contact blocks are double-break, direct-acting contacts. Because of the wiping action of these contacts, they are suitable for use with programmable controllers. All contact blocks listed below accept up to 2 #12–#24 AWG solid or stranded wires. Recommended tightening torque for screw terminals is 7 lb-in

Standard Contact Blocks

| Description | Symbol | Reference |
|---------------|----------------------------|------------|
| (Clear Cover) | Direct-Acting | KA1 |
| (Green Cover) | | KA2 |
| (Red Cover) | Direct-Acting | KA3 |
| (Clear Cover) | N.O. Contact Early Closing | KA4 |
| (Red Cover) | N.C. Contact Late Opening | KA5 |
| (Green Cover) | N.O. Contact Early Closing | KA6 |

Additional Circuit Arrangements

| | | |
|--|--|----------------------------------|
| Sequencing (1) N.O. Contact of KA4 closes before N.O. Contact on KA1 | | Order One9001KA4 and One 9001KA1 |
| Overlapping (1) N.O. Contact of KA4 closes before N.C. Contact of KA5 Opens | | Order One9001KA4 and One 9001KA5 |

(1) For push buttons or two-position selector switches only. For sequencing or overlapping contacts on other operators, refer to catalog 9001CT0001.

| Symbol | Contact Blocks with Binder Head Screws (not Fingersafe) Reference | Quantity (2) | Gold Flashed Contacts with Standard Pressure Wire Terminals Reference |
|---------------------------|---|--------------|---|
| | KA21 | 25–Up | KA31 |
| | KA22 | 25–Up | KA32 |
| | KA23 | 25–Up | KA33 |
| N.O. Early Closing | KA24 | 25–Up | KA34 |
| N.C. Contact Late Opening | KA25 | 25–Up | KA35 |

(2) Minimum order quantity is 25.

Contact blocks listed below are not Fingersafe, but provide:

- Terminals that accept ring tongue/fork tongue connectors
- Short single circuit contact blocks (0.75” deep vs. 0.97” deep on the Fingersafe)
- For assembled operators, use form Y238 (add to reference as suffix, for example: 9001KRU1H13Y238)

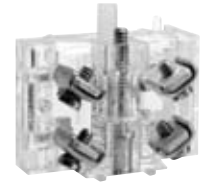

Contact blocks (not Fingersafe)

| Symbol | Reference | Symbol | Reference |
|--------|-------------|----------------------------|-------------|
| | KA1G | N.O. Contact Early Closing | KA4G |
| | KA2G | N.C. Contact Late Opening | KA5G |
| | KA3G | N.O. Contact Early Closing | KA6G |

Contact blocks with Quick-Connect terminals (not Fingersafe)

| Symbol | Reference |
|--------|-------------|
| | KA12 |
| | KA13 |

For dimensions, refer to catalog 9001CT0001

Maximum Current Ratings for Control Circuit Contacts—9001KA1–KA6, KA21–KA25, KA31–KA35, KA1G–KA6G

| V | AC | | | | | | V | DC | | | | |
|-----|--|------|---------|-----|-----------------------------|---|------|-------------------------------------|---------|-----|-----------------------------|---------|
| | Inductive (NEMA / UL Type A600) 35% Power Factor | | | | | Resistive 75% Power Factor Make, Break and Continuous Amperes | | Inductive and Resistive (NEMA Q600) | | | | |
| | Make | | Break | | Continuous Carrying Amperes | | | Make and Break | | | Continuous Carrying Amperes | |
| | Amperes | VA | Amperes | VA | | | | KA1 | KA2 KA3 | KA4 | | KA5 KA6 |
| 120 | 60 | 7200 | 6.0 | 720 | 10 | 10 | 125 | 0.55 | 0.55 | — | — | 2.5 |
| 240 | 30 | | 250 | | | | 0.27 | 0.27 | — | — | | |
| 480 | 15 | | 600 | | | | 0.10 | 0.10 | — | — | | |
| 600 | 12 | | | | | | | | | | | |

To select and order Contact Blocks, Light Modules, Knobs, and Accessories, see pages 50 to 59.

Harmony™ 9001K/SK/KX

30 mm push buttons

9001K – Contact blocks

Note: When ordering, add prefix “9001” to the reference.

Contact Block “H” Codes

The design of the 9001KA contact blocks allows them to be mounted side by side and/or in tandem. This enables you to specify an operator and a particular arrangement of contact blocks (shipped completely assembled) with a single reference number. See page 20 for a description of contact blocks.



Example: A 9001KR1B push button with 2 9001KA1 contact blocks would be 9001KR1BH2.

| Suffix No. (Add to Operator Reference) | Positions | | | | | |
|--|-----------|-----|-----|-----|-----|-----|
| | 1 | 2 | 3 | 4 | 5 | 6 |
| H1 | KA1 | | | | | |
| H2 | KA1 | KA1 | | | | |
| H3 | KA1 | KA1 | KA1 | | | |
| H4 | KA1 | KA1 | KA1 | KA1 | | |
| H5 | KA2 | | | | | |
| H6 | KA3 | | | | | |
| H7 | KA2 | KA2 | | | | |
| H8 | KA3 | KA3 | | | | |
| H9 | KA4 | KA1 | | | | |
| H10 | KA4 | KA5 | | | | |
| H11 | KA1 | KA1 | | KA1 | | |
| H12 | KA2 | KA3 | KA2 | KA3 | | |
| H13 | | KA1 | | | | |
| H14 | | KA3 | | | | |
| H15 | KA2 | KA3 | KA2 | | | |
| H16 | KA2 | KA3 | | KA3 | | |
| H17 | KA1 | KA1 | KA2 | | | |
| H18 | KA3 | KA1 | KA3 | | KA3 | |
| H19 | KA1 | KA1 | KA1 | KA1 | KA1 | |
| H21 | KA2 | KA3 | | | | |
| H23 | KA1 | KA1 | KA1 | KA1 | KA1 | KA1 |
| H24 | KA1 | KA2 | | | | |
| H25 | KA5 | KA3 | | | | |

Note: For “H” Codes not shown in this table, contact your local Schneider Electric representative.

Dimensions When Using Contact Blocks



Maximum Contact Block Usage:

- 2 blocks mounted side by side only:** Any 2, 3 or 4-Position spring return selector switch (non-illuminated, illuminated or keyed).
- 2 blocks mounted in tandem on one side only:** Any 2 operator interlocked push button.
- 2 blocks mounted in tandem (total of four blocks):** Any selector push button, keyed push button, 2, 3, or 4-Position maintained selector switch (non-illuminated, illuminated or keyed), push pull operators (non-illuminated or illuminated), joy stick, dual push button.
- 3 blocks mounted in tandem (total of six blocks):** Single momentary push buttons (non-illuminated or illuminated).

Harmony™ 9001K/SK/KX

30 mm push buttons

9001K – Contact blocks

Note: When ordering, add prefix “9001” to the reference.

Mounting Hole for All 9001K, -SK, and -KX Control Units



Hole Punch: Use Greenlee Tool #60242 to punch mounting hole and notch.

Maximum Contact Block Usage:

- **2 blocks mounted side by side only:** Any 2, 3 or 4-Position **spring return** selector switch (non-illuminated, illuminated or keyed).
- **2 blocks mounted in tandem on one side only:** Any 2 operator interlocked push button.
- **2 blocks mounted in tandem (total of four blocks):** Any selector push button, keyed push button, 2, 3, or 4-Position **maintained** selector switch (non-illuminated, illuminated or keyed), push-pull operators (non-illuminated or illuminated), joy stick, dual push button.
- **3 blocks mounted in tandem (total of six blocks):** Single momentary push buttons (non-illuminated or illuminated).



Min. Centerline Spacing, 9001K Control Units

| Legend Plate | Operator | Centerline Spacing (in) | | | | | |
|---|------------------------|-------------------------|------|------|------|------|------|
| | | A | B | C | D | E | F |
| Legend Plate Orientation Position #1 | | | | | | | |
| KN2 | Standard Push Button | 1.75 | 1.31 | 1.44 | 2.25 | 1.69 | 0.88 |
| | 1.375 in Dia. Mushroom | 1.75 | 1.31 | 1.44 | 2.25 | 1.69 | 0.88 |
| | 2.25 in Dia. Mushroom | 2.25 | 1.31 | 1.44 | 2.25 | 2.25 | 1.12 |
| | Selector Switch Knobs | 1.75 | 1.31 | 1.44 | 2.25 | 1.69 | 0.88 |
| KN3 | Standard Push Button | 2.00 | 1.31 | 1.44 | 2.25 | 1.75 | 0.88 |
| | 1.375 in Dia. Mushroom | 2.00 | 1.31 | 1.44 | 2.25 | 1.75 | 0.88 |
| | 2.25 in Dia. Mushroom | 2.25 | 1.31 | 1.44 | 2.25 | 2.25 | 1.12 |
| | Selector Switch Knobs | 2.00 | 1.31 | 1.44 | 2.25 | 1.75 | 0.88 |
| KN4 | Standard Push Button | 1.94 | 1.31 | 1.44 | 2.25 | 1.62 | 0.88 |
| | 1.375 in Dia. Mushroom | 1.94 | 1.31 | 1.44 | 2.25 | 1.62 | 0.88 |
| | 2.25 in Dia. Mushroom | 2.25 | 1.31 | 1.44 | 2.25 | 2.25 | 1.12 |
| | Selector Switch Knobs | 1.74 | 1.31 | 1.44 | 2.25 | 1.62 | 0.88 |
| KN6 | Standard Push Button | 2.38 | 1.62 | 1.44 | 2.25 | 2.25 | 1.12 |
| | 1.375 in Dia. Mushroom | 2.38 | 1.62 | 1.44 | 2.25 | 2.25 | 1.12 |
| | 2.25 in Dia. Mushroom | 2.38 | 1.62 | 1.44 | 2.25 | 2.25 | 1.12 |
| | Selector Switch Knobs | 2.38 | 1.62 | 1.44 | 2.25 | 2.25 | 1.12 |

| Legend Plate | Operator | Centerline Spacing (in) | | | | | |
|---|------------------------|-------------------------|------|------|------|------|------|
| | | A | B | C | D | E | F |
| Legend Plate Orientation Position #2 | | | | | | | |
| KN2 | Standard Push Button | 1.62 | 1.31 | 1.44 | 2.25 | 1.75 | 0.88 |
| | 1.375 in Dia. Mushroom | 1.62 | 1.31 | 1.44 | 2.25 | 1.75 | 0.88 |
| | 2.25 in Dia. Mushroom | 2.25 | 1.31 | 1.44 | 2.25 | 2.25 | 1.12 |
| | Selector Switch Knobs | 1.62 | 1.31 | 1.44 | 2.25 | 1.75 | 0.88 |
| KN3 | Standard Push Button | 1.75 | 1.31 | 1.44 | 2.25 | 2.00 | 0.88 |
| | 1.375 in Dia. Mushroom | 1.75 | 1.31 | 1.44 | 2.25 | 2.00 | 0.88 |
| | 2.25 in Dia. Mushroom | 2.25 | 1.31 | 1.44 | 2.25 | 2.25 | 1.12 |
| | Selector Switch Knobs | 1.75 | 1.31 | 1.44 | 2.25 | 2.00 | 0.88 |
| KN4 | Standard Push Button | 1.62 | 1.31 | 1.44 | 2.25 | 1.94 | 1.00 |
| | 1.375 in Dia. Mushroom | 1.62 | 1.31 | 1.44 | 2.25 | 1.94 | 1.00 |
| | 2.25 in Dia. Mushroom | 2.25 | 1.31 | 1.44 | 2.25 | 2.25 | 1.12 |
| | Selector Switch Knobs | 1.62 | 1.31 | 1.44 | 2.25 | 1.94 | 1.00 |
| KN6 | Standard Push Button | 2.25 | 1.31 | 1.62 | 2.38 | 2.38 | 0.88 |
| | 1.375 in Dia. Mushroom | 2.25 | 1.31 | 1.62 | 2.38 | 2.38 | 0.88 |
| | 2.25 in Dia. Mushroom | 2.25 | 1.31 | 1.62 | 2.38 | 2.38 | 1.12 |
| | Selector Switch Knobs | 2.25 | 1.31 | 1.62 | 2.38 | 2.38 | 0.88 |

Harmony™ 9001K/SK/KX

30 mm push buttons

9001K – Contact blocks

Note: When ordering, add prefix “9001” to the reference.

Hazardous locations do not always require the use of explosion-proof equipment like the 9001BR control stations. Selecting the most appropriate device for the location can save you money. For more information on the types of hazardous locations, contact your local electrical inspector.

Schneider Electric Offering According to Class, Division, and Group

| For Class | Division | Group(s) | Use |
|-----------|----------|----------|--|
| I | 1 | A | 1. Intrinsically Safe System |
| I | 1 | B, C, D | 1. 9001BR station 2. Intrinsically Safe System |
| I | 2 | A | 1. 9001K control stations with restrictions (1) 2. Intrinsically Safe System |
| I | 2 | B, C, D | 1. 9001BR station 2. 9001K control stations with restrictions (1) 3. Intrinsically Safe System |
| II | 1 | E, F, G | 1. 9001BR station 2. Intrinsically Safe System |
| II | 2 | E, F | 1. 9001BR station 2. 9001K control stations with restrictions (1) 3. Intrinsically Safe System |
| II | 2 | G | 1. 9001BR station 2. 9001K control stations with restrictions (2) 3. Intrinsically Safe System |
| III | 1, 2 | — | 1. 9001BR Station 2. 9001K control stations with restrictions (2) 3. Intrinsically Safe System |

Any 9001K operator can be used in an area classified as Class I, Division 2 hazardous locations, if:

- Only logic (KA40 series) or power (KA50 series) reed contact blocks are used.
- All 9001K illuminated operators are UL approved for use in Class I Division 2 areas.
- The operators are mounted in any NEMA 4 & 13 enclosures.

(1) Any 9001K operator mounted in a 9001KY, 9001KYSS, 9001KYAF or 9001SKY enclosure may be used, except potentiometer operators.

(2) Add Form Y243 to single lamp Push-To-Test pilot lights.

Note: For (1) and (2): UL Listed: File E10054(N), CCN NOIV.

Hazardous Locations:



File E10054(N)
CCN NOIV



File LR26817
Class 3218 02

Hermetically Sealed Logic Reed Contact Blocks Suitable for use on low energy level circuits

| Description | Symbol | Reference |
|-------------|--------|-----------|
| | | KA41 |
| | | KA42 |
| | | KA43 |
| | | KA44 |
| | | KA45 |

| Max. Vac/Vdc | Maximum Load | | |
|--------------|--------------|-----------|------------|
| | Resistive | Inductive | Continuous |
| 32/30 | .25 A | .10 A | .5 A |
| 120/100 | 8 VA | 3 VA | .5 A |

The maximum number of logic and/or power reed contact blocks per operator is as indicated on individual selection tables for standard contact blocks, **except**:

- On 3-Position selector switches with cams C, D, E, F, G, L, or M, mount reed blocks on **one side only** (either side), maximum 2 in tandem.
- On 4-Position selector switches, mount reed blocks on **one side only** (either side), maximum 2 in tandem.
- On joysticks or on 9001KR8 push-pull operators, mount reed blocks on **one side only** (either side), maximum 2 in tandem.

Hermetically Sealed Power Reed Contact Blocks (5)

| Description | Symbol | Reference |
|-------------|--------|-----------|
| | | KA51 |
| | | KA52 |
| | | KA53 |
| | | KA54 |
| | | KA55 |

| Volts | AC NEMA C300 (3) | | | | Continuous Carrying Amperes |
|-------|------------------|------|-------|-----|-----------------------------|
| | Make | | Break | | |
| | A | VA | A | VA | |
| 120 | 10.00 | 1200 | 1.000 | 120 | 3.0 |
| 240 | 5.00 | | .500 | | |

| Volts | DC NEMA Q150 (4) | | | | Continuous Carrying Amperes |
|-------|------------------|----|-------|----|-----------------------------|
| | Make | | Break | | |
| | A | VA | A | VA | |
| 115 | .50 | 58 | .50 | 58 | 3.0 |

Note: All contact blocks listed above except #12–18 solid or stranded wire.

The power reed contact blocks can be used with standard industrial relays and starters through NEMA Size 4. Minimum voltage is 5 V and the minimum current is 1 mA.

(3) Inductive Rating—35% Power Factor.

(4) Inductive and Resistive Ratings

(5) Not for use in pendant stations.

Harmony™ 9001K/SK/KX

30 mm push buttons

9001K – Light modules

Note: When ordering, add prefix “9001” to the reference.



| Standard Light Modules for 9001K Control Units (1) | | | | | |
|--|--|------------------------|-----------------------|--------|----------------------------|
| Voltage | Description | Light Module Reference | Voltage Assembly Code | Rating | Replacement Lamp Reference |
| All | Full Voltage (without Bayonet Base Lamp) | KM40 | 40 | — | no lamp included |
| 6 Vac/Vdc | Full Voltage | KM31 | 31 | .9 VA | 2550101020 |
| 6 Vac/Vdc | LED Red | KM31LR | 31LR | | 6508805201 |
| 6 Vac/Vdc | LED Green | KM31LG | 31LG | | 6508805203 |
| 6 Vac/Vdc | LED Yellow | KM31LY | 31LY | | 6508805202 |
| 12–14 Vac/Vdc | Full Voltage | KM32 | 32 | 1.2 VA | 2550101037 |
| 12–14 Vac/Vdc | LED Red | KM32LR | 32LR | | 6508805201 |
| 12–14 Vac/Vdc | LED Green | KM32LG | 32LG | | 6508805203 |
| 12–14 Vac/Vdc | LED Yellow | KM32LY | 32LY | | 6508805202 |
| 18 Vac/Vdc | Resistor | KM33 | 33 | 1.4 VA | 2550101037 |
| 24–28 Vac/Vdc | Full Voltage | KM35 | 35 | 1.2 VA | 2550101002 |
| 24–28 Vac/Vdc | LED Red | KM35LR | 35LR | .28 VA | 6508805210 |
| 24–28 Vac/Vdc | LED Green | KM35LG | 35LG | .28 VA | 6508805212 |
| 24–28 Vac/Vdc | LED Yellow | KM35LY | 35LY | .28 VA | 6508805211 |
| 24–28 Vac/Vdc | LED White | KM35LW | 35LW | .28 VA | 6508805214 |
| 24–28 Vac/Vdc | LED Blue | KM35LL | 35LL | .28 VA | 6508805213 |
| 48 Vac/Vdc | Full Voltage | KM36 | 36 | 2.6 VA | 2550101025 |
| 110–120 V, 50–60 Hz | LED Red | KM1LR | 1LR | | 6508805201 |
| 110–120 V, 50–60 Hz | LED Green | KM1LG | 1LG | | 6508805203 |
| 110–120 V, 50–60 Hz | LED Yellow | KM1LY | 1LY | | 6508805202 |
| 110–120 V, 50–60 Hz | Transformer | KM1 | 1 | 2.4 VA | 2550101020 |
| 110–120 V, 50–60 Hz | Flashing | KMF1 | F1 | .85 VA | 2550101036 |
| 120 Vac/Vdc | Resistor | KM38 | 38 | 3.0 VA | 2550101027 |
| 120 Vac/Vdc | Full Voltage | KM38 | 38 | 3.0 VA | 2550101027 |
| 120 Vac/Vdc | Neon | KM11 | 11 | 0.2 VA | 2550101013 |
| 120 Vac/Vdc | LED Red | KM38LR | 38LR | 1.4 VA | 6508805210 |
| 120 Vac/Vdc | LED Green | KM38LG | 38LG | 1.4 VA | 6508805212 |
| 120 Vac/Vdc | LED Yellow | KM38LY | 38LY | 1.4 VA | 6508805211 |
| 120 Vac/Vdc | LED White | KM38LW | 38LW | 1.4 VA | 6508805214 |
| 120 Vac/Vdc | LED Blue | KM38LL | 38LL | 1.4 VA | 6508805213 |
| 208–220 V, 50–60 Hz | Transformer | KM3 | 3 | 2.5 VA | 2550101020 |
| 208–220 V, 50–60 Hz | LED Red | KM3LR | 3LR | | 6508805201 |
| 208–220 V, 50–60 Hz | LED Green | KM3LG | 3LG | | 6508805203 |
| 208–220 V, 50–60 Hz | LED Yellow | KM3LY | 3LY | | 6508805202 |
| 208–220 V, 50–60 Hz | LED White | KM3LW | 3LW | | 6508805215 |
| 208–220 V, 50–60 Hz | LED Blue | KM3LL | 3LL | | 6508805216 |
| 220–240 V, 50–60 Hz | Transformer | KM7 | 7 | 2.0 VA | 2550101020 |
| 220–240 V, 50–60 Hz | LED Red | KM7LR | 7LR | | 6508805201 |
| 220–240 V, 50–60 Hz | LED Green | KM7LG | 7LG | | 6508805203 |
| 220–240 V, 50–60 Hz | LED Yellow | KM7LY | 7LY | | 6508805202 |
| 220–240 V, 50–60 Hz | LED White | KM7LW | 7LW | | 6508805215 |
| 220–240 V, 50–60 Hz | LED Blue | KM7LL | 7LL | | 6508805216 |
| 240 Vac/Vdc | Resistor | KM25 | 25 | 6.0 VA | 2550101027 |
| 240 Vac/Vdc | Neon | KM12 | 12 | 0.3 VA | 2550101013 |
| 277 V, 50–60 Hz | Transformer | KM8 | 8 | 2.4 VA | 2550101020 |
| 380–480 V, 50–60 Hz | Transformer | KM5 | 5 | 2.8 VA | 2550101020 |
| 480 Vac/Vdc | Neon | KM14 | 14 | 0.5 VA | 2550101013 |
| 550–600 V, 50–60 Hz | Transformer | KM6 | 6 | 2.5 VA | 2550101020 |

(1) For use with all operators except KX and remote test pilot.

Notes: Light modules are available in other voltages, as shown above. For use in hazardous locations, see page 23. With neon type light modules, use a clear color cap only. With LED light modules, use either a clear color cap or a cap the same color as the LED.



| Shallow Depth Light Modules for 9001K Control Units (2) | | | | | |
|---|--------------|------------------------|-----------------------|--------|----------------------------|
| Voltage | Description | Light Module Reference | Voltage Assembly Code | Rating | Replacement Lamp Reference |
| 24–28 Vac/Vdc | Full Voltage | KM55 | 55 | 1.2 VA | 2550101002 |
| | LED Red | KM55LR | 55LR | 0.5 VA | 6508805204 |
| | LED Green | KM55LG | 55LG | | 6508805206 |
| | LED Yellow | KM55LY | 55LY | | 6508805205 |
| 110–120 Vac/Vdc | Full Voltage | KM58 | 58 | 3.0 VA | 2550101027 |
| | LED Red | KM58LR | 58LR | 0.5 VA | 6508805204 |
| | LED Green | KM58LG | 58LG | | 6508805206 |
| | LED Yellow | KM58LY | 58LY | | 6508805205 |

(2) For use with all operators except KX and remote test pilot.

Notes: For use in hazardous locations, see page 23. Reduces the depth of illuminated push buttons with contact blocks by over 33%. With LED light modules, use a cap that is the same color as the LED.



File
CCN

E42259
NKCR



File
Class LR25490
3211 03





marked

Harmony™ 9001K/SK/KX

30 mm push buttons

9001K – Legend plates

Note: When ordering, add prefix “9001” to the reference.

| Legend Plates | | | | | | | | | | | | |
|--|--|-------------------------------|-------------------------------|--------------------------------|-------------------------------|-------------------------------|--------------------------------|-------------------------------|-------------------------------|---|---|---|
| Standard Markings | Plastic Legend Plates for use with 9001K Operators | | | | | | | | | Aluminum Legend Plates for use with 9001K Operators | | |
| | 1-3/4" Square | | | 2-1/4" Square | | | 2-1/2" Square | | | Black Legend | Black Legend | Blue Legend |
| | Silver Legend w/ Black Letters | White Legend w/ Black Letters | Black Legend w/ White Letters | Silver Legend w/ Black Letters | White Legend w/ Black Letters | Black Legend w/ White Letters | Silver Legend w/ Black Letters | White Legend w/ Black Letters | Black Legend w/ White Letters |  |  |  |
| For Push Button or Pilot Light | | | | | | | | | | | | |
| Blank | KN200SP | KN200WP | KN200BP | KN100SP | KN100WP | KN100BP | KN700SP | KN700WP | KN700BP | KN200 | KN300 | KN800 |
| Blank (red) | KN200RP (2) | KN200RP (2) | KN200RP (2) | KN100RP (2) | KN100RP (2) | KN100RP (2) | KN700RP (2) | KN700RP (2) | KN700RP (2) | KN200R (1) | KN300R (1) | KN800R (1) |
| Start | KN201SP | KN201WP | KN201BP | KN101SP | KN101WP | KN101BP | KN701SP | KN701WP | KN701BP | KN201 | KN301 | KN801 |
| Stop | KN202RP (2) | KN202RP (2) | KN202RP (2) | KN102RP (2) | KN102RP (2) | KN102RP (2) | KN702RP (2) | KN702RP (2) | KN702RP (2) | KN202 (1) | KN302 (1) | KN802 (1) |
| On | KN203SP | KN203WP | KN203BP | KN103SP | KN103WP | KN103BP | KN703SP | KN703WP | KN703BP | KN203 | KN303 | KN803 |
| Off | KN204RP (2) | KN204RP (2) | KN204RP (2) | KN104RP (2) | KN104RP (2) | KN104RP (2) | KN704RP (2) | KN704RP (2) | KN704RP (2) | KN204 (1) | KN304 (1) | KN804 (1) |
| Emerg. Stop | KN205RP (2) | KN205RP (2) | KN205RP (2) | KN105RP (2) | KN105RP (2) | KN105RP (2) | KN705RP (2) | KN705RP (2) | KN705RP (2) | KN205 (1) | KN305 (1) | KN805 (1) |
| Forward | KN206SP | KN206WP | KN206BP | KN106SP | KN106WP | KN106BP | KN706SP | KN706WP | KN706BP | KN206 | KN306 | KN806 |
| Reverse | KN207SP | KN207WP | KN207BP | KN107SP | KN107WP | KN107BP | KN707SP | KN707WP | KN707BP | KN207 | KN307 | KN807 |
| Close | KN208SP | KN208WP | KN208BP | KN108SP | KN108WP | KN108BP | KN708SP | KN708WP | KN708BP | KN208 | KN308 | KN808 |
| Open | KN209SP | KN209WP | KN209BP | KN109SP | KN109WP | KN109BP | KN709SP | KN709WP | KN709BP | KN209 | KN309 | KN809 |
| Down | KN210SP | KN210WP | KN210BP | KN110SP | KN110WP | KN110BP | KN710SP | KN710WP | KN710BP | KN210 | KN310 | KN810 |
| Up | KN211SP | KN211WP | KN211BP | KN111SP | KN111WP | KN111BP | KN711SP | KN711WP | KN711BP | KN211 | KN311 | KN811 |
| Fast | KN212SP | KN212WP | KN212BP | KN112SP | KN112WP | KN112BP | KN712SP | KN712WP | KN712BP | KN212 | KN312 | KN812 |
| Slow | KN213SP | KN213WP | KN213BP | KN113SP | KN113WP | KN113BP | KN713SP | KN713WP | KN713BP | KN213 | KN313 | KN813 |
| High | KN214SP | KN214WP | KN214BP | KN114SP | KN114WP | KN114BP | KN714SP | KN714WP | KN714BP | KN214 | KN314 | KN814 |
| Low | KN215SP | KN215WP | KN215BP | KN115SP | KN115WP | KN115BP | KN715SP | KN715WP | KN715BP | KN215 | KN315 | KN815 |
| Inch | KN216SP | KN216WP | KN216BP | KN116SP | KN116WP | KN116BP | KN716SP | KN716WP | KN716BP | KN216 | KN316 | KN816 |
| In | KN217SP | KN217WP | KN217BP | KN117SP | KN117WP | KN117BP | KN717SP | KN717WP | KN717BP | KN217 | KN317 | KN817 |
| Jog | KN218SP | KN218WP | KN218BP | KN118SP | KN118WP | KN118BP | KN718SP | KN718WP | KN718BP | KN218 | KN318 | KN818 |
| Jog For. | KN219SP | KN219WP | KN219BP | KN119SP | KN119WP | KN119BP | KN719SP | KN719WP | KN719BP | KN219 | KN319 | KN819 |
| Jog Rev. | KN220SP | KN220WP | KN220BP | KN120SP | KN120WP | KN120BP | KN720SP | KN720WP | KN720BP | KN220 | KN320 | KN820 |
| Lower | KN221SP | KN221WP | KN221BP | KN121SP | KN121WP | KN121BP | KN721SP | KN721WP | KN721BP | KN221 | KN321 | KN821 |
| Out | KN222SP | KN222WP | KN222BP | KN122SP | KN122WP | KN122BP | KN722SP | KN722WP | KN722BP | KN222 | KN322 | KN822 |
| Reset | KN223SP | KN223WP | KN223BP | KN123SP | KN123WP | KN123BP | KN723SP | KN723WP | KN723BP | KN223 | KN323 | KN823 |
| Run | KN224SP | KN224WP | KN224BP | KN124SP | KN124WP | KN124BP | KN724SP | KN724WP | KN724BP | KN224 | KN324 | KN824 |
| Start Jog | KN225SP | KN225WP | KN225BP | KN125SP | KN125WP | KN125BP | KN725SP | KN725WP | KN725BP | KN225 | KN325 | KN825 |
| Test | KN226SP | KN226WP | KN226BP | KN126SP | KN126WP | KN126BP | KN726SP | KN726WP | KN726BP | KN226 | KN326 | KN826 |
| Raise | KN227SP | KN227WP | KN227BP | KN127SP | KN127WP | KN127BP | KN727SP | KN727WP | KN727BP | KN227 | KN327 | KN827 |
| Decrease | KN228SP | KN228WP | KN228BP | KN128SP | KN128WP | KN128BP | KN728SP | KN728WP | KN728BP | KN228 | KN328 | KN828 |
| Increase | KN229SP | KN229WP | KN229BP | KN129SP | KN129WP | KN129BP | KN729SP | KN729WP | KN729BP | KN229 | KN329 | KN829 |
| Left | KN230SP | KN230WP | KN230BP | KN130SP | KN130WP | KN130BP | KN730SP | KN730WP | KN730BP | KN230 | KN330 | KN830 |
| Right | KN231SP | KN231WP | KN231BP | KN131SP | KN131WP | KN131BP | KN731SP | KN731WP | KN731BP | KN231 | KN331 | KN831 |
| Cycle Start | KN232SP | KN232WP | KN232BP | KN132SP | KN132WP | KN132BP | KN732SP | KN732WP | KN732BP | KN232 | KN332 | KN832 |
| Feed Start | KN233SP | KN233WP | KN233BP | KN133SP | KN133WP | KN133BP | KN733SP | KN733WP | KN733BP | KN233 | KN333 | KN833 |
| Cycle Stop | KN234SP | KN234WP | KN234BP | KN134SP | KN134WP | KN134BP | KN734SP | KN734WP | KN734BP | KN234 | KN334 | KN834 |
| Motor Run | KN236SP | KN236WP | KN236BP | KN136SP | KN136WP | KN136BP | KN736SP | KN736WP | KN736BP | KN236 | KN336 | KN836 |
| Motor Stop | KN237SP | KN237WP | KN237BP | KN137SP | KN137WP | KN137BP | KN737SP | KN737WP | KN737BP | KN237 | KN337 | KN837 |
| Power On | KN238SP | KN238WP | KN238BP | KN138SP | KN138WP | KN138BP | KN738SP | KN738WP | KN738BP | KN238 | KN338 | KN838 |
| Pull To Start | N/A | N/A | N/A | KN179SP | KN179WP | KN179BP | KN779SP | KN779WP | KN779BP | N/A | KN379 | N/A |
| Push To Stop | | | | | | | | | | | | |
| For Selector Switch or Selector Push Button | | | | | | | | | | | | |
| For.-Rev. | KN239SP | KN239WP | KN239BP | KN139SP | KN139WP | KN139BP | KN739SP | KN739WP | KN739BP | KN239 | KN339 | KN839 |
| Hand-Auto. | KN240SP | KN240WP | KN240BP | KN140SP | KN140WP | KN140BP | KN740SP | KN740WP | KN740BP | KN240 | KN340 | KN840 |
| High-Low | KN241SP | KN241WP | KN241BP | KN141SP | KN141WP | KN141BP | KN741SP | KN741WP | KN741BP | KN241 | KN341 | KN841 |
| Jog-Run | KN242SP | KN242WP | KN242BP | KN142SP | KN142WP | KN142BP | KN742SP | KN742WP | KN742BP | KN242 | KN342 | KN842 |
| Man.-Auto. | KN243SP | KN243WP | KN243BP | KN143SP | KN143WP | KN143BP | KN743SP | KN743WP | KN743BP | KN243 | KN343 | KN843 |
| Off-On | KN244SP | KN244WP | KN244BP | KN144SP | KN144WP | KN144BP | KN744SP | KN744WP | KN744BP | KN244 | KN344 | KN844 |
| On-Off | KN245SP | KN245WP | KN245BP | KN145SP | KN145WP | KN145BP | KN745SP | KN745WP | KN745BP | KN245 | KN345 | KN845 |
| Open-Close | KN246SP | KN246WP | KN246BP | KN146SP | KN146WP | KN146BP | KN746SP | KN746WP | KN746BP | KN246 | KN346 | KN846 |
| Raise-Lower | KN247SP | KN247WP | KN247BP | KN147SP | KN147WP | KN147BP | KN747SP | KN747WP | KN747BP | KN247 | KN347 | KN847 |
| Run-Jog | KN248SP | KN248WP | KN248BP | KN148SP | KN148WP | KN148BP | KN748SP | KN748WP | KN748BP | KN248 | KN348 | KN848 |
| Slow-Fast | KN250SP | KN250WP | KN250BP | KN150SP | KN150WP | KN150BP | KN750SP | KN750WP | KN750BP | KN250 | KN350 | KN850 |
| Start-Stop | KN251SP | KN251WP | KN251BP | KN151SP | KN151WP | KN151BP | KN751SP | KN751WP | KN751BP | KN251 | KN351 | KN851 |
| Up-Down | KN253SP | KN253WP | KN253BP | KN153SP | KN153WP | KN153BP | KN753SP | KN753WP | KN753BP | KN253 | KN353 | KN853 |
| Low-High | KN254SP | KN254WP | KN254BP | KN154SP | KN154WP | KN154BP | KN754SP | KN754WP | KN754BP | KN254 | KN354 | KN854 |
| Stop-Start | KN255SP | KN255WP | KN255BP | KN155SP | KN155WP | KN155BP | KN755SP | KN755WP | KN755BP | KN255 | KN355 | KN855 |
| Left-Right | KN256SP | KN256WP | KN256BP | KN156SP | KN156WP | KN156BP | KN756SP | KN756WP | KN756BP | KN256 | KN356 | KN856 |
| On-Auto | KN276SP | KN276WP | KN276BP | KN176SP | KN176WP | KN176BP | KN776SP | KN776WP | KN776BP | KN276 | KN376 | KN876 |
| Auto-Off-Hand | KN258SP | KN258WP | KN258BP | KN158SP | KN158WP | KN158BP | KN758SP | KN758WP | KN758BP | KN258 | KN358 | KN858 |
| For.-Off-Rev. | KN259SP | KN259WP | KN259BP | KN159SP | KN159WP | KN159BP | KN759SP | KN759WP | KN759BP | KN259 | KN359 | KN859 |
| Hand-Off-Auto. | KN260SP | KN260WP | KN260BP | KN160SP | KN160WP | KN160BP | KN760SP | KN760WP | KN760BP | KN260 | KN360 | KN860 |
| Man.-Off-Auto. | KN262SP | KN262WP | KN262BP | KN162SP | KN162WP | KN162BP | KN762SP | KN762WP | KN762BP | KN262 | KN362 | KN862 |
| Open-Off-Close | KN263SP | KN263WP | KN263BP | KN163SP | KN163WP | KN163BP | KN763SP | KN763WP | KN763BP | KN263 | KN363 | KN863 |
| Up-Off-Down | KN264SP | KN264WP | KN264BP | KN164SP | KN164WP | KN164BP | KN764SP | KN764WP | KN764BP | KN264 | KN364 | KN864 |
| Low-Off-High | KN265SP | KN265WP | KN265BP | KN165SP | KN165WP | KN165BP | KN765SP | KN765WP | KN765BP | KN265 | KN365 | KN865 |
| Jog-Stop-Run | KN267SP | KN267WP | KN267BP | KN167SP | KN167WP | KN167BP | KN767SP | KN767WP | KN767BP | KN267 | KN367 | KN867 |
| High-Low-Off | KN270SP | KN270WP | KN270BP | KN170SP | KN170WP | KN170BP | KN770SP | KN770WP | KN770BP | KN270 | KN370 | KN870 |
| High-Off-Low | KN277SP | KN277WP | KN277BP | KN177SP | KN177WP | KN177BP | KN777SP | KN777WP | KN777BP | KN277 | KN377 | KN877 |
| Auto-Man.-Off | KN278SP | KN278WP | KN278BP | KN178SP | KN178WP | KN178BP | KN778SP | KN778WP | KN778BP | KN278 | KN378 | KN878 |

(1) Legend plate has red background with silver letters.
 (2) Legend plate has red background with black letters.

Harmony™ 9001K/SK/KX

30 mm push buttons

9001K – Legend plates

Note: When ordering, add prefix “9001” to the reference.

| Legend Plates—Special Marking | | | |
|---|----------------------------|-----------------------------|---------------------|
| Legend Plate | Description | | Reference |
| KN100●P (Plastic) (1) 2.25 in Square | Standard Markings | | See page 25 |
| | Special Marking | Silver Field, Black Letters | KN199SP |
| | | White Field, Black Letters | KN199WP |
| | | Red Field, Black Letters | KN199RP |
| | Black Field, White Letters | KN199BP | |
| KN200 Aluminum | Standard Markings | | See page 25 |
| | Special Marking | Black Field | KN299 |
| (2) | | Red Field | KN299R |
| KN200●P (Plastic) (1) 1.7 in Square | Standard Markings | | See page 25 |
| | Special Marking | Silver Field, Black Letters | KN299SP |
| | | White Field, Black Letters | KN299WP |
| | | Red Field, Black Letters | KN299RP |
| | Black Field, White Letters | KN299BP | |
| KN300 Aluminum | Standard Markings | | See page 25 |
| | Special Marking | Black Field | KN399 |
| (2) | | Red Field | KN399R |
| KN400 Aluminum | Blank | | KN400 |
| | Any Marking (2) | | KN499 |
| KN500 Aluminum | Standard Markings | | Select from page 25 |
| | Special Marking | Black Field | KN599 |
| (2) | | Green Red Field | KN519 |
| KN600 Aluminum | Blank | Black Field | KN600 |
| | | Red Field | KN600R |
| | Any Marking | Black Field | KN699 |
| (2) | | Red Field | KN699R |
| KN700●P (Plastic) (1) 2.5 in Square | Standard Markings | | Select from page 25 |
| | Special Marking | Silver Field, Black Letters | KN799SP |
| | | White Field, Black Letters | KN799WP |
| | | Red Field, Black Letters | KN799RP |
| | Black Field, White Letters | KN799BP | |
| KN800 Aluminum | Standard Markings | | Select from page 25 |
| | Special Marking | Blue Field | KN899 |
| (2) | | Red Field | KN899R |
| KN900 Aluminum | Blank | | KN900 |
| | Any Marking (2) | | KN999 |

(1) Other colors available (see table below).
(2) Specify marking required.

| Plastic Legend Plates—Other Colors | | | | | |
|------------------------------------|--------------|--------------|---------------|----------------|---------------|
| | Plate Color | Letter Color | 1.7 in Square | 2.25 in Square | 2.5 in Square |
| Blank Legend Plates | Yellow | Black | KN200YP | KN100YP | KN700YP |
| | Green | White | KN200GP | KN100GP | KN700GP |
| | Blue | | KN200LP | KN100LP | KN700LP |
| | Red | | KN200CP | KN100CP | KN700CP |
| | Orange | | KN200AP | KN100AP | KN700AP |
| Special Engraved Legend Plates | Burnt Orange | Black | KN200HP | KN100HP | KN700HP |
| | Yellow | Black | KN299YP | KN199YP | KN799YP |
| | Green | White | KN299GP | KN199GP | KN799GP |
| | Blue | | KN299LP | KN199LP | KN799LP |
| | Red | | KN299CP | KN199CP | KN799CP |
| | Orange | | KN299AP | KN199AP | KN799AP |
| | Burnt Orange | Black | KN299HP | KN199HP | KN799HP |

| Maximum Number of Lines and Characters for 9001KN Legend Plates | | | | | | | | | |
|---|-------|-------|-------|-------|-----------|-------|-------|-------|----------|
| Reference | KN100 | KN200 | KN300 | KN400 | KN500 | KN600 | KN700 | KN800 | KN900 |
| Max. No. of Char. per Line | 16 | 14 | 18 | 18 | 8 | 22 | 17 | 18 | 18 |
| | | | | | per field | | | | per pos. |
| Max. No. of Lines | 2 | 1 | 3 | 2 | 2 | 4 | 2 | 2 | 1 |
| | | | | | per field | | | | per pos. |

Note: The maximum number of characters and lines is a practical maximum, based on a minimum size of characters to facilitate easy reading.

| Circular Legends for Emergency Stop Mushroom Heads (yellow background) | | |
|--|----------------|-----------|
| Diameter | Text | Reference |
| 60 mm | — | KN9100 |
| | EMERGENCY STOP | KN9330 |
| 90 mm | — | KN8100 |
| | EMERGENCY STOP | KN8330 |



Legend Plate Position #1

| Min. Centerline Spacing, 9001K Control Units | | | | | | | |
|--|------------------------|-------------------------|------|------|------|------|------|
| Legend Plate | Operator | Centerline Spacing (in) | | | | | |
| | | A | B | C | D | E | F |
| Legend Plate Orientation Position #1 | | | | | | | |
| KN2 | Standard Push Button | 1.75 | 1.31 | 1.44 | 2.25 | 1.69 | 0.88 |
| KN5 | 1.375 in Dia. Mushroom | 1.75 | 1.31 | 1.44 | 2.25 | 1.69 | 0.88 |
| | 2.25 in Dia. Mushroom | 2.25 | 1.31 | 1.44 | 2.25 | 2.25 | 1.12 |
| | Selector Switch Knobs | 1.75 | 1.31 | 1.44 | 2.25 | 1.69 | 0.88 |
| KN3 | Standard Push Button | 2.00 | 1.31 | 1.44 | 2.25 | 1.75 | 0.88 |
| | 1.375 in Dia. Mushroom | 2.00 | 1.31 | 1.44 | 2.25 | 1.75 | 0.88 |
| | 2.25 in Dia. Mushroom | 2.25 | 1.31 | 1.44 | 2.25 | 2.25 | 1.12 |
| | Selector Switch Knobs | 2.00 | 1.31 | 1.44 | 2.25 | 1.75 | 0.88 |
| KN4 | Standard Push Button | 1.94 | 1.31 | 1.44 | 2.25 | 1.62 | 0.88 |
| | 1.375 in Dia. Mushroom | 1.94 | 1.31 | 1.44 | 2.25 | 1.62 | 0.88 |
| | 2.25 in Dia. Mushroom | 2.25 | 1.31 | 1.44 | 2.25 | 2.25 | 1.12 |
| | Selector Switch Knobs | 1.74 | 1.31 | 1.44 | 2.25 | 1.62 | 0.88 |
| KN6 | Standard Push Button | 2.38 | 1.62 | 1.44 | 2.25 | 2.25 | 1.12 |
| | 1.375 in Dia. Mushroom | 2.38 | 1.62 | 1.44 | 2.25 | 2.25 | 1.12 |
| | 2.25 in Dia. Mushroom | 2.38 | 1.62 | 1.44 | 2.25 | 2.25 | 1.12 |
| | Selector Switch Knobs | 2.38 | 1.62 | 1.44 | 2.25 | 2.25 | 1.12 |



Legend Plate Position #2

| Legend Plate Orientation Position #2 | | | | | | | |
|--------------------------------------|------------------------|------|------|------|------|------|------|
| Legend Plate | Operator | A | B | C | D | E | F |
| KN2 | Standard Push Button | 1.62 | 1.31 | 1.44 | 2.25 | 1.75 | 0.88 |
| KN5 | 1.375 in Dia. Mushroom | 1.62 | 1.31 | 1.44 | 2.25 | 1.75 | 0.88 |
| | 2.25 in Dia. Mushroom | 2.25 | 1.31 | 1.44 | 2.25 | 2.25 | 1.12 |
| | Selector Switch Knobs | 1.62 | 1.31 | 1.44 | 2.25 | 1.75 | 0.88 |
| KN3 | Standard Push Button | 1.75 | 1.31 | 1.44 | 2.25 | 2.00 | 0.88 |
| | 1.375 in Dia. Mushroom | 1.75 | 1.31 | 1.44 | 2.25 | 2.00 | 0.88 |
| | 2.25 in Dia. Mushroom | 2.25 | 1.31 | 1.44 | 2.25 | 2.25 | 1.12 |
| | Selector Switch Knobs | 1.75 | 1.31 | 1.44 | 2.25 | 2.00 | 0.88 |
| KN4 | Standard Push Button | 1.62 | 1.31 | 1.44 | 2.25 | 1.94 | 1.00 |
| | 1.375 in Dia. Mushroom | 1.62 | 1.31 | 1.44 | 2.25 | 1.94 | 1.00 |
| | 2.25 in Dia. Mushroom | 2.25 | 1.31 | 1.44 | 2.25 | 2.25 | 1.12 |
| | Selector Switch Knobs | 1.62 | 1.31 | 1.44 | 2.25 | 1.94 | 1.00 |
| KN6 | Standard Push Button | 2.25 | 1.31 | 1.62 | 2.38 | 2.38 | 0.88 |
| | 1.375 in Dia. Mushroom | 2.25 | 1.31 | 1.62 | 2.38 | 2.38 | 0.88 |
| | 2.25 in Dia. Mushroom | 2.25 | 1.31 | 1.62 | 2.38 | 2.38 | 1.12 |
| | Selector Switch Knobs | 2.25 | 1.31 | 1.62 | 2.38 | 2.38 | 0.88 |

| Special Legend Plates | |
|-----------------------|---|
| Reference | Standard Markings |
| 9001KN500 | (For Use with Dual Function Operators: KR6, KR7 and KR67) |

| Reference | Green | Red |
|-----------|---------|---------|
| KN500 | Blank | Blank |
| KN501 | Start | Stop |
| KN502 | On | Off |
| Reference | Black | Black |
| KN520 | Blank | Blank |
| KN521 | Start | Stop |
| KN522 | On | Off |
| KN523 | Forward | Reverse |
| KN524 | Up | Down |
| KN525 | High | Low |
| KN526 | Open | Close |

Harmony™ 9001K/SK/KX

30 mm push buttons

9001K – Accessories

Note: When ordering, add prefix “9001” to the reference.

| Padlock Attachments | | | |
|---------------------|--|--|-------------|
| Image | Used On | Description | Reference |
| | Non-illuminated push button — Standard or mushroom (KR4, KR5 mushroom buttons only). | Holds button in depressed position and can be padlocked. | K4 |
| | Non-illuminated push button with or without protective boots. | Holds button in depressed position when padlocked. | K5 |
| | Non-illuminated push buttons with or without protective boots. | Holds button in depressed position when padlocked. | K97 |
| | Non-illuminated push buttons, cover type attachment. KR, SKR | Attachment can be padlocked. Does not hold button in depressed position. | K6 |
| | Push buttons, cover type attachment. | Spring loaded cover cannot be padlocked. Does not hold button in depressed position. | K60 |
| | Push-pull operator and illuminated push buttons. KR8, KR9 | Holds button in depressed position and can be padlocked. | K62 |
| | KR11U and KR12U Interlocked Assembly | Holds maintained button in depressed position and can be padlocked. | K96 |
| | 9001KR9 Push-pull operators— Non-Illuminated and Illuminated | Holds button in depressed position. Can be padlocked. | K162 |

Mushroom Button Guards



Aluminum Mushroom Guard for 1.375 in Mushroom Button Operator (KR4, KR24) Yellow Plastic Extended Mushroom Guard for 1.375 in and 1.625 in Mushroom Button Operators Aluminum Mushroom Guard for 2.25 in Mushroom Button Operator

| Reference | Reference | Used On | Reference | Used On |
|------------|------------------|----------|-------------|---------|
| K48 | K56▲ (1) | KR4 | K68 | KR5 |
| | K56■M (2) | KR8, KR9 | K685 | KR25 |

(1) Replace ▲ with B=Black, G=Green, R=Red or Y=Yellow.
 (2) Replace ■ with R=Red or Y=Yellow. The mushroom guard has finger holes for push-pull operators.

| Padlock Attachments | | | |
|---------------------|---|--|-------------|
| Image | Used On | Description | Reference |
| | Selector switches and potentiometers (will not work with gloved-hand knob). | Cover type attachment that can be padlocked to keep unauthorized personnel from tampering with the operator. | K7 |
| | Selector switches and potentiometers (will not work with gloved-hand knob). | Same as 9001K7 but with spring loaded lockout cover. | K107 |
| | Illuminated push buttons (with or without guard) and key operated push buttons. | Cover type attachment that can be padlocked to keep unauthorized personnel from tampering with the operator. | K108 |
| | Illuminated push buttons (with or without guard) and key operated push buttons. | Same as 9001K108 but with spring loaded lockout cover. | K109 |
| | Maintained push-pull operators using 1.375 in dia. mushroom buttons (-20 series as shown on page 28). | Cover type attachment that holds mushroom button in depressed position and can be padlocked. | K110 |

Protective Boots



These 9001KU protective boots are recommended for very dirty environments or severe hose down, but they are not required for UL Type 4 rating on the 9001K operators. The 9001K1 wrench (see page 29) is required for installation of these boots.

| For Non-Illuminated Push Buttons (3) | | Clear Color for | Reference |
|--------------------------------------|------------|--|-------------|
| Color | Reference | Standard knob selector switch | KU17 |
| Black | KU1 | Gloved-hand cap for use on standard knob selector switch | KU18 |
| Red | KU2 | | |
| Blue | KU3 | | |
| Brown | KU4 | Standard pilot light and maintained contact push buttons | KU27 |
| Green | KU5 | | |
| Yellow | KU6 | | |
| Clear | KU7 | Push-to-test and illuminated push button without guard | KU37 |
| Clear | KU8 | Illuminated push button with guard | KU47 |

(3) Use KU27 for maintained contact push buttons.

Closing Plates



| Description | Reference |
|-------------|----------------|
| Gray | K51 (4) |
| Black | K52 (4) |

(4) Meets UL and NEMA 1, 2, 3, 4, 4X, 6, 12 and 13.

Harmony™ 9001K/SK/KX

30 mm push buttons

9001K – Accessories

Note: When ordering, add prefix “9001” to the reference.

| Accessories | | | | | | | |
|---|---------------|---------------|--------------|--|-------------|-------------|--------------|
| Description | Color | Reference | Package Qty. | Description | Color | Reference | Package Qty. |
|  <p>Color inserts for KR1, KR2, KR3, KR11, KR12, KRD, T, TRD</p> | Black | T8BK | 10 |  <p>1-3/8 in Mushroom Knob for Illuminated Push Buttons K2L (9)</p> | Amber | A20 | 1 |
| | Blue | T8BE | | | Blue | L20 | |
| | Gray | T8GY | | | Clear | C20 | |
| | Green | T8GN | | | Green | G20 | |
| | Orange | T8OE | | | Red | R20 | |
| | Red | T8RD | | | White | W20 | |
| | Universal (1) | T8U | 7 | | Yellow | Y20 | |
| | White | T8WH | 10 |  <p>2-1/4 in Mushroom Knob for Illuminated Push Buttons K2L (9)</p> | Amber | A21 | 1 |
| | Yellow | T8YW | | | Blue | L21 | |
| | Black | K16B | 1 | | Clear | C21 | |
| | Blue | K16L | | | Green | G21 | |
| | Green | K16G | | Red | R21 | | |
| | Orange | K16S | | White | W21 | | |
| | Red | K16R | | Yellow | Y21 | | |
| | Red (2) | K16R05 | |  <p>Plastic Fresnel Pilot Light Lens for KP, KT</p> | Amber | A31 | 1 |
| | Yellow | K16Y | | | Blue | L31 | |
| | Black | K17B | 1 | | Clear | C31 | |
| | Blue | K17L | | | Green | G31 | |
| | Green | K17G | | Red | R31 | | |
| | Orange | K17S | | White | W31 | | |
| | Red | K17R | | Yellow | Y31 | | |
| | Red (2) | K17R05 | |  <p>Domed Plastic Pilot Light Lens for KP, KT</p> | Amber | A9 | 1 |
| | Yellow | K17Y | | | Blue | L9 | |
| | Black | K92B | 1 | | Clear | C9 | |
| | Blue | K92L | | | Green | G9 | |
| | Green | K92G | | Red | R9 | | |
| | Orange | K92S | | White | W9 | | |
| | Red | K92R | | Yellow | Y9 | | |
| | Yellow | K92Y | |  <p>Glass Pilot Light Lens for KP, KT</p> | Amber | A6 | 1 |
| | Black | K93B | 1 | | Blue | L6 | |
| | Blue | K93L | | | Clear | C6 | |
| | Green | K93G | | | Green | G6 | |
| | Orange | K93S | | Red | R6 | | |
| | Red | K93R | | White | W6 | | |
| | Yellow | K93Y | | Yellow | Y6 | | |
| | Amber | A22 | 1 |  <p>Standard Selector Switch Knob for 9001K Selector Switches</p> | Amber | A8 | 1 |
| | Black (7) | B23 | | | Black (7) | B11 | |
| | Blue | L22 | | | Blue | L8 | |
| | Clear | C22 | | | Clear | C8 | |
| | Green | G22 | | Green | G8 | | |
| | Orange (7) | S23 | | Orange (7) | S11 | | |
| | Red | R22 | | Red | R8 | | |
| | Red (10) | R2205 | | White | W8 | | |
| | White | W22 | | Yellow | Y8 | | |
| | Yellow | Y22 | |  <p>Gloved-Hand Selector Switch Knob for 9001K Selector Switches</p> | Amber | A24 | 1 |
| | Black | B19 | 10 | | Black (7) | B25 | |
| | Green | G19 | | | Blue | L24 | |
| | Red | R19 | | | Clear | C24 | |
| | Universal (8) | U19 | | Green | G24 | | |
| | Amber | A7 | 1 | Orange (7) | S25 | | |
| | Blue | L7 | | Red | R24 | | |
| | Clear | C7 | | White | W24 | | |
| | Green | G7 | | Yellow | Y24 | | |
| | Red | R7 | |  <p>Color Inserts for KQ and TQ Selector Push Buttons</p> | Black | T5BK | 10 |
| | White | W7 | | | Blue | T5BE | |
| | Yellow | Y7 | | | Green | T5GN | |
| | Red | R94 | 1 | | Orange | T5OE | |
| | Red | K92RM | 1 | Red | T5RD | | |
| | Green | K92GM | | White | T5WH | | |
| | Black | K92BM | | Yellow | T5YW | | |
| | Red | K93RM | 1 |  <p>Selector Switch Cams</p> | Description | Cam | Reference |
| | Green | K93GM | | | B | | K13B |
| | Black | K93BM | | | C | | K13C |
| | Red | K94RM | 1 | | D | | K13D |
| | Green | K94GM | | E | | K13E | |
| | Black | K94BM | | F | | K13F | |
| | Red | K95RM | 1 | G | | K13G | |
| | Green | K95GM | | H | | K13H | |
| | Black | K95BM | | J | | K13J | |
| | Red | K95RM | 1 | L | | K13L | |
| | Green | K95GM | | M | | K13M | |
| | Black | K95BM | | | | | |

(1) Includes one each of the following color inserts: Black, Red, Green, Yellow, Orange, Blue, and White.
 (2) “EMERGENCY STOP” is in raised letters and hot stamped white across the front of the mushroom button.
 (3) The mushroom button cap listed here may be assembled to a 9001KR1U to form a 9001KR4.
 (4) The mushroom button cap listed here may be assembled to a 9001KR1U to form a 9001KR5.
 (5) The mushroom button cap listed here may be assembled to a 9001KR20 to form a 9001KR24.
 (6) The mushroom button cap listed here may be assembled to a 9001KR20 to form a 9001KR25.
 (7) These color caps are opaque and are for use on non-illuminated operators only.
 (8) Includes two of each of the following color inserts: Black, Red, and Green.
 (9) May be used on KR8 and KR9 operators. Order mushroom button and K54 adapter (no charge) from page 29. Using the K54 adapter voids Type 6 rating.
 (10) Red knob with “Push Emergency Stop” marked on top of knob.

Harmony™ 9001K/SK/KX

30 mm push buttons

9001K – Replacement parts

| Ring Nuts | |
|------------------------|------------|
| Used On | Reference |
| K1L | 9001K44 |
| K30-K37 | 9001K45 |
| K70-K73 | 9001K45 |
| K20, K21, K22, K23 | 9001K45 |
| K20, K21, K22, K23 (1) | 9001K46 |
| K2L | 9001K49 |
| K3L (complete) | 9001K111 |
| K3L (metal top only) | 6515802701 |
| KP, KTR | 9001K41 |
| KR1 | 9001K41 |
| KR11 | 9001K42 |
| KR12 (1) | 9001K42 |
| KR12 (2) | 9001K41 |
| KR13, 14, 15 | 9001K55 |
| KR2 | 9001K42 |
| KR20 | 9001K49 |
| KR24 | 9001K49 |
| KR25 | 9001K49 |
| KR3 | 9001K40 |
| KR4 | 9001K41 |
| KR5 | 9001K41 |
| KR6 | 9001K47 |
| KR67 | 9001K47 |
| KR7 | 9001K47 |
| KR8 | 9001K58 |
| KR9 | 9001K41 |
| KS | 9001K45 |
| KS (3) | 9001K46 |
| KT | 9001K49 |

(1) Maintained button of two button operator.

(2) Momentary button of two button operator.

(3) Secondary ring nut (holds knob on selector switch or potentiometer).

Replacement Lamps For Series A–F (black) Light Modules

| Light Module Reference | Lamp Number (ANSI) | Schneider Electric Replacement Lamp Reference |
|------------------------|--------------------|---|
| KM1 | GE44 (4) | — |
| KM2 | GE1490 | 2550101003 |
| KM3 | GE44 (4) | — |
| KM4 | GE1490 | 2550101003 |
| KM5 | GE44 (4) | — |
| KM6 | GE44 (4) | — |
| KM7 | GE44 (4) | — |
| KM8 | GE44 (4) | — |
| KM9 | GE755 | 2550101020 |
| KM11 | CMDK1A5 | 2550105014 |
| KM12 | CMDK1A5 | 2550105014 |
| KM13 | CMDK1A5 | 2550105014 |
| KM14 | CMDK1A5 | 2550105014 |
| KM15 | CMDK1A5 | 2550105014 |
| KM21 | SYL12PSB | 2550105003 |
| KM22 | SYL12PSB | 2550105003 |
| KM23 | SYL28PSB | 2550105008 |
| KM25 | SYL120PSB | 2550105005 |
| KM31 | SYL6PSB | 2550105007 |
| KM32 | SYL12PSB | 2550105003 |
| KM34 | SYL24PSB | 2550105004 |
| KM35 | SYL28PSB | 2550105008 |
| KM36 | SYL48PSB | 2550105009 |
| KM37 | SYL60PSB | 2550105010 |
| KM38 | SYL120PSB | 2550105005 |

(4) GE44 and GE755 are interchangeable (GE755 gives longer life). If a GE44 lamp is ordered, a GE755 (2550101020) will be substituted. For a replacement lamp in a current series light module see the light module listing on page 24.

Product range:
page 5Specifications:
page 7Dimensions:
page 30Mounting:
page 31

| Repair Parts | |
|---|------------|
| Description | Reference |
| E10 Key | 2941101100 |
| Gray cap for KR11 or KR12 | 3105217001 |
| Clear plastic top (only) for 9001K44 Ring Nut | 4487D63XI |
| Gasket for 9001K Push-pull Knob | 6509701801 |
| Gasket for Plastic Illuminated Lens | 6509701901 |
| Gasket for 9001K selector switch knob | 3105406401 |
| Black Compensating Gasket (9001K Operators) | 6509702001 |
| Liner for Non-Illuminated Operators | 6509704901 |
| Locking Thrust Washer | 6512231201 |
| Nylon Spacer | 6509705001 |
| Push-pull Mushroom Adapter (5) | 9001K54 |
| Rubber Boot for Joystick | 6512243201 |
| Knob on Joysticks without latch | 4458D20X3 |
| Knob for SK Potentiometer | 3105404408 |
| Fingersafe Cover for 9001KM | 6508804101 |

(5) Allows Type -20 and -21 mushroom color caps to be used on push-pull operators. Use of 9001K54 voids Type 6 rating.

KU Replacement Ring Nuts (Threaded Inside and Out)

| Used On | Reference |
|-----------------------------------|------------|
| KU1 through KU8, KU27, KU37, KU47 | 3105204101 |
| KU17, KU18 | 3105205901 |

Interlock



For mechanically interlocking two push buttons so that only one button can be depressed at a time. A K3 attachment is furnished with the 9001KR11 and KR12 operators. However, these are maintained operators and the K3 interlock serves to release one of the buttons when the other is depressed. When used with momentary contact buttons, the K3 interlock does not hold the buttons in the depressed position. It simply prevents pushing both buttons at the same time.

The K3 interlock is mounted behind the operators. Operators not included.

Reference

9001K3

Screwdriver

Reference



9001K69

Used to tighten mounting screws on contact blocks and light modules.

Wrenches

K95



K1



Where Used

Reference

For tightening ring nuts on 22 and 30 mm control units

9001K95

For protective cap kits

9001K1

Harmony™ 9001K/SK/KX

30 mm push buttons

9001K

Dimensions

Push buttons



e: panel thickness 1 to 6 mm

Full guard
9001KR1●●●



No guard
9001KR3●●●



No guard with extended guard
9001KR2●●●



Mushroom head push buttons

Spring return 35 mm:
9001KR24●H13,
9001KR4RH6,
9001KR9R20H6

Spring return 57 mm:
9001KR25●H13,
9001KR5RH6
Spring return 60 mm:
9001KR25●M

Push-pull 35 mm:
9001KR9R20H6
Push-pull 40 mm:
9001KR24●M
9001KR9●M94
Push-pull 41 mm:
9001KR9●H13,
9001KR9R94H13
9001KR9RH6
9001KR8●H25
Push-pull 57 mm:
9001KR9R21H6
Push-pull 60 mm:
9001KR9●M95

Spring return 35, 57 and 60 mm a = 28 mm

Push-pull 35 to 60 mm a = 32 mm



e: panel thickness 1 to 6 mm

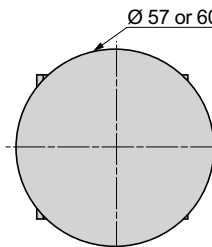

Turn-to-release 9001KR16H13, 9001KR16H2 and 9001KR16



e: panel thickness 1 to 6 mm



Selector switches

Gloved handle 9001KS●●FBH●●



e: panel thickness 1 to 6 mm



Dual Dimensions: in (mm)

Dimensions (continued)

Selector switches (continued)



e: panel thickness 1 to 6 mm

Key switches 9001KS●●K●●● (for the chromium metal bezel range only)

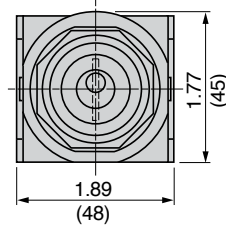

Mounting

Contact block mounting position

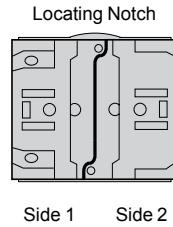

1 For Maximum Contact Block Usage, see page 22.

Panel cut-out



Individual cut-outs detail

2 alternatives



Preferred Cut-Out

Alternate Cut-Out

Use Greenlee Tool #60242 for punching hole and notch.

| Type of 9001K unit | Legend plate | a: in (mm) | b: in (mm) |
|---|--------------|-------------|-------------|
| All units except 57 mm mushroom head push buttons | 9001KN2●● | 2.25 (57.2) | 1.75 (44.5) |
| | 9001KN3●● | 2.25 (57.2) | 2.00 (50.8) |
| 57 mm mushroom head push buttons | 9001KN2●● | 2.25 (57.2) | 2.25 (57.2) |
| | 9001KN3●● | 2.25 (57.2) | 2.25 (57.2) |

Dual Dimensions: in (mm)

Dimensions (continued)

Pilot lights

With BA 9s bulb 9001KP●●●



e: panel thickness 1 to 6 mm

Illuminated mushroom head push buttons

9001KR●P●●●

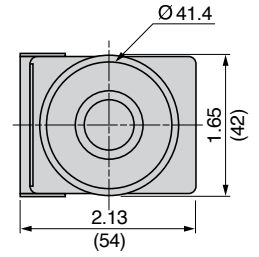

e: panel thickness 1 to 6 mm

Illuminated push buttons, spring return

Full guard 9001K3L●●●●H13



e: panel thickness 1 to 6 mm

Joystick controllers (for the chromium metal bezel range only)

9001K●●H●

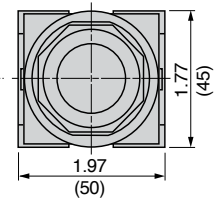

e: panel thickness 1 to 6 mm

No guard 9001K2L●●●●H13



e: panel thickness 1 to 6 mm

Heads for spring return push buttons

9001KR●U

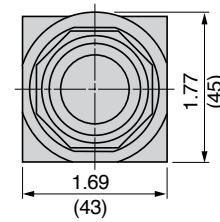

Boots for push buttons

9001KU●

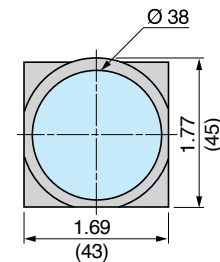
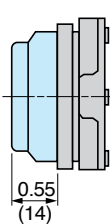
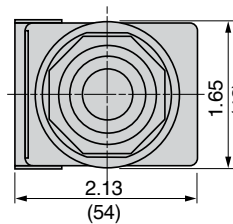
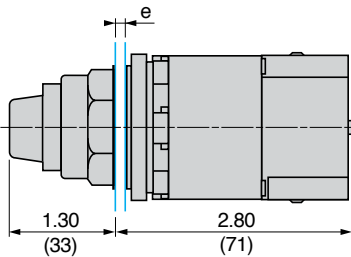

e: panel thickness 1 to 6 mm

Dual Dimensions: in (mm)

Dimensions (continued)

Rod for wobble stick

9001K8



Light blocks for pilot lights and illuminated push buttons

9001KM●



e: panel thickness 1 to 6 mm

Contact blocks for push buttons (including illuminated)

9001KA●

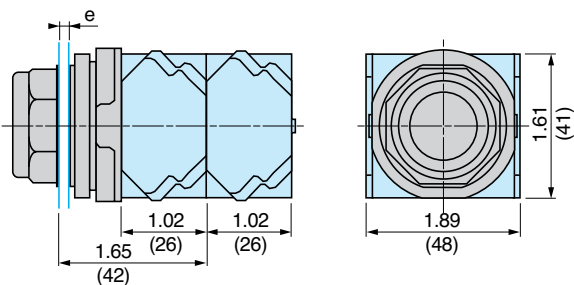

e: panel thickness 1 to 6 mm

It is not possible to mount complementary contact blocks 9001KA4 to KA6.

Legend plates

Aluminium plates 9001KN1●●, 9001KN2●●, 9001KN7●●



| Legend plate | a: in (mm) | b: in (mm) |
|--------------|------------|------------|
| 9001KN2●● | 1.625 (41) | 0.969 (24) |
| 9001KN3●● | 1.750 (45) | 1.234 (31) |

Plastic plates 9001KN1●●P, 9001KN2●●P, 9001KN7●●P



| Legend plate | a: in (mm) | b: in (mm) |
|--------------|------------|------------|
| 9001KN1●●P | 2.25 (57) | 2.25 (57) |
| 9001KN2●●P | 1.75 (45) | 1.75 (45) |
| 9001KN7●●P | 2.50 (63) | 2.50 (63) |

Interlocked push buttons

9001KR11, 9001KR12, and 9001K3 interlock



Potentiometer

9001K20 (1), 9001K21 (2)

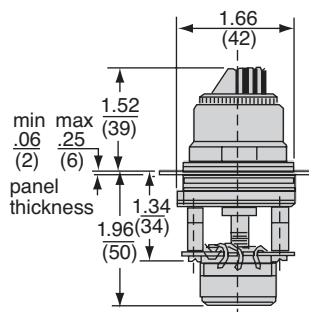

(1) Without potentiometer

(2) With potentiometer

9001K22 (1), 9001K23 (2)

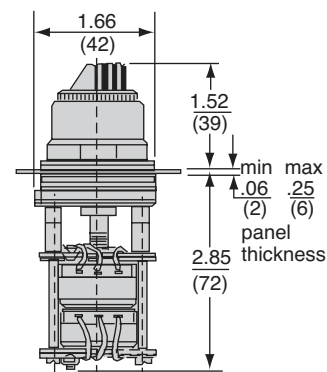

(1) Without potentiometer

(2) With potentiometer

Harmony™ 9001K/SK/KX

30 mm push buttons

9001K

Dimensions (continued)

Time delay push button

9001KRD



| | a | b |
|-------------|----------------------|-------|
| 9001KRD1UH● | Full guard 9/16 | 2-1/2 |
| 9001KRD2UH● | Extended guard 11/16 | 2-1/2 |
| 9001KRD3UH● | No guard 9/16 | 2-1/2 |

Alternate action—Push-on, push-off module

9001K85



Emergency break glass operator

9001K15



Rocker arm operating lever

9001K50

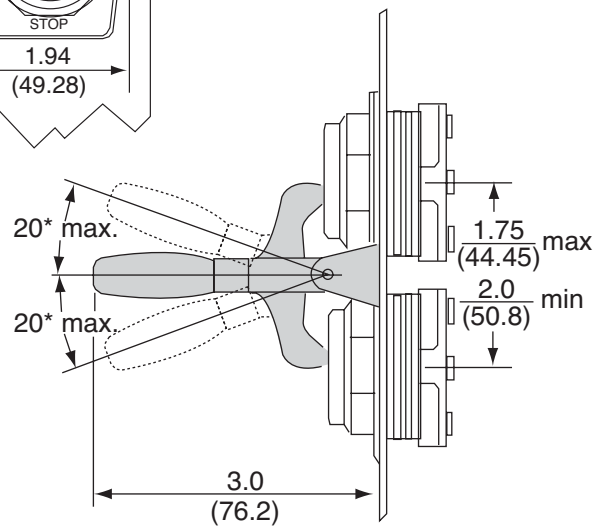

Dual Dimensions: in (mm)

Harmony™ 9001K/SK/KX

30 mm push buttons

9001K

Dimensions (continued)

Padlock attachments

9001K4



9001K96



9001K7, 9001K107, 9001K108, 9001K109, 9001K113



9001K6, 9001K60, 9001K97



9001K62



9001K5



Mushroom button guards

9001K48



9001K56Y, 9001K56YM (1)



9001K68



(1) 9001K56YM includes finger holes.

Dual Dimensions: in (mm)

Complete units

Contact functions

Push buttons, spring return



Full guard

9001SKR1●●● See page 41



No guard

9001SKR3●●● See page 41



Extended guard

9001SKR2●●● See page 41

Mushroom head push buttons



Spring return 1-3/8 or 2-1/4 in (35 or 57 mm)

9001SKR2●●H13 See page 41



Push-pull 1-3/8, 1-5/8 or 2-1/4 in (35, 41 or 57 mm)

9001SKR●●● See page 41



Turn-to-release, trigger action

9001SKR16 (1) See page 43

Selector switches



Selector switches

9001SKS●●FBH●● See page 44

Light functions

Pilot lights



BA 9s base mounted super bright LED

9001SKP●●● See page 48



BA 9s incandescent bulb

9001SKP●●● See page 48

(1) Complies with EN418/ISO13850 standards for Emergency Stop push buttons when used with circular Legend Plate 9001KN8330 (90 mm diameter) or 9001KN9330 (60 mm diameter). See page 56.

Harmony™ 9001K/SK/KX 30 mm push buttons

9001SK – Complete units, components and accessories

Complete units

Combined contact and light functions

Illuminated push buttons, spring return



Full guard

9001SK1L●●● See page 42



No guard

9001SK2L●●● See page 42



Push-to-test, no guard

9001SKT●●●31 See page 48

1-5/8 in (41 mm) mushroom head illuminated push buttons

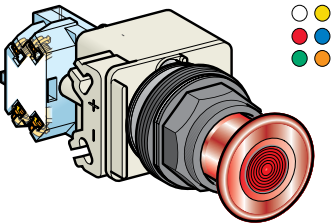

2-Position, push-pull

9001SKR9P●●● See page 43



3-Position, push-pull

9001SKR8P●●● See page 43

Separate components and accessories



Complete units are composed of:

- 1 - Contact block
- 2 - Light module with lamp
- 3 - Black compensation gaskets
- 4 - Legend plate
- 5 - Locking thrust washer
- 6 - Ring nut
- 7 - Color cap
- 8 - Color insert

Specifications:
page 38

References:
page 41

Dimensions:
page 60

Mounting:
page 61

Harmony™ 9001K/SK/KX

30 mm push buttons

9001SK

| Environmental specifications | | | |
|---|---|---------|--|
| Conforming to standards |   | | EN/IEC 60947-1, EN/IEC 60947-5-1, EN/IEC 60947-5-4, JIS C 4520 and 852, UL 508, CSA C22-2 n° 14, CE marked, RoHS compliant |
| Product certifications |  File E78403 CCN NKCR  File LR25490 Class 3211-03 | | UL File E78403, CCN NKCR and CSA File LR25490, Class 3211-03 |
| Protective treatment standard version | | | "TC" |
| Ambient air temperature around the device | Storage | °F (°C) | -40 to +158 (-40 to +70) |
| | Operation | °F (°C) | -13 to +158 (-25 to +70) |
| Vibration resistance | Conforming to IEC 60068-2-6 | | Frequency: 2 to 500 Hz: 7gn Ford Standard EA-1 |
| Shock resistance | Conforming to IEC 60068-2-27 | | Half sine wave: 50 gn |
| Electric shock protection | Conforming to IEC 61140 | | Class II |
| Degree of protection | Conforming to EN/IEC 60529 | | IP 66 |
| | Conforming to NEMA | | Types 1, 2, 3, 3R, 4, 12 and 13 |
| Mechanical life (in millions of operating cycles) | Push buttons, spring return | | 5 |
| | Illuminated push buttons | | 5 |
| | Selector switches and key switches | | 0.5 |
| Mounting position | | | All positions |

| Electrical characteristics of contact blocks | | | |
|---|--|--|---|
| Rated operational characteristics | ~ AC-15 | | 3 A, 240 V |
| | --- DC-13 | | 0.55 A, 125 V |
| Rated insulation voltage | Conforming to EN/IEC 60947-1 | V | U _i = 250 degree of pollution 3 (except pilot lights with incandescent bulb: degree of pollution 2) |
| Rated impulse withstand voltage | Conforming to EN/IEC 60947-1 | kV | U _{imp} = 2.5 |
| Contact material | Normal environment and usage | | Silver alloy |
| Contact operation | "N/C" ou "N/O" | | Slow break |
| Positive operation | Conforming to EN/IEC 60947-5-1 | N | N/C contact(s) with positive opening operation |
| Short-circuit protection | Conforming to EN/IEC 60947-5-1 | A | Cartridge fuse mounted upstream: 10 |
| Cabling capacity (9001KA contact blocks and 9001KM light modules) | Conforming to EN/IEC 60947-1 | mm² mm² | Screw clamp terminals (cross headed/slotted screw) Mini: 1 x 0.22 Maxi: 2 x 1.5 Recommended tightening torque: 0.8 N.m (10 in-lbs) |
| Thermal current | I _{th} | A | 10 |
| Maximum operation current | a.c. supply: utilization category AC-15 NEMA A600 | V | Contact making capacity |
| | | A | 120 240 480 600 |
| | | VA | 60 30 15 12 |
| | d.c. supply: utilization category DC-13 NEMA Q600 | VA | 7200 7200 7200 7200 |
| | | V | Breaking capacity |
| | | A | 120 240 480 600 |
| VA | 6 3 1.5 1.2 | | |
| VA | 720 720 720 720 | | |
| | | V | Contact making capacity and breaking capacity |
| | | A | 125 250 600 0.1 |
| | | A | 0.55 0.27 0.1 |

Basic Operators

(For Color Caps, Mushroom Buttons, Knobs, Selector Switch Cams, Contact Blocks, Light Modules and Legend Plates, see page 51.)

| Description | UL Types/NEMA Types |
|---|--|
| | 4, 4X, 13 |
| Non Illuminated Push Button (Full Guard) | 9001SKR1 |
| Non Illuminated Push Button (Extended Guard) | 9001SKR2 |
| Non Illuminated Push Button (No Guard) | 9001SKR3 |
| Non Illuminated Push Button (Mushroom Button/screw on) | 9001SKR20 |
| Non Illuminated Dual Push Button (Momentary) | – |
| Non Illuminated Dual Push Button (Momentary Interlocked) | – |
| Non Illuminated Dual Push Button (Maintained Interlocked) | – |
| Momentary Pull - Maintained Neutral - Momentary Push | 9001SKR8 (1) |
| Maintained Pull - Maintained Push | 9001SKR9 (1) |
| Illuminated Push Button (Full Guard - Plastic Top) | 9001SK1L (2) |
| Illuminated Push Button and Push-to-test (No Guard) | 9001SK2L (2) (3) |
| Illuminated Push Button (Full Guard - Metal Top) | – |
| Standard Pilot Light | 9001SKP |
| 2-Position Selector Switch | 9001SKS1 (1), 9001SKS2 (1), 9001SKS3 (1) |
| 3-Position Selector Switch | 9001SKS4 (1), 9001SKS5 (1), 9001SKS6 (1), 9001SKS7 (1) |
| 4-Position Selector Switch | 9001SKS8 (1) |
| Trigger-Action Emergency Stop | 9001SKR16 (1) |

(1) Operator can be converted to an illuminated operator by removing the liner (6509704901) and adding a light module.

(2) Operator can be converted to a non-illuminated operator by adding liner (6509704901).

(3) Operator includes jumper wires for push-to-test conversion.

Non Hazardous Locations:



Hazardous Locations (Reed contact blocks, see page 53):



Harmony™ 9001K/SK/KX

30 mm push buttons

9001SK

9001SK Operator Materials:

Push Button and Push-to-test Pilot Light
(9001SKR and 9001SKT)

- Base – Thermoplastic Polyester
- Stem – Acetal (non-illuminated push button)
Thermoplastic Polyester (illuminated push button
and push-to-test pilot light)
- Seal – Nitrile
- Gasket – Nitrile
- Spring – 302 Stainless Steel
- Spring Support – CRS
- Lock Ring – Nylon
- Trim Washer – Polypropylene
- Locking Thrust Washer – Thermoplastic Polyester
- Ring Nut – Thermoplastic Polyester
- Color Insert – Polyethylene (non-illuminated push button)
- Color Cap – Polycarbonate (illuminated push button and
push-to-test pilot light)
- Mushroom Button – Acetal (non-illuminated push button)
Polycarbonate (illuminated push button)
- Liner – Polypropylene (non-illuminated push button)

Selector Switch (9001SKS)

- Base – Thermoplastic Polyester
- Seal – Nitrile
- Gasket – Nitrile
- Seal Keeper – 302 Stainless Steel
- Spring – 302 Stainless Steel
- Cam Follower – Delrin 100
- Bearing Washer – Polyester Film
- Cam Carrier – Trogamid
- Cam Profile – Delrin 100
- Liner – Polypropylene (non-illuminated only)
- Knob – Polycarbonate
- Trim Washer – Polypropylene
- Locking Thrust Washer – Thermoplastic Polyester
- Spring Support – CRS

Pilot Light (9001SKP)

- Gasket – Nitrile
- Base – Thermoplastic Polyester
- Trim Washer – Polypropylene
- Locking Thrust Washer – Thermoplastic Polyester
- Ring Nut – Thermoplastic Polyester
- Color Cap – Polycarbonate

Contact Block And Light Module Materials:

Contact Block (9001KA)

- Housing – Amorphous Nylon
- Contact Slider – Phenolic, Nylon or Acetal
- Terminal – Steel
- Saddle Clamp – Steel
- Spring – Stainless Steel
- Contacts – Silver and Copper
- Blade – Beryllium Copper
- Mounting Screw – Steel
- Label – Paper

Light Module (9001KM)

- Housing – Thermoplastic Polyester
- Socket – Steel
- Terminal – Steel with Tin Plate
- Saddle Clamp – Steel
- Translating Pin – Polycarbonate
- Transformer – Thermoplastic Polyester, Steel, Copper,
Polyvinyl Chloride, Polytetrafluorethylene,
Acetate, Paper
- Lamp Spring – Tin Plated Music Wire

Harmony™ 9001K/SK/KX 30 mm push buttons

9001SK – Push buttons and mushroom operators

Note: When ordering, add prefix “9001” to the reference.

**Non-Illuminated Momentary Push Button Operators—UL Types 4, 4X, 13/NEMA 4, 4X, 13
For use in hazardous locations, see page 53.
Contact blocks and legend plate not included unless otherwise noted.**

| Description | Color | Operator with 1 N.O. and 1 N.C. Contact (KA1) | Operator with 1 N.O. Contact (KA2) | Operator with 1 N.C. Contact (KA3) | Operator Only No Contacts (5) |
|---|--------------------------------|---|------------------------------------|------------------------------------|-------------------------------|
|  <p>9001SKR1B Full Guard</p> | Black | SKR1BH13 | SKR1BH5 | SKR1BH6 | SKR1B |
| | Red | SKR1RH13 | SKR1RH5 | SKR1RH6 | SKR1R |
| | Green | SKR1GH13 | SKR1GH5 | SKR1GH6 | SKR1G |
| | Universal (1) | SKR1UH13 | SKR1UH5 | SKR1UH6 | SKR1U |
| | Other (2) | SKR1■H13 | SKR1■H5 | SKR1■H6 | SKR1■ |
|  <p>9001SKR3B No Guard</p> | Black | SKR3BH13 | SKR3BH5 | SKR3BH6 | SKR3B |
| | Red | SKR3RH13 | SKR3RH5 | SKR3RH6 | SKR3R |
| | Green | SKR3GH13 | SKR3GH5 | SKR3GH6 | SKR3G |
| | Universal (1) | SKR3UH13 | SKR3UH5 | SKR3UH6 | SKR3U |
| | Other (2) | SKR3■H13 | SKR3■H5 | SKR3■H6 | SKR3■ |
|  <p>9001SKR2B Extended Guard</p> | Black | SKR2BH13 | SKR2BH5 | SKR2BH6 | SKR2B |
| | Red | SKR2RH13 | SKR2RH5 | SKR2RH6 | SKR2R |
| | Green | SKR2GH13 | SKR2GH5 | SKR2GH6 | SKR2G |
| | Universal (1) | SKR2UH13 | SKR2UH5 | SKR2UH6 | SKR2U |
| | Other (2) | SKR2■ | SKR2■H5 | SKR2■H6 | SKR2■ |
| Snap-In Mushroom Button | | | | | |
|  <p>9001SKR4B 1-3/8 in (35 mm) Mushroom Button</p> | Black | SKR4BH13 | SKR4BH5 | SKR4BH6 | SKR4B |
| | Red | SKR4RH13 | SKR4RH5 | SKR4RH6 | SKR4R |
| | Red (3) | SKR4R05H13 | SKR4R05H5 | SKR4R05H6 | SKR4R05 |
| | Green | SKR4GH13 | SKR4GH5 | SKR4GH6 | SKR4G |
| | Other (4) | SKR4★H13 | SKR4★H5 | SKR4★H6 | SKR4★ |
| Screw-On Mushroom Button with Set Screw Security | | | | | |
|  <p>9001SKR5 2-1/4 in (57 mm) Mushroom Button</p> | Black | SKR24BH13 | SKR24BH5 | SKR24BH6 | SKR24B |
| | Red | SKR24RH13 | SKR24RH5 | SKR24RH6 | SKR24R |
| | Green | SKR24GH13 | SKR24GH5 | SKR24GH6 | SKR24G |
| | Other (4) | SKR24★H13 | SKR24★H5 | SKR24★H6 | SKR24★ |
| | Snap-In Mushroom Button | | | | |
|  <p>9001SKR5 2-1/4 in (57 mm) Mushroom Button</p> | Black | SKR5BH13 | SKR5BH5 | SKR5BH6 | SKR5B |
| | Red | SKR5RH13 | SKR5RH5 | SKR5RH6 | SKR5R |
| | Red (3) | SKR5R05H13 | SKR5R05H5 | SKR5R05H6 | SKR5R05 |
| | Green | SKR5GH13 | SKR5GH5 | SKR5GH6 | SKR5G |
| | Other (4) | SKR5★H13 | SKR5★H5 | SKR5★H6 | SKR5★ |
| Screw-On Mushroom Button with Set Screw Security | | | | | |
|  <p>9001SKR5 2-1/4 in (57 mm) Mushroom Button</p> | Black | SKR25BH13 | SKR25BH5 | SKR25BH6 | SKR25B |
| | Red | SKR25RH13 | SKR25RH5 | SKR25RH6 | SKR25R |
| | Green | SKR25GH13 | SKR25GH5 | SKR25GH6 | SKR25G |
| | Other (4) | SKR25★H13 | SKR25★H5 | SKR25★H6 | SKR25★ |

Color Codes

| Color | ■ SKR1, 2, 3 Place Color Code in Reference | ★ SKR4, 5, 24, 25 Place Color Code in Reference |
|--------|--|---|
| Blue | L | L |
| Yellow | Y | Y |
| White | W | — |
| Orange | S | S |
| Gray | E | — |

(1) The universal push button operators contain one each of the following color inserts: black, red, green, yellow, orange, blue and white.
 (2) Replace ■ with the color code as chosen from the color code table above.
 (3) Knob has the words “Emergency Stop” in raised letters highlighted in white for readability.
 (4) Replace ★ with the color code as chosen from the color code table above.
 (5) These operators can be ordered complete with contact blocks. For maximum block usage, see page 51. Add the “H” number chosen from page 51 to the end of the operator reference number and add the cost of the “H” number to the operator cost.

To select and order Contact Blocks, Light Modules, Knobs, and Accessories, see pages 50 to 59.

Harmony™ 9001K/SK/KX 30 mm push buttons

9001SK – Push buttons and mushroom operators

Note: When ordering, add prefix “9001” to the reference.

Illuminated Push Button Operators—UL Types 4, 4X, 13/NEMA 4, 4X, 13
For use in hazardous locations, see page 53.
Legend plate not included unless otherwise noted.

| Description | Voltage and Frequency | Style | With Red Color Cap and 1 N.O. and 1 N.C. Contact (KA1) | With Green Color Cap and 1 N.O. and 1 N.C. Contact (KA1) | With Other Color Cap Without Contact Blocks (1) (5) |
|--|------------------------|-----------------------|--|--|---|
|  9001SK1L1 Full Guard Illuminated Push Button | 110–120 V, 50–60 Hz | Transformer | SK1L1RH13 | SK1L1GH13 | SK1L1 |
| | 220–240 V, 50–60 Hz | Transformer | SK1L7RH13 | SK1L7GH13 | SK1L7 |
| | 24–28 Vac/Vdc | Full Voltage | SK1L35RH13 | SK1L35GH13 | SK1L35 |
| | For other voltages (2) | Transformer, Flashing | SK1L■RH13 | SK1L■GH13 | SK1L▼ |
| | | Full Voltage | SK1L■RH13 | SK1L■GH13 | SK1L▼ |
| | | Resistor, Neon (3) | SK1L■RH13 | SK1L■GH13 | SK1L▼ |
| LED | SK1L■RH13 | SK1L■GH13 | SK1L▼ (4) | | |
|  9001SK2L1 No Guard Illuminated Push Button | 110–120 V, 50–60 Hz | Transformer | SK2L1RH13 | SK2L1GH13 | SK2L1 |
| | 220–240 V, 50–60 Hz | Transformer | SK2L7RH13 | SK2L7GH13 | SK2L7 |
| | 24–28 Vac/Vdc | Full Voltage | SK2L35RH13 | SK2L35GH13 | SK2L35 |
| | For other voltages (2) | Transformer, Flashing | SK2L■RH13 | SK2L■GH13 | SK2L▼ |
| | | Full Voltage | SK2L■RH13 | SK2L■GH13 | SK2L▼ |
| | | Resistor, Neon (3) | SK2L■RH13 | SK2L■GH13 | SK2L▼ |
| LED | SK2L■RH13 | SK2L■GH13 | SK2L▼ (4) | | |
|  9001SK2L1R20 1-3/8 in (35 mm) Illuminated Mushroom | 110–120 V, 50–60 Hz | Transformer | SK2L1R20H13 | SK2L1G20H13 | Order SK2L▼ (4) (6) |
| | 220–240 V, 50–60 Hz | Transformer | SK2L7R20H13 | SK2L7G20H13 | |
| | 24–28 Vac/Vdc | Full Voltage | SK2L35R20H13 | SK2L35G20H13 | |
| | For other voltages (2) | Transformer, Flashing | SK2L■R20H13 | SK2L■G20H13 | |
| | | Full Voltage | SK2L■R20H13 | SK2L■G20H13 | |
| | | Resistor, Neon (3) | SK2L■R20H13 | SK2L■G20H13 | |
| LED | SK2L■R20H13 | SK2L■G20H13 | | | |
|  9001SK2L1R21 2-1/4 in (57 mm) Illuminated Mushroom | 110–120 V, 50–60 Hz | Transformer | SK2L1R21H13 | SK2L1G21H13 | Order SK2L▼ (4) (6) |
| | 220–240 V, 50–60 Hz | Transformer | SK2L7R21H13 | SK2L7G21H13 | |
| | 24–28 Vac/Vdc | Full Voltage | SK2L35R21H13 | SK2L35G21H13 | |
| | For other voltages (2) | Transformer, Flashing | SK2L■R21H13 | SK2L■G21H13 | |
| | | Full Voltage | SK2L■R21H13 | SK2L■G21H13 | |
| | | Resistor, Neon (3) | SK2L■R21H13 | SK2L■G21H13 | |
| LED | SK2L■R21H13 | SK2L■G21H13 | | | |

(1) These operators can be ordered complete with contact blocks. For maximum block usage, see page 51. Add the “H” number chosen from page 51 to the end of the operator reference number and add the cost of the “H” number to the operator cost.

(2) Replace ■ with the voltage assembly code as chosen from the tables on page 54. EXAMPLE: SK2L■ with 240 Vac/Vdc = SK2L25.

(3) On neon light modules, use clear color caps only.

(4) The cap must be the same color as the LED light module chosen e.g., for red LED, use red color cap.

(5) Replace ▼ with the color code as chosen from the color code table below. EXAMPLE: SK2L35▼ with a blue 1-3/8 in mushroom button = SK2L35L20.

(6) The only difference between a no guard (SK2L) operator and mushroom button operator is the color cap.

Color Caps

| Color | Color Codes | | |
|--------|-------------|---------------------------|---------------------------|
| | SK1L/SK2L | 1-3/8 in (35 mm) Mushroom | 2-1/4 in (57 mm) Mushroom |
| Red | R | R20 | R21 |
| Green | G | G20 | G21 |
| Blue | L | L20 | L21 |
| Yellow | Y | Y20 | Y21 |
| White | W | W20 | W21 |
| Clear | C | C20 | C21 |
| Amber | A | A20 | A21 |

To select and order Contact Blocks, Light Modules, Knobs, and Accessories, see pages 50 to 59.

Harmony™ 9001K/SK/KX

30 mm push buttons

9001SK – Multi-function operators

Note: When ordering, add prefix “9001” to the reference.

30 mm Multi-function Operators — UL Types 4, 4X, 13/NEMA 4, 4X, 13

Non-Illuminated Push-pull Screw-on Mushroom Operators

| Description | Color | With 2 N.C. Contacts (1 KA3, 1 KA5) | With 1 N.O. / 1 N.C. Contact (1 KA1) | Without Contacts (6) | |
|---|--|-------------------------------------|--------------------------------------|----------------------|-------|
| 3-Position | | | | | |
|  <p>9001SKR9R Non-Illuminated 1-5/8 in Diameter Knob Includes 9001KN179WP Legend Plate Marked Pull To Start / Push To Stop</p> | Momentary Pull-Maintained Neutral-Momentary Push (2) (7) | Red | SKR8RH25 | SKR8R | |
| | | Green | SKR8GH25 | SKR8G | |
| | | Other | SKR8■H25 | SKR8■ | |
| 2-Position (1) | | | | | |
| | Maintained Pull-Maintained Push (2) | Red | — | SKR9RH13 | SKR9R |
| | | Green | — | SKR9GH13 | SKR9G |
| | | Other | — | SKR9■H13 | SKR9■ |

Positions for 9001SKR8RH1 or H13

| | PULL | CTR | PUSH |
|-------|------|-----|------|
| (KA1) | | | |
| KA3 | x | O | O |
| KA2 | O | O | x |

O = contact open; x = contact closed

Positions for 9001SKR8H25

| | PULL | CTR | PUSH |
|-----|------|-----|------|
| | | | |
| KA3 | x | O | O |
| KA5 | x | x | O |
| KA2 | O | O | x |

Non-Illuminated Turn-to-release Mushroom Operators

| Description | Color | With 1 N.O. Contact (KA1) | With 2 N.O. / 2 N.C. Contacts (2 KA1) | Without Contacts |
|---|-------|---------------------------|---------------------------------------|------------------|
|  <p>9001SKR16H2</p> <p>2-Position Trigger-Action, Turn-to-Release 1-5/8 in. (40 mm) Non-Removal Plastic Mushroom</p> <p>Complies with EN418/ISO13850 standards for Emergency Stop push buttons when used with circular Legend Plate 9001KN8330 (90 mm diameter) or 9001KN9330 (60 mm diameter). See page 56.</p> | Red | SKR16H13 | SKR16H2 | SKR16 |

Illuminated Push-pull Mushroom Operators

| Description | Voltage | With Red Knob and 2 N.C. Contacts (1 KA3, 1 KA5) | With Other Color Knob and 2 N.C. Contacts | With Other Color Knob Without Contacts (6) | |
|--|--|--|---|--|---------|
| 3-Position | | | | | |
|  <p>9001SKR9P1 1-5/8 in Diameter Knob with "Pull To Start / Push To Stop" 9001KN379 Legend Plate For 1-3/8 in or 2-1/4 in Diameter Knob (1)</p> | Momentary Pull-Maintained Neutral-Momentary Push (2) (3) (7) | 110–120 V, 50–60 Hz | SKR8P1RH25 | SKR8P1■H25 | SKR8P1■ |
| | | Other—Transformer, LED, Flashing (4) | SKR8P♦RH25 | SKR8P♦■H25 | SKR8P♦■ |
| | | Other—Full Voltage, Resistor, Neon (5) | SKR8P♦RH25 | SKR8P♦■H25 | SKR8P♦■ |
| 2-Position | | | | | |
| | Maintained Pull-Maintained Push (2) (3) (7) | 110–120 V, 50–60 Hz | SKR9P1RH13 | SKR9P1■H13 | SKR9P1■ |
| | | Other—Transformer, L.E.D., Flashing (4) | SKR9P♦RH13 | SKR9P♦■H13 | SKR9P♦■ |
| | | Other—Full Voltage, Resistor, Neon (5) | SKR9P♦RH13 | SKR9P♦■H13 | SKR9P♦■ |

- To obtain a red knob with "Push Emergency Stop" printed on the red knob—substitute R05 in place of "R".
- Replace ■ with the color code as chosen from the color code at right. Example: SKR9■ with a yellow knob = SKR9Y
- Replace ♦ with the voltage assembly code as chosen from the tables on page 54. Example: SKR8P♦ with 277 V 50–60 Hz = SKR8P8
- The knob must be the same color as the LED light module chosen; e.g., for green LED, use green knob.
- On neon light modules, use clear knobs only.
- These operators can be ordered complete with contact blocks. For maximum block usage, see page 51. Add the "H" number chosen from page 51 to the end of the operator reference number and add the cost of the "H" number to the operator cost.
- For positions, refer to the two tables below.

Color Codes

| Color | SKR11, SKR12 | SKR8, SKR9 |
|------------|--------------|------------|
| Black (8) | B | B |
| Red | R | R |
| Green | G | G |
| Blue | L | L |
| Yellow | Y | Y |
| White | W | W |
| Orange (8) | S | S |
| Clear | — | C |
| Amber | — | A |
| Gray | E | — |

(8) These colors are not available on illuminated push-pull operators.

To select and order Contact Blocks, Light Modules, Knobs, and Accessories, see pages 50 to 59.

Harmony™ 9001K/SK/KX

30 mm push buttons

9001SK – Selector switches

Note: When ordering, add prefix “9001” to the reference.

| 2-Position Selector Switches | | | | | 1—Contact Closed | | 0—Contact Open | |
|------------------------------|--|----|------------------------------------|-----------|------------------|----------|----------------|-------|
| Contact Block Required | Quantity and Type KA1 or KA2 or KA3 | | Mount on Side KA1 or KA2 or KA3 | | Left | Right | Left | Right |
| <p>Top View</p> | KA1 | or | KA3 | KA1 #2 | 1 | 0 | 0 | 1 |
| | | | KA2 | KA2 #2 | 0 | 1 | 1 | 0 |
| | KA1 | or | KA3 | KA1 #1 | 1 | 0 | 0 | 1 |
| | | | KA2 | KA2 #1 | 0 | 1 | 1 | 0 |
| Cam (see page 47) | | | | | E | D | | |

Non-Illuminated Operators

| Manual Return (1), Operator Only (without contact blocks) | Reference | Reference |
|---|------------------|------------------|
| Without Knob | SKS11 | SKS12 |
| With Knob (3) | SKS11♦ | SKS12♦ |
| Operator with Contact Blocks and Standard black knob | Reference | Reference |
| With 1 KA1 on Side #2 | SKS11BH13 | — |
| With 1 KA1 on Side #1 | SKS11BH1 | — |
| With 1 KA1 on Side #1 and 1 KA1 on side #2 | SKS11BH2 | — |
| Spring Return from Left (1), Operator Only (without contact blocks) | Reference | Reference |
| Without Knob | SKS25 | — |
| With Knob (3) | SKS25♦ | — |
| Spring Return from Right (1), Operator Only (without contact blocks) | Reference | Reference |
| Without Knob | — | SKS34 |
| With Knob (3) | — | SKS34♦ |

Illuminated Operators

| Manual Return (1), Operator Only (without contact blocks) | Reference | Reference |
|---|------------------|------------------|
| Without Knob, 110-120V 50-60 Hz Transformer | SK11J1 | SK12J1 |
| With Standard Red Knob, 110-120V 50-60 Hz Transformer | SK11J1R | SK12J1R |
| With Other Color Knob and other voltage Light Module (2) (3) | SK11J■♦ | SK12J■♦ |
| Spring Return from Left (1), Operator Only (without contact blocks) | Reference | Reference |
| Without Knob, 110-120V 50-60 Hz Transformer | SK25J1 | — |
| With Standard Red Knob, 110-120V 50-60 Hz Transformer | SK25J1R | — |
| With Other Color Knob and other voltage Light Module (2) (3) | SK25J■♦ | — |
| Spring Return from Right (1), Operator Only (without contact blocks) | Reference | Reference |
| Without Knob, 110-120V 50-60 Hz Transformer | — | SK34J1 |
| With Standard Red Knob, 110-120V 50-60 Hz Transformer | — | SK34J1R |
| With Other Color Knob and other voltage Light Module (2) (3) | — | SK34J■♦ |

(1) These operators can be ordered complete with contact blocks. Add the “H code” from page 51 as needed for your application.
 (2) Replace ■ with the voltage assembly code as chosen from the tables on page 54. Example: K25J■ with 208Vac = K25J3
 (3) Replace ♦ with the color code as chosen from the color code table below. For LED, knob color must match LED.

Selector Switch Assembly Code and Knob Cat. No.

| Color | Standard Knob | | Gloved Hand Knob | |
|--------|---------------|-----------|------------------|-----------|
| | ♦ Knob Code | Reference | ♦ Knob Code | Reference |
| Black | B | B11 | FB | B25 |
| Red | R | R8 | FR | R24 |
| Green | G | G8 | FG | G24 |
| Yellow | Y | Y8 | FY | Y24 |
| Blue | L | L8 | FL | L24 |
| White | W | W8 | FW | W24 |
| Amber | A | A8 | FA | A24 |
| Clear | C | C8 | FC | C24 |

To select and order Contact Blocks, Light Modules, Knobs, and Accessories, see pages 50 to 59.

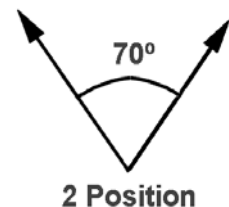

Harmony™ 9001K/SK/KX

30 mm push buttons

9001SK – Selector switches

Note: When ordering, add prefix “9001” to the reference.

3-Position Selector Switches

| Contact Block Required Contact Block Position | Quantity and Type | Mount on Side | 1 — Contact Closed | | 0 — Contact Open | | Center | | Center | | Center | | Center | |
|--|-------------------|---------------|--------------------|----------|------------------|----------|----------|----------|----------|----------|----------|--------|--------|--------|
| | | | Center | Center | Center | Center | Center | Center | Center | Center | Center | Center | Center | Center |
| <p>Top View</p> | KA1 or KA3 | KA1 or KA3 #2 | 1 | 0 | 0 | 1 | 0 | 0 | 0 | 0 | 1 | 1 | 0 | 0 |
| | KA2 | KA2 #2 | 0 | 1 | 1 | 0 | 0 | 1 | 0 | 1 | 0 | 0 | 1 | 0 |
| | KA1 or KA3 | KA1 or KA3 #1 | 0 | 0 | 1 | 1 | 0 | 0 | 0 | 1 | 0 | 0 | 1 | 1 |
| | KA2 | KA2 #1 | 1 | 1 | 0 | 0 | 0 | 1 | 0 | 1 | 0 | 0 | 1 | 0 |
| Cam (see page 47) | | | B | C | D | E | F | G | J | L | M | | | |

Non-Illuminated Operators

| Manual Return, Operator Only (without contact blocks) (1) | | | | | | | | | |
|---|-----------|-----------|-----------|-----------|-----------|-----------|-----------|------------|------------|
| Without Knob | SKS42 | SKS43 | SKS44 | SKS45 | SKS46 | SKS47 | SKS49 | SKS401 | SKS402 |
| With Knob (select style and color from table below) | SKS42♦ | SKS43♦ | SKS44♦ | SKS45♦ | SKS46♦ | SKS47♦ | SKS49♦ | SKS401♦ | SKS402♦ |
| Operator with Contact Blocks and Standard black knob (4) | | | | | | | | | |
| With 1 KA1 on Side #2 (H13) | SKS42BH13 | SKS43BH13 | SKS44BH13 | SKS45BH13 | SKS46BH13 | SKS47BH13 | SKS49BH13 | SKS401BH13 | SKS402BH13 |
| With 1 KA1 on Side #1 (H1) | SKS42BH1 | SKS43BH1 | SKS44BH1 | SKS45BH1 | SKS46BH1 | SKS47BH1 | SKS49BH1 | SKS401BH1 | SKS402BH1 |
| With 1 KA1 on Side #1 and 1 KA1 on side #2 (H2) | SKS42BH2 | SKS43BH2 | SKS44BH2 | SKS45BH2 | SKS46BH2 | SKS47BH2 | SKS49BH2 | SKS401BH2 | SKS402BH2 |
| Spring Return from Left to Center, Operator Only (without contact blocks) (1) | | | | | | | | | |
| Without Knob | SKS62 | SKS63 | SKS64 | SKS65 | SKS66 | SKS67 | SKS69 | SKS601 | SKS602 |
| With Knob (select style and color from table below) | SKS62♦ | SKS63♦ | SKS64♦ | SKS65♦ | SKS66♦ | SKS67♦ | SKS69♦ | SKS601♦ | SKS602♦ |
| Spring Return from Right to Center, Operator Only (without contact blocks) (1) | | | | | | | | | |
| Without Knob | SKS72 | SKS73 | SKS74 | SKS75 | SKS76 | SKS77 | SKS79 | SKS701 | SKS702 |
| With Knob (select style and color from table below) | SKS72♦ | SKS73♦ | SKS74♦ | SKS75♦ | SKS76♦ | SKS77♦ | SKS79♦ | SKS701♦ | SKS702♦ |
| Spring Return from Both Sides to Center, Operator Only (without contact blocks) (1) | | | | | | | | | |
| Without Knob | SKS52 | SKS53 | SKS54 | SKS55 | SKS56 | SKS57 | SKS59 | SKS501 | SKS502 |
| With Knob (select style and color from table below) | SKS52♦ | SKS53♦ | SKS54♦ | SKS55♦ | SKS56♦ | SKS57♦ | SKS59♦ | SKS501♦ | SKS502♦ |

Illuminated Operators

| Manual Return, Operator Only (without contact blocks) (1) | | | | | | | | | |
|---|---------|---------|---------|---------|---------|---------|---------|----------|----------|
| Without Knob, 110-120V 50-60 Hz Transformer | SK42J1 | SK43J1 | SK44J1 | SK45J1 | SK46J1 | SK47J1 | SK49J1 | SK401J1 | SK402J1 |
| With Standard Red Knob, 110-120V 50-60 Hz Transformer | SK42J1R | SK43J1R | SK44J1R | SK45J1R | SK46J1R | SK47J1R | SK49J1R | SK401J1R | SK402J1R |
| With Other Color Knob and other voltage Light Module (2) (3) | SK42J■♦ | SK43J■♦ | SK44J■♦ | SK45J■♦ | SK46J■♦ | SK47J■♦ | SK49J■♦ | SK401J■♦ | SK402J■♦ |
| Spring Return from Left to Center, Operator Only (without contact blocks) (1) | | | | | | | | | |
| Without Knob, 110-120V 50-60 Hz Transformer | SK62J1 | SK63J1 | SK64J1 | SK65J1 | SK66J1 | SK67J1 | SK69J1 | SK601J1 | SK602J1 |
| With Standard Red Knob, 110-120V 50-60 Hz Transformer | SK62J1R | SK63J1R | SK64J1R | SK65J1R | SK66J1R | SK67J1R | SK69J1R | SK601J1R | SK602J1R |
| With Other Color Knob and other voltage Light Module (2) (3) | SK62J■♦ | SK63J■♦ | SK64J■♦ | SK65J■♦ | SK66J■♦ | SK67J■♦ | SK69J■♦ | SK601J■♦ | SK602J■♦ |
| Spring Return from Right to Center, Operator Only (without contact blocks) (1) | | | | | | | | | |
| Without Knob, 110-120V 50-60 Hz Transformer | SK72J1 | SK73J1 | SK74J1 | SK75J1 | SK76J1 | SK77J1 | SK79J1 | SK701J1 | SK702J1 |
| With Standard Red Knob, 110-120V 50-60 Hz Transformer | SK72J1R | SK73J1R | SK74J1R | SK75J1R | SK76J1R | SK77J1R | SK79J1R | SK701J1R | SK702J1R |
| With Other Color Knob and other voltage Light Module (2) (3) | SK72J■♦ | SK73J■♦ | SK74J■♦ | SK75J■♦ | SK76J■♦ | SK77J■♦ | SK79J■♦ | SK701J■♦ | SK702J■♦ |
| Spring Return from Both Sides to Center, Operator Only (without contact blocks) (1) | | | | | | | | | |
| Without Knob, 110-120V 50-60 Hz Transformer | SK52J1 | SK53J1 | SK54J1 | SK55J1 | SK56J1 | SK57J1 | SK59J1 | SK501J1 | SK502J1 |
| With Standard Red Knob, 110-120V 50-60 Hz Transformer | SK52J1R | SK53J1R | SK54J1R | SK55J1R | SK56J1R | SK57J1R | SK59J1R | SK501J1R | SK502J1R |
| With Other Color Knob and other voltage Light Module (2) (3) | SK52J■♦ | SK53J■♦ | SK54J■♦ | SK55J■♦ | SK56J■♦ | SK57J■♦ | SK59J■♦ | SK501J■♦ | SK502J■♦ |

- ▲ These operators can be ordered complete with contact blocks. Add the “H code” from page 51 as needed for your application.
- Replace ■ with the voltage assembly code as chosen from the tables on page 54. Example: K25J■ with 208Vac = K25J3.
- ♦ Replace ♦ with the color code as chosen from the color code table below. For LED, knob color must match LED.
- ★ For other color knobs replace the B with knob color code from table below.

Selector Switch Assembly Code and Knob Cat. No.

| Color | Standard Knob | | Gloved Hand Knob | |
|--------|---------------|-----------|------------------|-----------|
| | ◆ Knob Code | Reference | ◆ Knob Code | Reference |
| Black | B | B11 | FB | B25 |
| Red | R | R8 | FR | R24 |
| Green | G | G8 | FG | G24 |
| Yellow | Y | Y8 | FY | Y24 |
| Blue | L | L8 | FL | L24 |
| White | W | W8 | FW | W24 |
| Amber | A | A8 | FA | A24 |
| Clear | C | C8 | FC | C24 |



To select and order Contact Blocks, Light Modules, Knobs, and Accessories, see pages 50 to 59.

Harmony™ 9001K/SK/KX

30 mm push buttons

9001SK – Selector switches

Note: When ordering, add prefix “9001” to the reference.

| 4-Position Selector Switches | | | | |
|-------------------------------------|-------------------|---------------|--|---------|
| Contact Block Required and Position | Quantity and Type | Mount on Side | 1 — Contact Closed 0 — Contact Open | |
| <p>Top View</p> | KA1 or KA3 | KA1 or KA3 #2 | | |
| | | KA2 | KA2 #2 | 1 0 0 0 |
| | | | | 0 0 1 0 |
| | KA1 or KA3 | KA1 or KA3 #1 | | 0 0 0 1 |
| | | KA2 #1 | | 0 1 0 0 |
| | | KA2 #1 | | |

Cam (see page 47) **H**

Non-Illuminated Operators

| Manual Return (1), Operator Only (without contact blocks) | Reference |
|---|-----------|
| Without Knob | SKS88 |
| With Knob (3) | SKS88♦ |

Illuminated Operators

| Manual Return (1), Operator Only (without contact blocks) | Reference |
|--|-----------|
| Without Knob, 110-120V 50-60 Hz Transformer | SK88J1 |
| With Standard Red Knob, 110-120V 50-60 Hz Transformer | SK88J1R |
| With Other Color Knob and other voltage Light Module (2) (3) | SK88J■♦ |

(1) These operators can be ordered complete with contact blocks. Add the “H code” from page 51 as needed for your application.
 (2) Replace ■ with the voltage assembly code as chosen from the tables on page 54. Example: K25J■ with 208Vac = K25J3
 (3) Replace ♦ with the color code as chosen from the color code table below. For LED, knob color must match LED.

Selector Switch Assembly Code and Knob Cat. No.

| Color | Standard Knob | | Gloved Hand Knob | |
|--------|---------------|-----------|------------------|-----------|
| | ◆ Knob Code | Reference | ◆ Knob Code | Reference |
| Black | B | B11 | FB | B25 |
| Red | R | R8 | FR | R24 |
| Green | G | G8 | FG | G24 |
| Yellow | Y | Y8 | FY | Y24 |
| Blue | L | L8 | FL | L24 |
| White | W | W8 | FW | W24 |
| Amber | A | A8 | FA | A24 |
| Clear | C | C8 | FC | C24 |



Potentiometer with Dial Plate (not UL listed)—Maximum Voltage 300 Vac

| Power | Description | Ratings | Reference |
|-------|---|------------|-----------|
| 2 W | Operator Only, for Single Potentiometer | NEMA 4, 13 | SK20 |
| | Operator with Single Potentiometer | | SK21 |
| | Operator Only, for Tandem Potentiometer | | SK22 |
| | Operator with Tandem Potentiometer | | SK23 |



Potentiometer Suffixes

| Single Potentiometer | | | |
|----------------------|------------|------------|------------|
| Suffix (4) | Resistance | Suffix (4) | Resistance |
| 01 | 50 Ω | 07 | 5 kΩ |
| 02 | 100 Ω | 08 | 10 kΩ |
| 04 | 500 Ω | 09 | 25 kΩ |
| 05 | 1 kΩ | 13 | 500 kΩ |
| 39 | 2 kΩ | 37 | 750 kΩ |
| 06 | 2.5 kΩ | 14 | 1 MΩ |

| Tandem Potentiometer | | |
|----------------------|------------|------|
| Suffix (4) | Resistance | |
| | Front | Rear |
| 82 | 1 kΩ | 1 kΩ |

(4) For the complete reference, add the suffix from Suffix column to the reference from Reference column in “Potentiometer with Dial Plate” table above. Example: 9001 SK21 05.
 Note: Any potentiometer with a shaft 7/8" long and 1/4" diameter may be used with these operators
 Note: To select and order Contact Blocks, Light Modules, Knobs, and Accessories, see pages 50 to 59.

Harmony™ 9001K/SK/KX

30 mm push buttons

9001SK – Selector switch guide

Note: When ordering, add prefix “9001” to the reference.

Shown below is a simplified method of selecting a selector switch to meet almost any combination of contact sequences.

Step No. 1

Determine the contact sequence(s) required. Set up a target table like the one shown for the example below.

| Contact Sequence | 0—contact open | 1—contact closed | | | |
|------------------|----------------|------------------|---|---|--|
| A | | 1 | 0 | 0 | |
| B | | 0 | 1 | 0 | |
| C | | 0 | 0 | 1 | |

Step No. 2

Look for a cam type common to all sequences in the three tables to the right. For the example above, the “3-Position Selector Switch” table would be used. For the contact sequences A (1 0 0), B (0 1 0) and C (0 0 1) of the example above, cam types F and L are common to all three sequences.

Step No. 3

Next, use the cam type common to all the sequences (if several cam types are common, choose one) to find the operator reference number. Go to the proper page number as indicated in the table below:

| Number of Positions | Push Button Line | Page Number |
|---------------------|------------------|-------------|
| 2 | 9001SKS | 44 |
| 3 | 9001SKS | 45 |
| 4 | 9001SKS | 46 |

If for the example above a manual return operator with a standard black knob is required and:

The F cam type is chosen, the operator reference number is:

- 9001SK—9001SKS46B (from page 45)

The L cam type is chosen, the operator reference number is:

- 9001SK—9001SKS401B (from page 45)

Step No. 4

Determine the contact blocks required by using the same table in Step No. 2.

If, for the example above, the F cam type is chosen:

- Use a 9001KA3 mounted on side no. 2 for sequence A (1 0 0).
- Use a 9001KA3 mounted on side no. 1 for sequence B (0 1 0).
- Use a 9001KA2 mounted on side no. 1 or 2 for sequence C (0 0 1).

If, for the example above, the L cam type is chosen:

- Use a 9001KA2 mounted on side no. 2 for sequence A (1 0 0).
- Use a 9001KA2 mounted on side no. 1 or a 9001KA3 mounted on side no. 2 for sequence B (0 1 0).
- Use a 9001KA3 mounted on side no. 1 for sequence C (0 0 1).

One 9001KA1 double circuit block can be used in place of one 9001KA2 single circuit block plus one 9001KA3 single circuit block mounted on the same side.

2-Position Selector Switch

| If you require contact sequence— | Use Cam Type | Use Contact Block Reference | Mount on side no. (See page 51) |
|----------------------------------|--------------|-----------------------------|---------------------------------|
| 1 0 | E | KA3 | 1 or 2 |
| | D | KA2 | 1 or 2 |
| 0 1 | E | KA2 | 1 or 2 |
| | D | KA3 | 1 or 2 |

3-Position Selector Switch

| If you require contact sequence— | Use Cam Type | Use Contact Block Reference | Mount on side no. (See page 51) |
|----------------------------------|--------------|-----------------------------|---------------------------------|
| 1 0 0 | G M | KA2 | 1 |
| | L | KA2 | 2 |
| | C E | KA3 | 1 |
| | B C E F G J | KA3 | 2 |
| | B G J | KA5 (1) | 2 |
| 0 1 0 | D E J L | KA2 | 1 |
| | D E | KA2 | 2 |
| | F | KA3 | 1 |
| | L | KA3 | 2 |
| 0 0 1 | C F | KA2 | 1 or 2 |
| | B D G L | KA3 | 1 |
| | D | KA3 | 2 |
| | B | KA5 (1) | 1 |
| | M | KA2 | 2 |
| 1 1 0 | C F | KA5 (1) | 1 or 2 |
| | M | KA3 | 2 |
| 0 1 1 | B G J L | KA2 | 2 |
| | G | KA5 (1) | 1 |
| | L | KA5 (1) | 2 |
| | M | KA3 | 1 |
| 1 0 1 | J L | KA3 | 1 |
| | D E J L | KA5 (1) | 1 |
| | D E | KA5 (1) | 2 |

4-Position Selector Switch

| If you require contact sequence— | Use Cam Type | Use Contact Block Reference | Mount on side no. (See page 51) |
|----------------------------------|--------------|-----------------------------|---------------------------------|
| 1 0 0 0 | H | (A) KA3 | 2 |
| 0 1 0 0 | H | (B) KA2 | 1 |
| 0 0 1 0 | H | (C) KA2 | 2 |
| 0 0 0 1 | H | (D) KA3 | 1 |
| 1 0 0 1 | H | A & D Wired in Parallel | |
| 1 1 0 0 | H | A & B Wired in Parallel | |
| 0 1 1 0 | H | B & C Wired in Parallel | |
| 0 0 1 1 | H | C & D Wired in Parallel | |
| 1 1 1 0 | H | A, B & C Wired in Parallel | |
| 0 1 1 1 | H | B, C & D Wired in Parallel | |
| 1 0 1 0 | H | A & C Wired in Parallel | |
| 0 1 0 1 | H | B & D Wired in Parallel | |
| 1 1 0 1 | H | KA5 (1) | 2 |
| 1 0 1 1 | H | KA5 (1) | 1 |

(1) 9001KA5 must be the last block on either side.



When ordering, please specify:

- Quantity
- Class Number
- Type or Reference

For “H” Numbers, see page 51.

Harmony™ 9001K/SK/KX

30 mm push buttons

9001SK – Pilot lights

Note: When ordering, add prefix “9001” to the reference.

Pilot Lights—UL Types 4, 4X, 13/NEMA 4, 4X, 13
For use in hazardous locations, see page 53. Legend plate not included.

| Description | Voltage | Style | With Red Fresnel Color Cap | With Green Fresnel Color Cap | With Other Color Cap (2) | Without Color Cap |
|---|---------------------------------|--|----------------------------|------------------------------|--------------------------|-------------------|
|  Standard Pilot Light (Fresnel color cap shown) | 110–120 V, 50–60 Hz Transformer | Transformer | SKP1R31 | SKP1G31 | SKP1■ | SKP1 |
| | 220–240 V, 50–60 Hz Transformer | Transformer | SKP7R31 | SKP7G31 | SKP7■ | SKP7 |
| | 24–28 Vac/Vdc | Full Voltage | SKP35R31 | SKP35G31 | SKP35■ | SKP35 |
| | For other voltages (1) | Transformer, Flashing or LED (3) | SKP▲R31 | SKP▲G31 | SKP▲■ | SKP▲ |
|  Push-To-Test Pilot Light (Fresnel color cap shown) | 110–120 V, 50–60 Hz Transformer | Transformer | SKT1R31 | SKT1G31 | SKT1■ | SKT1 |
| | 220–240 V, 50–60 Hz Transformer | Transformer | SKT7R31 | SKT7G31 | SKT7■ | SKT7 |
| | 24–28 Vac/Vdc | Full Voltage | SKT35R31 | SKT35G31 | SKT35■ | SKT35 |
| | For other voltages (1) | 92% Full Voltage, Neon or Resistor (4) | SKT▲R31 | SKT▲G31 | SKT▲■ | SKT▲ |
|  Remote Test Pilot Light (Fresnel color cap shown) | 120 Vac Only | Resistor | SKTR38R31 | SKTR38G31 | SKTR38■ | SKTR38 |
| | 24–28 Vac Only | Full Voltage | SKTR35R31 | SKTR35G31 | SKTR35■ | SKTR35 |
| | For other voltages (1) | Full Voltage or Resistor (5) | SKTR▲R31 | SKTR▲G31 | SKTR▲■ | SKTR▲ |
| | | | | | | |

- (1) Replace ▲ with the voltage assembly code as chosen from the tables on page 54. Example: SKT▲R31 with 208 Vac red LED voltage = SKT37LRR31.
- (2) Replace ■ with the color code as chosen from the color code table below. Example: SKP1■ with a blue fresnel cap = SKP1L31.
- (3) The cap must be the same color as the LED light module chosen, e.g., for a green LED, use a green color cap.
- (4) On neon light modules, use clear color caps only.
- (5) Use only full voltage or resistor voltage assembly codes on remote test pilot lights. Do not choose LED, neon or transformer codes. For AC use only.

Color Caps

| Color | ■ Plastic Fresnel | ■ Plastic Domed |
|--------|-------------------|-----------------|
| Amber | A31 | A9 |
| Blue | L31 | L9 |
| Clear | C31 | C9 |
| Green | G31 | G9 |
| Red | R31 | R9 |
| White | W31 | W9 |
| Yellow | Y31 | Y9 |

Typical Wiring Diagrams



Push-to-test Pilot Light

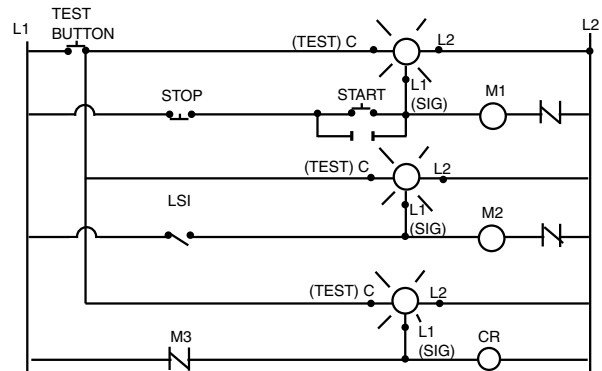

Remote Test Pilot Light

To select and order Contact Blocks, Light Modules, Knobs, and Accessories, see pages 50 to 59.

Harmony™ 9001K/SK/KX

30 mm push buttons

9001SK – Specialty operators

Note: When ordering, add prefix “9001” to the reference.

Specialty Operators—UL Types 4, 4X, 13/NEMA 4, 4X, 13

For use in hazardous locations, see page 53.

Legend plate and contact blocks not included unless otherwise noted.

| Interlocked Assembly | Description | Color | Contacts | Without Contacts |
|---|---|----------------------------|------------------------------------|--------------------------------|
|  | Interlocked Assembly Both Buttons Maintained | Universal (1) Other (2) | SKR11UH1 SKR11■H1 | SKR11U SKR11■ |
| | Interlocked Assembly One Button Momentary | Universal (1) | SKR12UH1H1 | SKR12U |
| | Interlocked Assembly One Button Maintained | Other (2) | SKR12■H1H1 | SKR12■ |

9001SKR11U

(1) Universal for SKR11, 12 includes 2 each of black, red, green, yellow, orange, blue, white.

(2) Replace ■ with the color code as chosen from the following: B = black, R = red, G = green, L = blue, Y = yellow, W = white, S = orange, E = gray.
Example: An SKR11 with top button gray and bottom button orange = SKR11ES

Harmony™ 9001K/SK/KX

30 mm push buttons

9001SK – Contact blocks

Note: When ordering, add prefix “9001” to the reference.

The 9001KA contact blocks are Fingersafe™ contact blocks (meeting VDE 0106 Part 100 Standard). They have one screw mounting and captive (backed out) plus/minus terminal screws. These contact blocks are double-break, direct-acting contacts. Because of the wiping action of these contacts, they are suitable for use with programmable controllers. All contact blocks listed below accept up to 2 #12–#24 AWG solid or stranded wires. Recommended tightening torque for screw terminals is 7 lb-in.

Standard Contact Blocks

| Description | Symbol | Reference |
|---------------|--------------------------------|------------|
| (Clear Cover) | Direct-Acting | KA1 |
| (Green Cover) | | KA2 |
| (Red Cover) | Direct-Acting | KA3 |
| (Clear Cover) | N.O. Contact Early Closing | KA4 |
| (Red Cover) | N.C. Contact Late Opening | KA5 |
| (Green Cover) | N.O. Contact Early Closing | KA6 |

Additional Circuit Arrangements

| | | |
|--|--|----------------------------------|
| Sequencing (1) N.O. Contact of KA4 closes before N.O. Contact on KA1 | | Order One9001KA4 and One 9001KA1 |
| Overlapping (1) N.O. Contact of KA4 closes before N.C. Contact of KA5 opens | | Order One9001KA4 and One 9001KA5 |

(1) For push buttons or two-position selector switches only. For sequencing or overlapping contacts on other operators, refer to catalog 9001CT0001.

| Symbol | Contact Blocks with Binder Head Screws (not Fingersafe) Reference | Quantity (2) | Gold Flashed Contacts with Standard Pressure Wire Terminals Reference |
|-------------------------------|---|--------------|---|
| | KA21 | 25–Up | KA31 |
| | KA22 | 25–Up | KA32 |
| | KA23 | 25–Up | KA33 |
| N.O. Early Closing | KA24 | 25–Up | KA34 |
| N.C. Contact Late Opening | KA25 | 25–Up | KA35 |

(2) Minimum order quantity is 25.

Contact blocks listed below are not Fingersafe, but provide:

- Terminals that accept ring tongue/fork tongue connectors
- Short single circuit contact blocks (0.75” deep vs. 0.97” deep on the Fingersafe)
- For assembled operators, use form Y238 (add to reference as suffix, for example: 9001KRU1H13Y238)



Contact blocks (not Fingersafe)

| Symbol | Reference | Symbol | Reference |
|--------|-------------|--------------------------------|-------------|
| | KA1G | N.O. Contact Early Closing | KA4G |
| | KA2G | N.C. Contact Late Opening | KA5G |
| | KA3G | N.O. Contact Early Closing | KA6G |

Contact blocks with Quick-Connect terminals (not Fingersafe)

| Symbol | Reference |
|--------|-------------|
| | KA12 |
| | KA13 |

For dimensions, refer to catalog 9001CT0001

Maximum Current Ratings for Control Circuit Contacts—9001KA1–KA6, KA21–KA25, KA31–KA35, KA1G–KA6G

| V | AC | | | | | | V | DC | | | | |
|-----|--|------|---------|-----|-----------------------------|---|-----|-------------------------------------|---------|-----|-----------------------------|---------|
| | Inductive (NEMA / UL Type A600) 35% Power Factor | | | | | Resistive 75% Power Factor Make, Break and Continuous Amperes | | Inductive and Resistive (NEMA Q600) | | | | |
| | Make | | Break | | Continuous Carrying Amperes | | | Make and Break | | | Continuous Carrying Amperes | |
| | Amperes | VA | Amperes | VA | | | | KA1 | KA2 KA3 | KA4 | | KA5 KA6 |
| 120 | 60 | 7200 | 6.0 | 720 | 10 | 10 | 125 | 0.55 | 0.55 | — | — | 2.5 |
| 240 | 30 | | 3.0 | | | | 250 | 0.27 | 0.27 | — | — | |
| 480 | 15 | | 1.5 | | | | 600 | 0.10 | 0.10 | — | — | |
| 600 | 12 | | 1.2 | | | | | | | | | |

To select and order Contact Blocks, Light Modules, Knobs, and Accessories, see pages 50 to 59.

Harmony™ 9001K/SK/KX 30 mm push buttons 9001SK – Contact blocks

Note: When ordering, add prefix “9001” to the reference.

Contact Block “H” Codes

The design of the 9001KA contact blocks allows them to be mounted side by side and/or in tandem. This enables you to specify an operator and a particular arrangement of contact blocks (shipped completely assembled) with a single reference number. See page 50 for a description of contact blocks.



Example: A 9001KR1B push button with 2 9001KA1 contact blocks would be 9001KR1BH2.

| Suffix No. (Add to Operator Reference) | Positions | | | | | |
|--|-----------|-----|-----|-----|-----|-----|
| | 1 | 2 | 3 | 4 | 5 | 6 |
| H1 | KA1 | | | | | |
| H2 | KA1 | KA1 | | | | |
| H3 | KA1 | KA1 | KA1 | | | |
| H4 | KA1 | KA1 | KA1 | KA1 | | |
| H5 | KA2 | | | | | |
| H6 | KA3 | | | | | |
| H7 | KA2 | KA2 | | | | |
| H8 | KA3 | KA3 | | | | |
| H9 | KA4 | KA1 | | | | |
| H10 | KA4 | KA5 | | | | |
| H11 | KA1 | KA1 | | KA1 | | |
| H12 | KA2 | KA3 | KA2 | KA3 | | |
| H13 | | KA1 | | | | |
| H14 | | KA3 | | | | |
| H15 | KA2 | KA3 | KA2 | | | |
| H16 | KA2 | KA3 | | KA3 | | |
| H17 | KA1 | KA1 | KA2 | | | |
| H18 | KA3 | KA1 | KA3 | | KA3 | |
| H19 | KA1 | KA1 | KA1 | KA1 | KA1 | |
| H21 | KA2 | KA3 | | | | |
| H23 | KA1 | KA1 | KA1 | KA1 | KA1 | KA1 |
| H24 | KA1 | KA2 | | | | |
| H25 | KA5 | KA3 | | | | |

Note: For “H” Codes not shown in this table, contact your local Schneider Electric representative.

Dimensions When Using Contact Blocks



Maximum Contact Block Usage:

2 blocks mounted side by side only: Any 2, 3 or 4-Position spring return selector switch (non-illuminated, illuminated or keyed).

2 blocks mounted in tandem on one side only: Any 2 operator interlocked push button.

2 blocks mounted in tandem (total of four blocks): Any selector push button, keyed push button, 2, 3, or 4-Position maintained selector switch (non-illuminated, illuminated or keyed), push pull operators (non-illuminated or illuminated), joy stick, dual push button.

3 blocks mounted in tandem (total of six blocks): Single momentary push buttons (non-illuminated or illuminated).

Harmony™ 9001K/SK/KX

30 mm push buttons

9001SK – Contact blocks

Note: When ordering, add prefix “9001” to the reference.

Mounting Hole for All 9001SK Control Units



Hole Punch: Use Greenlee Tool #60242 to punch mounting hole and notch.

Maximum Contact Block Usage:

- **2 blocks mounted side by side only:** Any 2, 3 or 4-Position **spring return** selector switch (non-illuminated, illuminated or keyed).
- **2 blocks mounted in tandem on one side only:** Any 2 operator interlocked push button.
- **2 blocks mounted in tandem (total of four blocks):** Any selector push button, keyed push button, 2, 3, or 4-Position **maintained** selector switch (non-illuminated, illuminated or keyed), push-pull operators (non-illuminated or illuminated), joy stick, dual push button.
- **3 blocks mounted in tandem (total of six blocks):** Single momentary push buttons (non-illuminated or illuminated).



Min. Centerline Spacing, 9001SK Control Units

| Legend Plate | Operator | Centerline Spacing (in) | | | | | |
|---|------------------------|-------------------------|------|------|------|------|------|
| | | A | B | C | D | E | F |
| Legend Plate Orientation Position #1 | | | | | | | |
| KN2 | Standard Push Button | 1.75 | 1.31 | 1.44 | 2.25 | 1.69 | 0.88 |
| | 1.375 in Dia. Mushroom | 1.75 | 1.31 | 1.44 | 2.25 | 1.69 | 0.88 |
| | 2.25 in Dia. Mushroom | 2.25 | 1.31 | 1.44 | 2.25 | 2.25 | 1.12 |
| | Selector Switch Knobs | 1.75 | 1.31 | 1.44 | 2.25 | 1.69 | 0.88 |
| KN3 | Standard Push Button | 2.00 | 1.31 | 1.44 | 2.25 | 1.75 | 0.88 |
| | 1.375 in Dia. Mushroom | 2.00 | 1.31 | 1.44 | 2.25 | 1.75 | 0.88 |
| | 2.25 in Dia. Mushroom | 2.25 | 1.31 | 1.44 | 2.25 | 2.25 | 1.12 |
| | Selector Switch Knobs | 2.00 | 1.31 | 1.44 | 2.25 | 1.75 | 0.88 |
| KN4 | Standard Push Button | 1.94 | 1.31 | 1.44 | 2.25 | 1.62 | 0.88 |
| | 1.375 in Dia. Mushroom | 1.94 | 1.31 | 1.44 | 2.25 | 1.62 | 0.88 |
| | 2.25 in Dia. Mushroom | 2.25 | 1.31 | 1.44 | 2.25 | 2.25 | 1.12 |
| | Selector Switch Knobs | 1.74 | 1.31 | 1.44 | 2.25 | 1.62 | 0.88 |
| KN6 | Standard Push Button | 2.38 | 1.62 | 1.44 | 2.25 | 2.25 | 1.12 |
| | 1.375 in Dia. Mushroom | 2.38 | 1.62 | 1.44 | 2.25 | 2.25 | 1.12 |
| | 2.25 in Dia. Mushroom | 2.38 | 1.62 | 1.44 | 2.25 | 2.25 | 1.12 |
| | Selector Switch Knobs | 2.38 | 1.62 | 1.44 | 2.25 | 2.25 | 1.12 |

| Legend Plate | Operator | Centerline Spacing (in) | | | | | |
|---|------------------------|-------------------------|------|------|------|------|------|
| | | A | B | C | D | E | F |
| Legend Plate Orientation Position #2 | | | | | | | |
| KN2 | Standard Push Button | 1.62 | 1.31 | 1.44 | 2.25 | 1.75 | 0.88 |
| | 1.375 in Dia. Mushroom | 1.62 | 1.31 | 1.44 | 2.25 | 1.75 | 0.88 |
| | 2.25 in Dia. Mushroom | 2.25 | 1.31 | 1.44 | 2.25 | 2.25 | 1.12 |
| | Selector Switch Knobs | 1.62 | 1.31 | 1.44 | 2.25 | 1.75 | 0.88 |
| KN3 | Standard Push Button | 1.75 | 1.31 | 1.44 | 2.25 | 2.00 | 0.88 |
| | 1.375 in Dia. Mushroom | 1.75 | 1.31 | 1.44 | 2.25 | 2.00 | 0.88 |
| | 2.25 in Dia. Mushroom | 2.25 | 1.31 | 1.44 | 2.25 | 2.25 | 1.12 |
| | Selector Switch Knobs | 1.75 | 1.31 | 1.44 | 2.25 | 2.00 | 0.88 |
| KN4 | Standard Push Button | 1.62 | 1.31 | 1.44 | 2.25 | 1.94 | 1.00 |
| | 1.375 in Dia. Mushroom | 1.62 | 1.31 | 1.44 | 2.25 | 1.94 | 1.00 |
| | 2.25 in Dia. Mushroom | 2.25 | 1.31 | 1.44 | 2.25 | 2.25 | 1.12 |
| | Selector Switch Knobs | 1.62 | 1.31 | 1.44 | 2.25 | 1.94 | 1.00 |
| KN6 | Standard Push Button | 2.25 | 1.31 | 1.62 | 2.38 | 2.38 | 0.88 |
| | 1.375 in Dia. Mushroom | 2.25 | 1.31 | 1.62 | 2.38 | 2.38 | 0.88 |
| | 2.25 in Dia. Mushroom | 2.25 | 1.31 | 1.62 | 2.38 | 2.38 | 1.12 |
| | Selector Switch Knobs | 2.25 | 1.31 | 1.62 | 2.38 | 2.38 | 0.88 |

Harmony™ 9001K/SK/KX

30 mm push buttons

9001SK – Contact blocks

Note: When ordering, add prefix “9001” to the reference.

Hazardous locations do not always require the use of explosion-proof equipment like the 9001BR control stations. Selecting the most appropriate device for the location can save you money. For more information on the types of hazardous locations, contact your local electrical inspector.

Schneider Electric Offering According to Class, Division, and Group

| For Class | Division | Group(s) | Use |
|-----------|----------|----------|---|
| I | 1 | A | 1. Intrinsically Safe System |
| I | 1 | B, C, D | 1. 9001BR station 2. Intrinsically Safe System |
| I | 2 | A | 1. 9001SK control stations with restrictions (1) 2. Intrinsically Safe System |
| I | 2 | B, C, D | 1. 9001BR station 2. 9001SK control stations with restrictions (1) 3. Intrinsically Safe System |
| II | 1 | E, F, G | 1. 9001BR station 2. Intrinsically Safe System |
| II | 2 | E, F | 1. 9001BR station 2. 9001SK control stations with restrictions (1) 3. Intrinsically Safe System |
| II | 2 | G | 1. 9001BR station 2. 9001SK control stations with restrictions (2) 3. Intrinsically Safe System |
| III | 1, 2 | — | 1. 9001BR Station 2. 9001SK control stations with restrictions (2) 3. Intrinsically Safe System |

Any 9001SK operator can be used in an area classified as Class I, Division 2 hazardous locations, if:

- Only logic (KA40 series) or power (KA50 series) reed contact blocks are used.
- All 9001SK illuminated operators are UL approved for use in Class I Division 2 areas.
- The operators are mounted in any NEMA 4 & 13 enclosures.

(1) Any 9001SK operator mounted in a 9001KY, 9001KYSS, 9001KYAF or 9001SKY enclosure may be used, except potentiometer operators.

(2) Add Form Y243 to single lamp Push-To-Test pilot lights.

Note: For (1) and (2): UL Listed: File E10054(N), CCN NOIV.

Hazardous Locations:



File E10054(N)
CCN NOIV



File Class LR26817
3218 02

Hermetically Sealed Logic Reed Contact Blocks Suitable for use on low energy level circuits

| Description | Symbol | Reference |
|-------------|--------|-----------|
| | | KA41 |
| | | KA42 |
| | | KA43 |
| | | KA44 |
| | | KA45 |

| Max. Vac/Vdc | Maximum Load | | |
|--------------|--------------|-----------|------------|
| | Resistive | Inductive | Continuous |
| 32/30 | .25 A | .10 A | .5 A |
| 120/100 | 8 VA | 3 VA | .5 A |

The maximum number of logic and/or power reed contact blocks per operator is as indicated on individual selection tables for standard contact blocks, **except**:

- On 3-Position selector switches with cams C, D, E, F, G, L, or M, mount reed blocks on **one side only** (either side), maximum 2 in tandem.
- On 4-Position selector switches, mount reed blocks on **one side only** (either side), maximum 2 in tandem.
- On joysticks or on 9001SKR8 push-pull operators, mount reed blocks on **one side only** (either side), maximum 2 in tandem.

Hermetically Sealed Power Reed Contact Blocks (5)

| Description | Symbol | Reference |
|-------------|--------|-----------|
| | | KA51 |
| | | KA52 |
| | | KA53 |
| | | KA54 |
| | | KA55 |

| Volts | AC NEMA C300 (3) | | | | Continuous Carrying Amperes |
|-------|------------------|------|-------|-----|-----------------------------|
| | Make | | Break | | |
| | A | VA | A | VA | |
| 120 | 10.00 | 1200 | 1.000 | 120 | 3.0 |
| 240 | 5.00 | | .500 | | |

| Volts | DC NEMA Q150 (4) | | | | Continuous Carrying Amperes |
|-------|------------------|----|-------|----|-----------------------------|
| | Make | | Break | | |
| | A | VA | A | VA | |
| 115 | .50 | 58 | .50 | 58 | 3.0 |

Note: All contact blocks listed above accept #12–18 solid or stranded wire.

The power reed contact blocks can be used with standard industrial relays and starters through NEMA Size 4. Minimum voltage is 5 V and the minimum current is 1 mA.

(3) Inductive Rating—35% Power Factor.

(4) Inductive and Resistive Ratings

(5) Not for use in pendant stations.

Harmony™ 9001K/SK/KX

30 mm push buttons

9001SK – Light modules

Note: When ordering, add prefix “9001” to the reference.



Standard Light Modules for 9001SK Control Units (1)

| Voltage | Description | Light Module Reference | Voltage Assembly Code | Rating | Replacement Lamp Reference |
|---------------------|--|------------------------|-----------------------|--------|----------------------------|
| All | Full Voltage (without Bayonet Base Lamp) | KM40 | 40 | — | no lamp included |
| 6 Vac/Vdc | Full Voltage | KM31 | 31 | .9 VA | 2550101020 |
| 6 Vac/Vdc | LED Red | KM31LR | 31LR | | 6508805201 |
| 6 Vac/Vdc | LED Green | KM31LG | 31LG | | 6508805203 |
| 6 Vac/Vdc | LED Yellow | KM31LY | 31LY | | 6508805202 |
| 12–14 Vac/Vdc | Full Voltage | KM32 | 32 | 1.2 VA | 2550101037 |
| 12–14 Vac/Vdc | LED Red | KM32LR | 32LR | | 6508805201 |
| 12–14 Vac/Vdc | LED Green | KM32LG | 32LG | | 6508805203 |
| 12–14 Vac/Vdc | LED Yellow | KM32LY | 32LY | | 6508805202 |
| 18 Vac/Vdc | Resistor | KM33 | 33 | 1.4 VA | 2550101037 |
| 24–28 Vac/Vdc | Full Voltage | KM35 | 35 | 1.2 VA | 2550101002 |
| 24–28 Vac/Vdc | LED Red | KM35LR | 35LR | .28 VA | 6508805210 |
| 24–28 Vac/Vdc | LED Green | KM35LG | 35LG | .28 VA | 6508805212 |
| 24–28 Vac/Vdc | LED Yellow | KM35LY | 35LY | .28 VA | 6508805211 |
| 24–28 Vac/Vdc | LED White | KM35LW | 35LW | .28 VA | 6508805214 |
| 24–28 Vac/Vdc | LED Blue | KM35LL | 35LL | .28 VA | 6508805213 |
| 48 Vac/Vdc | Full Voltage | KM36 | 36 | 2.6 VA | 2550101025 |
| 110–120 V, 50–60 Hz | LED Red | KM1LR | 1LR | | 6508805201 |
| 110–120 V, 50–60 Hz | LED Green | KM1LG | 1LG | | 6508805203 |
| 110–120 V, 50–60 Hz | LED Yellow | KM1LY | 1LY | | 6508805202 |
| 110–120 V, 50–60 Hz | Transformer | KM1 | 1 | 2.4 VA | 2550101020 |
| 110–120 V, 50–60 Hz | Flashing | KMF1 | F1 | .85 VA | 2550101036 |
| 120 Vac/Vdc | Resistor | KM38 | 38 | 3.0 VA | 2550101027 |
| 120 Vac/Vdc | Full Voltage | KM38 | 38 | 3.0 VA | 2550101027 |
| 120 Vac/Vdc | Neon | KM11 | 11 | 0.2 VA | 2550101013 |
| 120 Vac/Vdc | LED Red | KM38LR | 38LR | 1.4 VA | 6508805210 |
| 120 Vac/Vdc | LED Green | KM38LG | 38LG | 1.4 VA | 6508805212 |
| 120 Vac/Vdc | LED Yellow | KM38LY | 38LY | 1.4 VA | 6508805211 |
| 120 Vac/Vdc | LED White | KM38LW | 38LW | 1.4 VA | 6508805214 |
| 120 Vac/Vdc | LED Blue | KM38LL | 38LL | 1.4 VA | 6508805213 |
| 208–220 V, 50–60 Hz | Transformer | KM3 | 3 | 2.5 VA | 2550101020 |
| 208–220 V, 50–60 Hz | LED Red | KM3LR | 3LR | | 6508805201 |
| 208–220 V, 50–60 Hz | LED Green | KM3LG | 3LG | | 6508805203 |
| 208–220 V, 50–60 Hz | LED Yellow | KM3LY | 3LY | | 6508805202 |
| 208–220 V, 50–60 Hz | LED White | KM3LW | 3LW | | 6508805215 |
| 208–220 V, 50–60 Hz | LED Blue | KM3LL | 3LL | | 6508805216 |
| 220–240 V, 50–60 Hz | Transformer | KM7 | 7 | 2.0 VA | 2550101020 |
| 220–240 V, 50–60 Hz | LED Red | KM7LR | 7LR | | 6508805201 |
| 220–240 V, 50–60 Hz | LED Green | KM7LG | 7LG | | 6508805203 |
| 220–240 V, 50–60 Hz | LED Yellow | KM7LY | 7LY | | 6508805202 |
| 220–240 V, 50–60 Hz | LED White | KM7LW | 7LW | | 6508805215 |
| 220–240 V, 50–60 Hz | LED Blue | KM7LL | 7LL | | 6508805216 |
| 240 Vac/Vdc | Resistor | KM25 | 25 | 6.0 VA | 2550101027 |
| 240 Vac/Vdc | Neon | KM12 | 12 | 0.3 VA | 2550101013 |
| 277 V, 50–60 Hz | Transformer | KM8 | 8 | 2.4 VA | 2550101020 |
| 380–480 V, 50–60 Hz | Transformer | KM5 | 5 | 2.8 VA | 2550101020 |
| 480 Vac/Vdc | Neon | KM14 | 14 | 0.5 VA | 2550101013 |
| 550–600 V, 50–60 Hz | Transformer | KM6 | 6 | 2.5 VA | 2550101020 |

(1) For use with all operators except KX and remote test pilot.

Notes: Light modules are available in other voltages, as shown above. For use in hazardous locations, see page 53. With neon type light modules, use a clear color cap only. With LED light modules, use either a clear color cap or a cap the same color as the LED.

Shallow Depth Light Modules For 9001SK Control Units (2)

| Voltage | Description | Light Module Reference | Voltage Assembly Code | Rating | Replacement Lamp Reference |
|-----------------|--------------|------------------------|-----------------------|--------|----------------------------|
| 24–28 Vac/Vdc | Full Voltage | KM55 | 55 | 1.2 VA | 2550101002 |
| | LED Red | KM55LR | 55LR | 0.5 VA | 6508805204 |
| | LED Green | KM55LG | 55LG | | 6508805206 |
| | LED Yellow | KM55LY | 55LY | | 6508805205 |
| 110–120 Vac/Vdc | Full Voltage | KM58 | 58 | 3.0 VA | 2550101027 |
| | LED Red | KM58LR | 58LR | 0.5 VA | 6508805204 |
| | LED Green | KM58LG | 58LG | | 6508805206 |
| | LED Yellow | KM58LY | 58LY | | 6508805205 |

(2) For use with all operators except KX and remote test pilot.

Notes: For use in hazardous locations, see page 53. Reduces the depth of illuminated push buttons with contact blocks by over 33%. With LED light modules, use a cap that is the same color as the LED.



File
CCN

E42259
NKCR



File
Class

LR25490
3211 03



marked

Harmony™ 9001K/SK/KX

30 mm push buttons

9001SK – Legend plates

Note: When ordering, add prefix “9001” to the reference.

| Legend Plates | | | | | | | | | | | | |
|--|---|-------------------------------|-------------------------------|--------------------------------|-------------------------------|-------------------------------|--------------------------------|-------------------------------|-------------------------------|---|---|---|
| Standard Markings | Plastic Legend Plates for use with 9001SK Operators | | | | | | | | | Aluminum Legend Plates for use with 9001K Operators | | |
| | 1-3/4" Square | | | 2-1/4" Square | | | 2-1/2" Square | | | Black Legend | Black Legend | Blue Legend |
| | Silver Legend w/ Black Letters | White Legend w/ Black Letters | Black Legend w/ White Letters | Silver Legend w/ Black Letters | White Legend w/ Black Letters | Black Legend w/ White Letters | Silver Legend w/ Black Letters | White Legend w/ Black Letters | Black Legend w/ White Letters |  |  |  |
| For Push Button or Pilot Light | | | | | | | | | | | | |
| Blank | KN200SP | KN200WP | KN200BP | KN100SP | KN100WP | KN100BP | KN700SP | KN700WP | KN700BP | KN200 | KN300 | KN800 |
| Blank (red) | KN200RP (2) | KN200RP (2) | KN200RP (2) | KN100RP (2) | KN100RP (2) | KN100RP (2) | KN700RP (2) | KN700RP (2) | KN700RP (2) | KN200R (1) | KN300R (1) | KN800R (1) |
| Start | KN201SP | KN201WP | KN201BP | KN101SP | KN101WP | KN101BP | KN701SP | KN701WP | KN701BP | KN201 | KN301 | KN801 |
| Stop | KN202RP (2) | KN202RP (2) | KN202RP (2) | KN102RP (2) | KN102RP (2) | KN102RP (2) | KN702RP (2) | KN702RP (2) | KN702RP (2) | KN202 (1) | KN302 (1) | KN802 (1) |
| On | KN203SP | KN203WP | KN203BP | KN103SP | KN103WP | KN103BP | KN703SP | KN703WP | KN703BP | KN203 | KN303 | KN803 |
| Off | KN204RP (2) | KN204RP (2) | KN204RP (2) | KN104RP (2) | KN104RP (2) | KN104RP (2) | KN704RP (2) | KN704RP (2) | KN704RP (2) | KN204 (1) | KN304 (1) | KN804 (1) |
| Emerg. Stop | KN205RP (2) | KN205RP (2) | KN205RP (2) | KN105RP (2) | KN105RP (2) | KN105RP (2) | KN705RP (2) | KN705RP (2) | KN705RP (2) | KN205 (1) | KN305 (1) | KN805 (1) |
| Forward | KN206SP | KN206WP | KN206BP | KN106SP | KN106WP | KN106BP | KN706SP | KN706WP | KN706BP | KN206 | KN306 | KN806 |
| Reverse | KN207SP | KN207WP | KN207BP | KN107SP | KN107WP | KN107BP | KN707SP | KN707WP | KN707BP | KN207 | KN307 | KN807 |
| Close | KN208SP | KN208WP | KN208BP | KN108SP | KN108WP | KN108BP | KN708SP | KN708WP | KN708BP | KN208 | KN308 | KN808 |
| Open | KN209SP | KN209WP | KN209BP | KN109SP | KN109WP | KN109BP | KN709SP | KN709WP | KN709BP | KN209 | KN309 | KN809 |
| Down | KN210SP | KN210WP | KN210BP | KN110SP | KN110WP | KN110BP | KN710SP | KN710WP | KN710BP | KN210 | KN310 | KN810 |
| Up | KN211SP | KN211WP | KN211BP | KN111SP | KN111WP | KN111BP | KN711SP | KN711WP | KN711BP | KN211 | KN311 | KN811 |
| Fast | KN212SP | KN212WP | KN212BP | KN112SP | KN112WP | KN112BP | KN712SP | KN712WP | KN712BP | KN212 | KN312 | KN812 |
| Slow | KN213SP | KN213WP | KN213BP | KN113SP | KN113WP | KN113BP | KN713SP | KN713WP | KN713BP | KN213 | KN313 | KN813 |
| High | KN214SP | KN214WP | KN214BP | KN114SP | KN114WP | KN114BP | KN714SP | KN714WP | KN714BP | KN214 | KN314 | KN814 |
| Low | KN215SP | KN215WP | KN215BP | KN115SP | KN115WP | KN115BP | KN715SP | KN715WP | KN715BP | KN215 | KN315 | KN815 |
| Inch | KN216SP | KN216WP | KN216BP | KN116SP | KN116WP | KN116BP | KN716SP | KN716WP | KN716BP | KN216 | KN316 | KN816 |
| In | KN217SP | KN217WP | KN217BP | KN117SP | KN117WP | KN117BP | KN717SP | KN717WP | KN717BP | KN217 | KN317 | KN817 |
| Jog | KN218SP | KN218WP | KN218BP | KN118SP | KN118WP | KN118BP | KN718SP | KN718WP | KN718BP | KN218 | KN318 | KN818 |
| Jog For. | KN219SP | KN219WP | KN219BP | KN119SP | KN119WP | KN119BP | KN719SP | KN719WP | KN719BP | KN219 | KN319 | KN819 |
| Jog Rev. | KN220SP | KN220WP | KN220BP | KN120SP | KN120WP | KN120BP | KN720SP | KN720WP | KN720BP | KN220 | KN320 | KN820 |
| Lower | KN221SP | KN221WP | KN221BP | KN121SP | KN121WP | KN121BP | KN721SP | KN721WP | KN721BP | KN221 | KN321 | KN821 |
| Out | KN222SP | KN222WP | KN222BP | KN122SP | KN122WP | KN122BP | KN722SP | KN722WP | KN722BP | KN222 | KN322 | KN822 |
| Reset | KN223SP | KN223WP | KN223BP | KN123SP | KN123WP | KN123BP | KN723SP | KN723WP | KN723BP | KN223 | KN323 | KN823 |
| Run | KN224SP | KN224WP | KN224BP | KN124SP | KN124WP | KN124BP | KN724SP | KN724WP | KN724BP | KN224 | KN324 | KN824 |
| Start Jog | KN225SP | KN225WP | KN225BP | KN125SP | KN125WP | KN125BP | KN725SP | KN725WP | KN725BP | KN225 | KN325 | KN825 |
| Test | KN226SP | KN226WP | KN226BP | KN126SP | KN126WP | KN126BP | KN726SP | KN726WP | KN726BP | KN226 | KN326 | KN826 |
| Raise | KN227SP | KN227WP | KN227BP | KN127SP | KN127WP | KN127BP | KN727SP | KN727WP | KN727BP | KN227 | KN327 | KN827 |
| Decrease | KN228SP | KN228WP | KN228BP | KN128SP | KN128WP | KN128BP | KN728SP | KN728WP | KN728BP | KN228 | KN328 | KN828 |
| Increase | KN229SP | KN229WP | KN229BP | KN129SP | KN129WP | KN129BP | KN729SP | KN729WP | KN729BP | KN229 | KN329 | KN829 |
| Left | KN230SP | KN230WP | KN230BP | KN130SP | KN130WP | KN130BP | KN730SP | KN730WP | KN730BP | KN230 | KN330 | KN830 |
| Right | KN231SP | KN231WP | KN231BP | KN131SP | KN131WP | KN131BP | KN731SP | KN731WP | KN731BP | KN231 | KN331 | KN831 |
| Cycle Start | KN232SP | KN232WP | KN232BP | KN132SP | KN132WP | KN132BP | KN732SP | KN732WP | KN732BP | KN232 | KN332 | KN832 |
| Feed Start | KN233SP | KN233WP | KN233BP | KN133SP | KN133WP | KN133BP | KN733SP | KN733WP | KN733BP | KN233 | KN333 | KN833 |
| Cycle Stop | KN234SP | KN234WP | KN234BP | KN134SP | KN134WP | KN134BP | KN734SP | KN734WP | KN734BP | KN234 | KN334 | KN834 |
| Motor Run | KN236SP | KN236WP | KN236BP | KN136SP | KN136WP | KN136BP | KN736SP | KN736WP | KN736BP | KN236 | KN336 | KN836 |
| Motor Stop | KN237SP | KN237WP | KN237BP | KN137SP | KN137WP | KN137BP | KN737SP | KN737WP | KN737BP | KN237 | KN337 | KN837 |
| Power On | KN238SP | KN238WP | KN238BP | KN138SP | KN138WP | KN138BP | KN738SP | KN738WP | KN738BP | KN238 | KN338 | KN838 |
| Pull To Start | N/A | N/A | N/A | KN179SP | KN179WP | KN179BP | KN779SP | KN779WP | KN779BP | N/A | KN379 | N/A |
| Push To Stop | | | | | | | | | | | | |
| For Selector Switch or Selector Push Button | | | | | | | | | | | | |
| For.-Rev. | KN239SP | KN239WP | KN239BP | KN139SP | KN139WP | KN139BP | KN739SP | KN739WP | KN739BP | KN239 | KN339 | KN839 |
| Hand-Auto. | KN240SP | KN240WP | KN240BP | KN140SP | KN140WP | KN140BP | KN740SP | KN740WP | KN740BP | KN240 | KN340 | KN840 |
| High-Low | KN241SP | KN241WP | KN241BP | KN141SP | KN141WP | KN141BP | KN741SP | KN741WP | KN741BP | KN241 | KN341 | KN841 |
| Jog-Run | KN242SP | KN242WP | KN242BP | KN142SP | KN142WP | KN142BP | KN742SP | KN742WP | KN742BP | KN242 | KN342 | KN842 |
| Man.-Auto. | KN243SP | KN243WP | KN243BP | KN143SP | KN143WP | KN143BP | KN743SP | KN743WP | KN743BP | KN243 | KN343 | KN843 |
| Off-On | KN244SP | KN244WP | KN244BP | KN144SP | KN144WP | KN144BP | KN744SP | KN744WP | KN744BP | KN244 | KN344 | KN844 |
| On-Off | KN245SP | KN245WP | KN245BP | KN145SP | KN145WP | KN145BP | KN745SP | KN745WP | KN745BP | KN245 | KN345 | KN845 |
| Open-Close | KN246SP | KN246WP | KN246BP | KN146SP | KN146WP | KN146BP | KN746SP | KN746WP | KN746BP | KN246 | KN346 | KN846 |
| Raise-Lower | KN247SP | KN247WP | KN247BP | KN147SP | KN147WP | KN147BP | KN747SP | KN747WP | KN747BP | KN247 | KN347 | KN847 |
| Run-Jog | KN248SP | KN248WP | KN248BP | KN148SP | KN148WP | KN148BP | KN748SP | KN748WP | KN748BP | KN248 | KN348 | KN848 |
| Slow-Fast | KN250SP | KN250WP | KN250BP | KN150SP | KN150WP | KN150BP | KN750SP | KN750WP | KN750BP | KN250 | KN350 | KN850 |
| Start-Stop | KN251SP | KN251WP | KN251BP | KN151SP | KN151WP | KN151BP | KN751SP | KN751WP | KN751BP | KN251 | KN351 | KN851 |
| Up-Down | KN253SP | KN253WP | KN253BP | KN153SP | KN153WP | KN153BP | KN753SP | KN753WP | KN753BP | KN253 | KN353 | KN853 |
| Low-High | KN254SP | KN254WP | KN254BP | KN154SP | KN154WP | KN154BP | KN754SP | KN754WP | KN754BP | KN254 | KN354 | KN854 |
| Stop-Start | KN255SP | KN255WP | KN255BP | KN155SP | KN155WP | KN155BP | KN755SP | KN755WP | KN755BP | KN255 | KN355 | KN855 |
| Left-Right | KN256SP | KN256WP | KN256BP | KN156SP | KN156WP | KN156BP | KN756SP | KN756WP | KN756BP | KN256 | KN356 | KN856 |
| On-Auto | KN276SP | KN276WP | KN276BP | KN176SP | KN176WP | KN176BP | KN776SP | KN776WP | KN776BP | KN276 | KN376 | KN876 |
| Auto-Off-Hand | KN258SP | KN258WP | KN258BP | KN158SP | KN158WP | KN158BP | KN758SP | KN758WP | KN758BP | KN258 | KN358 | KN858 |
| For.-Off-Rev. | KN259SP | KN259WP | KN259BP | KN159SP | KN159WP | KN159BP | KN759SP | KN759WP | KN759BP | KN259 | KN359 | KN859 |
| Hand-Off-Auto. | KN260SP | KN260WP | KN260BP | KN160SP | KN160WP | KN160BP | KN760SP | KN760WP | KN760BP | KN260 | KN360 | KN860 |
| Man.-Off-Auto. | KN262SP | KN262WP | KN262BP | KN162SP | KN162WP | KN162BP | KN762SP | KN762WP | KN762BP | KN262 | KN362 | KN862 |
| Open-Off-Close | KN263SP | KN263WP | KN263BP | KN163SP | KN163WP | KN163BP | KN763SP | KN763WP | KN763BP | KN263 | KN363 | KN863 |
| Up-Off-Down | KN264SP | KN264WP | KN264BP | KN164SP | KN164WP | KN164BP | KN764SP | KN764WP | KN764BP | KN264 | KN364 | KN864 |
| Low-Off-High | KN265SP | KN265WP | KN265BP | KN165SP | KN165WP | KN165BP | KN765SP | KN765WP | KN765BP | KN265 | KN365 | KN865 |
| Jog-Stop-Run | KN267SP | KN267WP | KN267BP | KN167SP | KN167WP | KN167BP | KN767SP | KN767WP | KN767BP | KN267 | KN367 | KN867 |
| High-Low-Off | KN270SP | KN270WP | KN270BP | KN170SP | KN170WP | KN170BP | KN770SP | KN770WP | KN770BP | KN270 | KN370 | KN870 |
| High-Off-Low | KN277SP | KN277WP | KN277BP | KN177SP | KN177WP | KN177BP | KN777SP | KN777WP | KN777BP | KN277 | KN377 | KN877 |
| Auto-Man.-Off | KN278SP | KN278WP | KN278BP | KN178SP | KN178WP | KN178BP | KN778SP | KN778WP | KN778BP | KN278 | KN378 | KN878 |

(1) Legend plate has red background with silver letters.
 (2) Legend plate has red background with black letters.

Harmony™ 9001K/SK/KX

30 mm push buttons

9001SK – Legend plates

Note: When ordering, add prefix “9001” to the reference.

| Legend Plates—Special Marking | | | |
|--|-------------------|-----------------------------|---------|
| Legend Plate | Description | Reference | |
| KN100●P (Plastic) (1) 2.25 in Square | Standard Markings | See page 55 | |
| | Special Marking | Silver Field, Black Letters | KN199SP |
| | | White Field, Black Letters | KN199WP |
| | | Red Field, Black Letters | KN199RP |
| | | Black Field, White Letters | KN199BP |
| KN200 Aluminum | Standard Markings | See page 55 | |
| | Special Marking | Black Field | KN299 |
| Red Field | | KN299R | |
| KN200●P (Plastic) (1) 1.7 in Square | Standard Markings | See page 55 | |
| | Special Marking | Silver Field, Black Letters | KN299SP |
| | | White Field, Black Letters | KN299WP |
| | | Red Field, Black Letters | KN299RP |
| | | Black Field, White Letters | KN299BP |
| KN300 Aluminum | Standard Markings | See page 55 | |
| | Special Marking | Black Field | KN399 |
| Red Field | | KN399R | |
| KN400 Aluminum | Blank | KN400 | |
| KN500 Aluminum | Any Marking (2) | KN499 | |
| KN500 Aluminum | Standard Markings | See page 55 | |
| | Special Marking | Black Field | KN599 |
| | | Green Red Field | KN519 |
| KN600 Aluminum | Blank | Black Field | KN600 |
| | | Red Field | KN600R |
| | Any Marking (2) | Black Field | KN699 |
| | | Red Field | KN699R |
| KN700●P (Plastic) (1) 2.5 in Square | Standard Markings | Select from page 55 | |
| | Special Marking | Silver Field, Black Letters | KN799SP |
| | | White Field, Black Letters | KN799WP |
| | | Red Field, Black Letters | KN799RP |
| | | Black Field, White Letters | KN799BP |
| KN800 Aluminum | Standard Markings | Select from page 55 | |
| | Special Marking | Blue Field | KN899 |
| Red Field | | KN899R | |
| KN900 Aluminum | Blank | KN900 | |
| Aluminum | Any Marking (2) | KN999 | |

(1) Other colors available (see table below).
(2) Specify marking required.

| Plastic Legend Plates—Other Colors | | | | | |
|------------------------------------|--------------|--------------|---------------|----------------|---------------|
| | Plate Color | Letter Color | 1.7 in Square | 2.25 in Square | 2.5 in Square |
| Blank Legend Plates | Yellow | Black | KN200YP | KN100YP | KN700YP |
| | Green | White | KN200GP | KN100GP | KN700GP |
| | Blue | | KN200LP | KN100LP | KN700LP |
| | Red | | KN200CP | KN100CP | KN700CP |
| | Orange | | KN200AP | KN100AP | KN700AP |
| | Burnt Orange | Black | KN200HP | KN100HP | KN700HP |
| Special Engraved Legend Plates | Yellow | Black | KN299YP | KN199YP | KN799YP |
| | Green | White | KN299GP | KN199GP | KN799GP |
| | Blue | | KN299LP | KN199LP | KN799LP |
| | Red | | KN299CP | KN199CP | KN799CP |
| | Orange | | KN299AP | KN199AP | KN799AP |
| | Burnt Orange | Black | KN299HP | KN199HP | KN799HP |

| Maximum Number of Lines and Characters for 9001KN Legend Plates | | | | | | | | | |
|---|-------|-------|-------|-------|-----------|-------|-------|-------|----------|
| Reference | KN100 | KN200 | KN300 | KN400 | KN500 | KN600 | KN700 | KN800 | KN900 |
| Max. No. of Char. per Line | 16 | 14 | 18 | 18 | 8 | 22 | 17 | 18 | 18 |
| | | | | | per field | | | | per pos. |
| Max. No. of Lines | 2 | 1 | 3 | 2 | 2 | 4 | 2 | 2 | 1 |
| | | | | | per field | | | | per pos. |

Note: The maximum number of characters and lines is a practical maximum, based on a minimum size of characters to facilitate easy reading.

| Circular Legends for Emergency Stop Mushroom Heads (yellow background) | | |
|--|----------------|-----------|
| Diameter | Text | Reference |
| 60 mm | — | KN9100 |
| | EMERGENCY STOP | KN9330 |
| 90 mm | — | KN8100 |
| | EMERGENCY STOP | KN8330 |



Legend Plate Position #1

| Min. Centerline Spacing, 9001SK Control Units | | | | | | | |
|---|------------------------|-------------------------|------|------|------|------|------|
| Legend Plate | Operator | Centerline Spacing (in) | | | | | |
| | | A | B | C | D | E | F |
| Legend Plate Orientation Position #1 | | | | | | | |
| KN2 | Standard Push Button | 1.75 | 1.31 | 1.44 | 2.25 | 1.69 | 0.88 |
| KN5 | 1.375 in Dia. Mushroom | 1.75 | 1.31 | 1.44 | 2.25 | 1.69 | 0.88 |
| | 2.25 in Dia. Mushroom | 2.25 | 1.31 | 1.44 | 2.25 | 2.25 | 1.12 |
| | Selector Switch Knobs | 1.75 | 1.31 | 1.44 | 2.25 | 1.69 | 0.88 |
| KN3 | Standard Push Button | 2.00 | 1.31 | 1.44 | 2.25 | 1.75 | 0.88 |
| | 1.375 in Dia. Mushroom | 2.00 | 1.31 | 1.44 | 2.25 | 1.75 | 0.88 |
| | 2.25 in Dia. Mushroom | 2.25 | 1.31 | 1.44 | 2.25 | 2.25 | 1.12 |
| | Selector Switch Knobs | 2.00 | 1.31 | 1.44 | 2.25 | 1.75 | 0.88 |
| KN4 | Standard Push Button | 1.94 | 1.31 | 1.44 | 2.25 | 1.62 | 0.88 |
| | 1.375 in Dia. Mushroom | 1.94 | 1.31 | 1.44 | 2.25 | 1.62 | 0.88 |
| | 2.25 in Dia. Mushroom | 2.25 | 1.31 | 1.44 | 2.25 | 2.25 | 1.12 |
| | Selector Switch Knobs | 1.74 | 1.31 | 1.44 | 2.25 | 1.62 | 0.88 |
| KN6 | Standard Push Button | 2.38 | 1.62 | 1.44 | 2.25 | 2.25 | 1.12 |
| | 1.375 in Dia. Mushroom | 2.38 | 1.62 | 1.44 | 2.25 | 2.25 | 1.12 |
| | 2.25 in Dia. Mushroom | 2.38 | 1.62 | 1.44 | 2.25 | 2.25 | 1.12 |
| | Selector Switch Knobs | 2.38 | 1.62 | 1.44 | 2.25 | 2.25 | 1.12 |



Legend Plate Position #2

| Legend Plate Orientation Position #2 | | | | | | | |
|--------------------------------------|------------------------|------|------|------|------|------|------|
| Legend Plate | Operator | A | B | C | D | E | F |
| KN2 | Standard Push Button | 1.62 | 1.31 | 1.44 | 2.25 | 1.75 | 0.88 |
| KN5 | 1.375 in Dia. Mushroom | 1.62 | 1.31 | 1.44 | 2.25 | 1.75 | 0.88 |
| | 2.25 in Dia. Mushroom | 2.25 | 1.31 | 1.44 | 2.25 | 2.25 | 1.12 |
| | Selector Switch Knobs | 1.62 | 1.31 | 1.44 | 2.25 | 1.75 | 0.88 |
| KN3 | Standard Push Button | 1.75 | 1.31 | 1.44 | 2.25 | 2.00 | 0.88 |
| | 1.375 in Dia. Mushroom | 1.75 | 1.31 | 1.44 | 2.25 | 2.00 | 0.88 |
| | 2.25 in Dia. Mushroom | 2.25 | 1.31 | 1.44 | 2.25 | 2.25 | 1.12 |
| | Selector Switch Knobs | 1.75 | 1.31 | 1.44 | 2.25 | 2.00 | 0.88 |
| KN4 | Standard Push Button | 1.62 | 1.31 | 1.44 | 2.25 | 1.94 | 1.00 |
| | 1.375 in Dia. Mushroom | 1.62 | 1.31 | 1.44 | 2.25 | 1.94 | 1.00 |
| | 2.25 in Dia. Mushroom | 2.25 | 1.31 | 1.44 | 2.25 | 2.25 | 1.12 |
| | Selector Switch Knobs | 1.62 | 1.31 | 1.44 | 2.25 | 1.94 | 1.00 |
| KN6 | Standard Push Button | 2.25 | 1.31 | 1.62 | 2.38 | 2.38 | 0.88 |
| | 1.375 in Dia. Mushroom | 2.25 | 1.31 | 1.62 | 2.38 | 2.38 | 0.88 |
| | 2.25 in Dia. Mushroom | 2.25 | 1.31 | 1.62 | 2.38 | 2.38 | 1.12 |
| | Selector Switch Knobs | 2.25 | 1.31 | 1.62 | 2.38 | 2.38 | 0.88 |

Special Legend Plates

9001KN500
(For Use with Dual Function Operators: KR6, KR7 and KR67)
Standard Markings

| Reference | Green | Red |
|-----------|---------|---------|
| KN500 | Blank | Blank |
| KN501 | Start | Stop |
| KN502 | On | Off |
| Reference | Black | Black |
| KN520 | Blank | Blank |
| KN521 | Start | Stop |
| KN522 | On | Off |
| KN523 | Forward | Reverse |
| KN524 | Up | Down |
| KN525 | High | Low |
| KN526 | Open | Close |

Harmony™ 9001K/SK/KX

30 mm push buttons

9001SK – Accessories

Note: When ordering, add prefix “9001” to the reference.





| Padlock Attachments | | | |
|---|--|--|-------------|
| | Used On | Description | Reference |
|  | Non-illuminated push button — Standard or mushroom (KR4, KR5 mushroom buttons only). | Holds button in depressed position and can be padlocked. | K4 |
|  | Non-illuminated push buttons with or without protective boots. | Holds button in depressed position when padlocked. | K5 |
|  | Non-illuminated push buttons with or without protective boots. | Holds button in depressed position when padlocked. | K97 |
|  | Non-illuminated push buttons, cover type attachment. KR, SKR | Attachment can be padlocked. Does not hold button in depressed position. | K6 |
|  | Push buttons, cover type attachment. | Spring loaded cover cannot be padlocked. Does not hold button in depressed position. | K60 |
|  | Push-pull operator and illuminated push buttons. KR8, KR9 | Holds button in depressed position and can be padlocked. | K62 |
|  | KR11U and KR12U Interlocked Assembly | Holds maintained button in depressed position and can be padlocked. | K96 |
|  | 9001SKR9 Push-pull operators— Non-Illuminated and Illuminated | Holds button in depressed position. Can be padlocked. | K162 |

Mushroom Button Guards



| Reference | Reference | Used On |
|------------|------------------|------------|
| K48 | K56▲ (1) | SKR4 |
| | K56■M (2) | SKR8, SKR9 |

(1) Replace ▲ with B=Black, G=Green, R=Red or Y=Yellow.
 (2) Replace ■ with R=Red or Y=Yellow. The mushroom guard has finger holes for push-pull operators.

| Padlock Attachments | | | |
|--|---|--|-------------|
| | Used On | Description | Reference |
|  | Selector switches and potentiometers (will not work with gloved-hand knob). | Cover type attachment that can be padlocked to keep unauthorized personnel from tampering with the operator. | K7 |
|  | Selector switches and potentiometers (will not work with gloved-hand knob). | Same as 9001K7 but with spring loaded lockout cover. | K107 |
|  | Illuminated push buttons (with or without guard) and key operated push buttons. | Cover type attachment that can be padlocked to keep unauthorized personnel from tampering with the operator. | K108 |
|  | Illuminated push buttons (with or without guard) and key operated push buttons. | Same as 9001K108 but with spring loaded lockout cover. | K109 |
|  | Maintained push-pull operators using 1.375 in dia. mushroom buttons (-20 series as shown on page 58). | Cover type attachment that holds mushroom button in depressed position and can be padlocked. | K110 |

Protective Boots



These 9001KU protective boots are recommended for very dirty environments or severe hose down, but they are not required for UL Type 4 or 4X rating on the 9001SK operators. The 9001K1 wrench (see page 59) is required for installation of these boots.

| For Non-Illuminated Push Buttons (3) | | Clear Color for | Reference |
|--------------------------------------|------------|--|-------------|
| Color | Reference | Standard knob selector switch | KU17 |
| Black | KU1 | Gloved-hand cap for use on standard knob selector switch | KU18 |
| Red | KU2 | | |
| Blue | KU3 | | |
| Brown | KU4 | Standard pilot light and maintained contact push buttons | KU27 |
| Green | KU5 | | |
| Yellow | KU6 | | |
| Clear | KU7 | Push-to-test and illuminated push button without guard | KU37 |
| Clear | KU8 | Illuminated push button with guard | KU47 |

(Provides Full Guard)

(3) Use KU27 for maintained contact push buttons.

Closing Plates



| Description | Reference |
|-------------|----------------|
| Gray | K51 (4) |
| Black | K52 (4) |

(4) Meets UL and NEMA 1, 2, 3, 4, 4X, 6, 12 and 13.

Harmony™ 9001K/SK/KX

30 mm push buttons

9001SK – Accessories

Note: When ordering, add prefix “9001” to the reference.

| Accessories | | | | | | | |
|---|---------------|---------------|--------------|--|-------------|-------------|--------------|
| Description | Color | Reference | Package Qty. | Description | Color | Reference | Package Qty. |
|  <p>Color inserts for KR1, KR2, KR3, KR11, KR12, KRD, T, TRD</p> | Black | T8BK | 10 |  <p>1-3/8 in Mushroom Knob for Illuminated Push Buttons K2L (9)</p> | Amber | A20 | 1 |
| | Blue | T8BE | | | Blue | L20 | |
| | Gray | T8GY | | | Clear | C20 | |
| | Green | T8GN | | | Green | G20 | |
| | Orange | T8OE | | | Red | R20 | |
| | Red | T8RD | | | White | W20 | |
| | Universal (1) | T8U | 7 | | Yellow | Y20 | |
| | White | T8WH | 10 |  <p>2-1/4 in Mushroom Knob for Illuminated Push Buttons K2L (9)</p> | Amber | A21 | 1 |
| | Yellow | T8YW | | | Blue | L21 | |
| | Black | K16B | 1 | | Clear | C21 | |
| | Blue | K16L | | | Green | G21 | |
| | Green | K16G | | Red | R21 | | |
| | Orange | K16S | | White | W21 | | |
| | Red | K16R | | Yellow | Y21 | | |
| | Red (2) | K16R05 | |  <p>Plastic Fresnel Pilot Light Lens for KP, KT</p> | Amber | A31 | 1 |
| | Yellow | K16Y | | | Blue | L31 | |
| | Black | K17B | 1 | | Clear | C31 | |
| | Blue | K17L | | | Green | G31 | |
| | Green | K17G | | Red | R31 | | |
| | Orange | K17S | | White | W31 | | |
| | Red | K17R | | Yellow | Y31 | | |
| | Red (2) | K17R05 | |  <p>Domed Plastic Pilot Light Lens for KP, KT</p> | Amber | A9 | 1 |
| | Yellow | K17Y | | | Blue | L9 | |
| | Black | K92B | 1 | | Clear | C9 | |
| | Blue | K92L | | | Green | G9 | |
| | Green | K92G | | Red | R9 | | |
| | Orange | K92S | | White | W9 | | |
| | Red | K92R | | Yellow | Y9 | | |
| | Yellow | K92Y | |  <p>Glass Pilot Light Lens for KP, KT</p> | Amber | A6 | 1 |
| | Black | K93B | 1 | | Blue | L6 | |
| | Blue | K93L | | | Clear | C6 | |
| | Green | K93G | | | Green | G6 | |
| | Orange | K93S | | Red | R6 | | |
| | Red | K93R | | White | W6 | | |
| | Yellow | K93Y | | Yellow | Y6 | | |
| | Amber | A22 | 1 |  <p>Standard Selector Switch Knob for 9001K Selector Switches</p> | Amber | A8 | 1 |
| | Black (7) | B23 | | | Black (7) | B11 | |
| | Blue | L22 | | | Blue | L8 | |
| | Clear | C22 | | | Clear | C8 | |
| | Green | G22 | | Green | G8 | | |
| | Orange (7) | S23 | | Orange (7) | S11 | | |
| | Red | R22 | | Red | R8 | | |
| | Red (10) | R2205 | | White | W8 | | |
| | White | W22 | | Yellow | Y8 | | |
| | Yellow | Y22 | |  <p>Gloved-Hand Selector Switch Knob for 9001K Selector Switches</p> | Amber | A24 | 1 |
| | Black | B19 | 10 | | Black (7) | B25 | |
| | Green | G19 | | | Blue | L24 | |
| | Red | R19 | | | Clear | C24 | |
| | Universal (8) | U19 | | Green | G24 | | |
| | Amber | A7 | 1 | Orange (7) | S25 | | |
| | Blue | L7 | | Red | R24 | | |
| | Clear | C7 | | White | W24 | | |
| | Green | G7 | | Yellow | Y24 | | |
| | Red | R7 | |  <p>Color Inserts for KQ and TQ Selector Push Buttons</p> | Black | T5BK | 10 |
| | White | W7 | | | Blue | T5BE | |
| | Yellow | Y7 | | | Green | T5GN | |
| | Red | R94 | 1 | | Orange | T5OE | |
| | Red | K92RM | 1 | Red | T5RD | | |
| | Green | K92GM | | White | T5WH | | |
| | Black | K92BM | | Yellow | T5YW | | |
| | Red | K93RM | 1 |  <p>Selector Switch Cams</p> | Description | Cam | Reference |
| | Green | K93GM | | | B | | K13B |
| | Black | K93BM | | | C | | K13C |
| | Red | K94RM | 1 | | D | | K13D |
| | Green | K94GM | | E | | K13E | |
| | Black | K94BM | | F | | K13F | |
| | Red | K95RM | 1 | G | | K13G | |
| | Green | K95GM | | H | | K13H | |
| | Black | K95BM | | J | | K13J | |
| | Red | K95RM | 1 | L | | K13L | |
| | Green | K95GM | | M | | K13M | |
| | Black | K95BM | | | | | |

(1) Includes one each of the following color inserts: Black, Red, Green, Yellow, Orange, Blue, and White.
 (2) “EMERGENCY STOP” is in raised letters and hot stamped white across the front of the mushroom button.
 (3) The mushroom button cap listed here may be assembled to a 9001KR1U to form a 9001KR4.
 (4) The mushroom button cap listed here may be assembled to a 9001KR1U to form a 9001KR5.
 (5) The mushroom button cap listed here may be assembled to a 9001KR20 to form a 9001KR24.
 (6) The mushroom button cap listed here may be assembled to a 9001KR20 to form a 9001KR25.
 (7) These color caps are opaque and are for use on non-illuminated operators only.
 (8) Includes two of each of the following color inserts: Black, Red, and Green.
 (9) May be used on KR8 and KR9 operators. Order mushroom button and K54 adapter (no charge) from page 59. Using the K54 adapter voids Type 6 rating.
 (10) Red knob with “Push Emergency Stop” marked on top of knob.

Harmony™ 9001K/SK/KX

30 mm push buttons

9001SK – Replacement parts

| Ring Nuts | |
|----------------------------|------------|
| Used On | Reference |
| SK1L | 9001SK44 |
| — | — |
| — | — |
| SK20, SK21, SK22, SK23 | 9001SK45 |
| SK20, SK21, SK22, SK23 (3) | 9001SK46 |
| SK2L | 9001SK49 |
| — | — |
| — | — |
| SKP, SKTR | 9001SK41 |
| SKR1 | 9001SK41 |
| SKR11 | 9001SK42 |
| SKR12 (1) | 9001SK42 |
| SKR12 (2) | 9001SK41 |
| — | — |
| SKR2 | 9001SK42 |
| — | — |
| — | — |
| SKR25 | 9001SK49 |
| SKR3 | 9001SK40 |
| SKR4 | 9001SK41 |
| SKR5 | 9001SK41 |
| — | — |
| — | — |
| — | — |
| SKR8 | 6509704401 |
| SKR9 | 9001SK41 |
| SKS | 9001SK45 |
| SKS (3) | 9001SK46 |
| SKRU11 | 9001SK41 |
| SKRU1,2,3,4,5,10 | 9001SK40 |
| SKT | 9001SK49 |

(1) Maintained button of two button operator.

(2) Momentary button of two button operator.

(3) Secondary ring nut (holds knob on selector switch or potentiometer).

Replacement Lamps For Series A–F (black) Light Modules

| Light Module Reference | Lamp Number (ANSI) | Schneider Electric Replacement Lamp Reference |
|------------------------|--------------------|---|
| KM1 | GE44 (4) | — |
| KM2 | GE1490 | 2550101003 |
| KM3 | GE44 (4) | — |
| KM4 | GE1490 | 2550101003 |
| KM5 | GE44 (4) | — |
| KM6 | GE44 (4) | — |
| KM7 | GE44 (4) | — |
| KM8 | GE44 (4) | — |
| KM9 | GE755 | 2550101020 |
| KM11 | CMDK1A5 | 2550105014 |
| KM12 | CMDK1A5 | 2550105014 |
| KM13 | CMDK1A5 | 2550105014 |
| KM14 | CMDK1A5 | 2550105014 |
| KM15 | CMDK1A5 | 2550105014 |
| KM21 | SYL12PSB | 2550105003 |
| KM22 | SYL12PSB | 2550105003 |
| KM23 | SYL28PSB | 2550105008 |
| KM25 | SYL120PSB | 2550105005 |
| KM31 | SYL6PSB | 2550105007 |
| KM32 | SYL12PSB | 2550105003 |
| KM34 | SYL24PSB | 2550105004 |
| KM35 | SYL28PSB | 2550105008 |
| KM36 | SYL48PSB | 2550105009 |
| KM37 | SYL60PSB | 2550105010 |
| KM38 | SYL120PSB | 2550105005 |

(4) GE44 and GE755 are interchangeable (GE755 gives longer life). If a GE44 lamp is ordered, a GE755 (2550101020) will be substituted. For a replacement lamp in a current series light module see the light module listing on page 54.

Product range:
page 36

Specifications:
page 38

Dimensions:
page 60

Mounting:
page 61

| Repair Parts | |
|--|------------|
| Description | Reference |
| E10 Key | 2941101100 |
| Gray cap for 9001SKR11, or 9001SKR12 | 3105217001 |
| Clear plastic top (only) for 9001SK44 Ring Nut | 4487D63XI |
| Gasket for 9001K and 9001SK Push-pull Knob | 6509701801 |
| Gasket for Plastic Illuminated Lens | 6509701901 |
| Gasket for 9001SK selector switch knob | 3105406401 |
| Black Compensating Gasket | 6509702001 |
| Liner for Non-Illuminated Operators | 6509704901 |
| Locking Thrust Washer | 6512231201 |
| Nylon Spacer | 6509705001 |
| Locking Thrust Washer (Std. 9001SK Operator) | 6512240601 |
| Push-pull Mushroom Adapter (5) | 9001K54 |
| Rubber Boot for Joystick | 6512243201 |
| Knob on Joysticks without latch | 4458D20X3 |
| Knob for SK Potentiometer | 3105404408 |
| Fingersafe Cover for 9001KM | 6508804101 |

(5) Allows Type -20 and -21 mushroom color caps to be used on push-pull operators. Use of 9001K54 voids Type 6 rating.

| KU Replacement Ring Nuts (Threaded Inside and Out) | |
|--|------------|
| Used On | Reference |
| KU1 through KU8, KU27, KU37, KU47 | 3105204101 |
| KU17, KU18 | 3105205901 |

| Interlock | |
|---|--|
|  | <p>For mechanically interlocking two push buttons so that only one button can be depressed at a time. A K3 attachment is furnished with the 9001SKR11, SKR12, SKRU1 and SKRU11 operators. However, these are maintained operators and the K3 interlock serves to release one of the buttons when the other is depressed. When used with momentary contact buttons, the K3 interlock does not hold the buttons in the depressed position. It simply prevents pushing both buttons at the same time.</p> <p>The K3 interlock is mounted behind the operators. Operators not included.</p> |
| | Reference |
| | 9001K3 |

| Screwdriver | |
|-------------|---|
| Reference |  |
| 9001K69 | Used to tighten mounting screws on contact blocks and light modules. |

| Wrenches | |
|----------|---|
| K95 |  |
| K1 |  |

| Where Used | Reference |
|--|-----------|
| For tightening ring nuts on 22 and 30 mm control units | 9001K95 |
| For protective cap kits | 9001K1 |

Harmony™ 9001K/SK/KX

30 mm push buttons

9001SK

Dimensions

Push buttons



e: panel thickness 1 to 6 mm

Full guard
9001SKR1●●●



No guard
9001SKR3●●●



No guard with extended guard
9001SKR2●●●



Mushroom head push buttons

Spring return 35 mm:
9001SKR24●H13,
9001SKR4RH6,
9001SKR9R20H6

Spring return 57 mm:
9001SKR25●H13,
9001SKR5RH6

Push-pull 35 mm:
9001SKR9R20H6
Push-pull 41 mm:
9001SKR9●H13,
9001SKR9RH6
9001SKR8●H25
Push-pull 57 mm:
9001SKR9R21H6

Spring return 35, 57 and 60 mm a = 28 mm

Push-pull 35 to 60 mm a = 32 mm



e: panel thickness 1 to 6 mm



Turn-to-release 9001SKR16H13, 9001SKR16H2 and 9001SKR16



e: panel thickness 1 to 6 mm



Selector switches



e: panel thickness 1 to 6 mm

Gloved handle 9001SKS●●FBH●●



Dual Dimensions: in (mm)

Mounting

Contact block mounting position



1 It is possible to mount up to 3 levels of contacts blocks (maximum of 6 contacts blocks) on 9001SK references. For Maximum Contact Block usage, see Page 50.

Panel cut-out



Individual cut-outs detail

2 alternatives



| Type of 9001K unit | Legend plate | a: in (mm) | b: in (mm) |
|---|--------------|-------------|-------------|
| All units except 57 mm mushroom head push buttons | 9001KN2●● | 2.25 (57.2) | 1.75 (44.5) |
| | 9001KN3●● | 2.25 (57.2) | 2.00 (50.8) |
| 57 mm mushroom head push buttons | 9001KN2●● | 2.25 (57.2) | 2.25 (57.2) |
| | 9001KN3●● | 2.25 (57.2) | 2.25 (57.2) |

Harmony™ 9001K/SK/KX

30 mm push buttons

9001SK

Dimensions (continued)

Pilot lights

With BA 9s bulb 9001SKP●●●



e: panel thickness 1 to 6 mm

Illuminated mushroom head push buttons

9001SKR●P●●●



e: panel thickness 1 to 6 mm

Illuminated push buttons, spring return

Full guard 9001SK3L●●●●●H13



e: panel thickness 1 to 6 mm

Heads for spring return push buttons

9001SKR●U



No guard 9001SK2L●●●●●H13



e: panel thickness 1 to 6 mm

Boots for push buttons

9001KU●

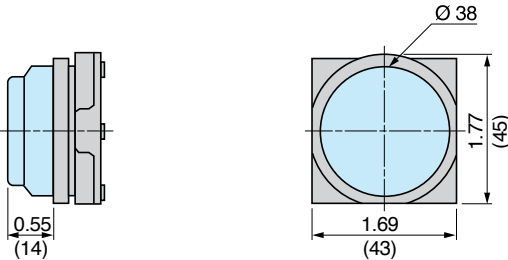

Push-to-test, no guard 9001SKT●●●●●31



e: panel thickness 1 to 6 mm

Dual Dimensions: in (mm)

Dimensions (continued)

Rod for wobble stick

9001K8



Light blocks for pilot lights and illuminated push buttons

9001KM●



e: panel thickness 1 to 6 mm

Contact blocks for push buttons (including illuminated)

9001KA●



e: panel thickness 1 to 6 mm

It is not possible to mount complementary contact blocks 9001KA4 to KA6.

Legend plates

Aluminium plates 9001KN1●●, 9001KN2●●, 9001KN7●●



| Legend plate | a: in (mm) | b: in (mm) |
|--------------|------------|------------|
| 9001KN2●● | 1.625 (41) | 0.969 (24) |
| 9001KN3●● | 1.750 (45) | 1.234 (31) |

Plastic plates 9001KN1●●P, 9001KN2●●P, 9001KN7●●P



| Legend plate | a: in (mm) | b: in (mm) |
|--------------|------------|------------|
| 9001KN1●●P | 2.25 (57) | 2.25 (57) |
| 9001KN2●●P | 1.75 (45) | 1.75 (45) |
| 9001KN7●●P | 2.50 (63) | 2.50 (63) |

Interlocked push buttons

9001SKR11, 9001SKR12



Potentiometer

9001SK20 (1), 9001SK21 (2)



(1) Without potentiometer
(2) With potentiometer

9001SK22 (1), 9001SK23 (2)



(1) Without potentiometer
(2) With potentiometer

Dual Dimensions: in (mm)

Harmony™ 9001K/SK/KX

30 mm push buttons

9001SK

Dimensions (continued)

Time delay push button

9001KRD

Alternate action—Push-on, push-off module

9001K85



| | a | b |
|-------------|----------------------|-------|
| 9001KRD1UH● | Full guard 9/16 | 2-1/2 |
| 9001KRD2UH● | Extended guard 11/16 | 2-1/2 |
| 9001KRD3UH● | No guard 9/16 | 2-1/2 |

Emergency break glass operator

9001K15

Rocker arm operating lever

9001K50

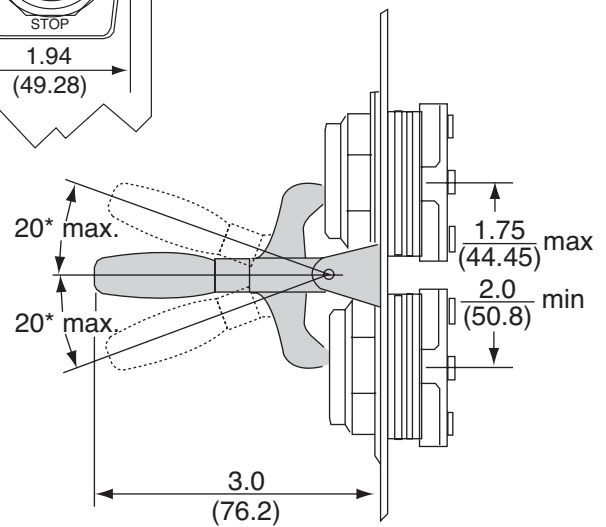

Dual Dimensions: in (mm)

Harmony™ 9001K/SK/KX

30 mm push buttons

9001SK

Dimensions (continued)

Padlock attachments

9001K4



9001K96



9001K7, 9001K107, 9001K108, 9001K109, 9001K113

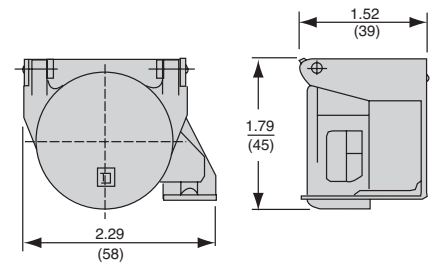

9001K6, 9001K60, 9001K97



9001K62



9001K5

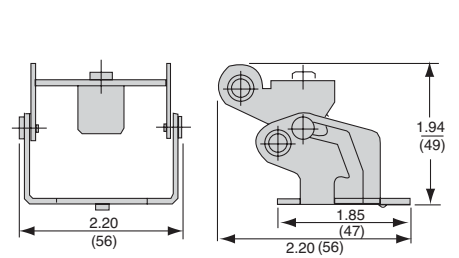

Mushroom button guards

9001K48



9001K56Y, 9001K56YM (1)



9001K68



(1) 9001K56YM includes finger holes.

Dual Dimensions: in (mm)

Complete units

Non-illuminated push buttons

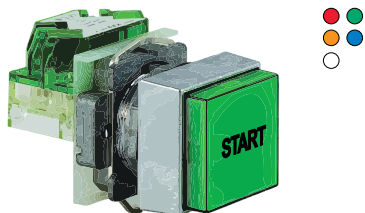

Non-illuminated single push button with contacts
9001KXRA133 See page 70



Non-illuminated dual push button with contacts
9001KXRC136 See page 70

Illuminated push buttons



Illuminated single push button with contacts
9001KXRB1RH1 See page 70



Dual push button with 1 pilot light and contacts
9001KXRG137 See page 70



Dual push button with 2 pilot light and contacts
9001KXRL138 See page 70

Selector switches

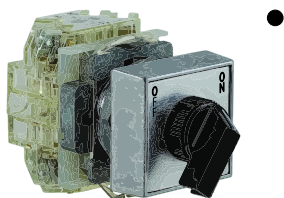

Selector switch
9001KXSA139 See page 71

Pilot lights



Pilot light
9001KXPA1R See page 71

Harmony™ 9001K/SK/KX

30 mm push buttons

9001KX

| Environmental specifications | | |
|---|--|---|
| Conforming to standards |   | UL 508, CSA C22-2 n° 14, CE marked, RoHS compliant |
| Product certifications |  File E78403 CCN NKCR  File LR25490C Class 3211 03 | UL File E78403, CSA File LR25490C, Guide 184N13-1U |
| Protective treatment standard version | | "TC" |
| Ambient air temperature around the device | Storage | °F (°C) -40 to +158 (-40 to +70) |
| | Operation | °F (°C) -22 to +140 at 50% relative humidity (-30 to +60) |
| Degree of protection | Conforming to EN/IEC 60529 | IP 66 |
| | Conforming to NEMA | Types 1, 2, 3, 3R, 4, 12 and 13 |
| Mechanical life (in millions of operating cycles) | Push buttons, spring return | 5 |
| | Illuminated push buttons | 5 |
| | Selector switches and key switches | 0.5 |
| Mounting position | | All positions |

| Electrical characteristics of contact blocks | | | | | | |
|---|---|--|------|------|------|-----|
| Rated operational characteristics | ~ AC-15 | 3 A, 240 V | | | | |
| | ≡ DC-13 | 0.55 A, 125 V | | | | |
| Rated insulation voltage | Conforming to EN/IEC 60947-1 | V U _i = 250 degree of pollution 3 (except pilot lights with incandescent bulb: degree of pollution 2) | | | | |
| Rated impulse withstand voltage | Conforming to EN/IEC 60947-1 | kV U _{imp} = 2.5 | | | | |
| Contact material | Normal environment and usage | Silver alloy | | | | |
| Contact operation | "N/C" ou "N/O" | Slow break | | | | |
| Positive operation | Conforming to EN/IEC 60947-5-1 | N N/C contact(s) with positive opening operation | | | | |
| Short-circuit protection | Conforming to EN/IEC 60947-5-1 | A Cartridge fuse mounted upstream: 10 | | | | |
| Cabling capacity (9001KA contact blocks and 9001KM light modules) | Conforming to EN/IEC 60947-1 | mm ² mm ² Screw clamp terminals (cross headed/slotted screw) Mini: 1 x 0.22 Maxi: 2 x 1.5 Recommended tightening torque: 0.8 N.m (10 in-lbs) | | | | |
| Thermal current | I _{th} | A 10 | | | | |
| Maximum operation current | a.c. supply: utilization category AC-15 NEMA A600 | Contact making capacity | | | | |
| | | V | 120 | 240 | 480 | 600 |
| | | A | 60 | 30 | 15 | 12 |
| | VA | 7200 | 7200 | 7200 | 7200 | |
| | d.c. supply: utilization category DC-13 NEMA Q600 | Breaking capacity | | | | |
| | | V | 120 | 240 | 480 | 600 |
| A | | 6 | 3 | 1.5 | 1.2 | |
| VA | 720 | 720 | 720 | 720 | | |
| | | Contact making capacity and breaking capacity | | | | |
| V | 125 | 250 | 600 | | | |
| A | 0.55 | 0.27 | 0.1 | | | |

Basic Operators

| Description | UL Types/NEMA Types |
|--|------------------------------|
| Single Push Buttons | 4, 4X, 13 |
| Dual Push Buttons | 9001KXRA, 9001KXRB |
| Dual Push Buttons with One Pilot Light | 9001KXRC, 9001KXRD, 9001KXRE |
| Dual Push Buttons with Two Pilot Light | 9001KXRG, 9001KXRJ |
| Selector Switches | 9001KXRL |
| Potentiometers | 9001KXS |
| | 9001KXB |

Non Hazardous Locations:



File E42259
CCN NKCR



File LR25490
Class 3211 03



Marking

The KX operators are rated UL Types 1, 2, 3, 3R, 4, 4X, 6, 12, 13/ NEMA Types 1, 2, 3, 3R, 4X, 6, 12, 13 without the use of protective boots. Boots are recommended for dirty environments or areas that are hosed down with water under very high pressure.

Mounting

Panel cut-out



Individual cut-outs detail

2 alternatives



Preferred Cut-Out

Alternate Cut-Out

Use Greenlee Tool #60242 for punching hole and notch.

9001KX Operator Materials

Single Push Button (KXRA, KXRB, KXRN, KXRP, KXTA)

Gasket – Nitrile
 Locking Head – ZAMAC #3
 Screws – Steel
 Terminals – Steel
 Button – Polycarbonate
 Seal – Nitrile
 Seal Retainer – Steel
 Bezel – Zinc
 Stem – Polycarbonate
 Stem Cover – Polycarbonate
 Legend Insert – Polyester
 Return-Spring – Music Wire
 Ring Nut – Zinc or Aluminum
 Adaptor – Zinc
 Adaptor Mounting Clip – Music Wire
 Liner – Nylon

Dual Push Button (Non-Illuminated and Illuminated) (KXRC, KXRD, KXRE, KXRF, KXRG, KXRH, KXRJ, KXRK, KXRL, KXRM, KXTC)

Gasket – Nitrile
 Seal – Nitrile
 Seal Retainer – Brass
 Bezel – Zinc
 Button Stem – Stainless Steel
 Button – Polycarbonate
 Button Cover – Polycarbonate
 Legend Insert – Polyester
 Lamp Cover – Polycarbonate
 Lens Retainer – Polycarbonate
 Lens – Polycarbonate
 Return-Spring – Music Wire
 Ring Nut – Zinc or Aluminum
 Adaptor – Zinc
 Adaptor Mounting Clip – Music Wire
 Liner – Nylon
 Retainer Ring – Steel
 Interlock Pad – Polyester
 Interlock – Sintered Steel
 Interlock – Nylon (KXRD)
 Pin – Steel (KXRE, KXRF)
 Detent Bearing – Steel (KXRE, KXRF)
 Detent Spring – Music Wire (KXRE, KXRF)
 Interlock – Steel (KXRM)
 Baffle – Steel
 Locking Head – ZAMAC #3
 Screws – Steel
 Stem – Polycarbonate
 Stem Cover – Polycarbonate
 Terminals – Steel

Selector Switch (Non-Illuminated and Illuminated) (KXS)

Gasket – Nitrile
 Seal – Nitrile
 Seal Retainer – Steel
 Return Spring – Music Wire
 Cam Rotor – Celenex 3300
 Cam Follower – Delrin 100
 Cam Carrier – Trogamid
 Cam Profile – Delrin 100
 Bearing – Polyester
 Bezel – Zinc
 Knob – Polycarbonate or Nylon
 Knob Ring Nut – Polycarbonate
 Knob Seal – Nitrile
 Legend Plate – ABS
 Plug Insert – Polyester
 Key Plug – Zinc, Brass, Music Wire
 Key – Brass
 Locking Head – Zinc
 Locking Head Seal – Nitrile
 Insert – Zinc
 Adaptor – Zinc
 Adaptor Mounting Clip – Music Wire
 Liner – Nylon
 Ring Nut – Zinc or Aluminum
 Terminals – Steel
 Screws – Steel

Contact Block (9001KA)

Housing – Amorphous Nylon
 Contact Slider – Nylon or Acetal
 Terminal – Steel
 Saddle Clamp – Steel
 Spring – Steel
 Contacts – Silver and Copper
 Blade – Beryllium Copper
 Label – Paper
 Shrouds – Delrin 507
 Lockout – 410 Stainless Steel
 Closing Plate – ZAMAC #3
 Boots – Neoprene

Potentiometer (KXBA, KXBB, KXBC, KXBD):

Pot – Clarostat Types J and EJ
 Operator – ZAMAC #3
 Legend Plate – ABS
 Knob – Polycarbonate
 Printed circuit board – Phenolic
 Cam Rotor – Polyester
 Cam – Acetal
 Cam Carrier – Nylon
 Adaptor – ZAMAC #3
 Adaptor Spring – Square Music Wire
 Spacer – Fiber Board
 Gasket – Buna N
 Terminal – Brass
 Screws – Steel
 Bezel – Zinc
 Locking Head – ZAMAC #3
 Legend Inserts (KXN100, KXN200, KXN300, KXN400, KXN500)
 – 0.005 Thk. Matte Polyester
 Legend Plates (KXN-600, KXN-700) – ABS

Pilot Light (KXPA, KXPB, KXPC, KXTE)

O-Ring – Nitrile
 Bezel – Zinc
 Button – Polycarbonate
 Button Cover – Polycarbonate
 Button Stem – Polycarbonate
 Screws – Steel
 Terminals – Steel
 Lens Assembly – Polycarbonate
 Baffle – Steel
 Ring Nut – Zinc or Aluminum
 Adaptor – Zinc
 Adaptor Mounting Clip – Music Wire

Light Module (Single Lamp KM)

Housing – Thermoplastic Polyester
 Socket – Steel
 Terminal – Steel with Tin Plate
 Saddle Clamp – Steel
 Translating Pin – Polycarbonate
 Transformer – Thermoplastic Polyester, Steel, Copper,
 Polyvinyl Chloride, Polytetrafluoroethylene, Acetate, Paper
 Lamp Spring – Tin Plated Music Wire

Light Module (2 Lamp KXAKM2)

Adaptor Screw – Steel
 Housing – Thermoplastic Polyester
 Lamp Terminal – Copper
 Terminal – Steel
 Saddle Clamp – Steel
 Contact Spring – Copper
 Translating Pin – Polycarbonate
 Transformer – Thermoplastic Polyester, Steel, Copper, Polyvinyl
 Chloride, Polytetrafluoroethylene, Acetate, Paper

Light Module (4 Lamp KXAKM4)

Housing – Thermoplastic Polyester
 Lamp Terminal – Copper
 Adaptor Screw – Steel
 Terminal – Steel
 Saddle Clamp – Steel
 Transformer – Nylon, Steel, Copper, Polyvinyl Chloride,
 Polytetrafluoroethylene, Acetate, Paper

Harmony™ 9001K/SK/KX

30 mm push buttons

9001KX – Push buttons with contacts

Note: When ordering, add prefix “9001” to the reference.



| Push Buttons—Single, with Contacts | | | | | | |
|------------------------------------|--------------|----------------|---------------|---------|------------------|--|
| Description | Button Color | Legend Marking | Contacts | Voltage | Reference | |
| Non-Illuminated | Green | Start | 1 N/O | — | KXRA133 | |
| | Red | Stop | 1 N/C | — | KXRA134 | |
| | Amber | blank | 2 N/O + 2 N/C | — | KXRAAH2 | |
| | Green | blank | 2 N/O + 2 N/C | — | KXRAGH2 | |
| Illuminated | Blue | blank | 2 N/O + 2 N/C | — | KXRALH2 | |
| | Amber | blank | 1 N/O + 1 N/C | 24 | KXRB34AH1 | |
| | Green | blank | 1 N/O + 1 N/C | 24 | KXRB34GH1 | |
| | Red | blank | 1 N/O + 1 N/C | 24 | KXRB34RH1 | |
| | Amber | blank | 1 N/O + 1 N/C | 110/120 | KXRB1AH1 | |
| | Green | blank | 1 N/O + 1 N/C | 110/120 | KXRB1GH1 | |
| | Red | blank | 1 N/O + 1 N/C | 110/120 | KXRB1RH1 | |



| Push Buttons—Dual, with Contacts | | | | |
|----------------------------------|-----------------|-------------------|---------------|-----------------|
| Description | Top Button (#1) | Lower Button (#2) | Contacts | Reference |
| Momentary | Start (Green) | Stop (Red) | 2 N/O + 2 N/C | KXRC111 |
| Momentary | Start (Green) | Stop (Red) | 1 N/O, 1 N/C | KXRC136 |
| Momentary | Up (Green) | Down (Green) | 2 N/O | KXRD140 |
| Momentary | blank (Blue) | blank (Blue) | 2 N/O | KXRDLLH7 |
| Maintained (1) | Start (Green) | Stop (Red) | 1 N/O + 1 N/C | KXRE115 |
| Maintained (1) | On (Blue) (2) | Off (Blue) (2) | 3 C/O | KXRELLH3 |
| Maintained (1) | On (Blue) (2) | Off (Blue) (2) | 3 C/O | KXRELLH3 |
| Maintained (1) | On (Blue) (2) | Off (Blue) (2) | 2 N/O + 2 N/C | KXRELLH2 |



Pilot Light at 110–120 V, 50–60 Hz Transformer

| Push Buttons—Dual with One Pilot Light and Contacts | | | | | | |
|---|-----------------|------------------|-------------------|---------------|---------|----------------|
| Description | Top Button (#1) | Middle Lens (#2) | Lower Button (#3) | Contacts | Voltage | Reference |
| Momentary | Start (Green) | On (Red) | Stop (Red) | 2 N/O + 2 N/C | 110/120 | KXRG117 |
| Momentary | Start (Green) | On (Red) | Stop (Red) | 1 N/O, 1 N/C | 110/120 | KXRG137 |
| Maintained (1) | Start (Green) | On (Red) | Stop (Red) | 1 N/O + 1 N/C | 110/120 | KXRJ119 |



Pilot Lights at 110–120 V, 50–60 Hz Transformer

| Push Buttons—Dual with Two Pilot Lights and Contacts | | | | | | | |
|--|-----------------|----------------|-----------------|-------------------|---------------|---------|----------------------|
| Description | Top Button (#1) | Left Lens (#2) | Right Lens (#3) | Lower Button (#4) | Contacts | Voltage | Reference |
| Momentary | Start (Green) | On (Red) | Off (Green) | Stop (Red) | 2 N/O + 2 N/C | 110/120 | KXRL121 |
| Momentary | Start (Green) | On (Red) | Off (Green) | Stop (Red) | 1 N/O, 1 N/C | 110/120 | KXRL138 |
| Momentary | Start (Green) | On (Red) | Off (Green) | Stop (Red) | 2 N/O + 2 N/C | 24 | KXRL34GRGRH2 |
| Momentary | Start (Green) | On (Red) | Off (Green) | Stop (Red) | 1 N/O, 1 N/C | 24 | KXRL34GRGRH37 |

(1) Maintained operators are mechanically interlocked.
 (2) Text is vertical.

Harmony™ 9001K/SK/KX

30 mm push buttons

9001KX – Push buttons without contacts

Note: When ordering, add prefix “9001” to the reference.



Push Buttons—without Contacts (1)

| Push Button | Action | Lens Color (1) | Lens Color (2) | Reference |
|---------------------------|------------------------|----------------|----------------|-----------|
| Single Push Button | | | | |
| Non-Illuminated | Momentary | Amber | — | KXRAA |
| | | Green | — | KXRAG |
| | | Blue | — | KXRAL |
| | | Red | — | KXRAR |
| | | White | — | KXRAW |
| Illuminated 24 V | Momentary | Amber | — | KXRB35A |
| | | Green | — | KXRB35G |
| | | Blue | — | KXRB35L |
| | | Red | — | KXRB35R |
| | | White | — | KXRB35W |
| Illuminated 110/120 V | Momentary | Amber | — | KXRB38A |
| | | Green | — | KXRB38G |
| | | Blue | — | KXRB38L |
| | | Red | — | KXRB38R |
| | | White | — | KXRB38W |
| Dual Push Button | | | | |
| Non-Illuminated | Momentary + Interlock | Green | Red | KXRCGR |
| | | White | White | KXRCWW |
| | | Green | Green | KXRCGG |
| | Maintained + Interlock | Green | Red | KXREGR |
| | | White | White | KXREWW |
| | | Green | Green | KXREGG |



Dual Push Button with Pilot Light—without Contacts (1)

| Action | Voltage | Lens Color (1) | Lens Color (2) | Lens Color (3) | Lens Color (4) | Reference | |
|------------------------------|------------------------|----------------|----------------|----------------|----------------|------------|-----------|
| With One Pilot Light | | | | | | | |
| Momentary | 24 Vac/dc | Red | White | Green | — | KXRG35RWG | |
| | 24 Vac/dc | Green | White | Green | — | KXRG35GWG | |
| | 110/120 Vac/dc | Red | White | Green | — | KXRG38RWG | |
| | 110/120 Vac/dc | Green | White | Green | — | KXRG38GWG | |
| Momentary + Interlock | 24 Vac/dc | Red | White | Green | — | KXRH35RWG | |
| | 24 Vac/dc | Green | White | Green | — | KXRH354GWG | |
| | 110/120 Vac/dc | Red | White | Green | — | KXRH38RWG | |
| 110/120 Vac/dc | Green | White | Green | — | KXRH38GWG | | |
| | Maintained + Interlock | 24 Vac/dc | Red | White | Green | — | KXRJ35RWG |
| | | 24 Vac/dc | Green | White | Green | — | KXRJ35GWG |
| 110/120 Vac/dc | | Red | White | Green | — | KXRJ38RWG | |
| 110/120 Vac/dc | | Green | White | Green | — | KXRJ38GWG | |
| With Two Pilot Lights | | | | | | | |
| Momentary | 24 Vac/dc | Red | White | White | Green | KXRL35RWWG | |
| | 24 Vac/dc | Red | Red | Green | Green | KXRL35GGRR | |
| | 110/120 Vac/dc | Red | White | White | Green | KXRL38RWWG | |
| | 110/120 Vac/dc | Red | Red | Green | Green | KXRL38GGRR | |
| Momentary + Interlock | 24 Vac/dc | Red | White | White | Green | KXRM35RWWG | |
| | 24 Vac/dc | Red | Red | Green | Green | KXRM35RRGG | |
| | 110/120 Vac/dc | Red | White | White | Green | KXRM38RWWG | |
| 110/120 Vac/dc | Red | Red | Green | Green | KXRM38RRGG | | |



(1) Order contacts separately (see page 73). For accessories, see page 74.

Harmony™ 9001K/SK/KX

30 mm push buttons

9001KX – Selector switches, contact blocks

Note: When ordering, add prefix “9001” to the reference.



Selector Switches—with Contacts

| Description | Legend | Knob | Contacts | Reference |
|------------------------|---------------|-------|----------|-----------|
| 2-Position, maintained | Off-On | Black | 1 0 | KXSA125 |
| | | | 0 1 | |
| 2-Position, maintained | Off-On | Black | 1 0 | KXSA139 |
| 3-Position, maintained | Hand-Off-Auto | Black | 1 0 0 | KXSD126 |
| | | | 0 0 1 | |

Selector Switches—without Contacts (1)

| Description | | Voltage | Knob Color | Reference |
|------------------------|---------------------|------------|------------|-----------|
| 2-Position, Maintained | Non-Illuminated | — | Black | KXSAEB |
| | Illuminated | 24 Vac/dc | Red | KXSJE35R |
| | Illuminated | 24 Vac/dc | Green | KXSJE35G |
| | Illuminated | 24 Vac/dc | White | KXSJE35W |
| | Illuminated | 120 Vac/dc | Red | KXSJE38R |
| | Illuminated | 120 Vac/dc | Green | KXSJE38G |
| | Illuminated | 120 Vac/dc | White | KXSJE38W |
| | Key (Withdraw L) | — | N/A | KXSRE1 |
| | Key (Withdraw R) | — | N/A | KXSRE2 |
| 3-Position, Maintained | Key (Withdraw Both) | — | N/A | KXSRE3 |
| | Non-Illuminated | — | Black | KXSDCB |
| | Key (Withdraw C) | — | N/A | KXSVC5 |
| 4-Position, Maintained | Key (Withdraw All) | — | N/A | KXSVC10 |
| | Non-Illuminated | — | Black | KXSHHB |

(1) Order contacts separately (see table below).

Contact Blocks—Purchase Separately

| Description | | Reference | Description | | Reference |
|---|-------------|--------------|--|-------------|---------------------------|
|  | Clear Cover | 1 N/O, 1 N/C |  | Clear Cover | 1 N/C, 1 N/O (Early Make) |
|  | Green Cover | 1 N/O |  | Red Cover | 1 N/C (Late Break) |
|  | Red Cover | 1 N/C |  | Green Cover | 1 N/O (Early Make) |
| | | KA1 | | | KA4 |
| | | KA2 | | | KA5 |
| | | KA3 | | | KA6 |

Maximum Contact Block Usage:

- 2 blocks mounted side by side only:** Any 2 or 3-Position spring return selector switch (non-illuminated, illuminated or keyed).
- 2 blocks mounted in tandem on one side only:** Any 2 operator interlocked push button.
- 2 blocks mounted in tandem (total of four blocks):** Any selector push button, keyed push button, 2 or 3-Position maintained selector switch (non-illuminated, illuminated or keyed), push pull operators (non-illuminated or illuminated), joy stick, dual push button.
- 3 blocks mounted in tandem (total of six blocks):** Single momentary push buttons (non-illuminated or illuminated).



Potentiometers

| Description | Power | Resistance | Reference |
|-------------|-------|-------------|-----------|
| Single | 2 W | 3.2 kΩ | KXBB06 |
| Single | 2 W | 5 kΩ | KXBB07 |
| Single | 2 W | 10 kΩ | KXBB08 |
| Tandem | 2 W | 5 kΩ / 5 kΩ | KXBD83 |

Harmony™ 9001K/SK/KX

30 mm push buttons

9001KX – Pilot lights

Note: When ordering, add prefix “9001” to the reference.



110–120 V,
50–60 Hz
Transformer



110–120 V, 50–60 Hz.
Transformer



110–120 V, 50–60 Hz
Transformer

Pilot Lights

| Description | Voltage | Lens 1* | Lens 2* | Lens 3* | Lens 4* | Reference |
|-------------|---------|---------|---------|---------|---------|------------|
| Single | 24 | Amber | | | | KXPA35A |
| Single | 24 | Red | | | | KXPA35R |
| Single | 24 | Green | | | | KXPA35G |
| Single | 24 | White | | | | KXPA35W |
| Single | 110/120 | Amber | | | | KXPA1A |
| Single | 110/120 | Red | | | | KXPA1R |
| Single | 110/120 | Green | | | | KXPA1G |
| Single | 110/120 | White | | | | KXPA1W |
| Dual | 24 | Amber | Amber | | | KXPB34AA |
| Dual | 24 | Red | Red | | | KXPB34RR |
| Dual | 24 | Green | Green | | | KXPB34GG |
| Dual | 24 | White | White | | | KXPB34WW |
| Dual | 24 | Red | Green | | | KXPB34RG |
| Dual | 110/120 | Amber | Amber | | | KXPB1AA |
| Dual | 110/120 | Red | Red | | | KXPB1RR |
| Dual | 110/120 | Green | Green | | | KXPB1GG |
| Dual | 110/120 | White | White | | | KXPB1WW |
| Dual | 110/120 | Red | Green | | | KXPB1RG |
| Quad | 24 | White | Amber | Green | Red | KXPC34WAGR |
| Quad | 110/120 | White | Amber | Green | Red | KXPC1WAGR |
| Quad | 110/120 | White | Blue | Green | Red | KXPC1WLGR |

* Lenses are blank (no markings)

Harmony™ 9001K/SK/KX

30 mm push buttons

9001KX – Legend plates

Note: When ordering, add prefix "9001" to the reference.

Legend Plates for Push Buttons or Pilot Lights

| Used On | | | | | | |
|-----------------|--|------------------------|----------------|----------------------------|----------------------|----------------------|
| | A | B | C | D | E | F |
| | | | | | | |
| | C (vertical) | | | | | |
| Marking | A | B | C | D | E | F |
| | KXRA, KXRB, KXRN, KXRP, KXPA, KXPC, KXTA, KXTB, KXTE | KXRC, KXRD, KXRE, KXRF | KXPB, KXTD (3) | KXRG, KXRH, KXRJ, KXRK (1) | KXRL, KXRM, KXTC (2) | KXRL, KXRM, KXTC (1) |
| Blank | KXN100 | KXN200 | KXN200 | KXN300 | KXN400 | KXN500 |
| Start | KXN101 | KXN201 | KXN201V | KXN301 | KXN401 | KXN501 |
| Stop | KXN102 | KXN202 | KXN202V | KXN302 | KXN402 | KXN502 |
| On | KXN103 | KXN203 | KXN203V | KXN303 | KXN403 | KXN503 |
| Off | KXN104 | KXN204 | KXN204V | KXN304 | KXN404 | KXN504 |
| Emerg. Stop | KXN105 | KXN205 | KXN205V | KXN305 | KXN405 | KXN505 |
| Forward | KXN106 | KXN206 | KXN206V | KXN306 | KXN406 | KXN506 |
| Reverse | KXN107 | KXN207 | KXN207V | KXN307 | KXN407 | KXN507 |
| Close | KXN108 | KXN208 | KXN208V | KXN308 | KXN408 | KXN508 |
| Open | KXN109 | KXN209 | KXN209V | KXN309 | KXN409 | KXN509 |
| Down | KXN110 | KXN210 | KXN210V | KXN310 | KXN410 | KXN510 |
| Up | KXN111 | KXN211 | KXN211V | KXN311 | KXN411 | KXN511 |
| Jog | KXN118 | KXN218 | KXN218V | KXN318 | KXN418 | KXN518 |
| Reset | KXN123 | KXN223 | KXN223V | KXN323 | KXN423 | KXN523 |
| Run | KXN124 | KXN224 | KXN224V | KXN324 | KXN424 | KXN524 |
| Cycle Start | KXN132 | KXN232 | KXN232V | KXN332 | KXN432 | KXN532 |
| Motor Run | KXN136 | KXN236 | KXN236V | KXN336 | KXN436 | KXN536 |
| Power On | KXN138 | KXN238 | KXN238V | KXN338 | KXN438 | KXN538 |
| Special-Marking | KXN199 | KXN299 | KXN299V | KXN399 | KXN499 | KXN599 |

- (1) These legend inserts are for the pilot lights in the center of the operator.
- (2) These legend inserts are for the push button portion of the operator.
- (3) These legend inserts have vertical printing.

Legend Plates for Selector Switches

| Used On | | |
|-----------------|--|--|
| | KXN-600 | KXN-700 |
| | | |
| Marking | KXSA, KXSB, KXSC, KXSD, KXSE, KXSF, KXSG, KXSH, KXSJ, KXSK, KXSL, KXSM, KXSN, KXSO, KXSP, KXSQ | KXSR, KXSS, KXST, KXSV, KXSW, KXSX, KXSZ |
| Blank | KXN600 | KXN700 |
| For.-Rev. | KXN639 | KXN739 |
| Hand-Auto | KXN640 | KXN740 |
| Man-Auto | KXN643 | KXN743 |
| Off-On | KXN644 | KXN744 |
| On-Off | KXN645 | KXN745 |
| Open-Close | KXN646 | KXN746 |
| Start-Stop | KXN651 | KXN751 |
| Auto-Off-Hand | KXN658 | KXN758 |
| Hand-Off-Auto | KXN660 | KXN760 |
| Man-Off-Auto | KXN662 | KXN762 |
| Special Marking | KXN699 | KXN799 |

Dual Dimensions: in (mm)



Letter Height For Standard Legends

| Reference | in | mm |
|-----------|------|------|
| KXN100 | 1/4 | 6 |
| KXN200 | 3/16 | 4.75 |
| KXN300 | 3/16 | 4.75 |
| KXN400 | 3/16 | 4.75 |
| KXN500 | 3/16 | 4.75 |
| KXN600 | 1/8 | 3 |
| KXN700 | 1/8 | 3 |

Maximum Number of Lines and Characters For 9001KXN Legend Inserts

| Letter Height in mm | Number of to | KXN199 | | KXN299 | | KXN399 | | KXN499 | | KXN599 | |
|---------------------|-------------------------|------------|----------|------------|----------|------------|----------|------------|----------|------------|----------|
| | | Horizontal | Vertical | Horizontal | Vertical | Horizontal | Vertical | Horizontal | Vertical | Horizontal | Vertical |
| 1/4 6 | Characters per Line | 7 | 7 | 3 | 7 | 7 | 3 | 7 | 7 | 3 | 3 |
| | Lines per Legend Insert | 4 | 2 | 4 | 1 | 1 | 1 | 1 | 1 | 1 | 1 |
| 3/16 4.75 | Characters per Line | 9 | 9 | 4 | 9 | 9 | 4 | 9 | 9 | 4 | 4 |
| | Lines per Legend Insert | 5 | 2 | 6 | 2 | 1 | 2 | 1 | 2 | 2 | 2 |
| 1/8 3 | Characters per Line | 14 | 14 | 5 | 14 | 14 | 5 | 14 | 14 | 6 | 6 |
| | Lines per Legend Insert | 8 | 4 | 9 | 3 | 2 | 3 | 2 | 3 | 3 | 3 |

Maximum Number of Lines and Characters for 9001KXN699 and 9001KXN799 Legend Plates

| Position | Letter Height | | Characters Per Marking Area | |
|----------|---------------|------|-----------------------------|---|
| | in | mm | A and C | B |
| | 3/16 | 4.75 | 6 | 6 |
| | 1/8 | 3 | 8 | 9 |
| | 3/16 | 4.75 | 10 | 5 |
| | 1/8 | 3 | 13 | 7 |

All 9001KX push buttons and pilot lights have a blank insert as standard. These blank inserts can be custom marked using a marking pen, a mechanical lettering set, press letters, or a tape lettering machine that marks a tape which can then be transferred to the blank insert.

To have legend inserts installed into the operators, order the operator as normal and then indicate where to install the legend inserts using the numbered positions shown on the operator ordered.

Example: 9001KXRL1GRGRH2 with a 9001KXN 401 in position 1, 9001KXN 503 in position 2, 9001KXN 504 in position 3, 9001KXN 402 in position 4

Harmony™ 9001K/SK/KX

30 mm push buttons

9001KX – Accessories

Note: When ordering, add prefix “9001” to the reference.

Closing Plate



Reference
KXAK52

UL Types 4, 13/NEMA 4, 13
Square Closing Plate (Chrome Plated)
Same size as KX bezel

Boots



| For Use On | Reference |
|---|-----------------|
| All KX** push buttons and pilot lights | KXAKU7 |
| All KX** selector switches and potentiometers | KXAKU17B |

Shrouds



| Description | For Use On | Color | Reference |
|--------------|--------------------------------------|-------|----------------|
| Full Shroud | All push buttons and pilot lights | Red | KXAK41R |
| | | Black | KXAK41B |
| Short Shroud | Any KX operator | Red | KXAK40R |
| | | Black | KXAK40B |

Lamp and Lens Removal Kit



Used to remove lamp and lens on all
illuminated operators and pilot lights.

Reference
KXALLRT

Button Covers

| Description | For Use On | Color | Reference | Code |
|----------------------|--|-------|-------------------|-------|
| Includes 2-KXN200 | KXPB KXTD | Red | KXAC28 (1) | R (2) |
| | | Green | KXAC28 (1) | G (2) |
| | | Amber | KXAC28 (1) | A (2) |
| | | Blue | KXAC28 (1) | L (2) |
| | | White | KXAC28 (1) | W (2) |
| Includes KXN400 | KXTC (Position 1 & 4) | Red | KXAR4 | R |
| | | Green | KXAG4 | G |
| | | Amber | KXAA4 | A |
| | | Blue | KXAL4 | L |
| | | White | KXAW4 | W |
| Includes KXN500 | KXTC (Position 2 & 3) | Red | KXAR5 | R |
| | | Green | KXAG5 | G |
| | | Amber | KXAA5 | A |
| | | Blue | KXAL5 | L |
| | | White | KXAW5 | W |
| Includes 1-KXN100 | KXPC | Red | KXAC48 (3) | R (4) |
| | | Green | KXAC48 (3) | G (4) |
| | | Amber | KXAC48 (3) | A (4) |
| | | Blue | KXAC48 (3) | L (4) |
| | | White | KXAC48 (3) | W (4) |
| Includes KXN100 | KXRA KXRB | Red | KXAR1 | R |
| | | Green | KXAG1 | G |
| | | Amber | KXAA1 | A |
| | | Blue | KXAL1 | L |
| | | White | KXAW1 | W |
| Includes KXN100 | KXRN KXRP | Red | KXARM1 | R |
| | | Green | KXAGM1 | G |
| | | Amber | KXAA1 | A |
| | | Blue | KXALM1 | L |
| | | White | KXAWM1 | W |
| Includes KXN200 | KXRC KXRD KXRE KXRF | Red | KXAR2 | R |
| | | Green | KXAG2 | G |
| | | Amber | KXAA2 | A |
| | | Blue | KXAL2 | L |
| | | White | KXAW2 | W |
| Includes KXN300 | KXRG (Position 2) KXRH (Position 2) KXRJ (Position 2) KXRK (Position 2) | Red | KXAR3 | R |
| | | Green | KXAG3 | G |
| | | Amber | KXAA3 | A |
| | | Blue | KXAL3 | L |
| | | White | KXAW3 | W |
| Includes KXN400 | KXRG (Position 1 & 3) KXRH (Position 1 & 3) KXRJ (Position 1 & 3) KXRK (Position 1 & 3) KXRL (Position 1 & 4) KXRM (Position 1 & 4) | Red | KXAR4 | R |
| | | Green | KXAG4 | G |
| | | Amber | KXAA4 | A |
| | | Blue | KXAL4 | L |
| | | White | KXAW4 | W |
| Includes KXN500 | KXRL (Position 2 & 3) KXRM (Position 2 & 3) | Red | KXAR5 | R |
| | | Green | KXAG5 | G |
| | | Amber | KXAA5 | A |
| | | Blue | KXAL5 | L |
| | | White | KXAW5 | W |
| Includes KXN100 | KXPA | Red | KXAR8 | R |
| | | Green | KXAG8 | G |
| | | Amber | KXAA8 | A |
| | | Blue | KXAL8 | L |
| | | White | KXAW8 | W |
| Includes KXN100 | KXTA KXTB | Red | KXAR1 | R |
| | | Green | KXAG1 | G |
| | | Amber | KXAA1 | A |
| | | Blue | KXAL1 | L |
| | | White | KXAW1 | W |

- (1) Each KXAC28 includes a clear cover and 1 each of all colors. If the same color is required for position #1 and #2 of the KXPB operator, order 2 of reference KXAC28.
- (2) When specifying color codes—the first will be installed in #1 and the second in #2.
- (3) Each KXAC48 includes a clear cover and 1 each of all colors. If the same color is required for position #1 and #2 of the KXPC operator, order 2 of reference KXAC48.
- (4) When specifying color codes—the first will be installed in #1, the second in #2, the third in #3 and the fourth in #4.
- (5) Two required per operator. When ordering an assembled operator—specify two code numbers. The first code will be assembled into #1 and the second code will be assembled into #2.

Harmony™ 9001K/SK/KX

30 mm push buttons

9001KX

Dimensions

Single Push Button Operator, Non-Illuminated
9001KXRA, 9001KXRN



Selector Switch Operator, Non-Illuminated
9001KXS●



Single Pilot Light

9001KXPA35●, 9001KXPA1●



Dual Push Button Operator, Non-Illuminated

9001KXRC, 9001KXRD, 9001KXRE, 9001KXRF



Key Operator Selector Switch

9001KXS●



Dual Lamp Pilot Light

9001KXPB34●●, 9001KXPB1●●



Single Push Button Operator, Illuminated

9001KXRB, 9001KXRP, 9001KXTA



Selector Switch Operator, Illuminated

9001KXS●



Dual Dimensions: in (mm)

Minimum Centerline Spacings For 9001KX
2-1/4" Vertically 1-5/8" Horizontally

Harmony™ 9001K/SK/KX

30 mm push buttons

9001KX

Dimensions (continued)

Quad Pilot Light

9001KXPC34WAGR, 9001KXPC1W●GR



Dual Push Button Operator, Illuminated

9001KXRG, 9001KXRH, 9001KXRJ, 9001KXRK



Single Potentiometer Operator

9001KXRBB●●



Tandem Potentiometer Operator

9001KXBD83



Dual Lamp Push Button Operator

9001KXRL, 9001KXRM, 9001KXTC



Shroud

9001KXAK41R, 9001KXAK41B, 9001KXAK40R, 9001KXAK40B



Boot

9001KXAKU7, 9001KXAKU17B



Dual Dimensions: in (mm)

Minimum Centerline Spacings For 9001KX
2-1/4" Vertically 1-5/8" Horizontally

Harmony™ 9001K/SK/KX

30 mm push buttons

| | | | | | | | | | |
|---------|------------|---------|--------|---------|--------|---------|----------------|---------|--------|
| KA3G | 20, 50 | KN101BP | 25, 55 | KN129BP | 25, 55 | KN159BP | 25, 55 | KN207BP | 25, 55 |
| KA4 | 20, 50, 72 | KN101SP | 25, 55 | KN129SP | 25, 55 | KN159SP | 25, 55 | KN207SP | 25, 55 |
| KA41 | 23, 53 | KN101WP | 25, 55 | KN129WP | 25, 55 | KN159WP | 25, 55 | KN207WP | 25, 55 |
| KA42 | 23, 53 | KN102RP | 25, 55 | KN130BP | 25, 55 | KN160BP | 25, 55 | KN208 | 25, 55 |
| KA43 | 23, 53 | KN103BP | 25, 55 | KN130SP | 25, 55 | KN160SP | 25, 55 | KN208BP | 25, 55 |
| KA44 | 23, 53 | KN103SP | 25, 55 | KN130WP | 25, 55 | KN160WP | 25, 55 | KN208SP | 25, 55 |
| KA45 | 23, 53 | KN103WP | 25, 55 | KN131BP | 25, 55 | KN162BP | 25, 55 | KN208WP | 25, 55 |
| KA4G | 20, 50 | KN104RP | 25, 55 | KN131SP | 25, 55 | KN162SP | 25, 55 | KN209 | 25, 55 |
| KA5 | 20, 50, 72 | KN105RP | 25, 55 | KN131WP | 25, 55 | KN162WP | 25, 55 | KN209BP | 25, 55 |
| KA51 | 23, 53 | KN106BP | 25, 55 | KN132BP | 25, 55 | KN163BP | 25, 55 | KN209SP | 25, 55 |
| KA52 | 23, 53 | KN106SP | 25, 55 | KN132SP | 25, 55 | KN163SP | 25, 55 | KN209WP | 25, 55 |
| KA53 | 23, 53 | KN106WP | 25, 55 | KN132WP | 25, 55 | KN163WP | 25, 55 | KN210 | 25, 55 |
| KA54 | 23, 53 | KN107BP | 25, 55 | KN133BP | 25, 55 | KN164BP | 25, 55 | KN210BP | 25, 55 |
| KA55 | 23, 53 | KN107SP | 25, 55 | KN133SP | 25, 55 | KN164SP | 25, 55 | KN210SP | 25, 55 |
| KA5G | 20, 50 | KN107WP | 25, 55 | KN133WP | 25, 55 | KN164WP | 25, 55 | KN210WP | 25, 55 |
| KA6 | 20, 50, 72 | KN108BP | 25, 55 | KN134BP | 25, 55 | KN165BP | 25, 55 | KN211 | 25, 55 |
| KA6G | 20, 50 | KN108SP | 25, 55 | KN134SP | 25, 55 | KN165SP | 25, 55 | KN211BP | 25, 55 |
| KM1 | 24, 54 | KN108WP | 25, 55 | KN134WP | 25, 55 | KN165WP | 25, 55 | KN211SP | 25, 55 |
| KM11 | 24, 54 | KN109BP | 25, 55 | KN136BP | 25, 55 | KN167BP | 25, 55 | KN211WP | 25, 55 |
| KM12 | 24, 54 | KN109SP | 25, 55 | KN136SP | 25, 55 | KN167SP | 25, 55 | KN212 | 25, 55 |
| KM14 | 24, 54 | KN109WP | 25, 55 | KN136WP | 25, 55 | KN167WP | 25, 55 | KN212BP | 25, 55 |
| KM1LG | 24, 54 | KN110BP | 25, 55 | KN137BP | 25, 55 | KN170BP | 25, 55 | KN212SP | 25, 55 |
| KM1LR | 24, 54 | KN110SP | 25, 55 | KN137SP | 25, 55 | KN170SP | 25, 55 | KN212WP | 25, 55 |
| KM1LY | 24, 54 | KN110WP | 25, 55 | KN137WP | 25, 55 | KN170WP | 25, 55 | KN213 | 25, 55 |
| KM25 | 24, 54 | KN111BP | 25, 55 | KN138BP | 25, 55 | KN176BP | 25, 55 | KN213BP | 25, 55 |
| KM3 | 24, 54 | KN111SP | 25, 55 | KN138SP | 25, 55 | KN176SP | 25, 55 | KN213SP | 25, 55 |
| KM31 | 24, 54 | KN111WP | 25, 55 | KN138WP | 25, 55 | KN176WP | 25, 55 | KN213WP | 25, 55 |
| KM31LG | 24, 54 | KN112BP | 25, 55 | KN139BP | 25, 55 | KN177BP | 25 | KN214 | 25, 55 |
| KM31LR | 24, 54 | KN112SP | 25, 55 | KN139SP | 25, 55 | KN177SP | 25, 55 | KN214BP | 25, 55 |
| KM31LY | 24, 54 | KN112WP | 25, 55 | KN139WP | 25, 55 | KN177WP | 25, 55 | KN214SP | 25, 55 |
| KM32 | 24, 54 | KN113BP | 25, 55 | KN140BP | 25, 55 | KN178BP | 25 | KN214WP | 25, 55 |
| KM32LG | 24, 54 | KN113SP | 25, 55 | KN140SP | 25, 55 | KN178SP | 25 | KN215 | 25, 55 |
| KM32LR | 24, 54 | KN113WP | 25, 55 | KN140WP | 25, 55 | KN178WP | 25 | KN215BP | 25, 55 |
| KM32LY | 24, 54 | KN114BP | 25, 55 | KN141BP | 25, 55 | KN179BP | 25, 55 | KN215SP | 25, 55 |
| KM33 | 24, 54 | KN114SP | 25, 55 | KN141SP | 25, 55 | KN179SP | 25, 55 | KN215WP | 25, 55 |
| KM35 | 24, 54 | KN114WP | 25, 55 | KN141WP | 25, 55 | KN179WP | 25, 55 | KN216 | 25, 55 |
| KM35LG | 24, 54 | KN115BP | 25, 55 | KN142BP | 25, 55 | KN199AP | 26, 56 | KN216BP | 25, 55 |
| KM35LL | 24, 54 | KN115SP | 25, 55 | KN142SP | 25, 55 | KN199BP | 26, 56 | KN216SP | 25, 55 |
| KM35LR | 24, 54 | KN115WP | 25, 55 | KN142WP | 25, 55 | KN199CP | 26, 56 | KN216WP | 25, 55 |
| KM35LW | 24, 54 | KN116BP | 25, 55 | KN143BP | 25, 55 | KN199GP | 26, 56 | KN217 | 25, 55 |
| KM35LY | 24, 54 | KN116SP | 25, 55 | KN143SP | 25, 55 | KN199HP | 26, 56 | KN217BP | 25, 55 |
| KM36 | 24, 54 | KN116WP | 25, 55 | KN143WP | 25, 55 | KN199LP | 26, 56 | KN217SP | 25, 55 |
| KM38 | 24, 54 | KN117BP | 25, 55 | KN144BP | 25, 55 | KN199RP | 26, 56 | KN217WP | 25, 55 |
| KM38LG | 24, 54 | KN117SP | 25, 55 | KN144SP | 25, 55 | KN199SP | 26, 56 | KN218 | 25, 55 |
| KM38LL | 24, 54 | KN117WP | 25, 55 | KN144WP | 25, 55 | KN199WP | 26, 56 | KN218BP | 25, 55 |
| KM38LR | 24, 54 | KN118BP | 25, 55 | KN145BP | 25, 55 | KN199YP | 26, 56 | KN218SP | 25, 55 |
| KM38LW | 24, 54 | KN118SP | 25, 55 | KN145SP | 25, 55 | KN2 | 21, 26, 51, 56 | KN218WP | 25, 55 |
| KM38LY | 24, 54 | KN118WP | 25, 55 | KN145WP | 25, 55 | KN200 | 25, 55 | KN219 | 25, 55 |
| KM3LG | 24, 54 | KN119BP | 25, 55 | KN146BP | 25, 55 | KN200AP | 26, 56 | KN219BP | 25, 55 |
| KM3LR | 24, 54 | KN119SP | 25, 55 | KN146SP | 25, 55 | KN200BP | 25, 55 | KN219SP | 25, 55 |
| KM3LY | 24, 54 | KN119WP | 25, 55 | KN146WP | 25, 55 | KN200CP | 26, 56 | KN219WP | 25, 55 |
| KM40 | 24, 54 | KN120BP | 25, 55 | KN147BP | 25, 55 | KN200GP | 26, 56 | KN220 | 25, 55 |
| KM5 | 24, 54 | KN120SP | 25, 55 | KN147SP | 25, 55 | KN200HP | 26, 56 | KN220BP | 25, 55 |
| KM55 | 24, 54 | KN120WP | 25, 55 | KN147WP | 25, 55 | KN200LP | 26, 56 | KN220SP | 25, 55 |
| KM55LG | 24, 54 | KN121BP | 25, 55 | KN148BP | 25, 55 | KN200R | 25, 55 | KN220WP | 25, 55 |
| KM55LR | 24, 54 | KN121SP | 25, 55 | KN148SP | 25, 55 | KN200RP | 25, 55 | KN221 | 25, 55 |
| KM55LY | 24, 54 | KN121WP | 25, 55 | KN148WP | 25, 55 | KN200SP | 25, 55 | KN221BP | 25, 55 |
| KM58 | 24, 54 | KN122BP | 25, 55 | KN150BP | 25, 55 | KN200WP | 25, 55 | KN221SP | 25, 55 |
| KM58LG | 24, 54 | KN122SP | 25, 55 | KN150SP | 25, 55 | KN200YP | 26, 56 | KN221WP | 25, 55 |
| KM58LR | 24, 54 | KN122WP | 25, 55 | KN150WP | 25, 55 | KN201 | 25, 55 | KN222 | 25, 55 |
| KM58LY | 24, 54 | KN123BP | 25, 55 | KN151BP | 25, 55 | KN201BP | 25, 55 | KN222BP | 25, 55 |
| KM6 | 24, 54 | KN123SP | 25, 55 | KN151SP | 25, 55 | KN201SP | 25, 55 | KN222SP | 25, 55 |
| KM7 | 24, 54 | KN123WP | 25, 55 | KN151WP | 25, 55 | KN201WP | 25, 55 | KN222WP | 25, 55 |
| KM7LG | 24, 54 | KN124BP | 25, 55 | KN153BP | 25, 55 | KN202 | 25, 55 | KN223 | 25, 55 |
| KM7LR | 24, 54 | KN124SP | 25, 55 | KN153SP | 25, 55 | KN202RP | 25, 55 | KN223BP | 25, 55 |
| KM7LY | 24, 54 | KN124WP | 25, 55 | KN153WP | 25, 55 | KN203 | 25, 55 | KN223SP | 25, 55 |
| KM8 | 24, 54 | KN125BP | 25, 55 | KN154BP | 25, 55 | KN203BP | 25, 55 | KN223WP | 25, 55 |
| KMF1 | 24, 54 | KN125SP | 25, 55 | KN154SP | 25, 55 | KN203SP | 25, 55 | KN224 | 25, 55 |
| KN100AP | 26, 56 | KN125WP | 25, 55 | KN154WP | 25, 55 | KN203WP | 25, 55 | KN224BP | 25, 55 |
| KN100BP | 25, 55 | KN126BP | 25, 55 | KN155BP | 25, 55 | KN204 | 25, 55 | KN224SP | 25, 55 |
| KN100CP | 26, 56 | KN126SP | 25, 55 | KN155SP | 25, 55 | KN204RP | 25, 55 | KN224WP | 25, 55 |
| KN100GP | 26, 56 | KN126WP | 25, 55 | KN155WP | 25, 55 | KN205 | 25, 55 | KN225 | 25, 55 |
| KN100HP | 26, 56 | KN127BP | 25, 55 | KN156BP | 25, 55 | KN205RP | 25, 55 | KN225BP | 25, 55 |
| KN100LP | 26, 56 | KN127SP | 25, 55 | KN156SP | 25, 55 | KN206 | 25, 55 | KN225SP | 25, 55 |
| KN100RP | 25, 55 | KN127WP | 25, 55 | KN156WP | 25, 55 | KN206BP | 25, 55 | KN225WP | 25, 55 |
| KN100SP | 25, 55 | KN128BP | 25, 55 | KN158BP | 25, 55 | KN206SP | 25, 55 | KN226 | 25, 55 |
| KN100WP | 25, 55 | KN128SP | 25, 55 | KN158SP | 25, 55 | KN206WP | 25, 55 | KN226BP | 25, 55 |
| KN100YP | 26, 56 | KN128WP | 25, 55 | KN158WP | 25, 55 | KN207 | 25, 55 | KN226SP | 25, 55 |

Harmony™ 9001K/SK/KX 30 mm push buttons

| | | | | | | | | | |
|---------|--------|---------|--------|---------|----------------|---------|----------------|---------|--------|
| KN226WP | 25, 55 | KN247BP | 25, 55 | KN299 | 26, 56 | KN377 | 25 | KN717BP | 25, 55 |
| KN227 | 25, 55 | KN247SP | 25, 55 | KN299AP | 26, 56 | KN378 | 25 | KN717SP | 25, 55 |
| KN227BP | 25, 55 | KN247WP | 25, 55 | KN299BP | 26, 56 | KN379 | 25, 55 | KN717WP | 25, 55 |
| KN227SP | 25, 55 | KN248 | 25, 55 | KN299CP | 26, 56 | KN399 | 26, 56 | KN718BP | 25, 55 |
| KN227WP | 25, 55 | KN248BP | 25, 55 | KN299GP | 26, 56 | KN399R | 26, 56 | KN718SP | 25, 55 |
| KN228 | 25, 55 | KN248SP | 25, 55 | KN299HP | 26, 56 | KN4 | 21, 26, 51, 56 | KN718WP | 25, 55 |
| KN228BP | 25, 55 | KN248WP | 25, 55 | KN299LP | 26, 56 | KN400 | 26, 56 | KN719BP | 25, 55 |
| KN228SP | 25, 55 | KN250 | 25, 55 | KN299R | 26, 56 | KN499 | 26, 56 | KN719SP | 25, 55 |
| KN228WP | 25, 55 | KN250BP | 25, 55 | KN299RP | 26, 56 | KN5 | 21, 26, 51, 56 | KN719WP | 25, 55 |
| KN229 | 25, 55 | KN250SP | 25, 55 | KN299SP | 26, 56 | KN500 | 26, 56 | KN720BP | 25, 55 |
| KN229BP | 25, 55 | KN250WP | 25, 55 | KN299WP | 26, 56 | KN501 | 26, 56 | KN720SP | 25, 55 |
| KN229SP | 25, 55 | KN251 | 25, 55 | KN299YP | 26, 56 | KN502 | 26, 56 | KN720WP | 25, 55 |
| KN229WP | 25, 55 | KN251BP | 25, 55 | KN3 | 21, 26, 51, 56 | KN519 | 26, 56 | KN721BP | 25, 55 |
| KN230 | 25, 55 | KN251SP | 25, 55 | KN300 | 25, 55 | KN520 | 26, 56 | KN721SP | 25, 55 |
| KN230BP | 25, 55 | KN251WP | 25, 55 | KN300R | 25, 55 | KN521 | 26, 56 | KN721WP | 25, 55 |
| KN230SP | 25, 55 | KN253 | 25, 55 | KN301 | 25, 55 | KN522 | 26, 56 | KN722BP | 25, 55 |
| KN230WP | 25, 55 | KN253BP | 25, 55 | KN302 | 25, 55 | KN523 | 26, 56 | KN722SP | 25, 55 |
| KN231 | 25, 55 | KN253SP | 25, 55 | KN303 | 25, 55 | KN524 | 26, 56 | KN722WP | 25, 55 |
| KN231BP | 25, 55 | KN253WP | 25, 55 | KN304 | 25, 55 | KN525 | 26, 56 | KN723BP | 25, 55 |
| KN231SP | 25, 55 | KN254 | 25, 55 | KN305 | 25, 55 | KN526 | 26, 56 | KN723SP | 25, 55 |
| KN231WP | 25, 55 | KN254BP | 25, 55 | KN306 | 25, 55 | KN599 | 26, 56 | KN723WP | 25, 55 |
| KN232 | 25, 55 | KN254SP | 25, 55 | KN307 | 25, 55 | KN6 | 21, 26, 51, 56 | KN724BP | 25, 55 |
| KN232BP | 25, 55 | KN254WP | 25, 55 | KN308 | 25, 55 | KN600 | 26, 56 | KN724SP | 25, 55 |
| KN232SP | 25, 55 | KN255 | 25, 55 | KN309 | 25, 55 | KN600R | 26, 56 | KN724WP | 25, 55 |
| KN232WP | 25, 55 | KN255BP | 25, 55 | KN310 | 25, 55 | KN699 | 26, 56 | KN725BP | 25, 55 |
| KN233 | 25, 55 | KN255SP | 25, 55 | KN311 | 25, 55 | KN699R | 26, 56 | KN725SP | 25, 55 |
| KN233BP | 25, 55 | KN255WP | 25, 55 | KN312 | 25, 55 | KN700AP | 26, 56 | KN725WP | 25, 55 |
| KN233SP | 25, 55 | KN256 | 25, 55 | KN313 | 25, 55 | KN700BP | 26, 55 | KN726BP | 25, 55 |
| KN233WP | 25, 55 | KN256BP | 25, 55 | KN314 | 25, 55 | KN700CP | 26, 56 | KN726SP | 25, 55 |
| KN234 | 25, 55 | KN256SP | 25, 55 | KN315 | 25, 55 | KN700GP | 26, 56 | KN726WP | 25, 55 |
| KN234BP | 25, 55 | KN256WP | 25, 55 | KN316 | 25, 55 | KN700HP | 26, 56 | KN727BP | 25, 55 |
| KN234SP | 25, 55 | KN258 | 25, 55 | KN317 | 25, 55 | KN700LP | 26, 56 | KN727SP | 25, 55 |
| KN234WP | 25, 55 | KN258BP | 25, 55 | KN318 | 25, 55 | KN700RP | 25, 55 | KN727WP | 25, 55 |
| KN236 | 25, 55 | KN258SP | 25, 55 | KN319 | 25, 55 | KN700SP | 25, 55 | KN728BP | 25, 55 |
| KN236BP | 25, 55 | KN258WP | 25, 55 | KN320 | 25, 55 | KN700WP | 25, 55 | KN728SP | 25, 55 |
| KN236SP | 25, 55 | KN259 | 25, 55 | KN321 | 25, 55 | KN700YP | 26, 56 | KN728WP | 25, 55 |
| KN236WP | 25, 55 | KN259BP | 25, 55 | KN322 | 25, 55 | KN701BP | 25, 55 | KN729BP | 25, 55 |
| KN237 | 25, 55 | KN259SP | 25, 55 | KN323 | 25, 55 | KN701SP | 25, 55 | KN729SP | 25, 55 |
| KN237BP | 25, 55 | KN259WP | 25, 55 | KN324 | 25, 55 | KN701WP | 25, 55 | KN729WP | 25, 55 |
| KN237SP | 25, 55 | KN260 | 25, 55 | KN325 | 25, 55 | KN702RP | 25, 55 | KN730BP | 25, 55 |
| KN237WP | 25, 55 | KN260BP | 25, 55 | KN326 | 25, 55 | KN703BP | 25, 55 | KN730SP | 25, 55 |
| KN238 | 25, 55 | KN260SP | 25, 55 | KN327 | 25, 55 | KN703SP | 25, 55 | KN730WP | 25, 55 |
| KN238BP | 25, 55 | KN260WP | 25, 55 | KN328 | 25, 55 | KN703WP | 25, 55 | KN731BP | 25, 55 |
| KN238SP | 25, 55 | KN262 | 25, 55 | KN329 | 25, 55 | KN704RP | 25, 55 | KN731SP | 25, 55 |
| KN238WP | 25, 55 | KN262BP | 25, 55 | KN330 | 25, 55 | KN705RP | 25, 55 | KN731WP | 25, 55 |
| KN239 | 25, 55 | KN262SP | 25, 55 | KN331 | 25, 55 | KN706BP | 25, 55 | KN732BP | 25, 55 |
| KN239BP | 25, 55 | KN262WP | 25, 55 | KN332 | 25, 55 | KN706SP | 25, 55 | KN732SP | 25, 55 |
| KN239SP | 25, 55 | KN263 | 25, 55 | KN333 | 25, 55 | KN706WP | 25, 55 | KN732WP | 25, 55 |
| KN239WP | 25, 55 | KN263BP | 25, 55 | KN334 | 25, 55 | KN707BP | 25, 55 | KN733BP | 25, 55 |
| KN240 | 25, 55 | KN263SP | 25, 55 | KN336 | 25, 55 | KN707SP | 25, 55 | KN733SP | 25, 55 |
| KN240BP | 25, 55 | KN263WP | 25, 55 | KN337 | 25, 55 | KN707WP | 25, 55 | KN733WP | 25, 55 |
| KN240SP | 25, 55 | KN264 | 25, 55 | KN338 | 25, 55 | KN708BP | 25, 55 | KN734BP | 25, 55 |
| KN240WP | 25, 55 | KN264BP | 25, 55 | KN339 | 25, 55 | KN708SP | 25, 55 | KN734SP | 25, 55 |
| KN241 | 25, 55 | KN264SP | 25, 55 | KN340 | 25, 55 | KN708WP | 25, 55 | KN734WP | 25, 55 |
| KN241BP | 25, 55 | KN264WP | 25, 55 | KN341 | 25, 55 | KN709BP | 25, 55 | KN736BP | 25, 55 |
| KN241SP | 25, 55 | KN265 | 25, 55 | KN342 | 25, 55 | KN709SP | 25, 55 | KN736SP | 25, 55 |
| KN241WP | 25, 55 | KN265BP | 25, 55 | KN343 | 25, 55 | KN709WP | 25, 55 | KN736WP | 25, 55 |
| KN242 | 25, 55 | KN265SP | 25, 55 | KN344 | 25, 55 | KN710BP | 25, 55 | KN737BP | 25, 55 |
| KN242BP | 25, 55 | KN265WP | 25, 55 | KN345 | 25, 55 | KN710SP | 25, 55 | KN737SP | 25, 55 |
| KN242SP | 25, 55 | KN267 | 25, 55 | KN346 | 25, 55 | KN710WP | 25, 55 | KN737WP | 25, 55 |
| KN242WP | 25, 55 | KN267BP | 25, 55 | KN347 | 25, 55 | KN711BP | 25, 55 | KN738BP | 25, 55 |
| KN243 | 25, 55 | KN267SP | 25, 55 | KN348 | 25, 55 | KN711SP | 25, 55 | KN738SP | 25, 55 |
| KN243BP | 25, 55 | KN267WP | 25, 55 | KN350 | 25, 55 | KN711WP | 25, 55 | KN738WP | 25, 55 |
| KN243SP | 25, 55 | KN270 | 25, 55 | KN351 | 25, 55 | KN712BP | 25, 55 | KN739BP | 25, 55 |
| KN243WP | 25, 55 | KN270BP | 25, 55 | KN353 | 25, 55 | KN712SP | 25, 55 | KN739SP | 25, 55 |
| KN244 | 25, 55 | KN270SP | 25, 55 | KN354 | 25, 55 | KN712WP | 25, 55 | KN739WP | 25, 55 |
| KN244BP | 25, 55 | KN270WP | 25, 55 | KN355 | 25, 55 | KN713BP | 25, 55 | KN740BP | 25, 55 |
| KN244SP | 25, 55 | KN276 | 25, 55 | KN356 | 25, 55 | KN713SP | 25, 55 | KN740SP | 25, 55 |
| KN244WP | 25, 55 | KN276BP | 25, 55 | KN358 | 25, 55 | KN713WP | 25, 55 | KN740WP | 25, 55 |
| KN245 | 25, 55 | KN276SP | 25, 55 | KN359 | 25, 55 | KN714BP | 25, 55 | KN741BP | 25, 55 |
| KN245BP | 25, 55 | KN276WP | 25, 55 | KN360 | 25, 55 | KN714SP | 25, 55 | KN741SP | 25, 55 |
| KN245SP | 25, 55 | KN277 | 25 | KN362 | 25, 55 | KN714WP | 25, 55 | KN741WP | 25, 55 |
| KN245WP | 25, 55 | KN277BP | 55 | KN363 | 25, 55 | KN715BP | 25, 55 | KN742BP | 25, 55 |
| KN246 | 25, 55 | KN277SP | 55 | KN364 | 25, 55 | KN715SP | 25, 55 | KN742SP | 25, 55 |
| KN246BP | 25, 55 | KN277WP | 55 | KN365 | 25, 55 | KN715WP | 25, 55 | KN742WP | 25, 55 |
| KN246SP | 25, 55 | KN278BP | 25 | KN367 | 25, 55 | KN716BP | 25, 55 | KN743BP | 25, 55 |
| KN246WP | 25, 55 | KN278SP | 25 | KN370 | 25, 55 | KN716SP | 25, 55 | KN743SP | 25, 55 |
| KN247 | 25, 55 | KN278WP | 25 | KN376 | 25, 55 | KN716WP | 25, 55 | KN743WP | 25, 55 |

Harmony™ 9001K/SK/KX

30 mm push buttons

| | | | | | | | | | |
|---------|--------|---------|--------|-----------|----|----------|----|-----------|----|
| KN744BP | 25, 55 | KN799SP | 26, 56 | KP● | 17 | KR24BH13 | 10 | KR4G | 10 |
| KN744SP | 25, 55 | KN799WP | 26, 56 | KP●● | 17 | KR24BH5 | 10 | KR4GH13 | 10 |
| KN744WP | 25, 55 | KN799YP | 26, 56 | KP●G31 | 17 | KR24BH6 | 10 | KR4GH5 | 10 |
| KN745BP | 25, 55 | KN800 | 25, 55 | KP●R31 | 17 | KR24BM | 10 | KR4GH6 | 10 |
| KN745SP | 25, 55 | KN800R | 25, 55 | KP1 | 17 | KR24G | 10 | KR4R | 10 |
| KN745WP | 25, 55 | KN801 | 25, 55 | KP1● | 17 | KR24GH13 | 10 | KR4R05 | 10 |
| KN746BP | 25, 55 | KN802 | 25, 55 | KP1G31 | 17 | KR24GH5 | 10 | KR4R05H13 | 10 |
| KN746SP | 25, 55 | KN803 | 25, 55 | KP1R31 | 17 | KR24GH6 | 10 | KR4R05H5 | 10 |
| KN746WP | 25, 55 | KN804 | 25, 55 | KP35 | 17 | KR24GM | 10 | KR4R05H6 | 10 |
| KN747BP | 25, 55 | KN805 | 25, 55 | KP35● | 17 | KR24R | 10 | KR4RH13 | 10 |
| KN747SP | 25, 55 | KN806 | 25, 55 | KP35G31 | 17 | KR24RH13 | 10 | KR4RH5 | 10 |
| KN747WP | 25, 55 | KN807 | 25, 55 | KP35R31 | 17 | KR24RH5 | 10 | KR4RH6 | 10 |
| KN748BP | 25, 55 | KN808 | 25, 55 | KP7 | 17 | KR24RH6 | 10 | KR5● | 10 |
| KN748SP | 25, 55 | KN809 | 25, 55 | KP7● | 17 | KR24RM | 10 | KR5●H13 | 10 |
| KN748WP | 25, 55 | KN810 | 25, 55 | KP7G31 | 17 | KR25● | 10 | KR5●H5 | 10 |
| KN750BP | 25, 55 | KN8100 | 26, 56 | KP7R31 | 17 | KR25●H13 | 10 | KR5●H6 | 10 |
| KN750SP | 25, 55 | KN811 | 25, 55 | KQ11 | 18 | KR25●H5 | 10 | KR5B | 10 |
| KN750WP | 25, 55 | KN812 | 25, 55 | KQ11B | 18 | KR25●H6 | 10 | KR5BH13 | 10 |
| KN751BP | 25, 55 | KN813 | 25, 55 | KQ12 | 18 | KR25B | 10 | KR5BH5 | 10 |
| KN751SP | 25, 55 | KN814 | 25, 55 | KQ12B | 18 | KR25BH13 | 10 | KR5BH6 | 10 |
| KN751WP | 25, 55 | KN815 | 25, 55 | KQ13 | 18 | KR25BH5 | 10 | KR5G | 10 |
| KN753BP | 25, 55 | KN816 | 25, 55 | KQ13B | 18 | KR25BH6 | 10 | KR5GH13 | 10 |
| KN753WP | 25, 55 | KN817 | 25, 55 | KQ14 | 18 | KR25BM | 10 | KR5GH5 | 10 |
| KN754BP | 25, 55 | KN818 | 25, 55 | KQ14B | 18 | KR25G | 10 | KR5GH6 | 10 |
| KN754SP | 25, 55 | KN819 | 25, 55 | KQ15 | 18 | KR25GH13 | 10 | KR5R | 10 |
| KN754WP | 25, 55 | KN820 | 25, 55 | KQ15B | 18 | KR25GH5 | 10 | KR5R05 | 10 |
| KN755BP | 25, 55 | KN821 | 25, 55 | KR1● | 10 | KR25GH6 | 10 | KR5R05H13 | 10 |
| KN755SP | 25, 55 | KN822 | 25, 55 | KR1●H13 | 10 | KR25GM | 10 | KR5R05H5 | 10 |
| KN755WP | 25, 55 | KN823 | 25, 55 | KR1●H5 | 10 | KR25R | 10 | KR5R05H6 | 10 |
| KN756BP | 25, 55 | KN824 | 25, 55 | KR1●H6 | 10 | KR25RH13 | 10 | KR5RH13 | 10 |
| KN756SP | 25, 55 | KN825 | 25, 55 | KR11● | 19 | KR25RH5 | 10 | KR5RH5 | 10 |
| KN756WP | 25, 55 | KN826 | 25, 55 | KR11●H1 | 19 | KR25RH6 | 10 | KR5RH6 | 10 |
| KN758BP | 25, 55 | KN827 | 25, 55 | KR11U | 19 | KR25RM | 10 | KR6 | 21 |
| KN758SP | 25, 55 | KN828 | 25, 55 | KR11UH1 | 19 | KR2B | 10 | KR6● | 19 |
| KN758WP | 25, 55 | KN829 | 25, 55 | KR12● | 19 | KR2BH13 | 10 | KR6●H37 | 19 |
| KN759BP | 25, 55 | KN830 | 25, 55 | KR12●H1H1 | 19 | KR2BH5 | 10 | KR6●H7 | 19 |
| KN759SP | 25, 55 | KN831 | 25, 55 | KR12U | 19 | KR2BH6 | 10 | KR67 | 21 |
| KN759WP | 25, 55 | KN832 | 25, 55 | KR12UH1H1 | 19 | KR2G | 10 | KR67● | 19 |
| KN760BP | 25, 55 | KN833 | 25, 55 | KR131 | 18 | KR2GH13 | 10 | KR67●H37 | 19 |
| KN760SP | 25, 55 | KN8330 | 26, 56 | KR132 | 18 | KR2GH5 | 10 | KR67●H7 | 19 |
| KN760WP | 25, 55 | KN834 | 25, 55 | KR133 | 18 | KR2GH6 | 10 | KR67GR | 19 |
| KN762BP | 25, 55 | KN836 | 25, 55 | KR137 | 18 | KR2R | 10 | KR67GRH37 | 19 |
| KN762SP | 25, 55 | KN837 | 25, 55 | KR141 | 18 | KR2RH13 | 10 | KR67GRH7 | 19 |
| KN762WP | 25, 55 | KN838 | 25, 55 | KR142 | 18 | KR2RH5 | 10 | KR67U | 19 |
| KN763BP | 25, 55 | KN839 | 25, 55 | KR143 | 18 | KR2RH6 | 10 | KR67UH37 | 19 |
| KN763SP | 25, 55 | KN840 | 25, 55 | KR147 | 18 | KR2U | 10 | KR67UH7 | 19 |
| KN763WP | 25, 55 | KN841 | 25, 55 | KR152 | 18 | KR2UH13 | 10 | KR6GR | 19 |
| KN764BP | 25, 55 | KN842 | 25, 55 | KR153 | 18 | KR2UH5 | 10 | KR6GRH37 | 19 |
| KN764SP | 25, 55 | KN843 | 25, 55 | KR16 | 12 | KR2UH6 | 10 | KR6GRH7 | 19 |
| KN764WP | 25, 55 | KN844 | 25, 55 | KR16H13 | 12 | KR3 | 21 | KR6U | 19 |
| KN765BP | 25, 55 | KN845 | 25, 55 | KR16H2 | 12 | KR3● | 10 | KR6UH37 | 19 |
| KN765SP | 25, 55 | KN846 | 25, 55 | KR1B | 10 | KR3●H13 | 10 | KR6UH7 | 19 |
| KN765WP | 25, 55 | KN847 | 25, 55 | KR1BH13 | 10 | KR3●H5 | 10 | KR7 | 21 |
| KN767BP | 25, 55 | KN848 | 25, 55 | KR1BH5 | 10 | KR3●H6 | 10 | KR7● | 19 |
| KN767SP | 25, 55 | KN850 | 25, 55 | KR1BH6 | 10 | KR3B | 10 | KR7●H37 | 19 |
| KN767WP | 25, 55 | KN851 | 25, 55 | KR1G | 10 | KR3BH13 | 10 | KR7●H7 | 19 |
| KN770BP | 25, 55 | KN853 | 25, 55 | KR1GH13 | 10 | KR3BH5 | 10 | KR7GR | 19 |
| KN770SP | 25, 55 | KN854 | 25, 55 | KR1GH5 | 10 | KR3BH6 | 10 | KR7GRH37 | 19 |
| KN770WP | 25, 55 | KN855 | 25, 55 | KR1GH6 | 10 | KR3G | 10 | KR7GRH7 | 19 |
| KN776BP | 25, 55 | KN856 | 25, 55 | KR1R | 10 | KR3GH13 | 10 | KR7U | 19 |
| KN776SP | 25, 55 | KN858 | 25, 55 | KR1RH13 | 10 | KR3GH5 | 10 | KR7UH37 | 19 |
| KN776WP | 25, 55 | KN859 | 25, 55 | KR1RH5 | 10 | KR3GH6 | 10 | KR7UH7 | 19 |
| KN777BP | 25 | KN860 | 25, 55 | KR1RH6 | 10 | KR3R | 10 | KR8 | 21 |
| KN777SP | 25 | KN862 | 25, 55 | KR1U | 10 | KR3RH13 | 10 | KR8● | 12 |
| KN777WP | 25 | KN863 | 25, 55 | KR1UH13 | 10 | KR3RH5 | 10 | KR8●H25 | 12 |
| KN778BP | 25 | KN864 | 25, 55 | KR1UH5 | 10 | KR3RH6 | 10 | KR8G | 12 |
| KN778SP | 25 | KN865 | 25, 55 | KR1UH6 | 10 | KR3U | 10 | KR8GH25 | 12 |
| KN778WP | 25 | KN867 | 25, 55 | KR2 | 21 | KR3UH13 | 10 | KR8P●● | 12 |
| KN779BP | 25, 55 | KN870 | 25, 55 | KR2● | 10 | KR3UH5 | 10 | KR8P●●H25 | 12 |
| KN779SP | 25, 55 | KN876 | 25, 55 | KR2●H13 | 10 | KR3UH6 | 10 | KR8P●RH25 | 12 |
| KN779WP | 25, 55 | KN877 | 25, 55 | KR2●H5 | 10 | KR4● | 10 | KR8P1● | 12 |
| KN799AP | 26, 56 | KN899 | 26, 56 | KR2●H6 | 10 | KR4●H13 | 10 | KR8P1●H25 | 12 |
| KN799BP | 26, 56 | KN899R | 26, 56 | KR20 | 21 | KR4●H5 | 10 | KR8P1RH25 | 12 |
| KN799CP | 26, 56 | KN900 | 26, 56 | KR24● | 10 | KR4●H6 | 10 | KR8R | 12 |
| KN799GP | 26, 56 | KN9100 | 26, 56 | KR24●H13 | 10 | KR4B | 10 | KR8RH25 | 12 |
| KN799HP | 26, 56 | KN9330 | 26, 56 | KR24●H5 | 10 | KR4BH13 | 10 | KR9 | 21 |
| KN799LP | 26, 56 | KN999 | 26, 56 | KR24●H6 | 10 | KR4BH5 | 10 | KR9● | 12 |
| KN799RP | 26, 56 | KP | 21 | KR24B | 10 | KR4BH6 | 10 | KR9●H13 | 12 |

Harmony™ 9001K/SK/KX 30 mm push buttons

| | | | | | | | | | |
|-----------|----|----------|----|----------|--------|----------|----|---------|----|
| KR9BM94 | 12 | KS47 | 14 | KS73 | 14 | KXAG4 | 75 | KXN211V | 74 |
| KR9BM95 | 12 | KS47● | 14 | KS73● | 14 | KXAG5 | 75 | KXN218 | 74 |
| KR9G | 12 | KS47BH1 | 14 | KS73K● | 14 | KXAG8 | 75 | KXN218V | 74 |
| KR9GH13 | 12 | KS47BH13 | 14 | KS74 | 14 | KXAGM1 | 75 | KXN223 | 74 |
| KR9GM94 | 12 | KS47BH2 | 14 | KS74● | 14 | KXAK40B | 75 | KXN223V | 74 |
| KR9GM95 | 12 | KS47K● | 14 | KS74K● | 14 | KXAK40R | 75 | KXN224 | 74 |
| KR9P●● | 12 | KS49 | 14 | KS75 | 14 | KXAK41B | 75 | KXN224V | 74 |
| KR9P●●H13 | 12 | KS49● | 14 | KS75● | 14 | KXAK41R | 75 | KXN232 | 74 |
| KR9P●RH13 | 12 | KS49BH1 | 14 | KS75K● | 14 | KXAK52 | 75 | KXN232V | 74 |
| KR9P1● | 12 | KS49BH13 | 14 | KS76 | 14 | KXAKU17B | 75 | KXN236 | 74 |
| KR9P1●H13 | 12 | KS49BH2 | 14 | KS76● | 14 | KXAKU7 | 75 | KXN236V | 74 |
| KR9P1RH13 | 12 | KS49K● | 14 | KS76K● | 14 | KXAL1 | 75 | KXN238 | 74 |
| KR9R | 12 | KS5 | 21 | KS77 | 14 | KXAL2 | 75 | KXN238V | 74 |
| KR9R94 | 12 | KS501 | 14 | KS77● | 14 | KXAL3 | 75 | KXN299 | 74 |
| KR9R94H13 | 12 | KS501● | 14 | KS77K● | 14 | KXAL4 | 75 | KXN299V | 74 |
| KR9RH13 | 12 | KS501K● | 14 | KS79 | 14 | KXAL5 | 75 | KXN300 | 74 |
| KR9RM94 | 12 | KS502 | 14 | KS79● | 14 | KXAL8 | 75 | KXN301 | 74 |
| KR9RM95 | 12 | KS502● | 14 | KS79K● | 14 | KXALLRT | 75 | KXN302 | 74 |
| KRD1UH1 | 19 | KS502K● | 14 | KS88 | 15 | KXALM1 | 75 | KXN303 | 74 |
| KRD1UH2 | 19 | KS52 | 14 | KS88● | 15 | KXAR1 | 75 | KXN304 | 74 |
| KRD2UH1 | 19 | KS52● | 14 | KS88J●● | 15 | KXAR2 | 75 | KXN305 | 74 |
| KRD2UH2 | 19 | KS52K● | 14 | KS88J1 | 15 | KXAR3 | 75 | KXN306 | 74 |
| KRD3UH1 | 19 | KS53 | 14 | KS88J1R | 15 | KXAR4 | 75 | KXN307 | 74 |
| KRD3UH2 | 19 | KS53● | 14 | KS88K● | 15 | KXAR5 | 75 | KXN308 | 74 |
| KS11 | 13 | KS53K● | 14 | KT● | 17 | KXAR8 | 75 | KXN309 | 74 |
| KS11BH1 | 13 | KS54 | 14 | KT●● | 17 | KXARM1 | 75 | KXN310 | 74 |
| KS11BH13 | 13 | KS54● | 14 | KT●G31 | 17 | KXAW1 | 75 | KXN311 | 74 |
| KS11BH2 | 13 | KS54K● | 14 | KT●R31 | 17 | KXAW2 | 75 | KXN318 | 74 |
| KS11K | 13 | KS55 | 14 | KT1 | 17 | KXAW3 | 75 | KXN323 | 74 |
| KS12 | 13 | KS55● | 14 | KT1● | 17 | KXAW4 | 75 | KXN324 | 74 |
| KS12K | 13 | KS55K● | 14 | KT1G31 | 17 | KXAW5 | 75 | KXN332 | 74 |
| KS25 | 13 | KS56 | 14 | KT1R31 | 17 | KXAW8 | 75 | KXN336 | 74 |
| KS25K2● | 13 | KS56● | 14 | KT35 | 17 | KXAWM1 | 75 | KXN338 | 74 |
| KS34 | 13 | KS56K● | 14 | KT35● | 17 | KXBB06 | 72 | KXN399 | 74 |
| KS34K1 | 13 | KS57 | 14 | KT35G31 | 17 | KXBB07 | 72 | KXN400 | 74 |
| KS4 | 21 | KS57● | 14 | KT35R31 | 17 | KXBB08 | 72 | KXN401 | 74 |
| KS401 | 14 | KS57K● | 14 | KT7 | 17 | KXBD83 | 72 | KXN402 | 74 |
| KS401● | 14 | KS59 | 14 | KT7● | 17 | KXN100 | 74 | KXN403 | 74 |
| KS401BH1 | 14 | KS59● | 14 | KT7G31 | 17 | KXN101 | 74 | KXN404 | 74 |
| KS401BH13 | 14 | KS59K● | 14 | KT7R31 | 17 | KXN102 | 74 | KXN405 | 74 |
| KS401BH2 | 14 | KS6 | 21 | KTR● | 17 | KXN103 | 74 | KXN406 | 74 |
| KS401K● | 14 | KS601 | 14 | KTR●● | 17 | KXN104 | 74 | KXN407 | 74 |
| KS402 | 14 | KS601● | 14 | KTR●G31 | 17 | KXN105 | 74 | KXN408 | 74 |
| KS402● | 14 | KS601K● | 14 | KTR●R31 | 17 | KXN106 | 74 | KXN409 | 74 |
| KS402BH1 | 14 | KS602 | 14 | KTR35 | 17 | KXN107 | 74 | KXN410 | 74 |
| KS402BH13 | 14 | KS602● | 14 | KTR35● | 17 | KXN108 | 74 | KXN411 | 74 |
| KS402BH2 | 14 | KS602K● | 14 | KTR35G31 | 17 | KXN109 | 74 | KXN418 | 74 |
| KS402K● | 14 | KS62 | 14 | KTR35R31 | 17 | KXN110 | 74 | KXN423 | 74 |
| KS42 | 14 | KS62● | 14 | KTR38 | 17 | KXN111 | 74 | KXN424 | 74 |
| KS42● | 14 | KS62K● | 14 | KTR38● | 17 | KXN118 | 74 | KXN432 | 74 |
| KS42BH1 | 14 | KS63 | 14 | KTR38G31 | 17 | KXN123 | 74 | KXN436 | 74 |
| KS42BH13 | 14 | KS63● | 14 | KTR38R31 | 17 | KXN124 | 74 | KXN438 | 74 |
| KS42BH2 | 14 | KS63K● | 14 | KU1 | 27 | KXN132 | 74 | KXN499 | 74 |
| KS42K● | 14 | KS64 | 14 | KU17 | 27, 57 | KXN136 | 74 | KXN500 | 74 |
| KS43 | 14 | KS64● | 14 | KU18 | 27, 57 | KXN138 | 74 | KXN501 | 74 |
| KS43● | 14 | KS64K● | 14 | KU2 | 27 | KXN199 | 74 | KXN502 | 74 |
| KS43BH1 | 14 | KS65 | 14 | KU27 | 27, 57 | KXN200 | 74 | KXN503 | 74 |
| KS43BH13 | 14 | KS65● | 14 | KU3 | 27 | KXN201 | 74 | KXN504 | 74 |
| KS43BH2 | 14 | KS65K● | 14 | KU37 | 27, 57 | KXN201V | 74 | KXN505 | 74 |
| KS43K● | 14 | KS66 | 14 | KU4 | 27 | KXN202 | 74 | KXN506 | 74 |
| KS44 | 14 | KS66● | 14 | KU47 | 27, 57 | KXN202V | 74 | KXN507 | 74 |
| KS44● | 14 | KS66K● | 14 | KU5 | 27 | KXN203 | 74 | KXN508 | 74 |
| KS44BH1 | 14 | KS67 | 14 | KU6 | 27 | KXN203V | 74 | KXN509 | 74 |
| KS44BH13 | 14 | KS67● | 14 | KU7 | 27 | KXN204 | 74 | KXN510 | 74 |
| KS44BH2 | 14 | KS67K● | 14 | KU8 | 27 | KXN204V | 74 | KXN511 | 74 |
| KS44K● | 14 | KS69 | 14 | KX | | KXN205 | 74 | KXN518 | 74 |
| KS45 | 14 | KS69● | 14 | KXAA1 | 75 | KXN205V | 74 | KXN523 | 74 |
| KS45● | 14 | KS69K● | 14 | KXAA2 | 75 | KXN206 | 74 | KXN524 | 74 |
| KS45BH1 | 14 | KS7 | 21 | KXAA3 | 75 | KXN206V | 74 | KXN532 | 74 |
| KS45BH13 | 14 | KS701 | 14 | KXAA4 | 75 | KXN207 | 74 | KXN536 | 74 |
| KS45BH2 | 14 | KS701● | 14 | KXAA5 | 75 | KXN207V | 74 | KXN538 | 74 |
| KS45K● | 14 | KS701K● | 14 | KXAA8 | 75 | KXN208 | 74 | KXN599 | 74 |
| KS46 | 14 | KS702 | 14 | KXAAAM1 | 75 | KXN208V | 74 | KXN600 | 74 |
| KS46● | 14 | KS702● | 14 | KXAC28 | 75 | KXN209 | 74 | KXN639 | 74 |
| KS46BH1 | 14 | KS702K● | 14 | KXAC48 | 75 | KXN209V | 74 | KXN640 | 74 |
| KS46BH13 | 14 | KS72 | 14 | KXAG1 | 75 | KXN210 | 74 | KXN643 | 74 |
| KS46BH2 | 14 | KS72● | 14 | KXAG2 | 75 | KXN210V | 74 | KXN644 | 74 |
| KS46K● | 14 | KS72K● | 14 | KXAG3 | 75 | KXN211 | 74 | KXN645 | 74 |

Harmony™ 9001K/SK/KX

30 mm push buttons

| | | | | | | | | | |
|------------|----|---------------|--------|--------------|----|----------|----|------------|----|
| KXN646 | 74 | KXRG117 | 70 | SK1L | 51 | SK46J1R | 45 | SK75J1 | 45 |
| KXN651 | 74 | KXRG137 | 70 | SK1L● | 42 | SK47J●● | 45 | SK75J1R | 45 |
| KXN658 | 74 | KXRG35GWG | 71 | SK1L●GH13 | 42 | SK47J1 | 45 | SK76J●● | 45 |
| KXN660 | 74 | KXRG35RWG | 71 | SK1L●RH13 | 42 | SK47J1R | 45 | SK76J1 | 45 |
| KXN662 | 74 | KXRG38GWG | 71 | SK1L1 | 42 | SK49 | 59 | SK76J1R | 45 |
| KXN699 | 74 | KXRG38RWG | 71 | SK1L1GH13 | 42 | SK49J●● | 45 | SK77J●● | 45 |
| KXN700 | 74 | KXRH354GWG | 71 | SK1L1RH13 | 42 | SK49J1 | 45 | SK77J1 | 45 |
| KXN739 | 74 | KXRH35RWG | 71 | SK1L35 | 42 | SK49J1R | 45 | SK77J1R | 45 |
| KXN740 | 74 | KXRH38GWG | 71 | SK1L35GH13 | 42 | SK501J●● | 45 | SK79J●● | 45 |
| KXN743 | 74 | KXRH38RWG | 71 | SK1L35RH13 | 42 | SK501J1 | 45 | SK79J1 | 45 |
| KXN744 | 74 | KXRJ119 | 70 | SK1L7 | 42 | SK501J1R | 45 | SK79J1R | 45 |
| KXN745 | 74 | KXRJ35GWG | 71 | SK1L7GH13 | 42 | SK502J●● | 45 | SK88J●● | 46 |
| KXN746 | 74 | KXRJ35RWG | 71 | SK1L7RH13 | 42 | SK502J1 | 45 | SK88J1 | 46 |
| KXN751 | 74 | KXRJ38GWG | 71 | SK20 | 46 | SK502J1R | 45 | SK88J1R | 46 |
| KXN758 | 74 | KXRJ38RWG | 71 | SK21 | 46 | SK52J●● | 45 | SKP | 51 |
| KXN760 | 74 | KXRL121 | 70 | SK22 | 46 | SK52J1 | 45 | SKP● | 48 |
| KXN762 | 74 | KXRL138 | 70 | SK23 | 46 | SK52J1R | 45 | SKP●● | 48 |
| KXN799 | 74 | KXRL34GRGRH2 | 70 | SK25J●● | 44 | SK53J●● | 45 | SKP●G31 | 48 |
| KXPA1A | 73 | KXRL34GRGRH37 | 70 | SK25J1 | 44 | SK53J1 | 45 | SKP●R31 | 48 |
| KXPA1G | 73 | KXRL35GGRR | 71 | SK25J1R | 44 | SK53J1R | 45 | SKP1 | 48 |
| KXPA1R | 73 | KXRL35RWWG | 71 | SK2L | 51 | SK54J●● | 45 | SKP1● | 48 |
| KXPA1W | 73 | KXRL38GGRR | 71 | SK2L● | 42 | SK54J1 | 45 | SKP1G31 | 48 |
| KXPA35A | 73 | KXRL38RWWG | 71 | SK2L●G20H13 | 42 | SK54J1R | 45 | SKP1R31 | 48 |
| KXPA35G | 73 | KXRM35RRGG | 71 | SK2L●G21H13 | 42 | SK55J●● | 45 | SKP35 | 48 |
| KXPA35R | 73 | KXRM35RWWG | 71 | SK2L●GH13 | 42 | SK55J1 | 45 | SKP35● | 48 |
| KXPA35W | 73 | KXRM38RRGG | 71 | SK2L●R20H13 | 42 | SK55J1R | 45 | SKP35G31 | 48 |
| KXPB1AA | 73 | KXRM38RWWG | 71 | SK2L●R21H13 | 42 | SK56J●● | 45 | SKP35R31 | 48 |
| KXPB1GG | 73 | KXSA125 | 72 | SK2L●RH13 | 42 | SK56J1 | 45 | SKP7 | 48 |
| KXPB1RG | 73 | KXSA139 | 72 | SK2L1 | 42 | SK56J1R | 45 | SKP7● | 48 |
| KXPB1RR | 73 | KXSAEB | 72 | SK2L1G20H13 | 42 | SK57J●● | 45 | SKP7G31 | 48 |
| KXPB1WW | 73 | KXSD126 | 72 | SK2L1G21H13 | 42 | SK57J1 | 45 | SKP7R31 | 48 |
| KXPB34AA | 73 | KXSDCB | 72 | SK2L1GH13 | 42 | SK57J1R | 45 | SKR1● | 41 |
| KXPB34GG | 73 | KXSHHB | 72 | SK2L1R20H13 | 42 | SK59J●● | 45 | SKR1●H13 | 41 |
| KXPB34RG | 73 | KXSJE35G | 72 | SK2L1R21H13 | 42 | SK59J1 | 45 | SKR1●H5 | 41 |
| KXPB34RR | 73 | KXSJE35R | 72 | SK2L1RH13 | 42 | SK59J1R | 45 | SKR1●H6 | 41 |
| KXPB34WW | 73 | KXSJE35W | 72 | SK2L35 | 42 | SK601J●● | 45 | SKR11● | 49 |
| KXPC1WAGR | 73 | KXSJE38G | 72 | SK2L35G20H13 | 42 | SK601J1 | 45 | SKR11●H1 | 49 |
| KXPC1WLGR | 73 | KXSJE38R | 72 | SK2L35G21H13 | 42 | SK601J1R | 45 | SKR11U | 49 |
| KXPC34WAGR | 73 | KXSJE38W | 72 | SK2L35GH13 | 42 | SK602J●● | 45 | SKR11UH1 | 49 |
| KXRA133 | 70 | KXSRE1 | 72 | SK2L35R20H13 | 42 | SK602J1 | 45 | SKR12● | 49 |
| KXRA134 | 70 | KXSRE2 | 72 | SK2L35R21H13 | 42 | SK602J1R | 45 | SKR12●H1H1 | 49 |
| KXRAA | 71 | KXSRE3 | 72 | SK2L35RH13 | 42 | SK62J●● | 45 | SKR12U | 49 |
| KXRAAH2 | 70 | KXSVC10 | 72 | SK2L7 | 42 | SK62J1 | 45 | SKR12UH1H1 | 49 |
| KXRAG | 71 | KXSVC5 | 72 | SK2L7G20H13 | 42 | SK62J1R | 45 | SKR16 | 43 |
| KXRAGH2 | 70 | L | | SK2L7G21H13 | 42 | SK63J●● | 45 | SKR16H13 | 43 |
| KXRAL | 71 | L20 | 28, 58 | SK2L7GH13 | 42 | SK63J1 | 45 | SKR16H2 | 43 |
| KXRALH2 | 70 | L21 | 28, 58 | SK2L7R20H13 | 42 | SK63J1R | 45 | SKR1B | 41 |
| KXRAR | 71 | L22 | 28, 58 | SK2L7R21H13 | 42 | SK64J●● | 45 | SKR1BH13 | 41 |
| KXRAW | 71 | L24 | 28, 58 | SK2L7RH13 | 42 | SK64J1 | 45 | SKR1BH5 | 41 |
| KXRB1AH1 | 70 | L31 | 28, 58 | SK34J●● | 44 | SK64J1R | 45 | SKR1BH6 | 41 |
| KXRB1GH1 | 70 | L6 | 28, 58 | SK34J1 | 44 | SK65J●● | 45 | SKR1G | 41 |
| KXRB1RH1 | 70 | L7 | 28, 58 | SK34J1R | 44 | SK65J1 | 45 | SKR1GH13 | 41 |
| KXRB34AH1 | 70 | L8 | 28, 58 | SK40 | 59 | SK65J1R | 45 | SKR1GH5 | 41 |
| KXRB34GH1 | 70 | L9 | 28, 58 | SK401J●● | 45 | SK66J●● | 45 | SKR1GH6 | 41 |
| KXRB34RH1 | 70 | R | | SK401J1 | 45 | SK66J1 | 45 | SKR1R | 41 |
| KXRB35A | 71 | R19 | 28, 58 | SK401J1R | 45 | SK66J1R | 45 | SKR1RH13 | 41 |
| KXRB35G | 71 | R20 | 28, 58 | SK402J●● | 45 | SK67J●● | 45 | SKR1RH5 | 41 |
| KXRB35L | 71 | R21 | 28, 58 | SK402J1 | 45 | SK67J1 | 45 | SKR1RH6 | 41 |
| KXRB35R | 71 | R22 | 28, 58 | SK402J1R | 45 | SK67J1R | 45 | SKR1U | 41 |
| KXRB35W | 71 | R2205 | 28, 58 | SK41 | 59 | SK69J●● | 45 | SKR1UH13 | 41 |
| KXRB38A | 71 | R24 | 28, 58 | SK42 | 59 | SK69J1 | 45 | SKR1UH5 | 41 |
| KXRB38G | 71 | R31 | 28, 58 | SK42J●● | 45 | SK69J1R | 45 | SKR1UH6 | 41 |
| KXRB38L | 71 | R6 | 28, 58 | SK42J1 | 45 | SK701J●● | 45 | SKR2 | 51 |
| KXRB38R | 71 | R7 | 28, 58 | SK42J1R | 45 | SK701J1 | 45 | SKR2● | 41 |
| KXRB38W | 71 | R8 | 28, 58 | SK43J●● | 45 | SK701J1R | 45 | SKR2●H5 | 41 |
| KXRC111 | 70 | R9 | 28, 58 | SK43J1 | 45 | SK702J●● | 45 | SKR2●H6 | 41 |
| KXRC136 | 70 | R94 | 28, 58 | SK43J1R | 45 | SK702J1 | 45 | SKR20 | 51 |
| KXRCGG | 71 | S | | SK44 | 59 | SK702J1R | 45 | SKR24● | 41 |
| KXRCGR | 71 | S11 | 28, 58 | SK44J●● | 45 | SK72J●● | 45 | SKR24●H13 | 41 |
| KXRCWW | 71 | S23 | 28, 58 | SK44J1 | 45 | SK72J1 | 45 | SKR24●H5 | 41 |
| KXRD140 | 70 | S25 | 28, 58 | SK44J1R | 45 | SK72J1R | 45 | SKR24●H6 | 41 |
| KXRDLLH7 | 70 | SK | | SK45 | 59 | SK73J●● | 45 | SKR24B | 41 |
| KXRE115 | 70 | SK11J●● | 44 | SK45J●● | 45 | SK73J1 | 45 | SKR24BH13 | 41 |
| KXREGG | 71 | SK11J1 | 44 | SK45J1 | 45 | SK73J1R | 45 | SKR24BH5 | 41 |
| KXREGR | 71 | SK11J1R | 44 | SK45J1R | 45 | SK74J●● | 45 | SKR24BH6 | 41 |
| KXRELLH2 | 70 | SK12J●● | 44 | SK46 | 59 | SK74J1 | 45 | SKR24G | 41 |
| KXRELLH3 | 70 | SK12J1 | 44 | SK46J●● | 45 | SK74J1R | 45 | SKR24GH13 | 41 |
| KXREWW | 71 | SK12J1R | 44 | SK46J1 | 45 | SK75J●● | 45 | SKR24GH5 | 41 |

Harmony™ 9001K/SK/KX 30 mm push buttons

| | | | | | | | |
|------------|----|------------|----|-----------|----|-----------|--------|
| SKR24GH6 | 41 | SKR5● | 41 | SKS44 | 45 | SKS77● | 45 |
| SKR24R | 41 | SKR5●H13 | 41 | SKS44● | 45 | SKS79 | 45 |
| SKR24RH13 | 41 | SKR5●H5 | 41 | SKS44BH1 | 45 | SKS79● | 45 |
| SKR24RH5 | 41 | SKR5●H6 | 41 | SKS44BH13 | 45 | SKS88 | 46 |
| SKR24RH6 | 41 | SKR5B | 41 | SKS44BH2 | 45 | SKS88● | 46 |
| SKR25● | 41 | SKR5BH13 | 41 | SKS45 | 45 | SKT● | 48 |
| SKR25●H13 | 41 | SKR5BH5 | 41 | SKS45● | 45 | SKT●● | 48 |
| SKR25●H5 | 41 | SKR5BH6 | 41 | SKS45BH1 | 45 | SKT●G31 | 48 |
| SKR25●H6 | 41 | SKR5G | 41 | SKS45BH13 | 45 | SKT●R31 | 48 |
| SKR25B | 41 | SKR5GH13 | 41 | SKS45BH2 | 45 | SKT1 | 48 |
| SKR25BH13 | 41 | SKR5GH5 | 41 | SKS46 | 45 | SKT1● | 48 |
| SKR25BH5 | 41 | SKR5GH6 | 41 | SKS46● | 45 | SKT1G31 | 48 |
| SKR25BH6 | 41 | SKR5R | 41 | SKS46BH1 | 45 | SKT1R31 | 48 |
| SKR25G | 41 | SKR5R05 | 41 | SKS46BH13 | 45 | SKT35 | 48 |
| SKR25GH13 | 41 | SKR5R05H13 | 41 | SKS47 | 45 | SKT35● | 48 |
| SKR25GH5 | 41 | SKR5R05H5 | 41 | SKS47● | 45 | SKT35G31 | 48 |
| SKR25GH6 | 41 | SKR5R05H6 | 41 | SKS47BH1 | 45 | SKT35R31 | 48 |
| SKR25R | 41 | SKR5RH13 | 41 | SKS47BH13 | 45 | SKT7 | 48 |
| SKR25RH13 | 41 | SKR5RH5 | 41 | SKS47BH2 | 45 | SKT7● | 48 |
| SKR25RH5 | 41 | SKR5RH6 | 41 | SKS49 | 45 | SKT7G31 | 48 |
| SKR25RH6 | 41 | SKR8 | 51 | SKS49● | 45 | SKT7R31 | 48 |
| SKR2B | 41 | SKR8● | 43 | SKS49BH1 | 45 | SKTR● | 48 |
| SKR2BH13 | 41 | SKR8●H25 | 43 | SKS49BH13 | 45 | SKTR●● | 48 |
| SKR2BH5 | 41 | SKR8G | 43 | SKS49BH2 | 45 | SKTR●G31 | 48 |
| SKR2BH6 | 41 | SKR8GH25 | 43 | SKS5 | 51 | SKTR●R31 | 48 |
| SKR2G | 41 | SKR8P●● | 43 | SKS501 | 45 | SKTR35 | 48 |
| SKR2GH13 | 41 | SKR8P●●H25 | 43 | SKS501● | 45 | SKTR35● | 48 |
| SKR2GH5 | 41 | SKR8P●RH25 | 43 | SKS502 | 45 | SKTR35G31 | 48 |
| SKR2GH6 | 41 | SKR8P1● | 43 | SKS502● | 45 | SKTR35R31 | 48 |
| SKR2R | 41 | SKR8P1●H25 | 43 | SKS52 | 45 | SKTR38 | 48 |
| SKR2RH13 | 41 | SKR8P1RH25 | 43 | SKS52● | 45 | SKTR38● | 48 |
| SKR2RH5 | 41 | SKR8R | 43 | SKS53 | 45 | SKTR38G31 | 48 |
| SKR2RH6 | 41 | SKR8RH25 | 43 | SKS53● | 45 | SKTR38R31 | 48 |
| SKR2U | 41 | SKR9 | 51 | SKS54 | 45 | SS | |
| SKR2UH13 | 41 | SKR9● | 43 | SKS54● | 45 | SSKS46BH2 | 45 |
| SKR2UH5 | 41 | SKR9●H13 | 43 | SKS55 | 45 | T | |
| SKR2UH6 | 41 | SKR9G | 43 | SKS55● | 45 | T5BE | 28, 58 |
| SKR3 | 51 | SKR9GH13 | 43 | SKS56 | 45 | T5BK | 28, 58 |
| SKR3● | 41 | SKR9P●● | 43 | SKS56● | 45 | T5GN | 28, 58 |
| SKR3●H13 | 41 | SKR9P●●H13 | 43 | SKS57 | 45 | T5OE | 28, 58 |
| SKR3●H5 | 41 | SKR9P●RH13 | 43 | SKS57● | 45 | T5RD | 28, 58 |
| SKR3●H6 | 41 | SKR9P1● | 43 | SKS59 | 45 | T5WH | 28, 58 |
| SKR3B | 41 | SKR9P1●H13 | 43 | SKS59● | 45 | T5YW | 28, 58 |
| SKR3BH13 | 41 | SKR9P1RH13 | 43 | SKS6 | 51 | T8BE | 28, 58 |
| SKR3BH5 | 41 | SKR9R | 43 | SKS601 | 45 | T8BK | 28, 58 |
| SKR3BH6 | 41 | SKR9RH13 | 43 | SKS601● | 45 | T8GN | 28, 58 |
| SKR3G | 41 | SKS11 | 44 | SKS602 | 45 | T8GY | 28, 58 |
| SKR3GH13 | 41 | SKS11● | 44 | SKS602● | 45 | T8OE | 28, 58 |
| SKR3GH5 | 41 | SKS11BH1 | 44 | SKS62 | 45 | T8RD | 28, 58 |
| SKR3GH6 | 41 | SKS11BH13 | 44 | SKS62● | 45 | T8U | 28, 58 |
| SKR3R | 41 | SKS11BH2 | 44 | SKS63 | 45 | T8WH | 28, 58 |
| SKR3RH13 | 41 | SKS12 | 44 | SKS63● | 45 | T8YW | 28, 58 |
| SKR3RH5 | 41 | SKS12● | 44 | SKS64 | 45 | U | |
| SKR3RH6 | 41 | SKS25 | 44 | SKS64● | 45 | U19 | 28, 58 |
| SKR3U | 41 | SKS25● | 44 | SKS65 | 45 | W | |
| SKR3UH13 | 41 | SKS34 | 44 | SKS65● | 45 | W20 | 28, 58 |
| SKR3UH5 | 41 | SKS34● | 44 | SKS66 | 45 | W21 | 28, 58 |
| SKR3UH6 | 41 | SKS4 | 51 | SKS66● | 45 | W22 | 28, 58 |
| SKR4● | 41 | SKS401 | 45 | SKS67 | 45 | W24 | 28, 58 |
| SKR4●H13 | 41 | SKS401● | 45 | SKS67● | 45 | W31 | 28, 58 |
| SKR4●H5 | 41 | SKS401BH1 | 45 | SKS69 | 45 | W6 | 28, 58 |
| SKR4●H6 | 41 | SKS401BH13 | 45 | SKS69● | 45 | W7 | 28, 58 |
| SKR4B | 41 | SKS401BH2 | 45 | SKS7 | 51 | W8 | 28, 58 |
| SKR4BH13 | 41 | SKS402 | 45 | SKS701 | 45 | W9 | 28, 58 |
| SKR4BH5 | 41 | SKS402● | 45 | SKS701● | 45 | Y | |
| SKR4BH6 | 41 | SKS402BH1 | 45 | SKS702 | 45 | Y20 | 28, 58 |
| SKR4G | 41 | SKS402BH13 | 45 | SKS702● | 45 | Y21 | 28, 58 |
| SKR4GH13 | 41 | SKS402BH2 | 45 | SKS72 | 45 | Y22 | 28, 58 |
| SKR4GH5 | 41 | SKS42 | 45 | SKS72● | 45 | Y24 | 28, 58 |
| SKR4GH6 | 41 | SKS42● | 45 | SKS73 | 45 | Y31 | 28, 58 |
| SKR4R | 41 | SKS42BH1 | 45 | SKS73● | 45 | Y6 | 28, 58 |
| SKR4R05 | 41 | SKS42BH13 | 45 | SKS74 | 45 | Y7 | 28, 58 |
| SKR4R05H13 | 41 | SKS42BH2 | 45 | SKS74● | 45 | Y8 | 28, 58 |
| SKR4R05H5 | 41 | SKS43 | 45 | SKS75 | 45 | Y9 | 28, 58 |
| SKR4R05H6 | 41 | SKS43● | 45 | SKS75● | 45 | | |
| SKR4RH13 | 41 | SKS43BH1 | 45 | SKS76 | 45 | | |
| SKR4RH5 | 41 | SKS43BH13 | 45 | SKS76● | 45 | | |
| SKR4RH6 | 41 | SKS43BH2 | 45 | SKS77 | 45 | | |

<http://www.schneider-electric.us/>

Schneider Electric USA, Inc.

8001 Knightdale Blvd.
Knightdale, NC 27545

USA Customer Care Center
Tel: 888-778-2733

Schneider Electric Canada

5985 McLaughlin Rd.
Mississauga, Ontario, Canada L5R 1B8

Canada Customer Care Center
Tel: 800-565-6699

The information and dimensions in this catalog are provided for the convenience of our customers. While this information is believed to be accurate, Schneider Electric reserves the right to make updates and changes without prior notification and assumes no liability for any errors or omissions.

Harmony, Schneider Electric and logo are trademarks or registered trademarks of Schneider Electric or its affiliates in the United States and other countries. Other trademarks used herein are the property of their respective owners.

Design: Schneider Electric
Photos: Schneider Electric



2011

Harmony™ 9001K/SK/KX 30 mm push buttons

Компания «Океан Электроники» предлагает заключение долгосрочных отношений при поставках импортных электронных компонентов на взаимовыгодных условиях!

Наши преимущества:

- Поставка оригинальных импортных электронных компонентов напрямую с производств Америки, Европы и Азии, а так же с крупнейших складов мира;
- Широкая линейка поставок активных и пассивных импортных электронных компонентов (более 30 млн. наименований);
- Поставка сложных, дефицитных, либо снятых с производства позиций;
- Оперативные сроки поставки под заказ (от 5 рабочих дней);
- Экспресс доставка в любую точку России;
- Помощь Конструкторского Отдела и консультации квалифицированных инженеров;
- Техническая поддержка проекта, помощь в подборе аналогов, поставка прототипов;
- Поставка электронных компонентов под контролем ВП;
- Система менеджмента качества сертифицирована по Международному стандарту ISO 9001;
- При необходимости вся продукция военного и аэрокосмического назначения проходит испытания и сертификацию в лаборатории (по согласованию с заказчиком);
- Поставка специализированных компонентов военного и аэрокосмического уровня качества (Xilinx, Altera, Analog Devices, Intersil, Interpoint, Microsemi, Actel, Aeroflex, Peregrine, VPT, Syfer, Eurofarad, Texas Instruments, MS Kennedy, Miteq, Cobham, E2V, MA-COM, Hittite, Mini-Circuits, General Dynamics и др.);

Компания «Океан Электроники» является официальным дистрибьютором и эксклюзивным представителем в России одного из крупнейших производителей разъемов военного и аэрокосмического назначения «JONHON», а так же официальным дистрибьютором и эксклюзивным представителем в России производителя высокотехнологичных и надежных решений для передачи СВЧ сигналов «FORSTAR».



JONHON

«JONHON» (основан в 1970 г.)

Разъемы специального, военного и аэрокосмического назначения:

(Применяются в военной, авиационной, аэрокосмической, морской, железнодорожной, горно- и нефтедобывающей отраслях промышленности)

«FORSTAR» (основан в 1998 г.)

ВЧ соединители, коаксиальные кабели, кабельные сборки и микроволновые компоненты:

(Применяются в телекоммуникациях гражданского и специального назначения, в средствах связи, РЛС, а так же военной, авиационной и аэрокосмической отраслях промышленности).



Телефон: 8 (812) 309-75-97 (многоканальный)

Факс: 8 (812) 320-03-32

Электронная почта: ocean@oceanchips.ru

Web: <http://oceanchips.ru/>

Адрес: 198099, г. Санкт-Петербург, ул. Калинина, д. 2, корп. 4, лит. А