



**MICROCHIP**

---

**MCP1630 Coupled Inductor  
Boost Converter  
Demo Board  
User's Guide**

---

**Note the following details of the code protection feature on Microchip devices:**

- Microchip products meet the specification contained in their particular Microchip Data Sheet.
- Microchip believes that its family of products is one of the most secure families of its kind on the market today, when used in the intended manner and under normal conditions.
- There are dishonest and possibly illegal methods used to breach the code protection feature. All of these methods, to our knowledge, require using the Microchip products in a manner outside the operating specifications contained in Microchip's Data Sheets. Most likely, the person doing so is engaged in theft of intellectual property.
- Microchip is willing to work with the customer who is concerned about the integrity of their code.
- Neither Microchip nor any other semiconductor manufacturer can guarantee the security of their code. Code protection does not mean that we are guaranteeing the product as "unbreakable."

Code protection is constantly evolving. We at Microchip are committed to continuously improving the code protection features of our products. Attempts to break Microchip's code protection feature may be a violation of the Digital Millennium Copyright Act. If such acts allow unauthorized access to your software or other copyrighted work, you may have a right to sue for relief under that Act.

---

Information contained in this publication regarding device applications and the like is provided only for your convenience and may be superseded by updates. It is your responsibility to ensure that your application meets with your specifications. MICROCHIP MAKES NO REPRESENTATIONS OR WARRANTIES OF ANY KIND WHETHER EXPRESS OR IMPLIED, WRITTEN OR ORAL, STATUTORY OR OTHERWISE, RELATED TO THE INFORMATION, INCLUDING BUT NOT LIMITED TO ITS CONDITION, QUALITY, PERFORMANCE, MERCHANTABILITY OR FITNESS FOR PURPOSE. Microchip disclaims all liability arising from this information and its use. Use of Microchip devices in life support and/or safety applications is entirely at the buyer's risk, and the buyer agrees to defend, indemnify and hold harmless Microchip from any and all damages, claims, suits, or expenses resulting from such use. No licenses are conveyed, implicitly or otherwise, under any Microchip intellectual property rights.

**Trademarks**

The Microchip name and logo, the Microchip logo, Accuron, dsPIC, KEELOQ, microID, MPLAB, PIC, PICmicro, PICSTART, PRO MATE, PowerSmart, rfPIC and SmartShunt are registered trademarks of Microchip Technology Incorporated in the U.S.A. and other countries.

AmpLab, FilterLab, Migratable Memory, MXDEV, MXLAB, SEEVAL, SmartSensor and The Embedded Control Solutions Company are registered trademarks of Microchip Technology Incorporated in the U.S.A.

Analog-for-the-Digital Age, Application Maestro, dsPICDEM, dsPICDEM.net, dsPICworks, ECAN, ECONOMONITOR, FanSense, FlexROM, fuzzyLAB, In-Circuit Serial Programming, ICSP, ICEPIC, Linear Active Thermistor, Mindi, MiWi, MPASM, MPLIB, MPLINK, PICKit, PICDEM, PICDEM.net, PICLAB, PICTail, PowerCal, PowerInfo, PowerMate, PowerTool, REAL ICE, rLAB, rfPICDEM, Select Mode, Smart Serial, SmartTel, Total Endurance, UNI/O, WiperLock and ZENA are trademarks of Microchip Technology Incorporated in the U.S.A. and other countries.

SQTP is a service mark of Microchip Technology Incorporated in the U.S.A.

All other trademarks mentioned herein are property of their respective companies.

© 2006, Microchip Technology Incorporated, Printed in the U.S.A., All Rights Reserved.

 Printed on recycled paper.

**QUALITY MANAGEMENT SYSTEM**  
**CERTIFIED BY DNV**  
**== ISO/TS 16949:2002 ==**

*Microchip received ISO/TS-16949:2002 certification for its worldwide headquarters, design and wafer fabrication facilities in Chandler and Tempe, Arizona, Gresham, Oregon and Mountain View, California. The Company's quality system processes and procedures are for its PICmicro® 8-bit MCUs, KEELOQ® code hopping devices, Serial EEPROMs, microperipherals, nonvolatile memory and analog products. In addition, Microchip's quality system for the design and manufacture of development systems is ISO 9001:2000 certified.*



# MCP1630 COUPLED INDUCTOR BOOST CONVERTER DEMO BOARD USER'S GUIDE

## Table of Contents

<b>Preface</b> .....	<b>1</b>
Introduction.....	1
Document Layout .....	1
Conventions Used in this Guide .....	2
Recommended Reading.....	2
The Microchip Web Site .....	3
Customer Support .....	3
Document Revision History .....	3
<b>Chapter 1. Product Overview</b> .....	<b>5</b>
1.1 Introduction .....	5
1.2 What is the MCP1630 Coupled Inductor Boost Converter Demo Board? .....	6
1.3 What The MCP1630 Coupled Inductor Boost Converter Demo Board Kit Includes .....	6
<b>Chapter 2. Installation and Operation</b> .....	<b>7</b>
2.1 Introduction .....	7
2.2 Features .....	7
2.3 Getting Started .....	8
<b>Appendix A. Schematic and Layouts</b> .....	<b>11</b>
A.1 Introduction .....	11
A.2 Board – Schematic .....	12
A.3 Board – Top Silk Layer .....	13
A.4 Board – Top Metal Layer .....	14
A.5 Board – Bottom Metal Layer .....	15
<b>Appendix B. Bill Of Materials (BOM)</b> .....	<b>17</b>
<b>Appendix C. Demo Board Firmware</b> .....	<b>19</b>
C.1 Device Firmware .....	19
<b>Worldwide Sales and Service</b> .....	<b>22</b>

# **MCP1630 Coupled Inductor Boost Converter Demo Board User's Guide**

---

---

NOTES:



# MCP1630 COUPLED INDUCTOR BOOST CONVERTER DEMO BOARD USER'S GUIDE

## Preface

### NOTICE TO CUSTOMERS

All documentation becomes dated, and this manual is no exception. Microchip tools and documentation are constantly evolving to meet customer needs, so some actual dialogs and/or tool descriptions may differ from those in this document. Please refer to our web site ([www.microchip.com](http://www.microchip.com)) to obtain the latest documentation available.

Documents are identified with a “DS” number. This number is located on the bottom of each page, in front of the page number. The numbering convention for the DS number is “DSXXXXA”, where “XXXX” is the document number and “A” is the revision level of the document.

For the most up-to-date information on development tools, see the MPLAB® IDE on-line help. Select the Help menu, and then Topics to open a list of available on-line help files.

### INTRODUCTION

This chapter contains general information that will be useful to know before using the MCP1630 Coupled Inductor Boost Converter Demo Board. Items discussed in this chapter include:

- Document Layout
- Conventions Used in this Guide
- Recommended Reading
- The Microchip Web Site
- Customer Support
- Document Revision History

### DOCUMENT LAYOUT

This document describes how to use the MCP1630 Coupled Inductor Boost Converter Demo Board. The manual layout is as follows:

- **Chapter 1. “Product Overview”** – Important information about the MCP1630 Coupled Inductor Boost Converter Demo Board.
- **Chapter 2. “Installation and Operation”** – Includes instructions on how to get started with this user’s guide and a description of the user’s guide.
- **Appendix A. “Schematic and Layouts”** – Shows the schematic and layout diagrams for the MCP1630 Coupled Inductor Boost Converter Demo Board.
- **Appendix B. “Bill Of Materials (BOM)”** – Lists the parts used to build the MCP1630 Coupled Inductor Boost Converter Demo Board.
- **Appendix C. “Demo Board Firmware”** – Provides information about the application firmware and where the source code can be found.

## CONVENTIONS USED IN THIS GUIDE

This manual uses the following documentation conventions:

### DOCUMENTATION CONVENTIONS

Description	Represents	Examples
<b>Arial font:</b>		
Italic characters	Referenced books	<i>MPLAB<sup>®</sup> IDE User's Guide</i>
	Emphasized text	...is the <i>only</i> compiler...
Initial caps	A window	the Output window
	A dialog	the Settings dialog
	A menu selection	select Enable Programmer
Quotes	A field name in a window or dialog	"Save project before build"
Underlined, italic text with right angle bracket	A menu path	<u><i>File&gt;Save</i></u>
Bold characters	A dialog button	Click <b>OK</b>
	A tab	Click the <b>Power</b> tab
'bnnnn	A binary number where <i>n</i> is a digit	'b00100, 'b10
Text in angle brackets < >	A key on the keyboard	Press <Enter>, <F1>
<b>Courier font:</b>		
Plain Courier	Sample source code	#define START
	Filenames	autoexec.bat
	File paths	c:\mcc18\h
	Keywords	_asm, _endasm, static
	Command-line options	-Opa+, -Opa-
	Bit values	0, 1
Italic Courier	A variable argument	<i>file.o</i> , where <i>file</i> can be any valid filename
0xnnnn	A hexadecimal number where <i>n</i> is a hexadecimal digit	0xFFFF, 0x007A
Square brackets [ ]	Optional arguments	mcc18 [options] <i>file</i> [options]
Curly brackets and pipe character: {   }	Choice of mutually exclusive arguments; an OR selection	errorlevel {0 1}
Ellipses...	Replaces repeated text	var_name [, var_name...]
	Represents code supplied by user	void main (void) { ... }

## RECOMMENDED READING

The following Microchip documents are available and recommended as supplemental reference resources:

### **MCP1630/MCP1630V Data Sheet, "High-Speed, Microcontroller-Adaptable, Pulse Width Modulator" (DS21896)**

This data sheet provides detailed information regarding the MCP1630/MCP1630V product family.

### **PIC12F683 Data Sheet, "8-Pin Flash-Based, 8-Bit CMOS Microcontrollers with Nano Watt Technology" (DS41211)**

This data sheet provides detailed information regarding the PIC12F683 product family.

## THE MICROCHIP WEB SITE

Microchip provides online support via our web site at [www.microchip.com](http://www.microchip.com). This web site is used as a means to make files and information easily available to customers. Accessible by using your favorite Internet browser, the web site contains the following information:

- **Product Support** – Data sheets and errata, application notes and sample programs, design resources, user's guides and hardware support documents, latest software releases and archived software
- **General Technical Support** – Frequently Asked Questions (FAQs), technical support requests, online discussion groups, Microchip consultant program member listing
- **Business of Microchip** – Product selector and ordering guides, latest Microchip press releases, listing of seminars and events, listings of Microchip sales offices, distributors and factory representatives

## CUSTOMER SUPPORT

Users of Microchip products can receive assistance through several channels:

- Distributor or Representative
- Local Sales Office
- Field Application Engineer (FAE)
- Technical Support
- Development Systems Information Line

Customers should contact their distributor, representative or field application engineer for support. Local sales offices are also available to help customers. A listing of sales offices and locations is included in the back of this document.

Technical support is available through the web site at: <http://support.microchip.com>.

In addition, there is a Development Systems Information Line which lists the latest versions of Microchip's development systems software products. This line also provides information on how customers can receive currently available upgrade kits.

The Development Systems Information Line numbers are:

1-800-755-2345 – United States and most of Canada

1-480-792-7302 – Other International Locations

## DOCUMENT REVISION HISTORY

### Revision A (June 2006)

- Initial Release of this Document.

# **MCP1630 Coupled Inductor Boost Converter Demo Board User's Guide**

---

---

NOTES:





# MCP1630 COUPLED INDUCTOR BOOST CONVERTER DEMO BOARD USER'S GUIDE

## Chapter 1. Product Overview

### 1.1 INTRODUCTION

In certain applications, a higher output voltage is required that needs to be driven from a lower Input voltage (i.e., 3V). The selection of switching device for these applications is faced with certain problems which are listed below.

- The high voltage MOSFET's generally do not operate with a low 3V gate drive
- The larger drain-source capacitance of high-voltage MOSFET's requires energy in the inductor to slew drain to output voltage, thus resulting in a loss in efficiency
- The high voltage MOSFET's with low gate drive voltage are a rare commodity compared to their lower voltage counterparts. For example, a high voltage MOSFET of 40V to 60V is generally available with a gate drive voltage of 5-10V, whereas, it's difficult to locate a high voltage MOSFET of 40V to 60V with a lower gate drive of 3V. Also, high voltage MOSFET's are large and more expensive than their low voltage counterparts

The MCP1630 Coupled Inductor Boost Converter Demo Board reduces the drain-to-source voltage on the main boost converter switch. This allows the use of low gate threshold voltage switches for high voltage output boost applications.

The MCP1630 is a high-speed, microcontroller-adaptable, Pulse Width Modulator (PWM). A coupled Inductor boost design with an MCP1630 device provides a viable solution for obtaining high output voltages with low gate drive voltage.

This chapter covers the following topics.

- What is the MCP1630 Coupled Inductor Boost Converter Demo Board?
- What the MCP1630 Coupled Inductor Boost Converter Demo Board Kit includes

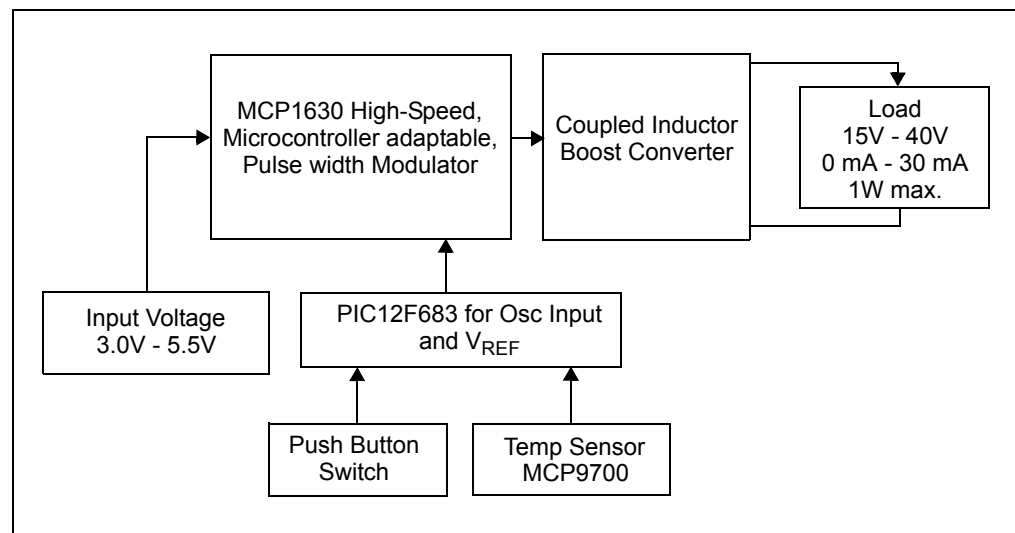

**FIGURE 1-1:** MCP1630 Coupled Inductor Boost Converter Demo Board Block Diagram.

## 1.2 WHAT IS THE MCP1630 COUPLED INDUCTOR BOOST CONVERTER DEMO BOARD?

The MCP1630 Coupled Inductor Boost Converter Demo Board demonstrates the use of a conventional boost topology with a coupled inductor. The center of the coupled inductor tap is connected to the Boost switch. The voltage stress on the MOSFET is reduced because the coupled inductor acts as a step-down auto transformer that reduces the reflection of output voltage which the MOSFET encounters. The voltage on the switching node is equal to the output voltage divided by the turn's ratio. The coupled inductor with a turn's ratio 1:1 will reduce the stress on the Boost switch to one-half. The demo board also serves as a platform to evaluate the MCP1630 device.

The inputs of the MCP1630 device are easily attached to the I/O pins of an MCU. The MCU supplies the oscillator pulses and reference voltage to the MCP1630 device to provide the most flexible and adaptable power system. The power system switching frequency and maximum duty cycle are set using the I/O pins of the MCU. The reference input can be external, a Digital-to-Analog Converter (DAC) output or as simple as an I/O output from the MCU. This enables the power system to adapt to many external signals and variables in order to optimize performance and facilitate calibration.

The MCP1630 device demonstrates the use of Microchip's high-speed microcontroller-adaptable PWM integrated with the PIC12F683 (Flash MCU SOIC8) in coupled inductor applications. Under normal operation, the supply ranges between 3.0V - 5.5V. The output voltage can be varied from 15V to 40V at 0 mA -30 mA with a maximum output power of 1W. The output voltage can be adjusted from 15V to 40V in 5V steps using a push button switch, S1, with 2% regulation. An MCP9700 Linear Active Thermistor™ device is provided on-board, which can be used to monitor the ambient temperature and accordingly regulate the output voltage depending on the thermal reading.

## 1.3 WHAT THE MCP1630 COUPLED INDUCTOR BOOST CONVERTER DEMO BOARD KIT INCLUDES

This MCP1630 Coupled Inductor Boost Converter Demo Board Kit includes:

- MCP1630 Coupled Inductor Boost Converter Demo Board (102-00091)
- MCP1630 Coupled Inductor Boost Converter Demo Board User's Guide (DS51612)



# MCP1630 COUPLED INDUCTOR BOOST CONVERTER DEMO BOARD USER'S GUIDE

---

---

## Chapter 2. Installation and Operation

---

---

### 2.1 INTRODUCTION

The MCP1630 Coupled Inductor Boost Converter Demo Board demonstrates Microchip's High-Speed Pulse Width Modulator (PWM) used in a coupled inductor design. When used in conjunction with a microcontroller, the MCP1630 device will control the power system duty cycle to provide different regulated output voltages using push button S1. The PIC12F683 microcontroller is used to generate oscillator pulses, reference voltage and output voltage selection using push button S1. The PIC12F683 can also be programmed to monitor the board ambient temperature using the MCP9700 Linear Active Thermistor™ device and provide different regulated output voltages for different thermal readings. The MCP1630 device generates duty cycle based on various external inputs. External signals include the input oscillator pulses, reference voltage from PIC12F683 device, and the feedback voltage. The output signal is a square-wave pulse given to drive the MOSFET.

The PIC12F683 microcontroller is programmable, allowing the user to modify or develop their own firmware routines to further evaluate the MCP1630 device in this application.

### 2.2 FEATURES

The MCP1630 Coupled Inductor Boost Converter Demo Board has the following features.

- With reduced stress on the MOSFET switch, provides greater degree of freedom in selecting the MOSFET
- Provides a varied output voltage selection from 15V to 40V in steps of 5V
- Push button select option for the required output voltage selection and ON/OFF control
- Tight line and load regulation and high efficiency over entire operating input voltage range
- PIC12F683 microcontroller is used to generate the Oscillator pulse and reference voltage at required duty cycle
- MCP9700 Linear Active Thermistor device for monitoring the temperature and output voltage control
- Proprietary features can be added by modifying the firmware contained in the PIC12F683 microcontroller
- The factory programmed source code is available

## 2.3 GETTING STARTED

The MCP1630 Coupled Inductor Boost Converter Demo Board is fully assembled and tested. The board requires the use of an external input voltage source (3.0V to 5.5V) and external load of Max 1W.

### 2.3.1 Power Input and Output Connection

#### 2.3.1.1 POWERING THE MCP1630 COUPLED INDUCTOR BOOST CONVERTER DEMO BOARD

1. Connect the positive side of the input source (+) to TP1. Connect the negative or return side (-) of input source to TP2. Refer to Figure 2-1. The input voltage source should be limited from 3.0V to 5.5V range. As the input voltage is applied and the system powers up, the firmware program of the PIC12F683 device will initialize and help the converter remain in low-power sleep mode ( $<0.1 \mu\text{A}$ ) until the S1 push button is pressed for  $> 2$  seconds by the user. If the S1 push button is pressed for less than 2 seconds, the converter will not power up.
2. Once the S1 push button is pressed for 2 seconds, the MCP1630 Coupled Inductor Boost Converter Demo Board is powered on delivering an output voltage of 40V with a maximum power of 1W. The S1 push button can also be used to provide a variable output voltage from 40V to 15V in 5V steps. Each depression of the S1 push button for  $<2$  seconds (short key press) after the converter is enabled will provide a decrementing output voltage from 40V to 15V range in reducing 5V steps in cyclic order.
3. At any of the output voltages, if the S1 push button is pressed for more than 2 seconds, the MCP1630 Coupled Inductor Boost Converter Demo Board goes into low power sleep mode, turning the converter off.
4. Again, a subsequent depressing of the S1 push button for more than 2 seconds wakes the converter from sleep mode and the output is powered at 40V.

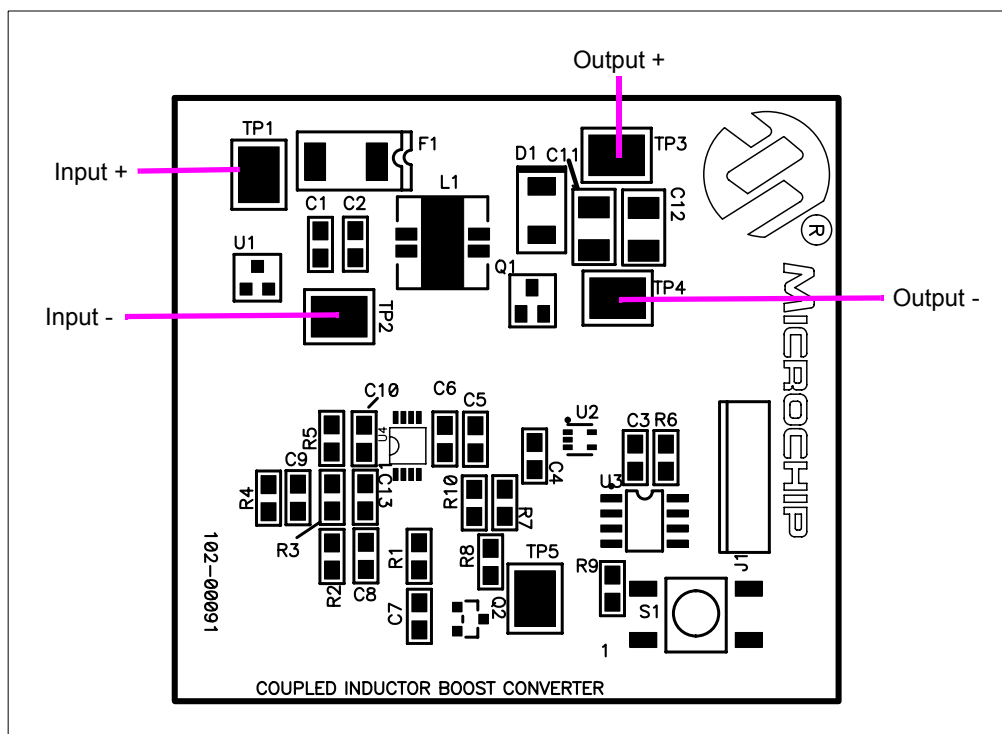

FIGURE 2-1: Setup Configuration Diagram.

## 2.3.1.2 APPLYING LOAD TO MCP1630 COUPLED INDUCTOR BOOST CONVERTER DEMO BOARD

A variable resistive load can be used to verify the line and load regulation. The load resistance is connected between the TP3 and TP4 test points. To measure the output voltage, connect the common lead of the multi meter to TP4 and the positive terminal to TP3. By varying the load, the load regulation can be verified by measuring the output voltage over the entire load range of 0 mA to 30 mA. Similarly, by varying the line voltage from 3V to 5.5V and checking the output voltage, the line regulation can be calculated.

### Evaluating the Application

The best way to evaluate the MCP1630 Coupled Inductor Boost Converter Demo Board is to dig into the circuit. Measure voltages and currents with a Digital Volt Meter (DVM) and probe the board with an oscilloscope.

The voltage on the switching node can be calculated below.

$$V_{SW} = V_{IN} + \left[ (V_{OUT} + V_D - V_{IN}) \frac{N_2}{N_1 + N_2} \right]$$

Where:

- $V_{SW}$  = Voltage across switch
- $V_{OUT}$  = Output Voltage
- $V_D$  = Diode Drop
- $V_{IN}$  = Input Voltage
- $N_1$  &  $N_2$  = Coupled Inductor Turns Ratio  
( $N_1$  and  $N_2$  is 1 for a 1:1 ratio coupled inductor)

### Firmware

The PIC12F683 device comes preprogrammed with firmware to operate the system as described above. The firmware flow diagram is shown in **Appendix C. "Demo Board Firmware"**.

The program is fairly simple and straight forward. There is an initialization routine at the beginning of the program.

The internal oscillator clock is set to 8 MHz. The TRISIO is configured to set GP2 (Oscillator pulses to the MCP1630) and GP5 ( $V_{REF}$  Voltage to MCP1630) as an output port and GP3 (Push button S1) as Input Port. The OPTION register is configured to wake-up on Port pin change of GP3.

The TMR0 is initialized with a value which causes TMR0 to overflow after 10 ms. The TMR0 overflow interrupt is also enabled. Initialize registers TEMP and TEMP2 for 2 seconds time measurement.

TMR0 overflow occurs for every 10 ms.  
TEMP and TEMP2 counts for 2 seconds (TEMP2 = 10, TEMP = 20)  
Hence  $10 * 20 * 10 \text{ ms} = 2 \text{ Seconds}$ )

The PWM duty cycle is specified by writing to the CCPR1L register and to the CCP1CON <5:4> bits. The CCPR1L contains the eight MSBs and the CCP1CON <5:4> contains the two LSbs. This 10-bit value is represented by CCPR1L:CCP1CON <5:4>. The switching frequency is set to 100 kHz.

Upon powering on, the processor enters into SLEEP mode after the ports are initialized and registers configured. The processor wakes-up from SLEEP mode if the push button S1 on GP3 is pressed. TEMP and TEMP2 registers check whether the push button S1 is pressed for more than 2 seconds. If the push button S1 is pressed for less than 2 seconds, will not allow the TEMP1 register to set, which indicates that the push button is not pressed for more than 2 seconds and the processor goes back to SLEEP mode.

Once the processor is on after the push button is pressed for 2 seconds, the output voltage is set at 40V by generating  $V_{REF}$  Voltage. TMR1 is configured for generating  $V_{REF}$  Voltage. The duty cycle and period values are loaded to generate different  $V_{REF}$  Voltages.

Period is fixed for 508  $\mu$ s  $\approx$  1.94 kHz.

Off Time (Duty cycle) is varied from 308  $\mu$ s to 508  $\mu$ s.

Off time @ Duty Cycle	=	00 is 00 $\mu$ s (For 40V Output)
	=	10 is 64 $\mu$ s (For 35V Output)
	=	20 is 128 $\mu$ s (For 30V Output)
	=	30 is 192 $\mu$ s (For 25V Output)
	=	40 is 256 $\mu$ s (For 20V Output)
	=	50 is 320 $\mu$ s (For 15V Output)

Each short depression of push button S1 will load different duty cycles to generate different  $V_{REF}$  voltages which decrements the output voltage from 40V to 15V in reducing steps of 5V in cyclic order. A key debounce delay of 300 ms is introduced between each short push button depressions.

At any of the output voltages, if the push button S1 is pressed for more than 2 seconds, the processor goes into SLEEP mode by clearing the TEMP1 register.

Again, a subsequent depression of push button S1 for more than 2 seconds wakes the processor from SLEEP mode by setting the TEMP1 register and output is powered at 40V.

The firmware program in the PIC12F683 device can be edited to modify the operation of the application.

An additional feature can be incorporated in the firmware program where one can vary the output voltage depending on the board ambient temperature. The MCP9700 Linear Active Thermistor provided on-board can be directly interfaced to a MCU, and the firmware suitably modified to achieve the objective. This feature is presently not implemented in this demo board.

## Programming

Header J1 is provided for in-circuit programming. This is an optional feature, since the MCP1630 Coupled Inductor Boost Converter Demo Board comes preprogrammed with firmware to operate the system. The PIC12F683 device can be reprogrammed with the Baseline Flash Microcontroller Programmer (BFMP).



# MCP1630 COUPLED INDUCTOR BOOST CONVERTER DEMO BOARD USER'S GUIDE

---

---

## Appendix A. Schematic and Layouts

---

---

### A.1 INTRODUCTION

This appendix contains the following schematics and layouts for the MCP1630 Coupled Inductor Boost Converter Demo Board:

- Board – Schematic
- Board – Top Silk Layer
- Board – Top Metal Layer
- Board – Bottom Metal Layer

## A.2 BOARD – SCHEMATIC

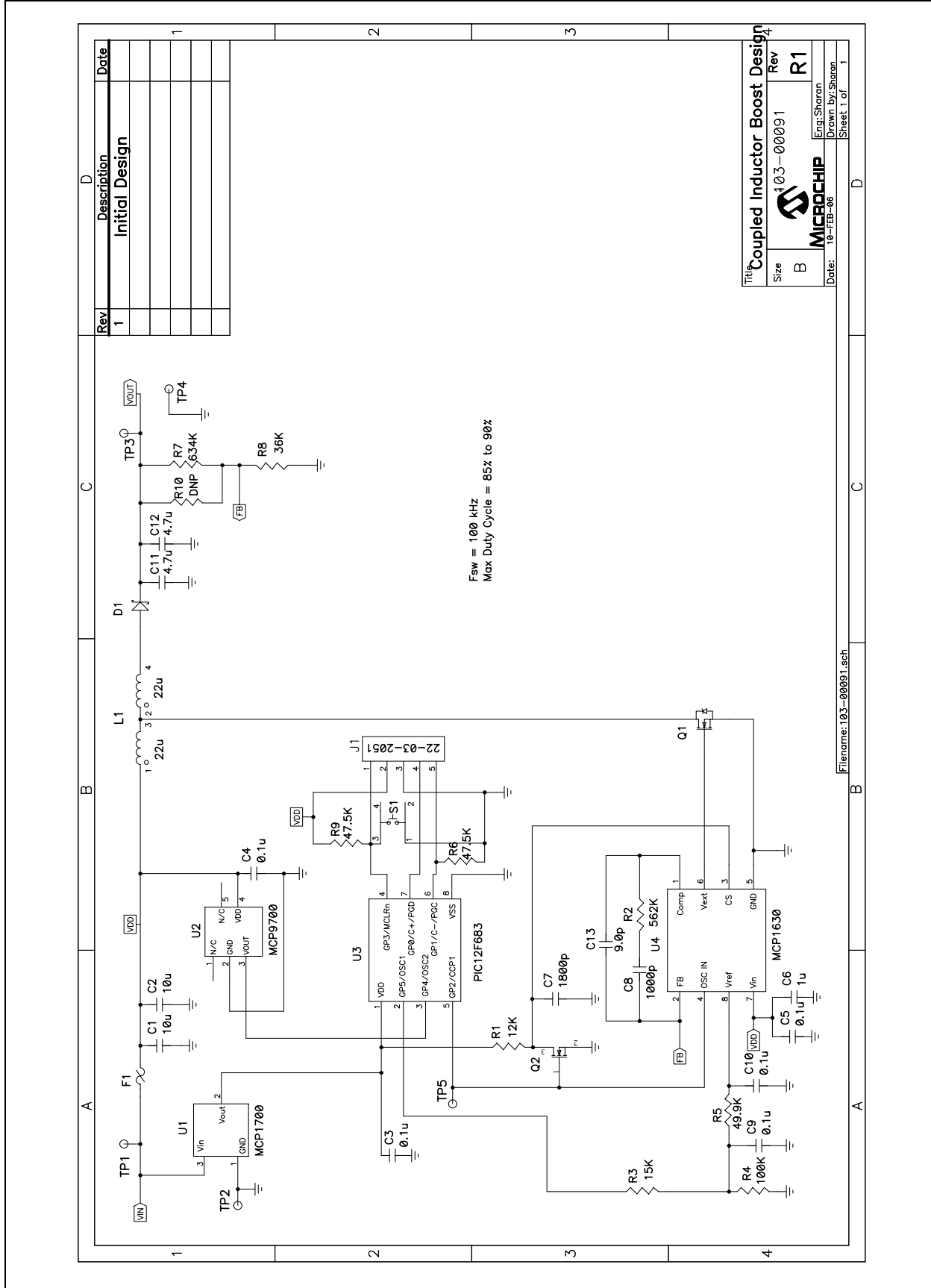



## A.3 BOARD – TOP SILK LAYER

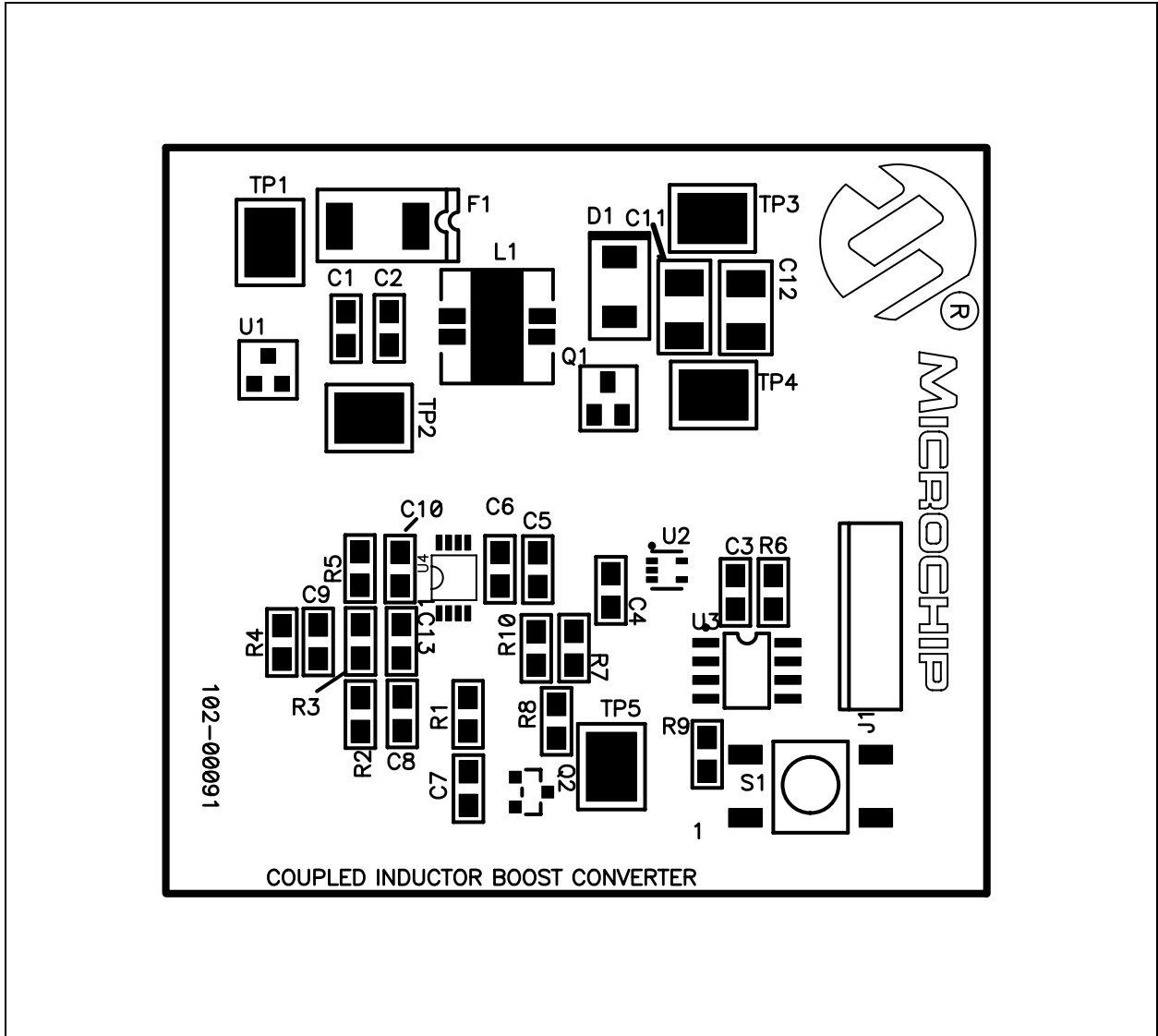

**A.4 BOARD – TOP METAL LAYER**

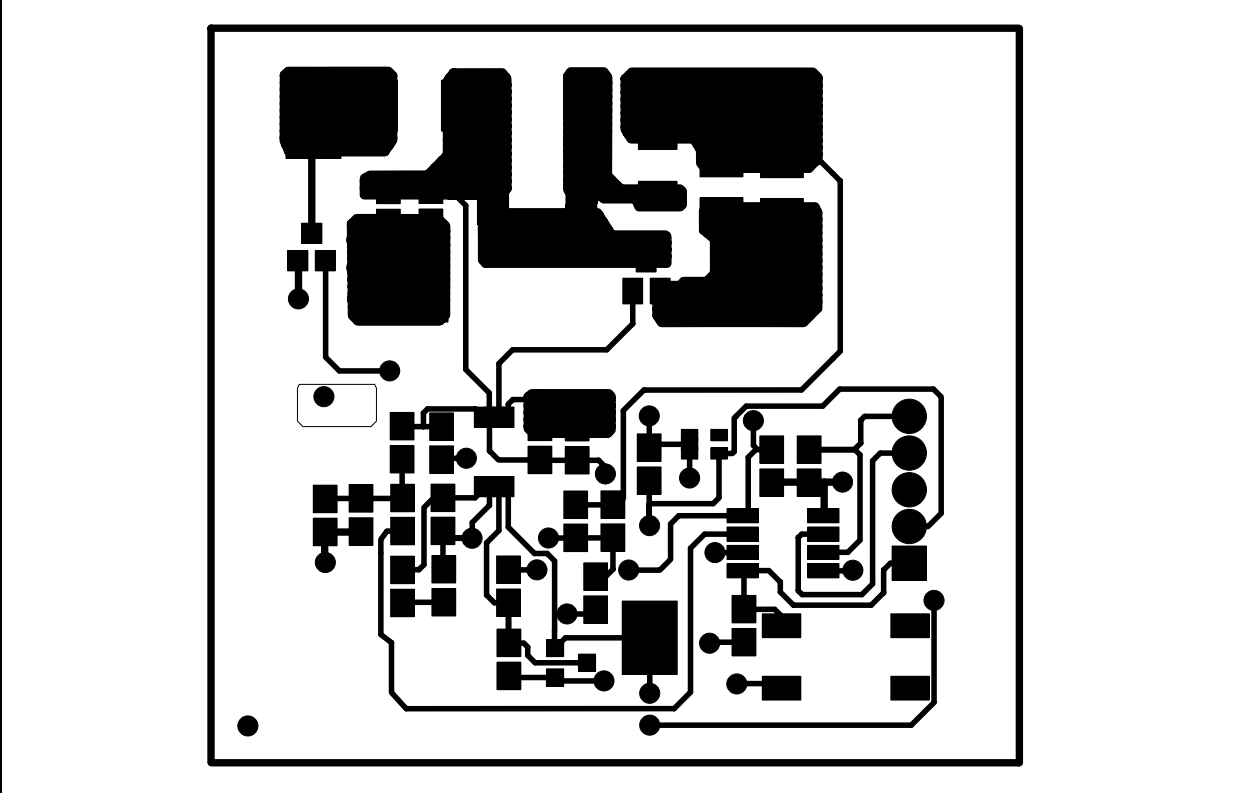

## A.5 BOARD – BOTTOM METAL LAYER

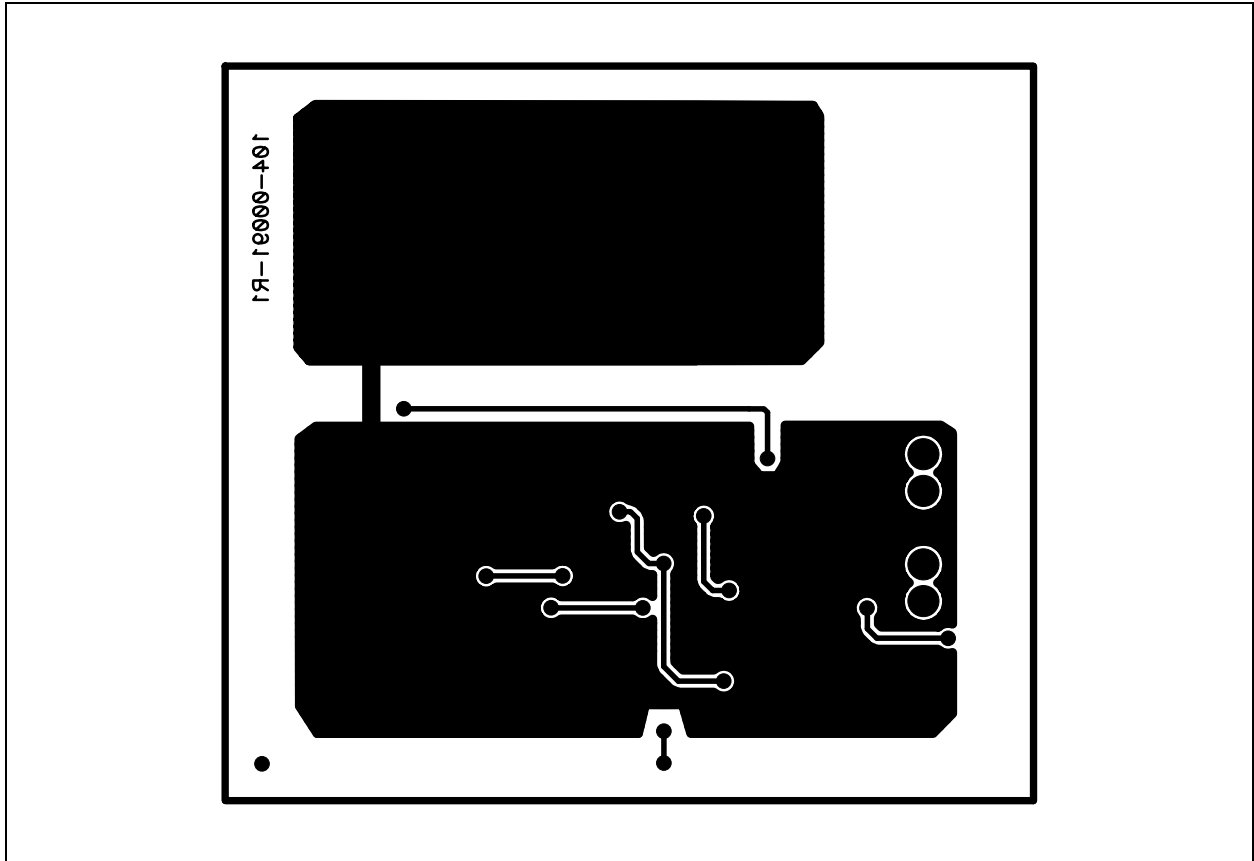

# **MCP1630 Coupled Inductor Boost Converter Demo Board User's Guide**

---

---

NOTES:



# MCP1630 COUPLED INDUCTOR BOOST MICROCHIP CONVERTER DEMO BOARD USER'S GUIDE

## Appendix B. Bill Of Materials (BOM)

**TABLE B-1: BILL OF MATERIALS (BOM)**

Qty	Reference	Description	Manufacture	Part Number
2	C1, C2	Cap 10uF 6.3V Ceramic X5R 0805	Panasonic® - ECG	ECJ-2FB0J106M
5	C3, C4, C5, C9, C10	Cap 0.1uF 16V Ceramic X7R 0805	Panasonic - ECG	ECJ-2VB1C104K
1	C6	Cap 1uF 16V Ceramic 0805 X5R	Panasonic - ECG	ECJ-2FB1C105K
1	C7	Cap Ceramic1800pF 50V NPO 0805	Panasonic - ECG	ECJ-2VC1H182J
1	C8	Cap 1000pF 50V Cerm Chip 0805	Panasonic - ECG	ECJ-2VC1H102J
2	C11, C12	Cap 4.7uF 50V Ceramic F 1210	Panasonic - ECG	ECJ-4YF1H475Z
1	C13	Cap 9.0pF 50V Cerm Chip 0805 SMD	Panasonic - ECG	ECJ-2VC1H090D
1	D1	Diode Schottky 60V 1A SMB	International Rectifier	10BQ060PBF
1	J1	Conn Header 5 Pos.100 Vert Tin	Molex® Electronics	22-03-2051
1	F1	Polyswitch Resettable Fuses	Keystone Electronics	MINISMDC110F-2
1	L1	Inductor shield dual 22uH SMD	Coiltronics/ Div of Cooper/Bussmann	DRQ74-220-R
1	Q1	MOSFET N-CH 30V 2.2A SSOT3	Fairchild Semiconductor®	FDN337N
1	Q2	MOSFET N-CH 60V 280mA SOT-23	Fairchild Semiconductor	NDS7002A
1	R1	Res 12.0K Ohm 1/8W 5% 0805 SMD	Panasonic - ECG	ERJ-6GEYJ123V
1	R2	Res 562K Ohm 1/8W 1% 0805 SMD	Panasonic - ECG	ERJ-6ENF5623V
1	R3	Res 15.0K Ohm 1/8W 1% 0805 SMD	Panasonic - ECG	ERJ-6ENF1502V
1	R4	Res 100K Ohm 1/8W 1% 0805 SMD	Panasonic - ECG	ERJ-6ENF1003V
1	R5	Res 49.9K Ohm 1/8W 1% 0805 SMD	Panasonic - ECG	ERJ-6ENF4992V
2	R6,R9	Res 47.5K Ohm 1/8W 1% 0805 SMD	Panasonic - ECG	ERJ-6ENF4752V
1	R7	Res 634K Ohm 1/8W 1% 0805 SMD	Panasonic - ECG	ERJ-6ENF6343V
1	R8	Res 36.0K Ohm 1/8W 5% 0805 SMD	Panasonic - ECG	ERJ-6GEYJ363V
0	R10	Not Used	—	—
1	S1	Momentary Tact Switches	E-Switch Inc.	TL3301NF260QG
5	TP1,TP2,TP3, TP4,TP5	PC Test point compact SMT	Keystone Electronics®	5016
1	U1	IC LDO REG 250mA 2.5V SOT-23	Microchip Technology Inc.	MCP1700T-2502E/TT
1	U2	IC Sensor Thermal 2.3V SC70-5	Microchip Technology Inc.	MCP9700T-E/LT
1	U3	IC MCU Flash 2KX14 8SOIC	Microchip Technology Inc.	PIC12F683-I/SN
1	U4	IC PWM HS MCU-Adaptable 8MSOP	Microchip Technology Inc.	MCP1630-E/MS

**Note 1:** The components listed in this Bill of Materials are representative of the PCB assembly. The released BOM used in manufacturing uses all RoHS-compliant components.

# **MCP1630 Coupled Inductor Boost Converter Demo Board User's Guide**

---

---

NOTES:



# MCP1630 COUPLED INDUCTOR BOOST CONVERTER DEMO BOARD USER'S GUIDE

## Appendix C. Demo Board Firmware

### C.1 DEVICE FIRMWARE

For the latest version of the MCP1630 Coupled Inductor Boost Converter Demo Board firmware, visit the Microchip web site at [www.microchip.com](http://www.microchip.com).

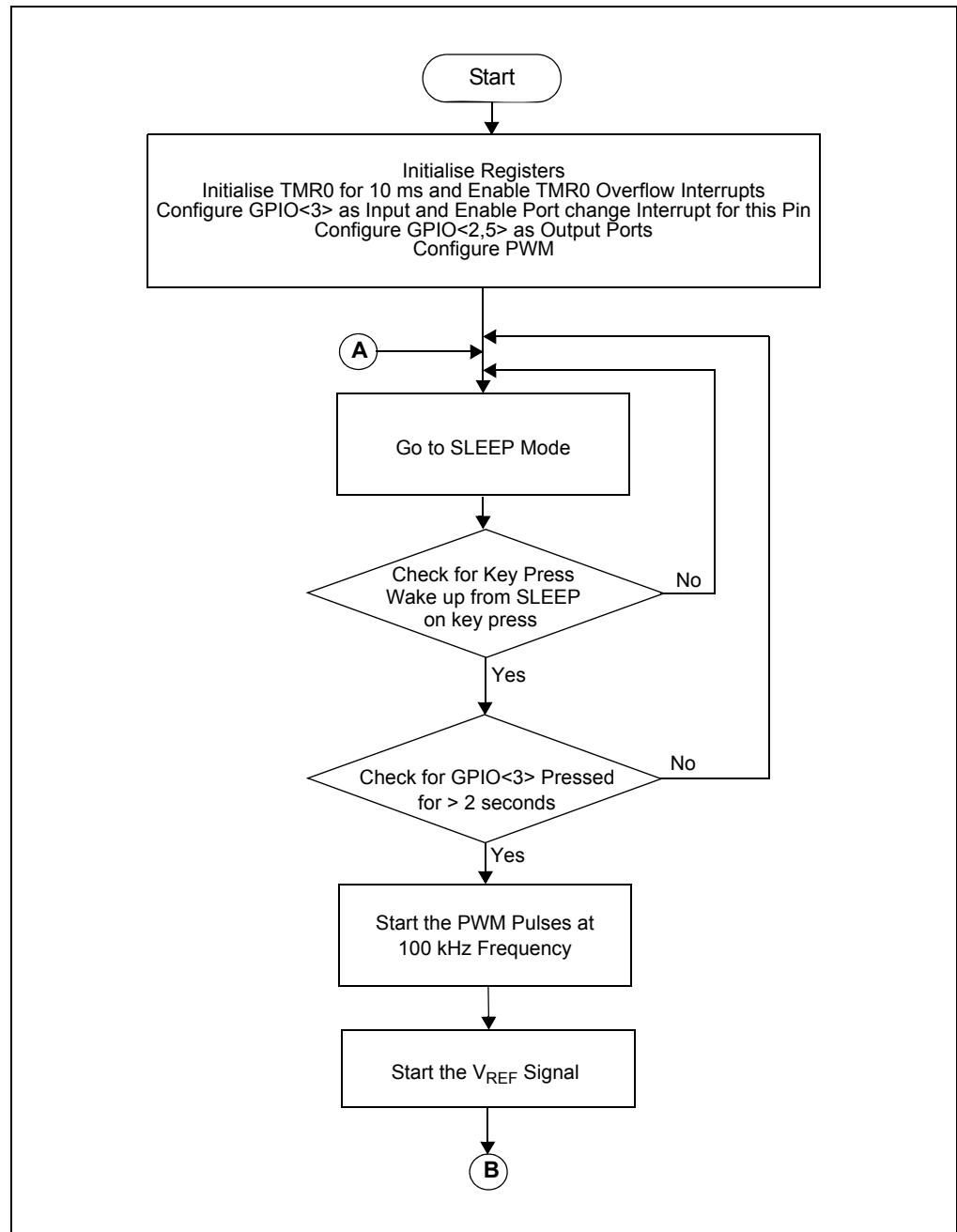

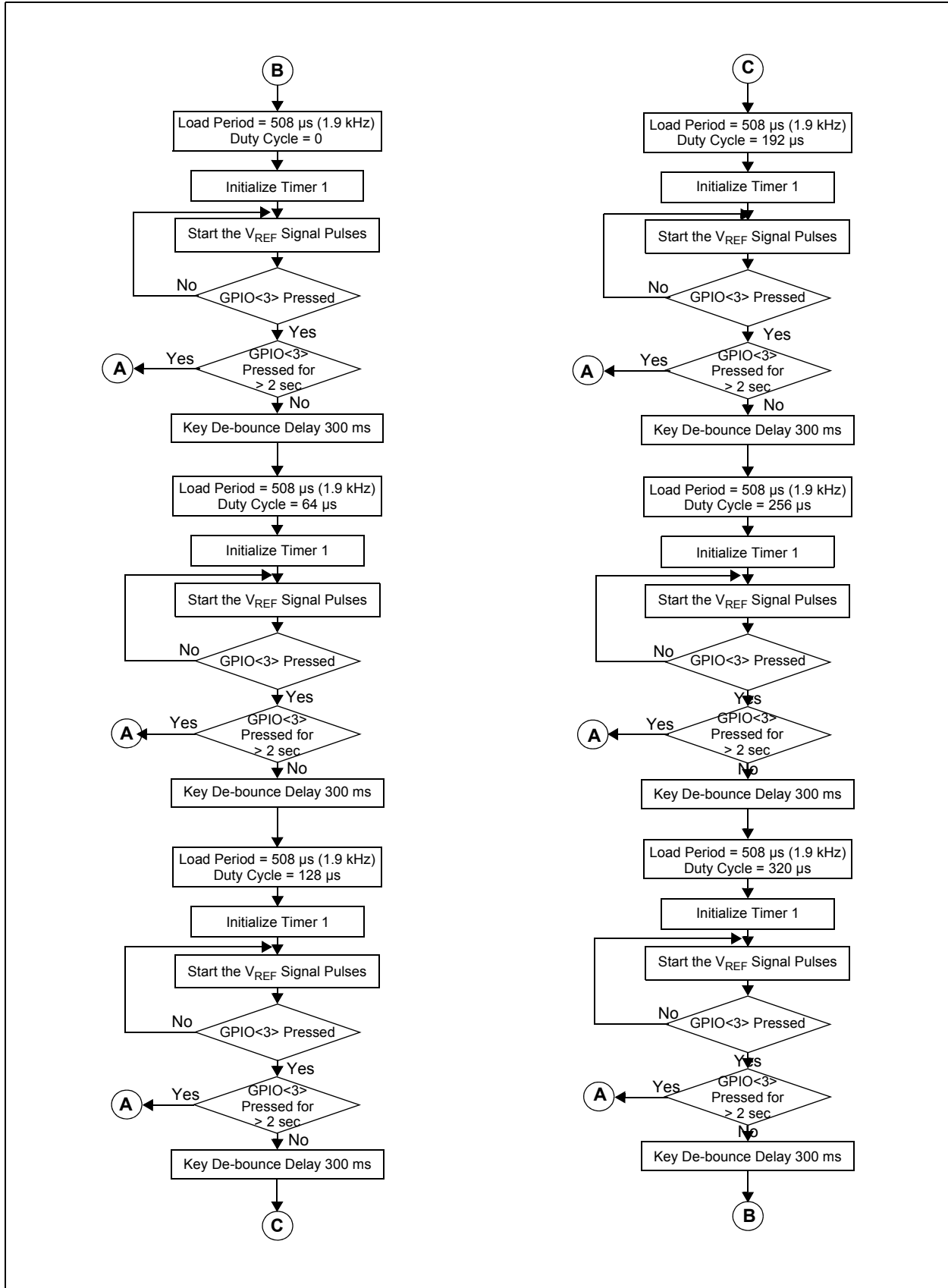

**FIGURE C-1:** Firmware Flowchart.



NOTES:



**MICROCHIP**

---

---

## WORLDWIDE SALES AND SERVICE

---

---

### AMERICAS

**Corporate Office**  
2355 West Chandler Blvd.  
Chandler, AZ 85224-6199  
Tel: 480-792-7200  
Fax: 480-792-7277  
Technical Support:  
<http://support.microchip.com>  
Web Address:  
[www.microchip.com](http://www.microchip.com)

**Asia Pacific Office**  
Suites 3707-14, 37th Floor  
Tower 6, The Gateway  
Harbour City, Kowloon  
Hong Kong  
Tel: 852-2401-1200  
Fax: 852-2401-3431

**Atlanta**  
Alpharetta, GA  
Tel: 770-640-0034  
Fax: 770-640-0307

**Boston**  
Westborough, MA  
Tel: 774-760-0087  
Fax: 774-760-0088

**Chicago**  
Itasca, IL  
Tel: 630-285-0071  
Fax: 630-285-0075

**Dallas**  
Addison, TX  
Tel: 972-818-7423  
Fax: 972-818-2924

**Detroit**  
Farmington Hills, MI  
Tel: 248-538-2250  
Fax: 248-538-2260

**Kokomo**  
Kokomo, IN  
Tel: 765-864-8360  
Fax: 765-864-8387

**Los Angeles**  
Mission Viejo, CA  
Tel: 949-462-9523  
Fax: 949-462-9608

**San Jose**  
Mountain View, CA  
Tel: 650-215-1444  
Fax: 650-961-0286

**Toronto**  
Mississauga, Ontario,  
Canada  
Tel: 905-673-0699  
Fax: 905-673-6509

### ASIA/PACIFIC

**Australia - Sydney**  
Tel: 61-2-9868-6733  
Fax: 61-2-9868-6755

**China - Beijing**  
Tel: 86-10-8528-2100  
Fax: 86-10-8528-2104

**China - Chengdu**  
Tel: 86-28-8676-6200  
Fax: 86-28-8676-6599

**China - Fuzhou**  
Tel: 86-591-8750-3506  
Fax: 86-591-8750-3521

**China - Hong Kong SAR**  
Tel: 852-2401-1200  
Fax: 852-2401-3431

**China - Qingdao**  
Tel: 86-532-8502-7355  
Fax: 86-532-8502-7205

**China - Shanghai**  
Tel: 86-21-5407-5533  
Fax: 86-21-5407-5066

**China - Shenyang**  
Tel: 86-24-2334-2829  
Fax: 86-24-2334-2393

**China - Shenzhen**  
Tel: 86-755-8203-2660  
Fax: 86-755-8203-1760

**China - Shunde**  
Tel: 86-757-2839-5507  
Fax: 86-757-2839-5571

**China - Wuhan**  
Tel: 86-27-5980-5300  
Fax: 86-27-5980-5118

**China - Xian**  
Tel: 86-29-8833-7250  
Fax: 86-29-8833-7256

### ASIA/PACIFIC

**India - Bangalore**  
Tel: 91-80-4182-8400  
Fax: 91-80-4182-8422

**India - New Delhi**  
Tel: 91-11-5160-8631  
Fax: 91-11-5160-8632

**India - Pune**  
Tel: 91-20-2566-1512  
Fax: 91-20-2566-1513

**Japan - Yokohama**  
Tel: 81-45-471-6166  
Fax: 81-45-471-6122

**Korea - Gumi**  
Tel: 82-54-473-4301  
Fax: 82-54-473-4302

**Korea - Seoul**  
Tel: 82-2-554-7200  
Fax: 82-2-558-5932 or  
82-2-558-5934

**Malaysia - Penang**  
Tel: 60-4-646-8870  
Fax: 60-4-646-5086

**Philippines - Manila**  
Tel: 63-2-634-9065  
Fax: 63-2-634-9069

**Singapore**  
Tel: 65-6334-8870  
Fax: 65-6334-8850

**Taiwan - Hsin Chu**  
Tel: 886-3-572-9526  
Fax: 886-3-572-6459

**Taiwan - Kaohsiung**  
Tel: 886-7-536-4818  
Fax: 886-7-536-4803

**Taiwan - Taipei**  
Tel: 886-2-2500-6610  
Fax: 886-2-2508-0102

**Thailand - Bangkok**  
Tel: 66-2-694-1351  
Fax: 66-2-694-1350

### EUROPE

**Austria - Wels**  
Tel: 43-7242-2244-3910  
Fax: 43-7242-2244-393

**Denmark - Copenhagen**  
Tel: 45-4450-2828  
Fax: 45-4485-2829

**France - Paris**  
Tel: 33-1-69-53-63-20  
Fax: 33-1-69-30-90-79

**Germany - Munich**  
Tel: 49-89-627-144-0  
Fax: 49-89-627-144-44

**Italy - Milan**  
Tel: 39-0331-742611  
Fax: 39-0331-466781

**Netherlands - Drunen**  
Tel: 31-416-690399  
Fax: 31-416-690340

**Spain - Madrid**  
Tel: 34-91-708-08-90  
Fax: 34-91-708-08-91

**UK - Wokingham**  
Tel: 44-118-921-5869  
Fax: 44-118-921-5820

06/08/06

Компания «Океан Электроники» предлагает заключение долгосрочных отношений при поставках импортных электронных компонентов на взаимовыгодных условиях!

Наши преимущества:

- Поставка оригинальных импортных электронных компонентов напрямую с производств Америки, Европы и Азии, а так же с крупнейших складов мира;
- Широкая линейка поставок активных и пассивных импортных электронных компонентов (более 30 млн. наименований);
- Поставка сложных, дефицитных, либо снятых с производства позиций;
- Оперативные сроки поставки под заказ (от 5 рабочих дней);
- Экспресс доставка в любую точку России;
- Помощь Конструкторского Отдела и консультации квалифицированных инженеров;
- Техническая поддержка проекта, помощь в подборе аналогов, поставка прототипов;
- Поставка электронных компонентов под контролем ВП;
- Система менеджмента качества сертифицирована по Международному стандарту ISO 9001;
- При необходимости вся продукция военного и аэрокосмического назначения проходит испытания и сертификацию в лаборатории (по согласованию с заказчиком);
- Поставка специализированных компонентов военного и аэрокосмического уровня качества (Xilinx, Altera, Analog Devices, Intersil, Interpoint, Microsemi, Actel, Aeroflex, Peregrine, VPT, Syfer, Eurofarad, Texas Instruments, MS Kennedy, Miteq, Cobham, E2V, MA-COM, Hittite, Mini-Circuits, General Dynamics и др.);

Компания «Океан Электроники» является официальным дистрибьютором и эксклюзивным представителем в России одного из крупнейших производителей разъемов военного и аэрокосмического назначения «JONHON», а так же официальным дистрибьютором и эксклюзивным представителем в России производителя высокотехнологичных и надежных решений для передачи СВЧ сигналов «FORSTAR».



## JONHON

«JONHON» (основан в 1970 г.)

Разъемы специального, военного и аэрокосмического назначения:

(Применяются в военной, авиационной, аэрокосмической, морской, железнодорожной, горно- и нефтедобывающей отраслях промышленности)

«FORSTAR» (основан в 1998 г.)

ВЧ соединители, коаксиальные кабели,  
кабельные сборки и микроволновые компоненты:

(Применяются в телекоммуникациях гражданского и специального назначения, в средствах связи, РЛС, а так же военной, авиационной и аэрокосмической отраслях промышленности).



Телефон: 8 (812) 309-75-97 (многоканальный)

Факс: 8 (812) 320-03-32

Электронная почта: [ocean@oceanchips.ru](mailto:ocean@oceanchips.ru)

Web: <http://oceanchips.ru/>

Адрес: 198099, г. Санкт-Петербург, ул. Калинина, д. 2, корп. 4, лит. А