**VOLTAGE DETECTOR
WITH OUTPUT DELAY
RN5VD SERIES**

APPLICATION MANUAL

RN5VD SERIES

OUTLINE

The RN5VD Series are voltage detector ICs with output delay functions and high detector threshold accuracy and ultra-low supply current by CMOS process, which can be operated at an extremely low voltage and is used, for instance, for system reset.

Each of these ICs consists of a voltage reference unit, a comparator, resistors for voltage detection, an output driver, a hysteresis circuit and an output delay generator. The detector threshold is fixed with high accuracy in the IC and requires no adjustment.

The RN5VD Series are operable by a lower voltage than that for the R×5VL Series, and can be driven by a single battery.

Two output types, Nch open drain type and CMOS type, are available. Since the package for these ICs are SOT-23-5(Mini-mold)package, high density mounting of the ICs on board is possible.

FEATURES

- Output DelayTYP. 100ms with external capacitor : 0.15μF
- Ultra-low supply currentTYP. 1.0μA (RN5VD15× : V_{DD}=3.5V)
- Broad Operating Voltage Range0.7V to 10.0V
- Detector ThresholdStepwise setting with a step of 0.1V in the range of 0.9V to 6.0V is possible. (refer to Selection Guide) .
- High accuracy detector threshold±2.5%
- Low Temperature-Drift Coefficient of Detector ThresholdTYP. ±100ppm/°C
- Two Output TypesNch Open Drain and CMOS
- Small PackageSOT-23-5(Mini-mold)

APPLICATIONS

- CPU & Logic Circuit Reset
- Battery Checker
- Window Comparator
- Wave Shaping Circuit
- Battery Back-Up Circuit
- Power Failure Detector

BLOCK DIAGRAMS

• Nch Open Drain Output (RN5VD××A)

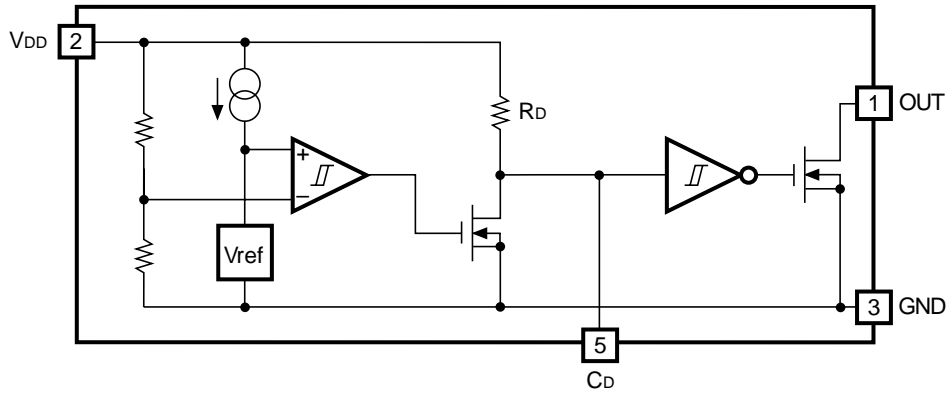

• CMOS Output (RN5VD××C)

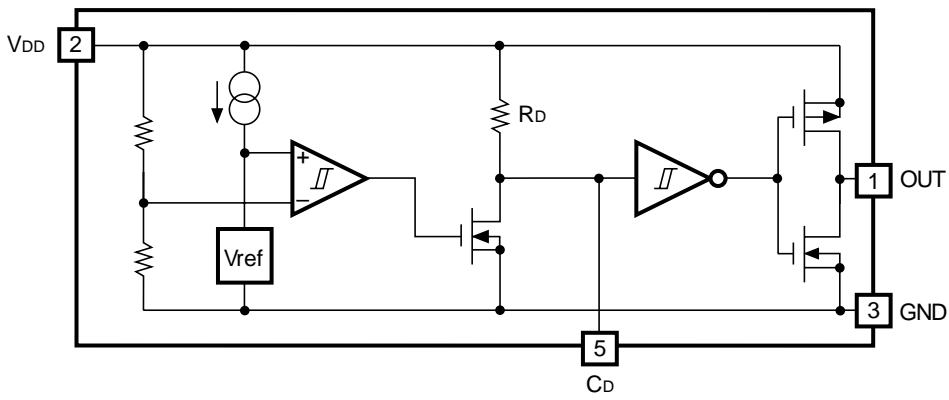

SELECTION GUIDE

The detector threshold, the output type, the packing type, and the taping type of RN5VD Series can be designating at the user's request by specifying the part number as follows :

RN5VDXXXX-XX ← Part Number
 ↑ ↑ ↑ ↑
 a b c d

Code	Contents
a	Setting Detector Threshold ($-V_{DET}$) : Stepwise setting with a step of 0.1V in the range of 0.9V to 6.0V is possible.
b	Designation of Output Type A: Nch Open Drain C: CMOS
c	Designation of Packing Type A: Taping C: Antistatic bag for samples
d	Designation of Taping Type: Ex. SOT-23-5: TR, TL (refer to Taping Specification) "TR" is prescribed as a standard.

For example, the Product with Detector Threshold 3.5V, Output Type Nch Open Drain and Taping Type TR, is designated by Part Number RN5VD35AA-TR.

PIN CONFIGURATION

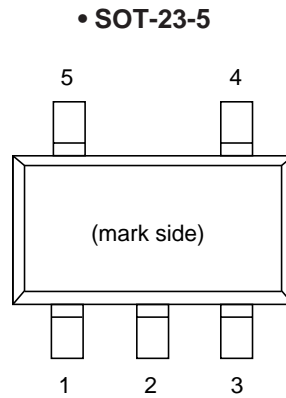

PIN DESCRIPTION

Pin No.	Symbol	Description
1	OUT	Output Pin
2	V _{DD}	Input and power source for device itself
3	GND	Ground Pin
4	NC	No Connection
5	CD	Pin for external capacitor (for setting output delay)

ABSOLUTE MAXIMUM RATINGS

Symbol	Item	Rating		Unit
V _{DD}	Supply Voltage	12		V
V _{OUT}	Output Voltage	CNOS	V _{SS} -0.3 to V _{DD} +0.3	V
		Nch	V _{SS} -0.3 to 12	
I _{OUT}	Output Current	70		mA
P _D	Power Dissipation	150		mW
T _{opt}	Operating Temperature Range	-40 to +85		°C
T _{stg}	Storage Temperature Range	-55 to +125		°C
T _{solder}	Lead Temperature (Soldering)	260°C, 10s		

ABSOLUTE MAXIMUM RATINGS

Absolute Maximum ratings are threshold limit values that must not be exceeded even for an instant under any conditions. Moreover, such values for any two items must not be reached simultaneously. Operation above these absolute maximum ratings may cause degradation or permanent damage to the device. These are stress ratings only and do not necessarily imply functional operation below these limits.

ELECTRICAL CHARACTERISTICS

• RN5VD09A/C

T_{opt}=25°C

Symbol	Item	Conditions	MIN.	TYP.	MAX.	Unit.
-V _{DET}	Detector Threshold		0.878	0.900	0.922	V
V _{HYS}	Detector Threshold Hysteresis		0.027	0.045	0.063	V
I _{SS}	Supply Current	V _{DD} =0.8V		1.5	3.7	μA
		V _{DD} =2.9V		0.9	2.7	
V _{DDH}	Maximum Operating Voltage				10	V
V _{DDL}	Minimum Operating Voltage (Note 1)	T _{opt} =25°C		0.55	0.70	V
		-30°C≤T _{opt} ≤85°C		0.65	0.80	
I _{OUT}	Output Current	Nch	V _{DS} =0.05V, V _{DD} =0.7V	0.01	0.05	mA
			V _{DS} =0.5V, V _{DD} =0.85V	0.05	0.50	
		Pch	V _{DS} =-2.1V, V _{DD} =4.5V	1.0	2.0	mA
V _{TCD}	CD pin Threshold Voltage	V _{DD} =0.99V	0.297	0.495	0.693	V
I _{CD}	CD pin Sink Current	V _{DS} =0.1V, V _{DD} =0.7V	2.0	30	μA	
		V _{DS} =0.5V, V _{DD} =0.85V	10.0	100.0		
R _D	Delay Resistance		0.5	1.0	2.0	MΩ
$\frac{\Delta-V_{DET}}{\Delta T_{opt}}$	Detector Threshold Temperature Coefficient	-30°C≤T _{opt} ≤85°C		±100		ppm/°C

(Note 1) Minimum Operating Voltage means the value of input voltage when output voltage maintains 0.1V or less, provided that in the case of Nch Open Drain Type Products, the pull-up resistance is set at 470kΩ, and the pull-up voltage is set at 5.0V.

• RN5VD18A/C

T_{opt}=25°C

Symbol	Item	Conditions	MIN.	TYP.	MAX.	Unit.
-V _{DET}	Detector Threshold		1.755	1.800	1.845	V
V _{HYS}	Detector Threshold Hysteresis		0.054	0.090	0.126	V
I _{SS}	Supply Current	V _{DD} =1.7V		2.5	5.0	μA
		V _{DD} =3.8V		1.0	3.0	
V _{DDH}	Maximum Operating Voltage				10	V
V _{DDL}	Minimum Operating Voltage (Note 1)	T _{opt} =25°C -30°C≤T _{opt} ≤85°C		0.55 0.65	0.70 0.80	V
I _{OUT}	Output Current	Nch	V _{DS} =0.05V, V _{DD} =0.7V	0.01	0.05	mA
			V _{DS} =0.5V, V _{DD} =1.5V	1.0	2.0	
		Pch	V _{DS} =-2.1V, V _{DD} =4.5V	1.0	2.0	mA
V _{TCD}	CD pin Threshold Voltage	V _{DD} =1.98V	0.693	0.990	1.287	V
I _{CD}	CD pin Sink Current	V _{DS} =0.1V, V _{DD} =0.7V	2.0	30	μA	
		V _{DS} =0.5V, V _{DD} =1.5V	200.0	800.0		
R _D	Delay Resistance		0.5	1.0	2.0	MΩ
$\frac{\Delta-V_{DET}}{\Delta T_{opt}}$	Detector Threshold Temperature Coefficient	-30°C≤T _{opt} ≤85°C		±100		ppm/°C

(Note 1) Minimum Operating Voltage means the value of input voltage when output voltage maintains 0.1V or less, provided that in the case of Nch Open Drain Type Products, the pull-up resistance is set at 470kΩ, and the pull-up voltage is set at 5.0V.

RN5VD

• RN5VD27A/C

T_{opt}=25°C

Symbol	Item	Conditions	MIN.	TYP.	MAX.	Unit.
-V _{DET}	Detector Threshold		2.633	2.700	2.767	V
V _{HYS}	Detector Threshold Hysteresis		0.081	0.135	0.189	V
I _{SS}	Supply Current	V _{DD} =2.6V		3.5	7.0	μA
		V _{DD} =4.7V		1.1	3.3	
V _{DDH}	Maximum Operating Voltage				10	V
V _{DDL}	Minimum Operating Voltage (Note 1)	T _{opt} =25°C -30°C ≤ T _{opt} ≤ 85°C		0.55 0.65	0.70 0.80	V
I _{OUT}	Output Current	Nch	V _{DS} =0.05V, V _{DD} =0.7V	0.01	0.05	mA
			V _{DS} =0.5V, V _{DD} =1.5V	1.0	2.0	
		Pch	V _{DS} =-2.1V, V _{DD} =4.5V	1.0	2.0	mA
V _{TCD}	CD pin Threshold Voltage	V _{DD} =2.97V	1.188	1.485	1.782	V
I _{CD}	CD pin Sink Current	V _{DS} =0.1V, V _{DD} =0.7V	2.0	30	μA	
		V _{DS} =0.5V, V _{DD} =1.5V	200.0	800.0		
R _D	Delay Resistance		0.5	1.0	2.0	MΩ
$\frac{\Delta-V_{DET}}{\Delta T_{opt}}$	Detector Threshold Temperature Coefficient	-30°C ≤ T _{opt} ≤ 85°C		±100		ppm/°C

(Note 1) Minimum Operating Voltage means the value of input voltage when output voltage maintains 0.1V or less, provided that in the case of Nch Open Drain Type Products, the pull-up resistance is set at 470kΩ, and the pull-up voltage is set at 5.0V.

• RN5VD36A/C

T_{opt}=25°C

Symbol	Item	Conditions	MIN.	TYP.	MAX.	Unit.
-V _{DET}	Detector Threshold		3.510	3.600	3.690	V
V _{HYS}	Detector Threshold Hysteresis		0.108	0.180	0.252	V
I _{SS}	Supply Current	V _{DD} =3.47V		4.5	9.0	μA
		V _{DD} =5.6V		1.2	3.6	
V _{DDH}	Maximum Operating Voltage				10	V
V _{DDL}	Minimum Operating Voltage (Note 1)	T _{opt} =25°C -30°C ≤ T _{opt} ≤ 85°C		0.55 0.65	0.70 0.80	V
I _{OUT}	Output Current	Nch	V _{DS} =0.05V, V _{DD} =0.7V	0.01	0.05	mA
			V _{DS} =0.5V, V _{DD} =1.5V	1.0	2.0	
		Pch	V _{DS} =-2.1V, V _{DD} =4.5V	1.0	2.0	mA
V _{TCD}	CD pin Threshold Voltage	V _{DD} =3.96V	1.584	1.980	2.376	V
I _{CD}	CD pin Sink Current	V _{DS} =0.1V, V _{DD} =0.7V	2.0	30	μA	
		V _{DS} =0.5V, V _{DD} =1.5V	200.0	800.0		
R _D	Delay Resistance		0.5	1.0	2.0	MΩ
$\frac{\Delta -V_{DET}}{\Delta T_{opt}}$	Detector Threshold Temperature Coefficient	-30°C ≤ T _{opt} ≤ 85°C		±100		ppm/°C

(Note 1) Minimum Operating Voltage means the value of input voltage when output voltage maintains 0.1V or less, provided that in the case of Nch Open Drain Type Products, the pull-up resistance is set at 470kΩ, and the pull-up voltage is set at 5.0V.

RN5VD

• RN5VD45A/C

T_{opt}=25°C

Symbol	Item	Conditions	MIN.	TYP.	MAX.	Unit.
-V _{DET}	Detector Threshold		4.388	4.500	4.612	V
V _{HYS}	Detector Threshold Hysteresis		0.135	0.225	0.315	V
I _{SS}	Supply Current	V _{DD} =4.34V		5.5	11.0	μA
		V _{DD} =6.5V		1.3	3.9	
V _{DDH}	Maximum Operating Voltage				10	V
V _{DDL}	Minimum Operating Voltage (Note 1)	T _{opt} =25°C -30°C ≤ T _{opt} ≤ 85°C		0.55 0.65	0.70 0.80	V
I _{OUT}	Output Current	Nch	V _{DS} =0.05V, V _{DD} =0.7V	0.01	0.05	mA
			V _{DS} =0.5V, V _{DD} =1.5V	1.0	2.0	
		Pch	V _{DS} =-2.1V, V _{DD} =8.0V	1.5	3.0	mA
V _{TCD}	CD pin Threshold Voltage	V _{DD} =4.95V	1.980	2.475	2.970	V
I _{CD}	CD pin Sink Current	V _{DS} =0.1V, V _{DD} =0.7V	2.0	30	μA	
		V _{DS} =0.5V, V _{DD} =1.5V	200.0	800.0		
R _D	Delay Resistance		0.5	1.0	2.0	MΩ
$\frac{\Delta-V_{DET}}{\Delta T_{opt}}$	Detector Threshold Temperature Coefficient	-30°C ≤ T _{opt} ≤ 85°C		±100		ppm/°C

(Note 1) Minimum Operating Voltage means the value of input voltage when output voltage maintains 0.1V or less, provided that in the case of Nch Open Drain Type Products, the pull-up resistance is set at 470kΩ, and the pull-up voltage is set at 5.0V.

• RN5VD54A/C

T_{opt}=25°C

Symbol	Item	Conditions	MIN.	TYP.	MAX.	Unit.
-V _{DET}	Detector Threshold		5.265	5.400	5.535	V
V _{HYS}	Detector Threshold Hysteresis		0.162	0.270	0.378	V
I _{SS}	Supply Current	V _{DD} =5.2V		6.0	12.0	μA
		V _{DD} =7.4V		1.4	4.2	
V _{DDH}	Maximum Operating Voltage				10	V
V _{DDL}	Minimum Operating Voltage (Note 1)	T _{opt} =25°C -30°C≤T _{opt} ≤85°C		0.55 0.65	0.70 0.80	V
I _{OUT}	Output Current	Nch	V _{DS} =0.05V, V _{DD} =0.7V	0.01	0.05	mA
			V _{DS} =0.5V, V _{DD} =1.5V	1.0	2.0	
		Pch	V _{DS} =-2.1V, V _{DD} =8.0V	1.5	3.0	mA
V _{TCD}	CD pin Threshold Voltage	V _{DD} =5.94V	2.376	2.970	3.564	V
I _{CD}	CD pin Sink Current	V _{DS} =0.1V, V _{DD} =0.7V	2.0	30	μA	
		V _{DS} =0.5V, V _{DD} =1.5V	200.0	800.0		
R _D	Delay Resistance		0.5	1.0	2.0	MΩ
$\frac{\Delta-V_{DET}}{\Delta T_{opt}}$	Detector Threshold Temperature Coefficient	-30°C≤T _{opt} ≤85°C		±100		ppm/°C

(Note 1) Minimum Operating Voltage means the value of input voltage when output voltage maintains 0.1V or less, provided that in the case of Nch Open Drain Type Products, the pull-up resistance is set at 470kΩ, and the pull-up voltage is set at 5.0V.

ELECTRICAL CHARACTERISTICS BY DETECTOR THRESHOLD

• RN5VD09A/C to RN5VD39A/C

Part Number.	Detector Threshold			Hysteresis			Supply Current 1			Supply Current 2			Output Current 1			Output Current 2															
	-V _{DET} (V)			V _{HYS} (V)			I _{SS1} (μA)			I _{SS2} (μA)			I _{OUT1} (mA)			I _{OUT2} (mA)															
	MIN.	TYP.	MAX.	MIN.	TYP.	MAX.	conditions	TYP.	MAX.	conditions	TYP.	MAX.	conditions	MIN.	TYP.	conditions	MIN.	TYP.													
RN5VD09A/C	0.878	0.900	0.922	0.027	0.045	0.063	V _{DD} = (-V _{DET}) -0.10V	1.5	3.7	0.9	2.7	Nch	0.01	0.05	Nch	V _{DD} = 0.85V	0.05	0.5													
RN5VD10A/C	0.975	1.000	1.025	0.030	0.050	0.070																									
RN5VD11A/C	1.073	1.100	1.127	0.033	0.055	0.077													1.8	4.5											
RN5VD12A/C	1.170	1.200	1.230	0.036	0.060	0.084																									
RN5VD13A/C	1.268	1.300	1.332	0.039	0.065	0.091													2.0	5.0	1.0	3.0	V _{DD} = 1.0V	0.2	1.0						
RN5VD14A/C	1.365	1.400	1.435	0.042	0.070	0.098																									
RN5VD15A/C	1.463	1.500	1.537	0.045	0.075	0.105													2.5	5.0											
RN5VD16A/C	1.560	1.600	1.640	0.048	0.080	0.112																									
RN5VD17A/C	1.658	1.700	1.742	0.051	0.085	0.119													3.0	6.0	V _{DD} = (-V _{DET}) +2.0V	1.1	3.3	0.05V	0.01	0.05	Nch	V _{DSS} = 0.5V	V _{DD} = 1.5V	1.0	2.0
RN5VD18A/C	1.755	1.800	1.845	0.054	0.090	0.126																									
RN5VD19A/C	1.853	1.900	1.947	0.057	0.095	0.133													3.5	7.0											
RN5VD20A/C	1.950	2.000	2.050	0.060	0.100	0.140																									
RN5VD21A/C	2.048	2.100	2.152	0.063	0.105	0.147													4.0	8.0	1.2	3.6									
RN5VD22A/C	2.145	2.200	2.255	0.066	0.110	0.154																									
RN5VD23A/C	2.243	2.300	2.357	0.069	0.115	0.161													4.5	9.0											
RN5VD24A/C	2.340	2.400	2.460	0.072	0.120	0.168																									
RN5VD25A/C	2.438	2.500	2.562	0.075	0.125	0.175													V _{DD} = (-V _{DET}) -0.13V	4.5	9.0										
RN5VD26A/C	2.535	2.600	2.665	0.078	0.130	0.182																									
RN5VD27A/C	2.633	2.700	2.767	0.081	0.135	0.189													4.5	9.0											
RN5VD28A/C	2.730	2.800	2.870	0.084	0.140	0.196																									
RN5VD29A/C	2.828	2.900	2.972	0.087	0.145	0.203	4.5	9.0																							
RN5VD30A/C	2.925	3.000	3.075	0.090	0.150	0.210																									
RN5VD31A/C	3.023	3.100	3.177	0.093	0.155	0.217	4.5	9.0																							
RN5VD32A/C	3.120	3.200	3.280	0.096	0.160	0.224																									
RN5VD33A/C	3.218	3.300	3.382	0.099	0.165	0.231	4.5	9.0																							
RN5VD34A/C	3.315	3.400	3.485	0.102	0.170	0.238																									
RN5VD35A/C	3.413	3.500	3.587	0.105	0.175	0.245	4.5	9.0																							
RN5VD36A/C	3.510	3.600	3.690	0.108	0.180	0.252																									
RN5VD37A/C	3.608	3.700	3.792	0.111	0.185	0.259	4.5	9.0																							
RN5VD38A/C	3.705	3.800	3.895	0.114	0.190	0.266																									
RN5VD39A/C	3.803	3.900	3.997	0.117	0.195	0.273	4.5	9.0																							

(Note) Refer to the previously defined "Minimum Operating Voltage".

Condition 1 : T_{opt}=25°C

Condition 2 : -30°C ≤ T_{opt} ≤ 85°C

T_{opt}=25°C

Output Current 3			Minimum Operating Voltage		C _D Pin Threshold Voltage			C _D Pin Output Current 1			C _D Pin Output Current 2			Delay Resistance			Detector Threshold Tempco.					
I _{out3} (mA)			V _{DDL} (V)		V _{TCD} (V)			I _{cd1} (μA)			I _{cd2} (μA)			R _D (MΩ)			$\frac{\Delta-V_{DET}}{\Delta T_{opt}}$ (ppm/°C)					
conditions	MIN.	TYP.	TYP.	MAX.	conditions	MIN.	TYP.	MAX.	conditions	MIN.	TYP.	conditions	MIN.	TYP.	MIN.	TYP.	MAX.	conditions	TYP.			
P _{ch} V _{DS} = -2.1V V _{DD} = 4.5V	1.0	2.0	(Note1) Condition1 0.55	(Note1) Condition1 0.70	conditions	V _{DDX}	V _{DDX}	V _{DDX}	conditions	MIN.	TYP.	conditions	V _{DD} = 0.85V	10	100	MIN.	TYP.	MAX.	conditions	TYP.		
						0.3	0.5	0.7					V _{DD} = 1.0V	50	200							
						V _{DDX}	V _{DDX}	V _{DDX}					V _{DD} = 1.5V	200	800							
						0.35	0.5	0.65														
			Condition2 0.65	Condition2 0.80	V _{DD} = (-V _{DET}) × 1.1V				V _{DS} = 0.1V	2.0	30	V _{DS} = 0.5V				0.5	1.0	2.0	-30°C ≤ T _{opt} ≤ 85°C	±100		
									V _{DD} = 0.7V													
						V _{DDX}	V _{DDX}	V _{DDX}														
						0.4	0.5	0.6														

RN5VD

• RN5VD40A/C to RN5VD60A/C

Part Number.	Detector Threshold			Hysteresis			Supply Current 1			Supply Current 2			Output Current 1			Output Current 2		
	-V _{DET} (V)			V _{HYS} (V)			I _{SS1} (μA)			I _{SS2} (μA)			I _{OUT1} (mA)			I _{OUT2} (mA)		
	MIN.	TYP.	MAX.	MIN.	TYP.	MAX.	conditions	TYP.	MAX.	conditions	TYP.	MAX.	conditions	MIN.	TYP.	conditions	MIN.	TYP.
RN5VD40A/C	3.900	4.000	4.100	0.120	0.200	0.280	V _{DD} = (-V _{DET}) -0.16V	5.0	10.0	V _{DD} = (-V _{DET}) +2.0V	1.3	3.9	N _{ch} V _{DS} = 0.05V V _{DD} = 0.7V	0.01	0.05	N _{ch} V _{DS} = 0.5V V _{DD} = 1.5V	1.0	2.0
RN5VD41A/C	3.998	4.100	4.202	0.123	0.205	0.287												
RN5VD42A/C	4.095	4.200	4.305	0.126	0.210	0.294												
RN5VD43A/C	4.193	4.300	4.407	0.129	0.215	0.301		5.5	11.0									
RN5VD44A/C	4.290	4.400	4.510	0.132	0.220	0.308												
RN5VD45A/C	4.388	4.500	4.612	0.135	0.225	0.315												
RN5VD46A/C	4.485	4.600	4.715	0.138	0.230	0.322		V _{DD} = (-V _{DET}) -0.20V	6.0		12.0							
RN5VD47A/C	4.583	4.700	4.817	0.141	0.235	0.329												
RN5VD48A/C	4.680	4.800	4.920	0.144	0.240	0.336												
RN5VD49A/C	4.778	4.900	5.022	0.147	0.245	0.343	6.5		13.0									
RN5VD50A/C	4.875	5.000	5.125	0.150	0.250	0.350												
RN5VD51A/C	4.973	5.100	5.227	0.153	0.255	0.357												
RN5VD52A/C	5.070	5.200	5.330	0.156	0.260	0.364	6.5		13.0									
RN5VD53A/C	5.168	5.300	5.432	0.159	0.265	0.371												
RN5VD54A/C	5.265	5.400	5.535	0.162	0.270	0.378												
RN5VD55A/C	5.363	5.500	5.637	0.165	0.275	0.385												
RN5VD56A/C	5.460	5.600	5.740	0.168	0.280	0.392												
RN5VD57A/C	5.558	5.700	5.842	0.171	0.285	0.399												
RN5VD58A/C	5.655	5.800	5.945	0.174	0.290	0.406	6.5	13.0										
RN5VD59A/C	5.753	5.900	6.047	0.177	0.295	0.413												
RN5VD60A/C	5.850	6.000	6.150	0.180	0.300	0.420												

(Note) Refer to the previously defined "Minimum Operating Voltage".

Condition 1 : T_{opt}=25°C

Condition 2 : -30°C≤T_{opt}≤85°C

T_{opt}=25°C

Output Current 3			Minimum Operating Voltage		C _D Pin Threshold Voltage				C _D Pin Output Current 1			C _D Pin Output Current 2			Delay Resistance			Detector Threshold Tempo.		
I _{OUT3} (mA)			V _{DDL} (V)		V _{TCD} (V)				I _{CD1} (μA)			I _{OUT1} (mA)			I _{OUT2} (mA)			$\frac{\Delta-V_{DET}}{\Delta T_{opt}}$ (ppm/°C)		
conditions	MIN.	TYP.	TYP.	MAX.	conditions	MIN.	TYP.	MAX.	conditions	MIN.	TYP.	conditions	MIN.	TYP.	conditions	TYP.	MAX.	conditions	TYP.	
P _{ch}			(Note1) Condition1	(Note1) Condition1																
V _{DS} = -2.1V	1.5	3.0	0.55	0.70	V _{DD} = (-V _{DET}) ×1.1V	V _{DD} × 0.4	V _{DD} × 0.5	V _{DD} × 0.6V	V _{DS} = 0.1V	2.0	30	V _{DS} = 0.5V	V _{DD} = 1.5V	200	800	0.5	1.0	2.0	-30°C ≤ T _{opt} ≤85°C	±100
V _{DD} = 8.0V			Condition2 0.65	Condition2 0.80					V _{DD} = 0.7V											

OPERATION

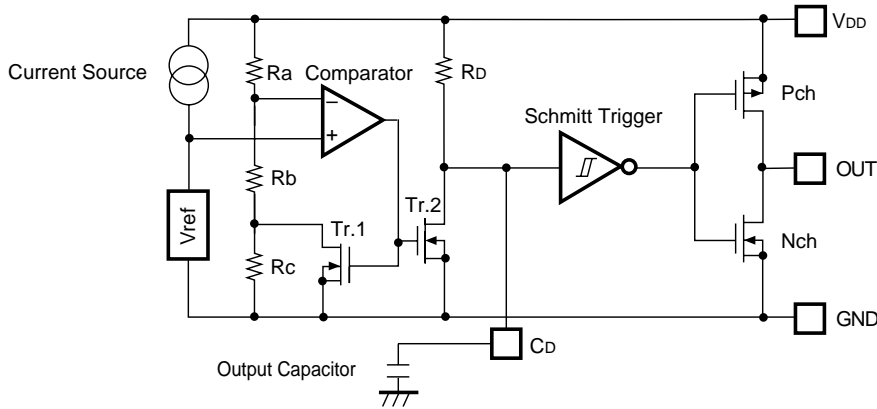

FIG. 1 Block Diagram

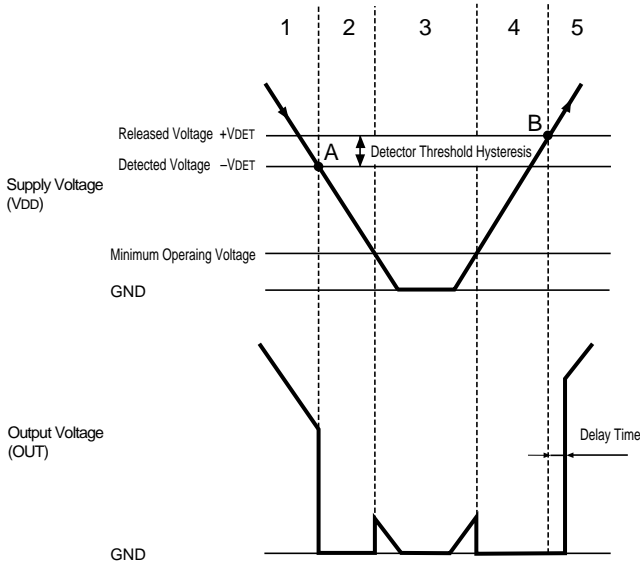

FIG. 2 Operation Diagram

Step	Step 1	Step 2	Step 3	Step 4	Step 5
Comparator (-) Pin Input Voltage	I	II	II	II	I
Comparator Output	L	H	Indefinite	H	L
Tr. 1, 2	OFF	ON	Indefinite	ON	OFF
Output Tr.	Nch	OFF	Indefinite	ON	OFF
	Pch	ON	OFF	Indefinite	OFF

$$I. \frac{R_b + R_c}{R_a + R_b + R_c} \cdot V_{DD}$$

$$II. \frac{R_b}{R_a + R_b} \cdot V_{DD}$$

- Step 1. Output Voltage is equal to Pull-up Voltage.
- Step 2. When Input Voltage (V_{DD}) reaches the state of $V_{ref} \geq V_{DD} \cdot (R_b + R_c) / (R_a + R_b + R_c)$ at Point A (Detected Voltage $-V_{DET}$), the output of Comparator is reversed, so that Output Voltage becomes GND. Discharging is performed from C_d pin connected to External Capacitor. No delay time is generated.
- Step 3. Output Voltage becomes indefinite when Power Source Voltage (V_{DD}) is smaller than Minimum Operating Voltage. When the output is pulled up, V_{DD} is output.
- Step 4. Output Voltage becomes equal to GND.
- Step 5. When Input Voltage (V_{DD}) reaches the state of $V_{ref} \leq V_{DD} \cdot R_b / (R_a + R_b)$ at Point B (Released Voltage $+V_{DET}$), the output of Comparator is reversed, and the External Capacitor is charged through C_d pin, so that Output Voltage becomes equal to Pulled-up Voltage after a delay time $t_d (=0.69 \times 10^6 \times C_d)$.

• Output Delay Operation

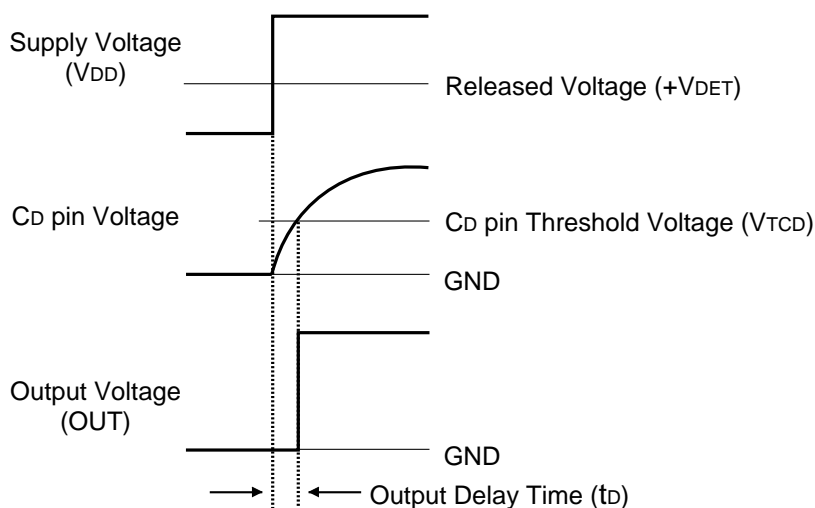

When the Supply Voltage crosses the Released Voltage ($+V_{DET}$) from a low value to a value higher than the Released Voltage ($+V_{DET}$), the CD pin Voltage starts to increase (starts to charge the external capacitor).

The Output Voltage is maintained at “L” level until the CD pin Voltage reaches to V_{TCD} (CD pin Threshold Voltage) after that the Output Voltage is reversed to “H” state.

The time period from beginning of charging capacitor to Output Voltage reversing represents the Output Delay (t_D).

• Output Delay Time

Delay time (t_D) can be set accordance with the capacitance C_D of external capacitor as below

$$t_D = 0.69 \times 10^6 \times C_D \text{ (s)}$$

TEST CIRCUITS

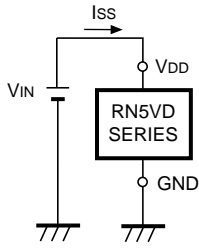

FIG. 3 Supply Current test Circuit

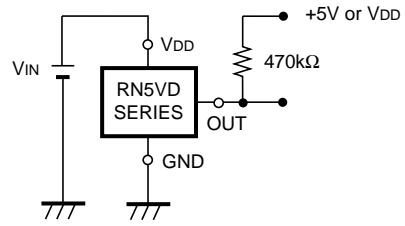

FIG. 4 Detector Threshold Test Circuit

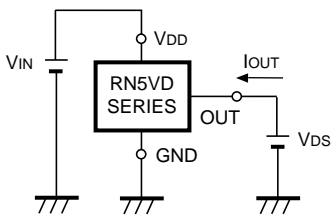

FIG. 5 Nch Driver Output Current Test Circuit

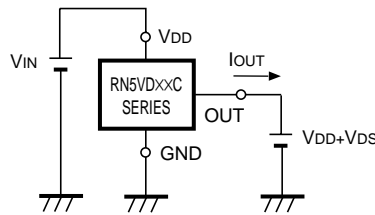

FIG. 6 Pch Driver Output Current Test Circuit

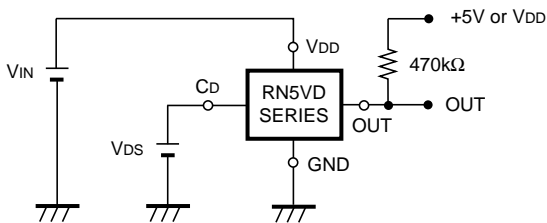

FIG. 7 Cd pin Threshold Voltage Test Circuit

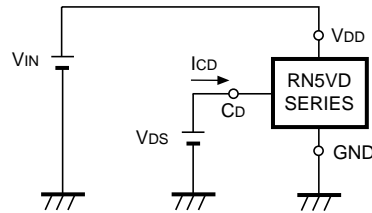

FIG. 8 Cd pin Sink Current Test Circuit

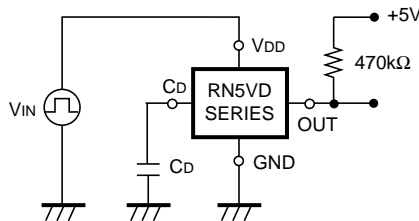
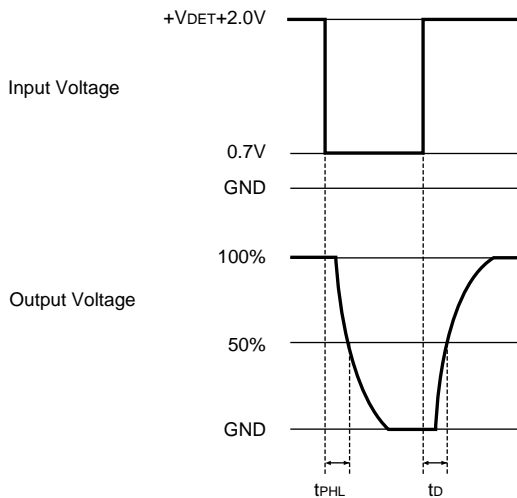
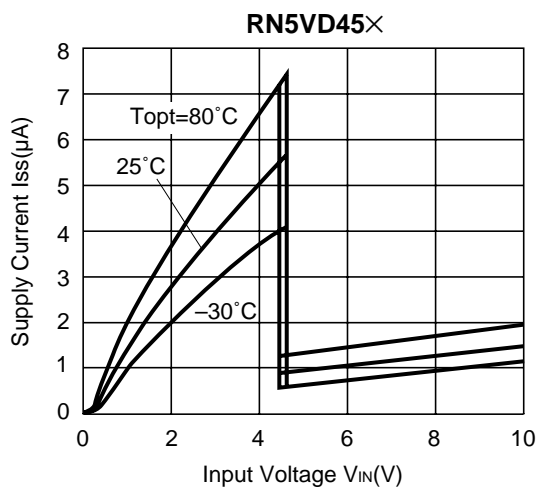
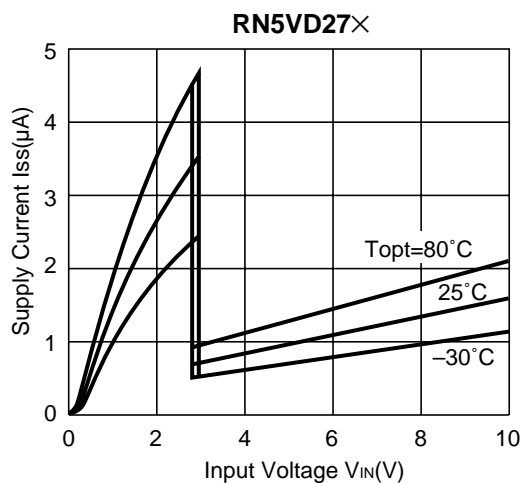
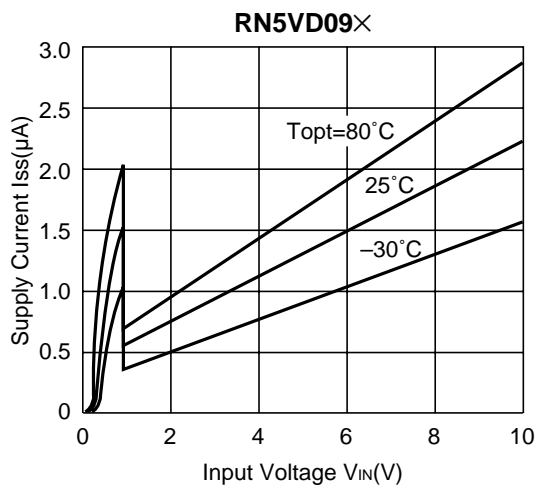

FIG. 9 Output Delay Time Test Circuit

*) at FIG.4,7,9. CMOS Output Type does not need a pull-up resistor.

TYPICAL CHARACTERISTICS

1) Supply Current vs. Input Voltage



2) Detector Threshold vs. Temperature

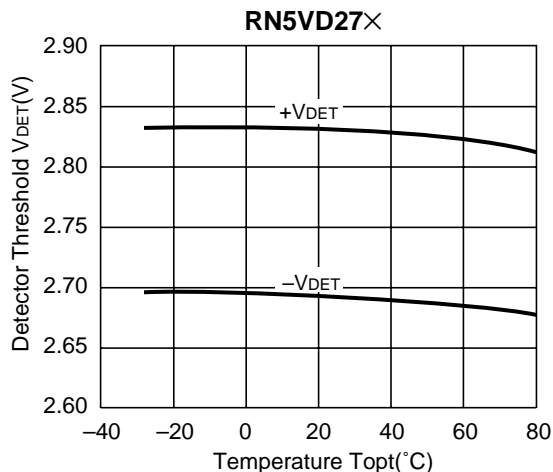
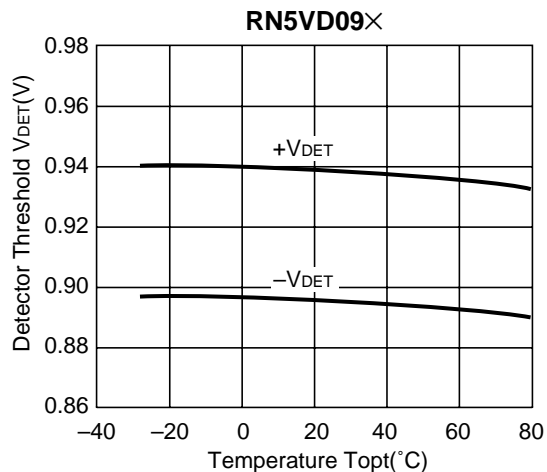

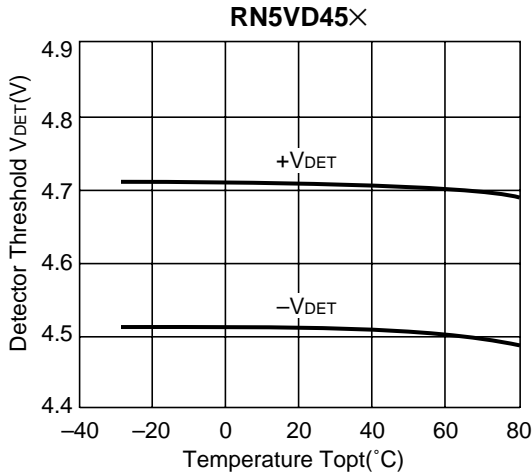

3) Output Voltage vs. Input Voltage

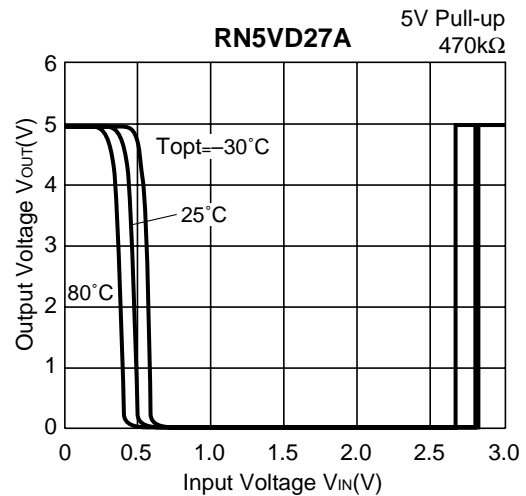
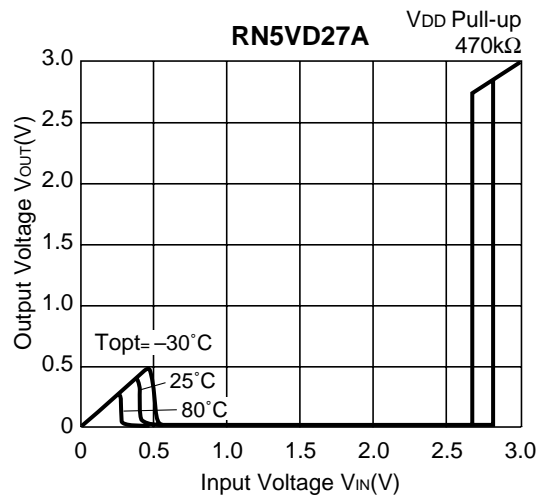
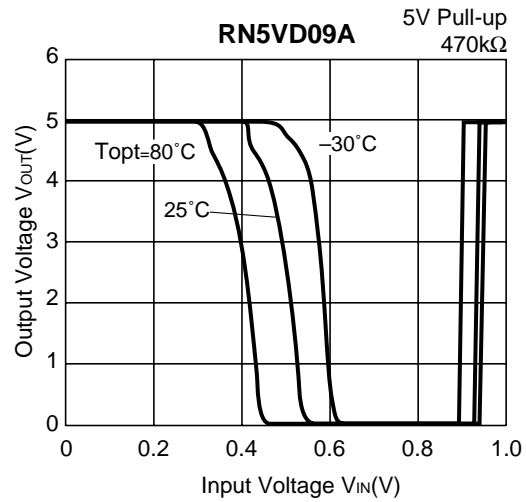
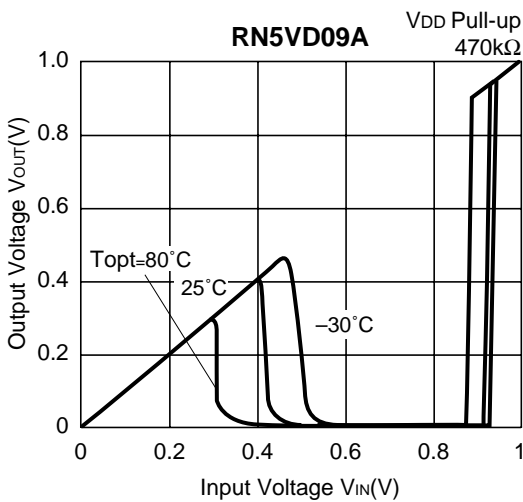

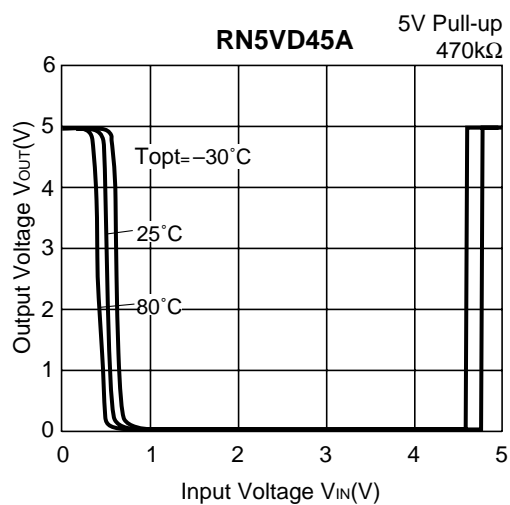
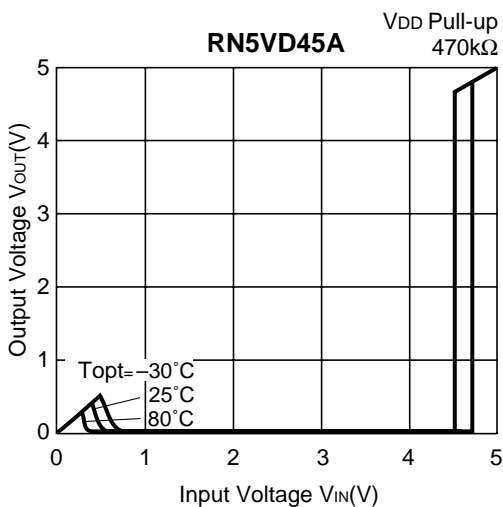

4) Nch Driver Output Current vs. V_{DS}

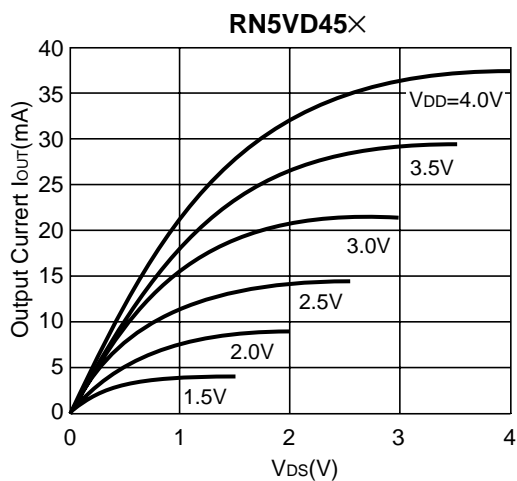
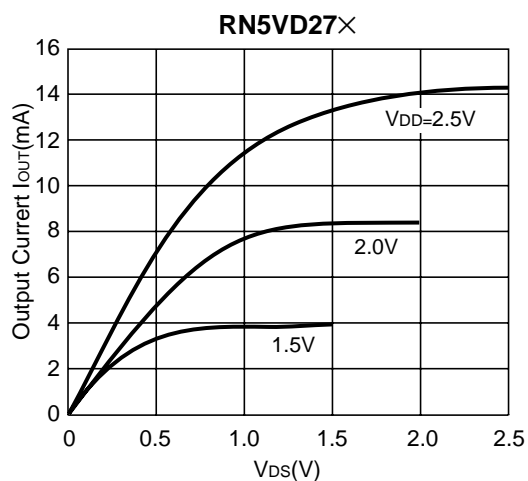
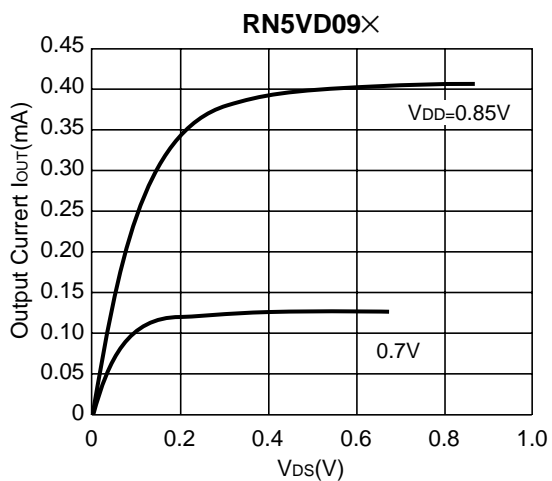

5) Nch Driver Output Current vs. Input Voltage

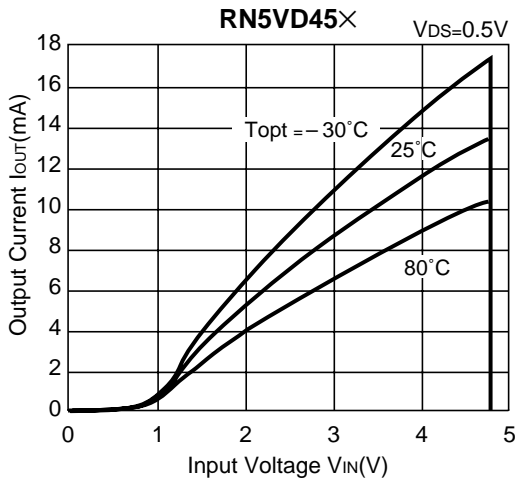
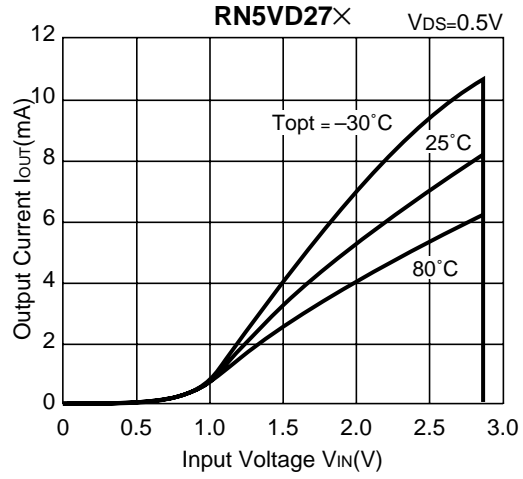
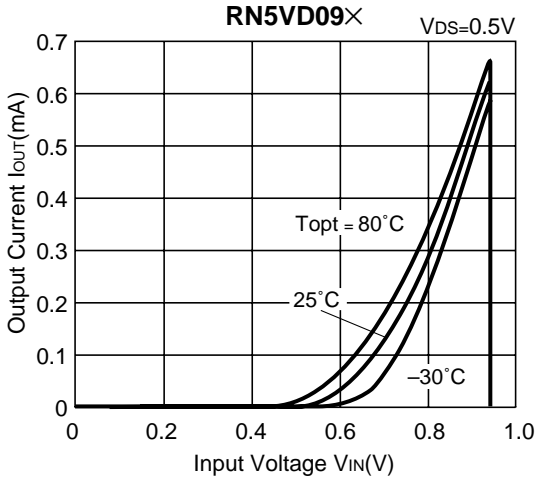

6) Pch Driver Output Current vs. Input Voltage

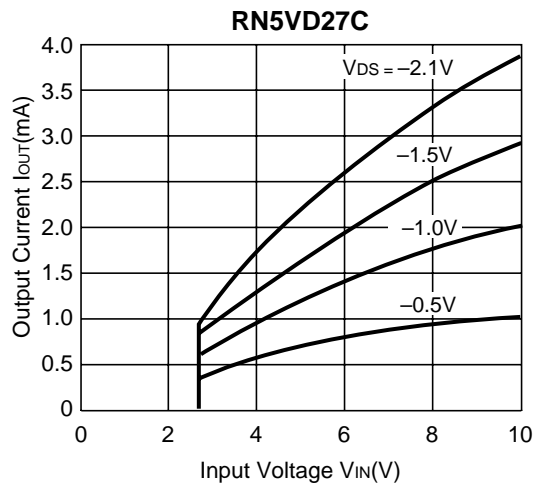
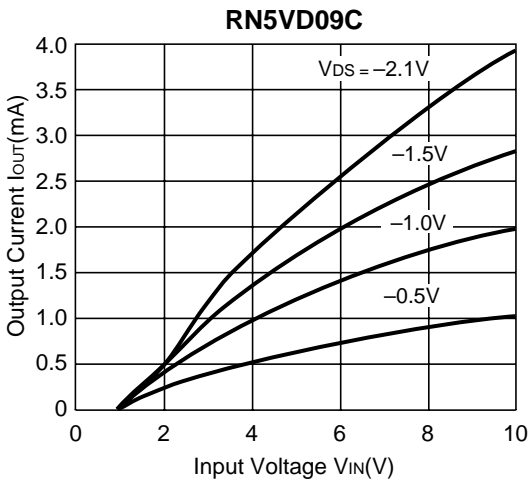

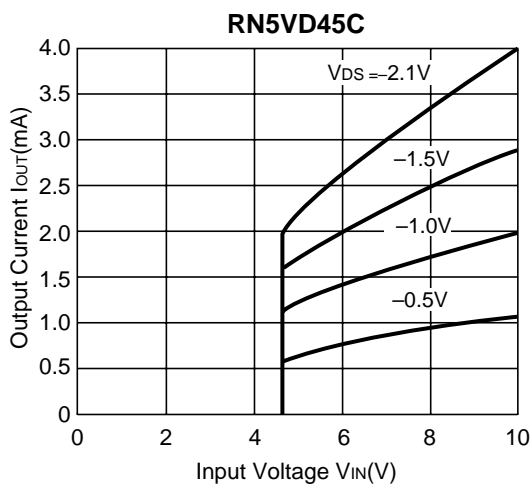

7) C_D pin Threshold Voltage vs. Temperature

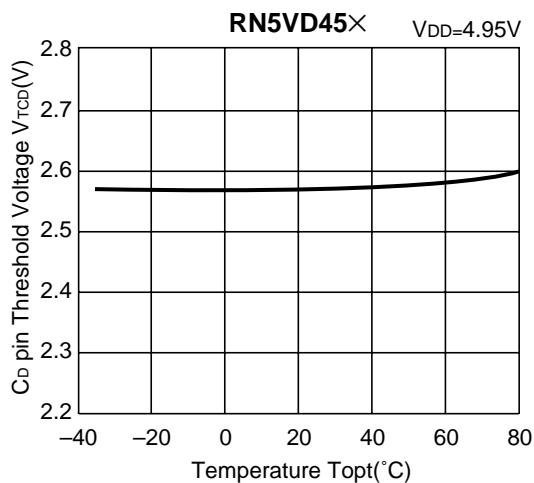
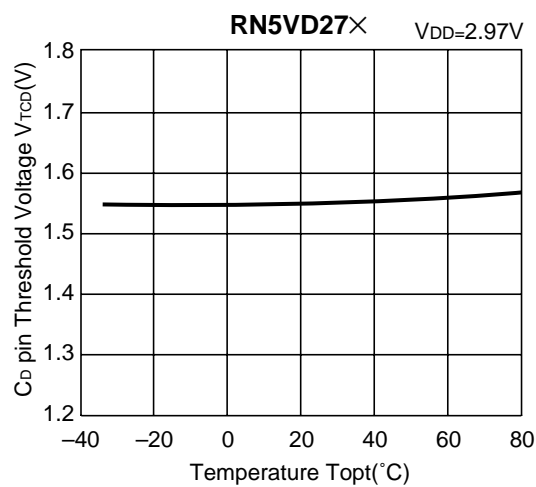
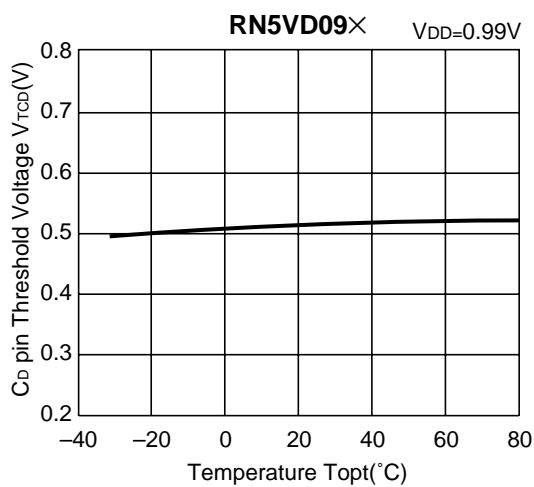

8) Cd pin Sink Current vs. Input Voltage

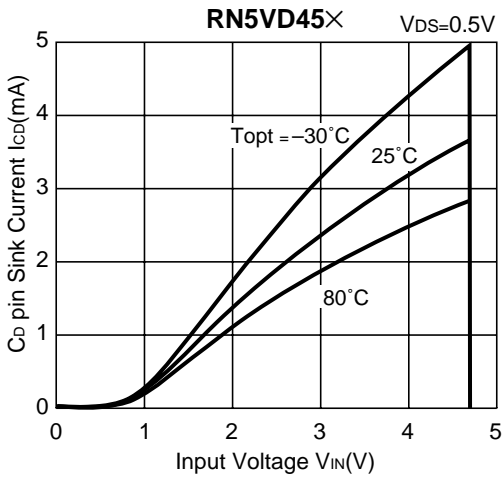
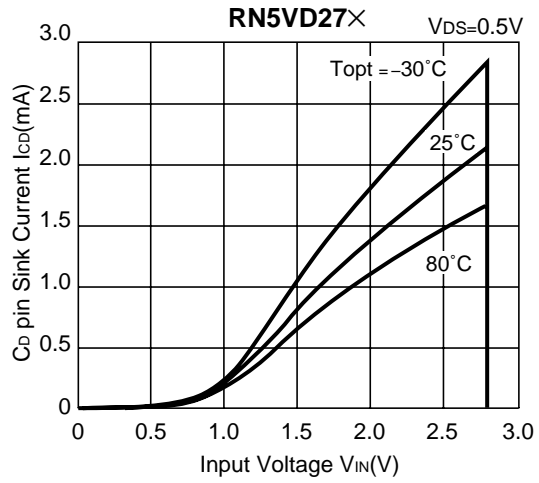
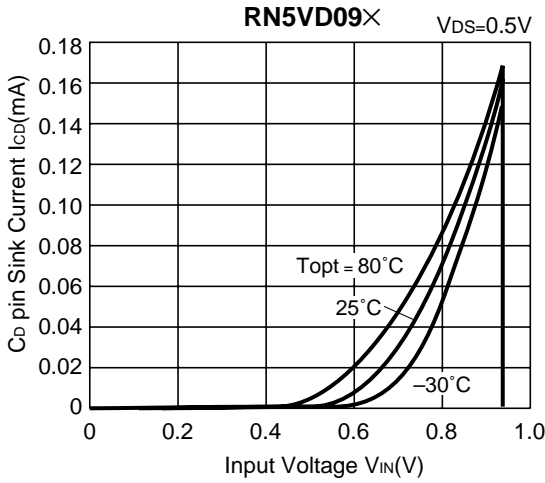

9) Cd pin Sink Current vs. Cd pin Voltage

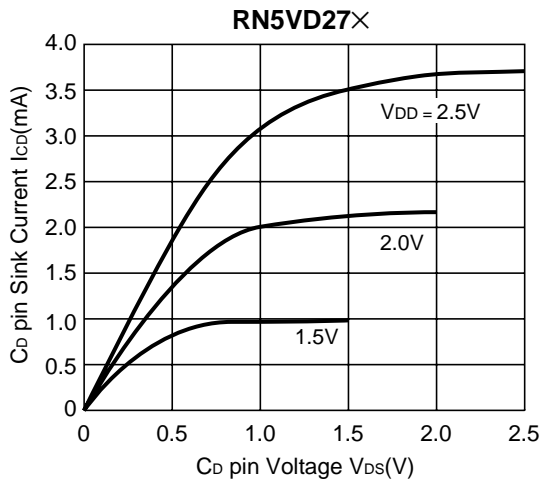
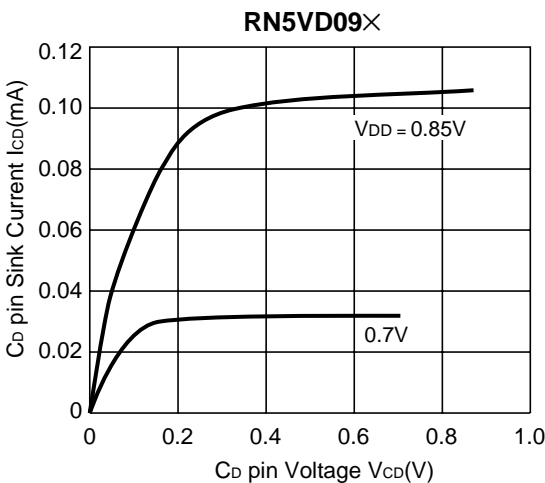

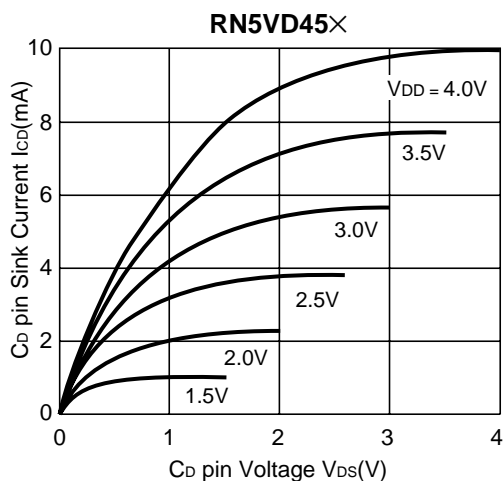

10) Output delay Time vs. External Capacitance

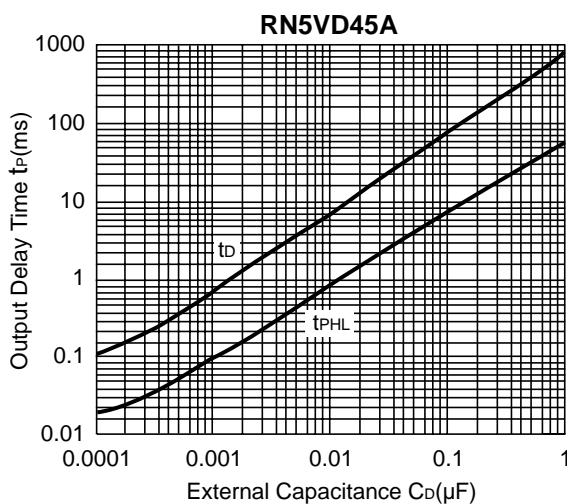
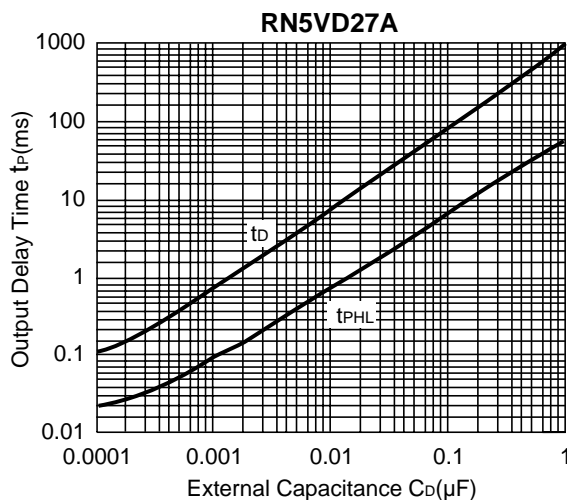
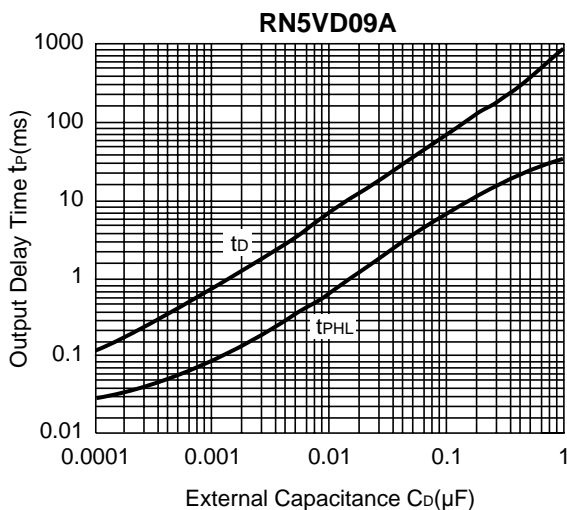

11) Delay Resistance vs. Temperature

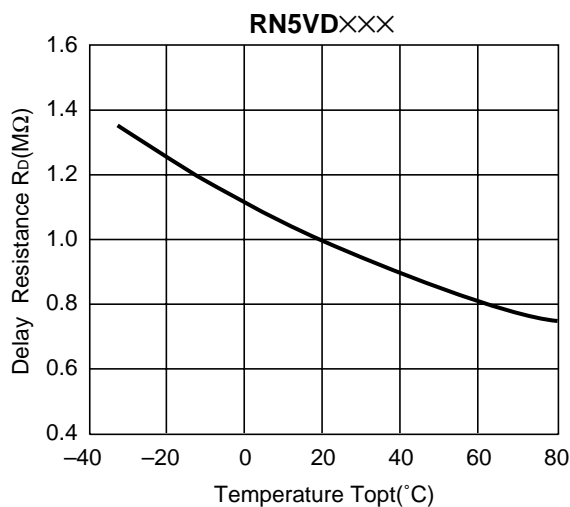

TYPICAL APPLICATIONS

• RN5VD××A CPU Reset Circuit (Nch Open Drain Output)

(1) Input Voltage to RN5VD××A is the same as the input voltage to CPU.

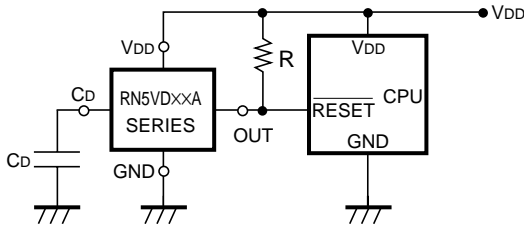

(2) Input Voltage to RN5VD××A is different from the input voltage to CPU.

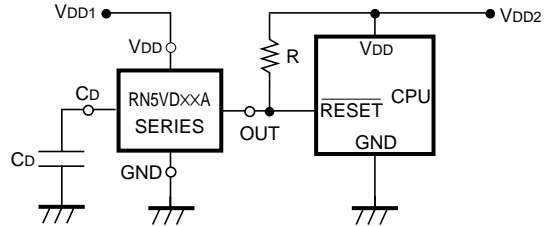

• RN5VD××C CPU Reset Circuit (CMOS Output)

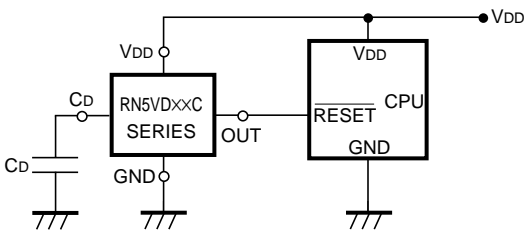

• Memory Back-up Circuit

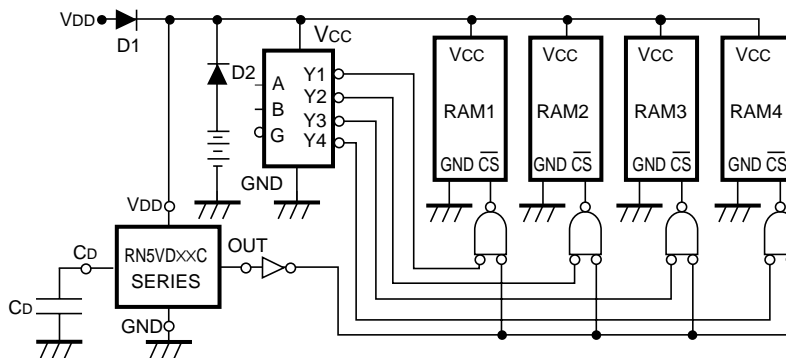

• Manual Reset Circuit

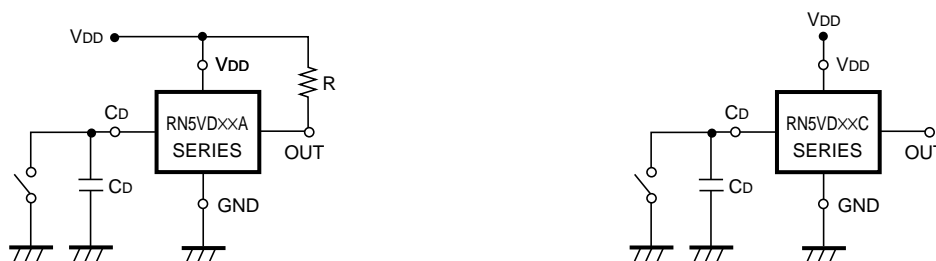

APPLICATION HINTS

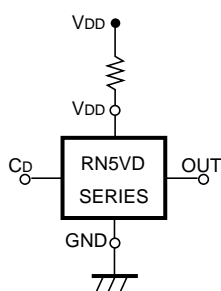

FIG. 10

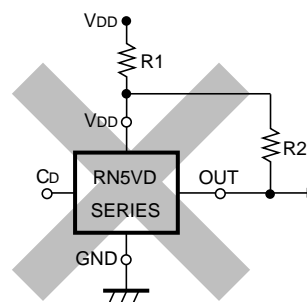

FIG. 11

1. When RN5VDxxC (CMOS Output) is used in FIG.10, this IC may oscillate by the through-type current at the detection when impedance is connected between Power Source VDD and RN5VD VDD Pin. When RN5VDxxA (Nch Open Drain Output) is used in FIG.10, and R becomes excessively large, Detector Threshold may be varied because of the voltage drop of the supply current in the IC itself.
2. The connection as shown in FIG. 11 may cause the oscillation in both RN5VDxxC (CMOS Output) and RN5VDxxA (Nch Open Drain Output)

Компания «Океан Электроники» предлагает заключение долгосрочных отношений при поставках импортных электронных компонентов на взаимовыгодных условиях!

Наши преимущества:

- Поставка оригинальных импортных электронных компонентов напрямую с производств Америки, Европы и Азии, а так же с крупнейших складов мира;
- Широкая линейка поставок активных и пассивных импортных электронных компонентов (более 30 млн. наименований);
- Поставка сложных, дефицитных, либо снятых с производства позиций;
- Оперативные сроки поставки под заказ (от 5 рабочих дней);
- Экспресс доставка в любую точку России;
- Помощь Конструкторского Отдела и консультации квалифицированных инженеров;
- Техническая поддержка проекта, помощь в подборе аналогов, поставка прототипов;
- Поставка электронных компонентов под контролем ВП;
- Система менеджмента качества сертифицирована по Международному стандарту ISO 9001;
- При необходимости вся продукция военного и аэрокосмического назначения проходит испытания и сертификацию в лаборатории (по согласованию с заказчиком);
- Поставка специализированных компонентов военного и аэрокосмического уровня качества (Xilinx, Altera, Analog Devices, Intersil, Interpoint, Microsemi, Actel, Aeroflex, Peregrine, VPT, Syfer, Eurofarad, Texas Instruments, MS Kennedy, Miteq, Cobham, E2V, MA-COM, Hittite, Mini-Circuits, General Dynamics и др.);

Компания «Океан Электроники» является официальным дистрибьютором и эксклюзивным представителем в России одного из крупнейших производителей разъемов военного и аэрокосмического назначения «JONHON», а так же официальным дистрибьютором и эксклюзивным представителем в России производителя высокотехнологичных и надежных решений для передачи СВЧ сигналов «FORSTAR».



JONHON

«JONHON» (основан в 1970 г.)

Разъемы специального, военного и аэрокосмического назначения:

(Применяются в военной, авиационной, аэрокосмической, морской, железнодорожной, горно- и нефтедобывающей отраслях промышленности)

«FORSTAR» (основан в 1998 г.)

ВЧ соединители, коаксиальные кабели,
кабельные сборки и микроволновые компоненты:

(Применяются в телекоммуникациях гражданского и специального назначения, в средствах связи, РЛС, а так же военной, авиационной и аэрокосмической отраслях промышленности).



Телефон: 8 (812) 309-75-97 (многоканальный)

Факс: 8 (812) 320-03-32

Электронная почта: ocean@oceanchips.ru

Web: <http://oceanchips.ru/>

Адрес: 198099, г. Санкт-Петербург, ул. Калинина, д. 2, корп. 4, лит. А