

R2, R3, R4

Industrial Electromagnetic Relays



- Compact size
- Relays of general application
- Cadmium - free contacts
- AC and DC coils
- For plug-in sockets, 35 mm rail mount or on panel mounting *
- WT (mechanical indicator + lockable front test button) - standard features of relays for plug-in sockets. Relays may be provided with the test buttons (no latching) and plugs (see page 115)
- AUCOTEAM GmbH Berlin - railway standards.

Contact Data

	R2	R3	R4
Number and type of contacts	DPDT	3PDT	4PDT
Contact material	AgNi**	AgNi**	AgNi**
Rated / max. switching voltage AC	250 V / 440 V	250 V / 440 V	250 V / 250 V
Min. switching voltage	10 V	10 V	10 V
Rated load (capacity)			
AC1	12 A / 250 V AC	10 A / 250 V AC	6 A / 250 V AC
AC15	3 A / 120 V; 1.5 A / 240 V (B300)	3 A / 120 V; 1.5 A / 240 V (B300)	1.5 A / 120 V; 0.75 A / 240 V (C300)
AC3	370 W (single-phase motor)	370 W (single-phase motor)	125 W (single-phase motor)
DC1	12 A / 24 V DC (see Fig. 3.1)	10 A / 24 V DC (see Fig. 3.2)	6 A / 24 V DC (see Fig. 3.3)
DC13	0.22 A / 120 V; 0.1 A / 250 V (R300)	0.22 A / 120 V; 0.1 A / 250 V (R300)	0.22 A / 120 V; 0.1 A / 250 V (R300)
Min. switching current	5 mA	5 mA	5 mA
Max. inrush current	24 A	20 A	12 A
Rated current	12 A	10 A	6 A
Max. breaking capacity AC1	3000 VA	2500 VA	1500 VA
Min. breaking capacity	0.3 W	0.3 W	0.3 W
Contact resistance	≤ 100 mΩ	≤ 100 mΩ	≤ 100 mΩ
Max. operating frequency			
• at rated load AC1	1200 cycles/hour	1200 cycles/hour	1200 cycles/hour
• no load	18000 cycles/hour	18000 cycles/hour	18000 cycles/hour

Coil Data

Rated voltage	50/60 Hz AC	6 ... 240 V	6 ... 240 V	6 ... 240 V
	DC	5 ... 220 V	5 ... 220 V	5 ... 220 V
Must release voltage		AC: ≥ 0.2 U _n ; DC: ≥ 0.1 U _n	AC: ≥ 0.2 U _n ; DC: ≥ 0.1 U _n	AC: ≥ 0.2 U _n ; DC: ≥ 0.1 U _n
Operating range of supply voltage		see page 54	see page 54	see page 54
Rated power consumption	AC	1.6 VA	1.6 VA	1.6 VA
	DC	0.9 W	0.9 W	0.9 W

Insulation

Insulation rated voltage		250 V AC	250 V AC	250 V AC
Rated surge voltage		4000 V 1.2 / 50 μs	with AC coils: 2500 V 1.2 / 50 μs with DC coils: 4000 V 1.2 / 50 μs	2500 V 1.2 / 50 μs
Overvoltage category		III	III	II
Insulation pollution degree		3	3	2
Dielectric strength				
• between coil and contacts		2500 V AC type of insulation: basic	2500 V AC type of insulation: basic	2500 V AC type of insulation: basic
• contact clearance		1500 V AC type of clearance: micro-disco.	1500 V AC type of clearance: micro-disco.	1500 V AC type of clearance: micro-disco.
• pole - pole		2500 V AC type of insulation: basic	2500 V AC type of insulation: basic	2500 V AC type of insulation: basic
Contact - coil distance				
• clearance		≥ 2.5 mm	≥ 2.5 mm	≥ 1.6 mm
• creepage		≥ 4 mm	≥ 4 mm	≥ 3.2 mm

General data

Operating / release time (typical)		AC: 10 ms / 8 ms; DC: 13 ms / 3 ms	AC: 10 ms / 8 ms; DC: 13 ms / 3 ms	AC: 10 ms / 8 ms; DC: 13 ms / 3 ms
Electrical life				
• resistive AC1		> 10 ⁵ ; 12 A. 250 V AC see Fig. 2.1	> 10 ⁵ ; 10 A. 250 V AC see Fig. 2.2	> 10 ⁵ ; 6 A. 250 V AC see Fig. 2.3
• cosφ				
Mechanical life (cycles)		> 2 x 10 ⁷	> 2 x 10 ⁷	> 2 x 10 ⁷
Dimensions (L x W x H)		27.5 x 21.2 x 35.6 mm	27.5 x 21.2 x 35.6 mm	27.5 x 21.2 x 35.6 mm
Weight		35 g	35 g	35 g
Ambient temperature				
• storage		-40...+85 °C	-40...+85 °C	-40...+85 °C
• operating		AC: -40...+55 °C; DC: -40...+70 °C	AC: -40...+55 °C; DC: -40...+70 °C	AC: -40...+55 °C; DC: -40...+70 °C
Cover protection category		IP 40 PN-EN 60529	IP 40 PN-EN 60529	IP 40 PN-EN 60529
Environmental protection		RTI PN-EN 116000-3	RTI PN-EN 116000-3	RTI PN-EN 116000-3
Shock resistance (NO/NC)		10 g / 5 g	10 g / 5 g	10 g / 5 g
Vibration resistance		5 g 10...150 Hz	5 g 10...150 Hz	5 g 10...150 Hz
Solder bath temperature		max. 270 °C	-	max. 270 °C
Soldering time		max. 5 s	-	max. 5 s

* PCB or threaded bolt versions contact Altech Corp.

** Other contact materials (eg. gold plated) available, contact Altech Corp.

R2, R3, R4 Industrial Electromagnetic Relays



R2 (DPDT)



CONNECTION DIAGRAM



DIMENSIONS



LOAD CHARTS

Electrical life at AC resistive load. Switching frequency: 1200 cycles/hour **Fig. 1.1**



Electrical life reduction factor at AC inductive load **Fig. 2.1**



Max. DC resistive load breaking capacity **Fig. 3.1**



R2, R3, R4 Industrial Electromagnetic Relays



R3 (3PDT)



CONNECTION DIAGRAM



DIMENSIONS



LOAD CHARTS

Electrical life at AC resistive load.
Switching frequency: 1200 cycles/hour **Fig. 1.2**



Electrical life reduction factor
at AC inductive load **Fig. 2.2**

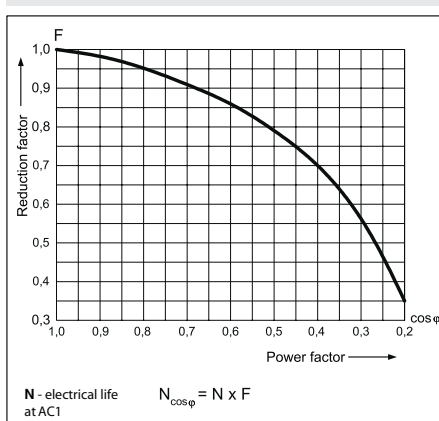

Max. DC breaking capacity
A - resistive load DC1
B - inductive load L/R = 40 ms **Fig. 3.2**

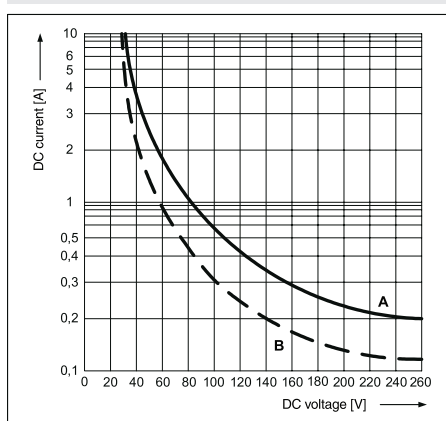

R2, R3, R4 Industrial Electromagnetic Relays



R4 (4PDT)



CONNECTION DIAGRAM



DIMENSIONS



LOAD CHARTS

Electrical life at AC resistive load. Switching frequency: 1200 cycles/hour **Fig. 3.1**

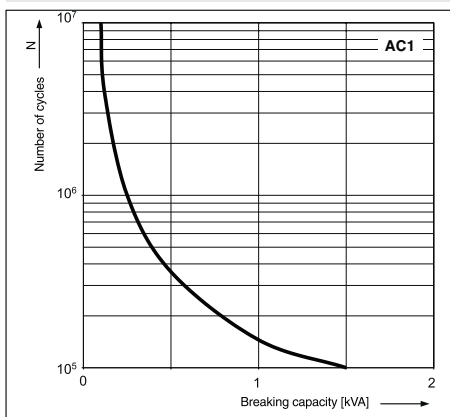

Electrical life reduction factor at AC inductive load **Fig. 2.3**

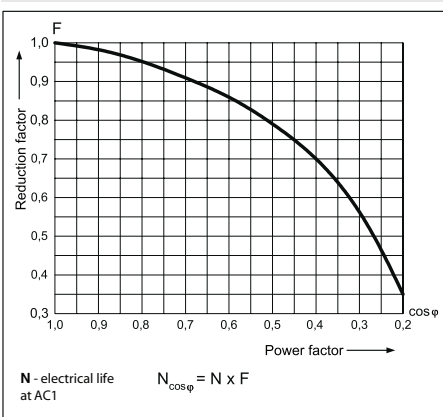

Max. DC breaking capacity **Fig. 3.3**
A - resistive load DC1
B - inductive load L/R = 40 ms

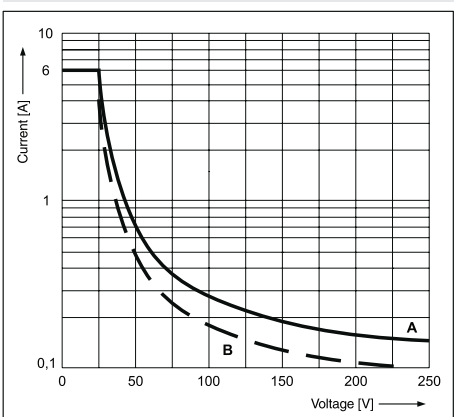

R2, R3, R4

Industrial Electromagnetic Relays

R2 DPDT AC 50/60Hz & DC coil

Part Number	Coil Voltage (V)	Coil Type	Coil resistance at 20 °C in Ω	Coil operating range		Options*	
				min. (at 20°C)	max. (at 55°C)	WT	WTL
R2N-2012-23-1012-WT	12	DC	160	9.6	13.2	x	
▶ R2N-2012-23-1012-WTL	12	DC	160	9.6	13.2		x
▶ R2N-2012-23-1024-WT	24	DC	640	19.2	26.4	x	
▶ R2N-2012-23-1024-WTL	24	DC	640	19.2	26.4		x
R2N-2012-23-1110-WT	110	DC	13600	88.0	121.0	x	
R2N-2012-23-1110-WTL	110	DC	13600	88.0	121.0		x
R2N-2012-23-5024-WT	24	AC 50/60Hz	158.0	19.2	26.4	x	
▶ R2N-2012-23-5024-WTL	24	AC 50/60Hz	158.0	19.2	26.4		x
▶ R2N-2012-23-5120-WT	120	AC 50/60Hz	3770	96.0	132.0	x	
▶ R2N-2012-23-5120-WTL	120	AC 50/60Hz	3770	96.0	132.0		x
R2N-2012-23-5230-WT	230	AC 50/60Hz	16100	184.0	253.0	x	
▶ R2N-2012-23-5230-WTL	230	AC 50/60Hz	16100	184.0	253.0		x

R3 DPDT AC 50/60Hz & DC coil

Part Number	Coil Voltage (V)	Coil Type	Coil resistance at 20 °C in Ω	Coil operating range		Options*	
				min. (at 20°C)	max. (at 55°C)	WT	WTL
R3N-2013-23-1012-WT	12	DC	160	9.6	13.2	x	
▶ R3N-2013-23-1012-WTL	12	DC	160	9.6	13.2		x
R3N-2013-23-1024-WT	24	DC	640	19.2	26.4	x	
▶ R3N-2013-23-1024-WTL	24	DC	640	19.2	26.4		x
R3N-2013-23-1110-WT	110	DC	13600	88.0	121.0	x	
R3N-2013-23-1110-WTL	110	DC	13600	88.0	121.0		x
R3N-2013-23-5024-WT	24	AC 50/60Hz	158.0	19.2	26.4	x	
R3N-2013-23-5024-WTL	24	AC 50/60Hz	158.0	19.2	26.4		x
▶ R3N-2013-23-5120-WT	120	AC 50/60Hz	3770	96.0	132.0	x	
▶ R3N-2013-23-5120-WTL	120	AC 50/60Hz	3770	96.0	132.0		x
R3N-2013-23-5230-WT	230	AC 50/60Hz	16100	184.0	253.0	x	
R3N-2013-23-5230-WTL	230	AC 50/60Hz	16100	184.0	253.0		x

R4 DPDT AC 50/60Hz & DC coil

Part Number	Coil Voltage (V)	Coil Type	Coil resistance at 20 °C in Ω	Coil operating range		Options*	
				min. (at 20°C)	max. (at 55°C)	WT	WTL
R4N-2014-23-1012-WT	12	DC	160	9.6	13.2	x	
▶ R4N-2014-23-1012-WTL	12	DC	160	9.6	13.2		x
▶ R4N-2014-23-1024-WT	24	DC	640	19.2	26.4	x	
▶ R4N-2014-23-1024-WTL	24	DC	640	19.2	26.4		x
R4N-2014-23-1110-WT	110	DC	13600	88.0	121.0	x	
▶ R4N-2014-23-1110-WTL	110	DC	13600	88.0	121.0		x
R4N-2014-23-5024-WT	24	AC 50/60Hz	158.0	19.2	26.4	x	
▶ R4N-2014-23-5024-WTL	24	AC 50/60Hz	158.0	19.2	26.4		x
▶ R4N-2014-23-5120-WT	120	AC 50/60Hz	3770	96.0	132.0	x	
▶ R4N-2014-23-5120-WTL	120	AC 50/60Hz	3770	96.0	132.0		x
R4N-2014-23-5230-WT	230	AC 50/60Hz	16100	184.0	253.0	x	
▶ R4N-2014-23-5230-WTL	230	AC 50/60Hz	16100	184.0	253.0		x

WT = with mechanical indicator + lockable front test button

WTL = with mechanical indicator + lockable front test button + light indicator (LED)

* other options available upon request

▶ BOLD - Regular stocked items.

R2, R3, R4

Industrial Electromagnetic Relays - Plug-in Sockets and Accessories



GZT2 (for R2)

Screw terminals
 Max. tightening moment for the terminal: 0.7 Nm
 35 mm rail mount acc. to PN-EN 60715
 or on panel mounting
 76,3 x 27 x 42.5(80) mm*
 Two poles
 12 A, 300 V AC



GZT2



GZT4-0040



G4 1052**



ZGGZ4 (see page 111)



GZT4-0035



Module type M... (see page 113)

CONNECTION DIAGRAM



DIMENSIONS



GZM2 (for R2)

Screw terminals
 Max. tightening moment for the terminal: 0.7 Nm
 35 mm rail mount acc. to PN-EN 60715
 or on panel mounting
 75 x 27 x 61(82) mm*
 Two poles
 12 A, 300 V AC



GZM2



GZT4-0040



G4 1052**



ZGGZ4 (see page 111)



GZT4-0035



Module type M... (see page 113)

CONNECTION DIAGRAM



DIMENSIONS



GZT3 (for R3)

Screw terminals
 Max. tightening moment for the terminal: 0.7 Nm
 35 mm rail mount acc. to PN-EN 60715
 or on panel mounting
 76,3 x 27 x 42.5(80) mm*
 Three poles
 10 A, 300 V AC



GZT3



GZT4-0040



G4 1052**



ZGGZ4 (see page 111)



GZT4-0035



Module type M... (see page 113)

CONNECTION DIAGRAM



DIMENSIONS

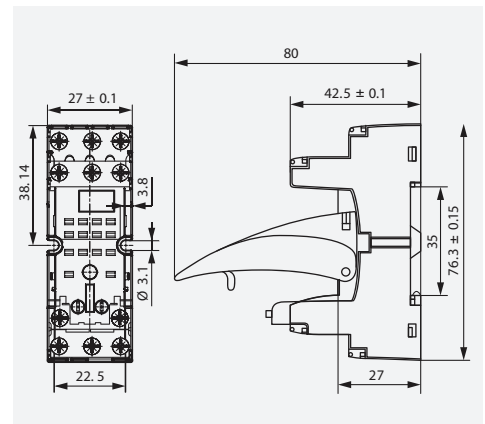

* In parenthesis is the height of the socket with plastic retainer clip. ** For lower profile application.

All accessories are sold separately.

R2, R3, R4

Industrial Electromagnetic Relays - Plug-in Sockets and Accessories

GZM3 (for R3)

Screw terminals
 Max. tightening moment
 for the terminal: 0.7 Nm
 35 mm rail mount
 acc. to PN-EN 60715
 or on panel mounting
 75 x 27 x 61(82) mm*
 Three poles
 10 A, 300 V AC



E22891



GZT2



GZT4-0040



G4 1052**



ZGGZ4 (see page 111)



GZT4-0035



Module type M... (see page 113)

CONNECTION DIAGRAM



DIMENSIONS

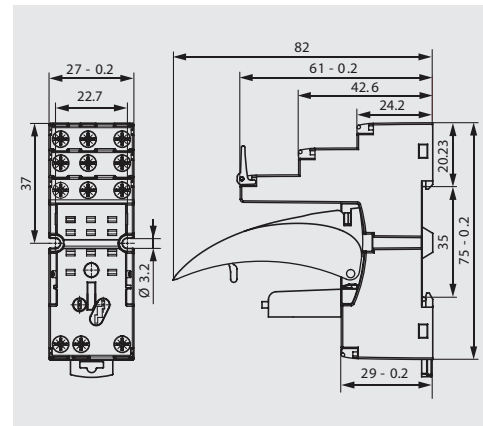

GZT4 (for R4)

Screw terminals
 Max. tightening moment
 for the terminal: 0.7 Nm
 35 mm rail mount
 acc. to PN-EN 60715
 or on panel mounting
 76,3 x 27 x 42.5(80) mm *
 Four poles
 6 A, 300 V AC



E22891



GZM2



GZT4-0040



G4 1052**



ZGGZ4 (see page 111)



GZT4-0035



Module type M... (see page 113)

CONNECTION DIAGRAM



DIMENSIONS



GZM4 (for R4)

Screw terminals
 Max. tightening moment
 for the terminal: 0.7 Nm
 35 mm rail mount
 acc. to PN-EN 60715
 or on panel mounting
 75 x 27 x 61(82) mm*
 Four poles
 6 A, 300 V AC



E22891



GZT3



GZT4-0040



G4 1052**



ZGGZ4 (see page 111)



GZT4-0035



Module type M... (see page 113)

CONNECTION DIAGRAM

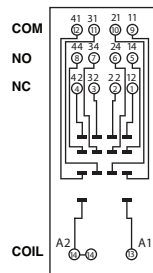

DIMENSIONS



* In parenthesis is the height of the socket with plastic retainer clip. ** For lower profile application.

All accessories are sold separately.

R2, R3, R4

Industrial Electromagnetic Relays - Plug-in Sockets and Accessories **Altech**[®]

GZMB2 (for R2)

Spring terminals

Max. cross section of the cables:

1 x 0,2...1,5 mm²

(1 x 24...16 AWG)

Stripping length deinsulation: 9...11 mm

35 mm rail mount

acc. to PN-EN 60715

95 x 31 x 42.5(80) mm*

Two poles

10 A, 300 V AC



E22891



GZMB2

CONNECTION DIAGRAM



DIMENSIONS



GZMB4-0040



G4 1052**



TR



Module type M... (see page 113)

GZMB4 (for R4)

Spring terminals

Max. cross section of the cables:

1 x 0,2...1,5 mm²

(1 x 24...16 AWG)

Stripping length deinsulation:

9...11 mm

35 mm rail mount

acc. to PN-EN 60715

95 x 31 x 42.5(80) mm*

Four poles

10 A, 300 V AC



E22891



GZMB4

CONNECTION DIAGRAM



DIMENSIONS



GZMB4-0040



G4 1052**



TR



Module type M... (see page 113)

* In parenthesis is the height of the socket with plastic retainer clip. ** For lower profile application.

All accessories are sold separately.

Компания «Океан Электроники» предлагает заключение долгосрочных отношений при поставках импортных электронных компонентов на взаимовыгодных условиях!

Наши преимущества:

- Поставка оригинальных импортных электронных компонентов напрямую с производств Америки, Европы и Азии, а так же с крупнейших складов мира;
- Широкая линейка поставок активных и пассивных импортных электронных компонентов (более 30 млн. наименований);
- Поставка сложных, дефицитных, либо снятых с производства позиций;
- Оперативные сроки поставки под заказ (от 5 рабочих дней);
- Экспресс доставка в любую точку России;
- Помощь Конструкторского Отдела и консультации квалифицированных инженеров;
- Техническая поддержка проекта, помощь в подборе аналогов, поставка прототипов;
- Поставка электронных компонентов под контролем ВП;
- Система менеджмента качества сертифицирована по Международному стандарту ISO 9001;
- При необходимости вся продукция военного и аэрокосмического назначения проходит испытания и сертификацию в лаборатории (по согласованию с заказчиком);
- Поставка специализированных компонентов военного и аэрокосмического уровня качества (Xilinx, Altera, Analog Devices, Intersil, Interpoint, Microsemi, Actel, Aeroflex, Peregrine, VPT, Syfer, Eurofarad, Texas Instruments, MS Kennedy, Miteq, Cobham, E2V, MA-COM, Hittite, Mini-Circuits, General Dynamics и др.);

Компания «Океан Электроники» является официальным дистрибьютором и эксклюзивным представителем в России одного из крупнейших производителей разъемов военного и аэрокосмического назначения «**JONHON**», а так же официальным дистрибьютором и эксклюзивным представителем в России производителя высокотехнологичных и надежных решений для передачи СВЧ сигналов «**FORSTAR**».



JONHON

«**JONHON**» (основан в 1970 г.)

Разъемы специального, военного и аэрокосмического назначения:

(Применяются в военной, авиационной, аэрокосмической, морской, железнодорожной, горно- и нефтедобывающей отраслях промышленности)

«**FORSTAR**» (основан в 1998 г.)

ВЧ соединители, коаксиальные кабели, кабельные сборки и микроволновые компоненты:

(Применяются в телекоммуникациях гражданского и специального назначения, в средствах связи, РЛС, а так же военной, авиационной и аэрокосмической отраслях промышленности).



Телефон: 8 (812) 309-75-97 (многоканальный)

Факс: 8 (812) 320-03-32

Электронная почта: ocean@oceanchips.ru

Web: <http://oceanchips.ru/>

Адрес: 198099, г. Санкт-Петербург, ул. Калинина, д. 2, корп. 4, лит. А