

Asper 2.4G / GNSS Antenna

Part No. SRFWG018

flexiiANT[®]

Product Specification

1. Features

- Dual Antenna for 1559 – 1609 MHz and 2.4 – 2.5 GHz applications
- Wi-Fi,[®] Bluetooth, GNSS.
- Maintains high performance with good isolation within device: DFI (Designed For Integration)
- 1.13mm diameter RF cable with IPEX MHF connector
- Self-Adhesive mounted
- Quick integration minimizes design cycle
- High performance
- Available in 3 standard cable lengths

2. Description

Asper is a dual antenna that combines two separate antenna systems within a single flexible form factor. Intended for use with Wi-Fi, Bluetooth with positioning applications. Simple integration with plug and play simplicity. This product specification shows the performance of the antenna to cover a typical BT / Wi-Fi and GNSS bands: 2.4-2.5GHz / 1559-1609MHz.

3. Applications

- Sport cameras
- Trackers
- Dash cams
- Portable Devices
- Network Devices
- Wearable devices
- MIMO Systems

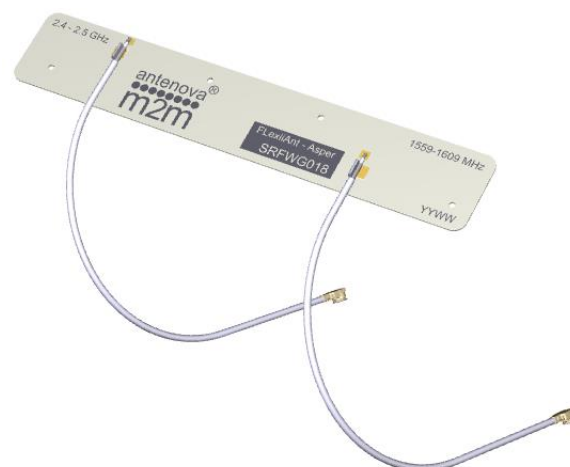

4. Part Number

Asper: SRFWG018-xxx



Note. -xxx refers to cable length option:

Part Number	Cable Length
SRFWG018-100	100mm
SRFWG018-150	150mm
SRFWG018-200	200mm

5. General Data

Product name	Asper
Part Number	SRFWG018
Frequency	1559 – 1609 MHz; 2.4-2.5GHz
Polarization	Linear
Operating temperature	-40°C to +85°C
Impedance with matching	50 Ω
Weight	< 0.5 g
Antenna Assembly type	FPC Self-adhesive 3M 468MP
Dimensions (Antenna)	81.0 x 14.0 x 0.15 (mm)
Cable length	100 /150 / 200
Connection	MHF IPEX

6. RF Characteristics

	1559 – 1609 MHz	2.4 – 2.5 GHz	Conditions
Peak gain	4.25dBi	5.6dBi	All data measured in a loaded condition adhered to a plastic carrier free space.
Average gain	-1.1dBi	-0.6dBi	
Average efficiency	>75%	>85%	
Maximum return loss	-18.4dB	-14.5dB	
Maximum VSWR	1.3:1	1.4:1	

7. RF Performance 1559-1609MHz

7.1 Return Loss

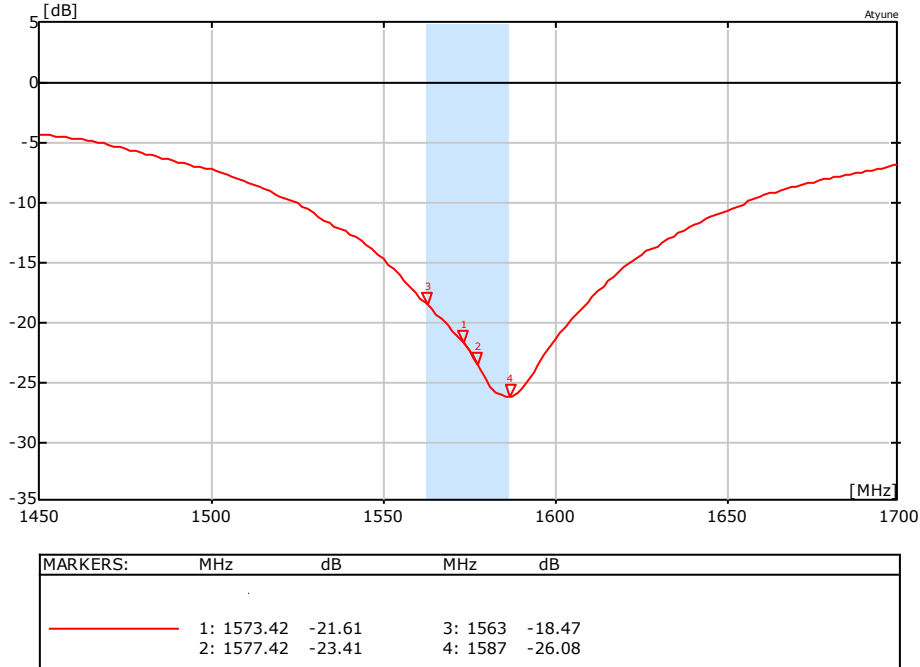

7.2 VSWR

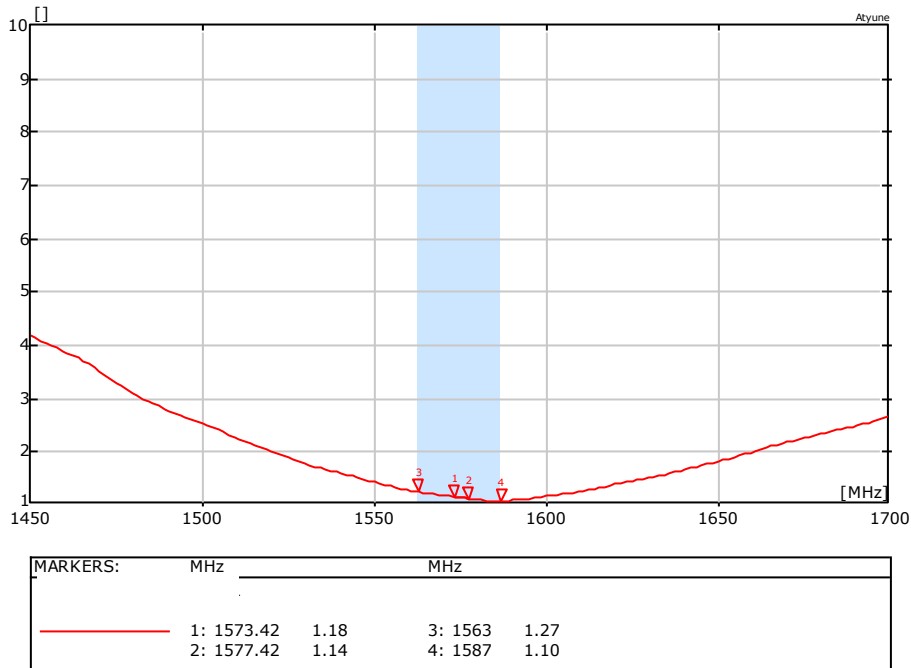

7.3 Antenna patterns GNSS

7.3.1 1559 MHz – 1609 MHz



3D pattern at 1575 MHz
*Drag to rotate pattern and PCB by using Adobe Reader
(Click to Activate)*

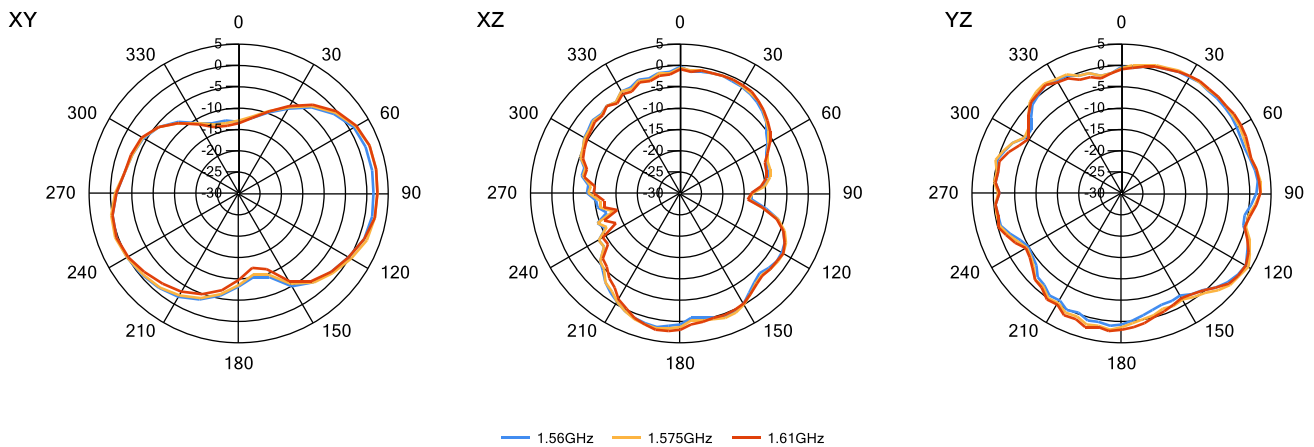

7. RF Performance 2.4-2.5GHz

7.1 Return Loss

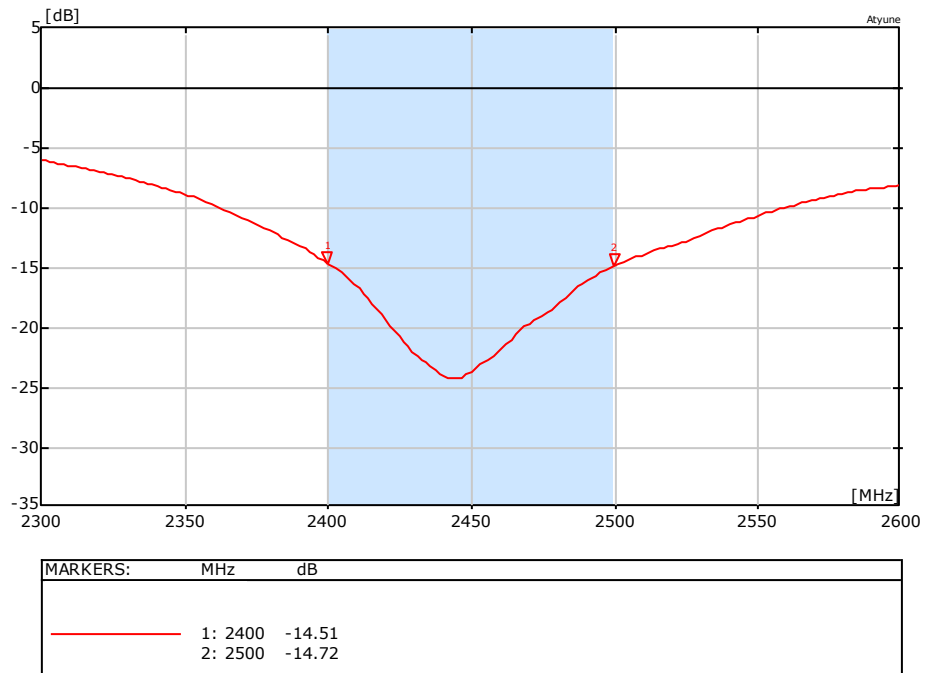

7.2 VSWR

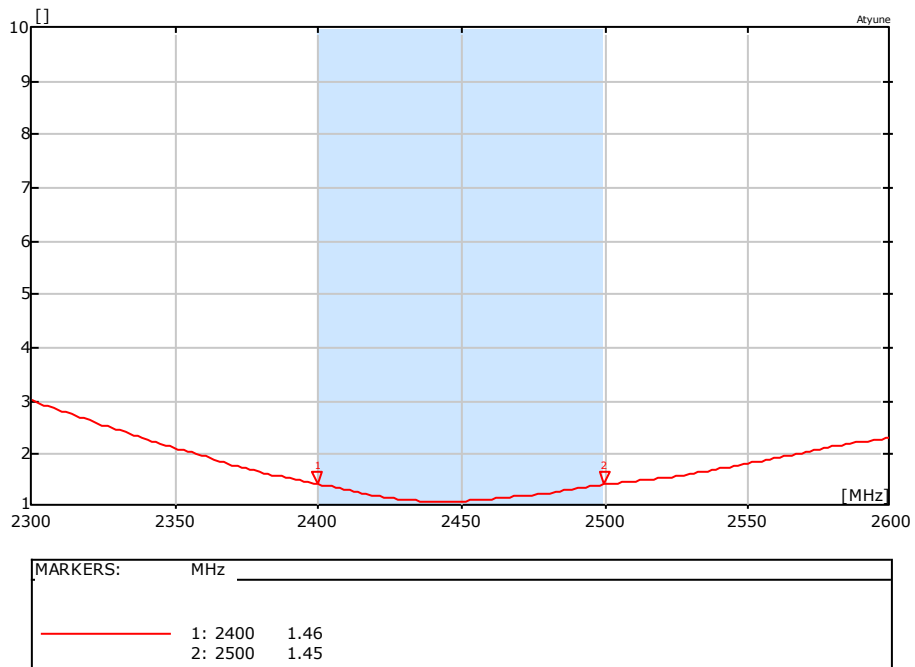

7.3 Antenna patterns

7.3.1 2400 MHz – 2500 MHz

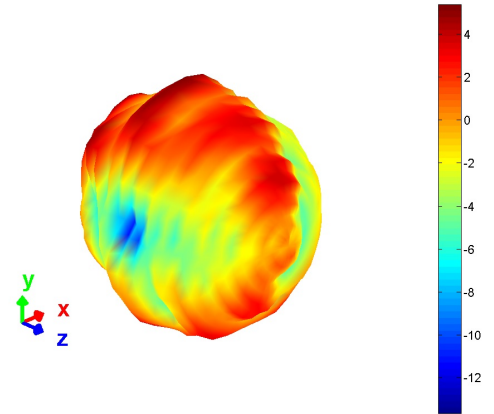

3D pattern at 2.45GHz
*Drag to rotate pattern and PCB by using Adobe Reader
(Click to Activate)*

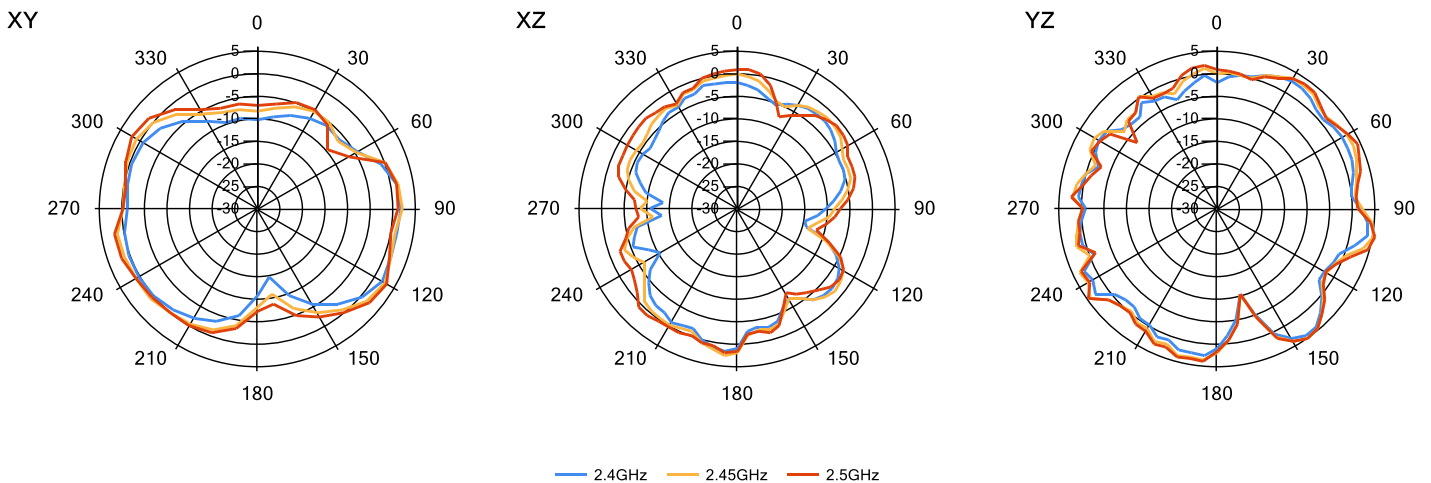

7.4 Isolation

The antennas isolation to each other is shown here tested free space. The isolation is <-17dB.

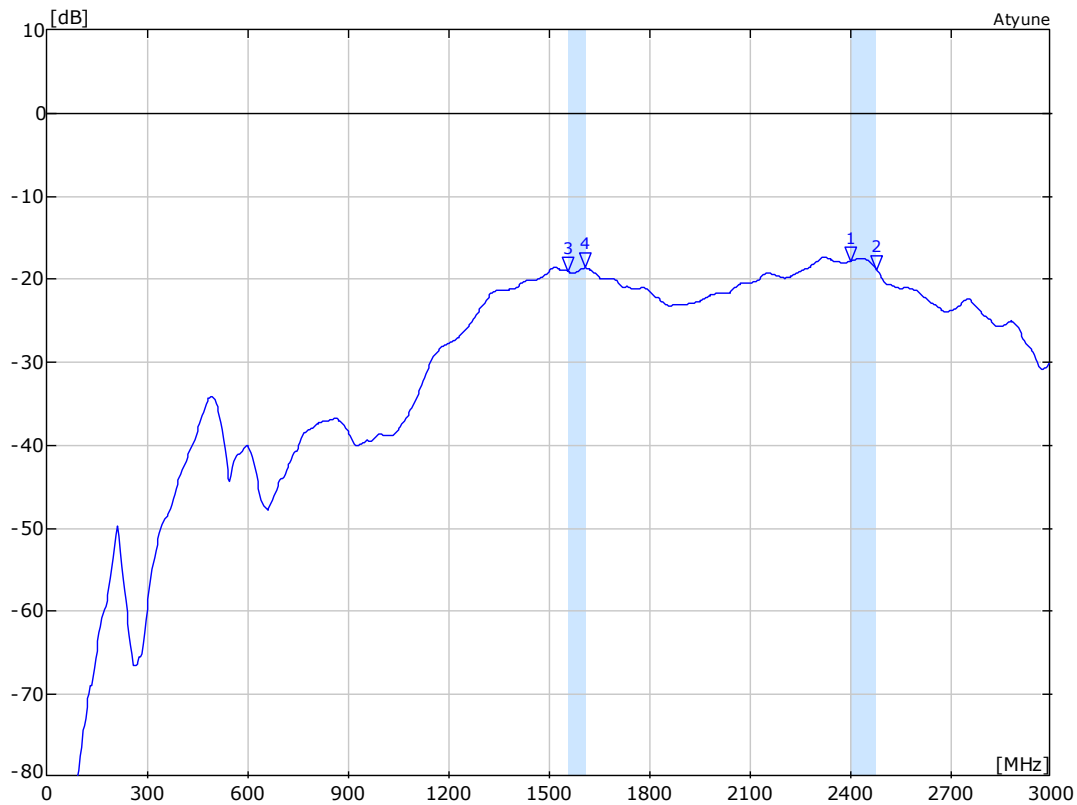

MARKERS:	MHz	dB	MHz	dB
Isolation.s1p - S11				
—	1: 2402	-17.73	3: 1559	-19.03
	2: 2480	-18.82	4: 1609	-18.54

8. Antenna Dimensions

8.1 Dimensions FPC section

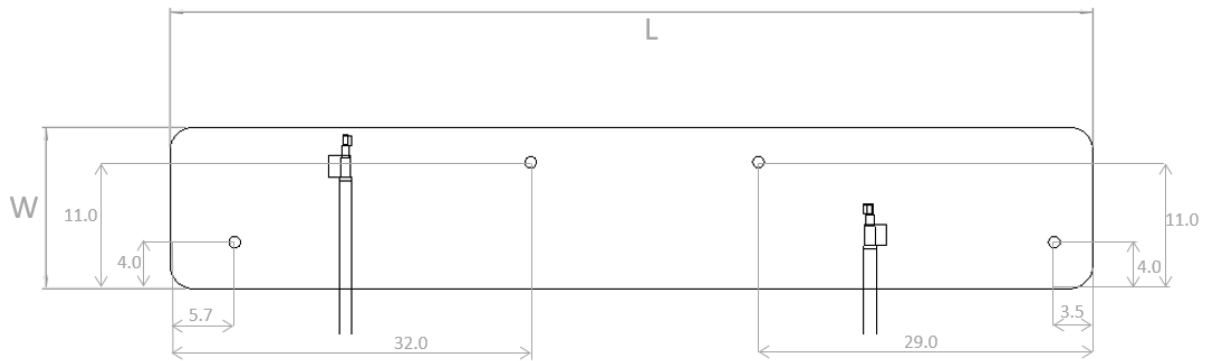

4 Holes = 1mm \varnothing (diameter)

L	W	T
Length	Width	Thickness
81.0 \pm 0.2 (mm)	14.0 \pm 0.2 (mm)	0.15 (mm) nominal

All dimensions in mm

8.2 Dimensions assembled

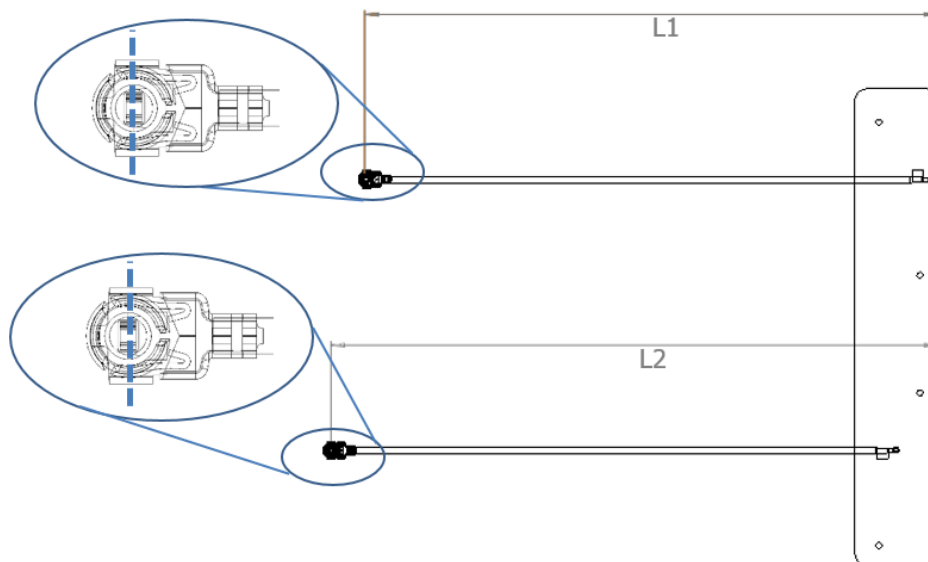

SRFWG018-100	SRFWG018-150	SRFWG018-200
L1 (Wi-Fi)	L1 (Wi-Fi)	L1 (Wi-Fi)
101 \pm 2.0 (mm)	151 \pm 2.0 (mm)	201 \pm 2.0 (mm)
L2 (GNSS)	L2 (GNSS)	L2 (GNSS)
107 \pm 2.0 (mm)	157 \pm 2.0 (mm)	207 \pm 2.0 (mm)

Antennas for Wireless M2M Applications

8.3 IPEX Connector

I-PEX	
Material	Copper Alloy
Plating	Ag

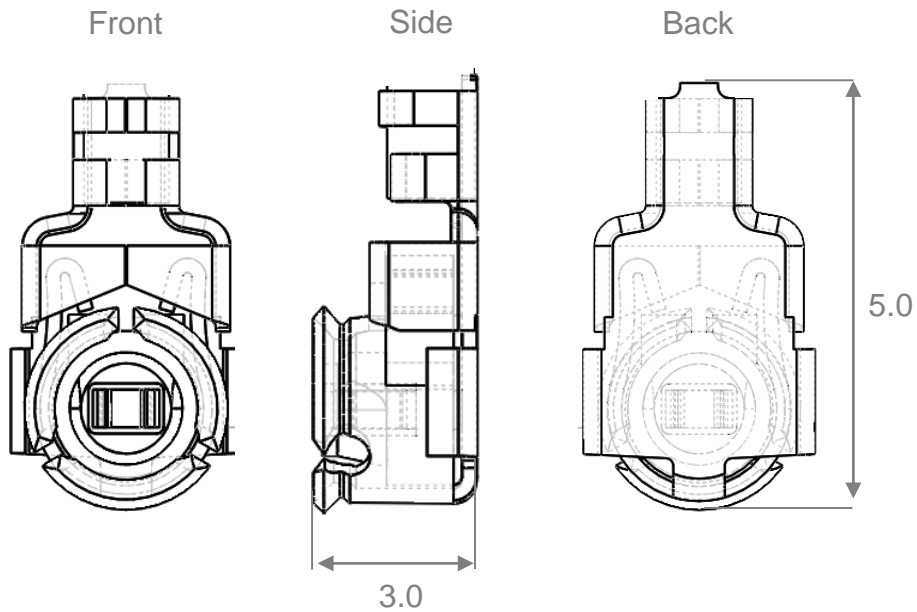

All dimensions in mm

8.4 Assembly

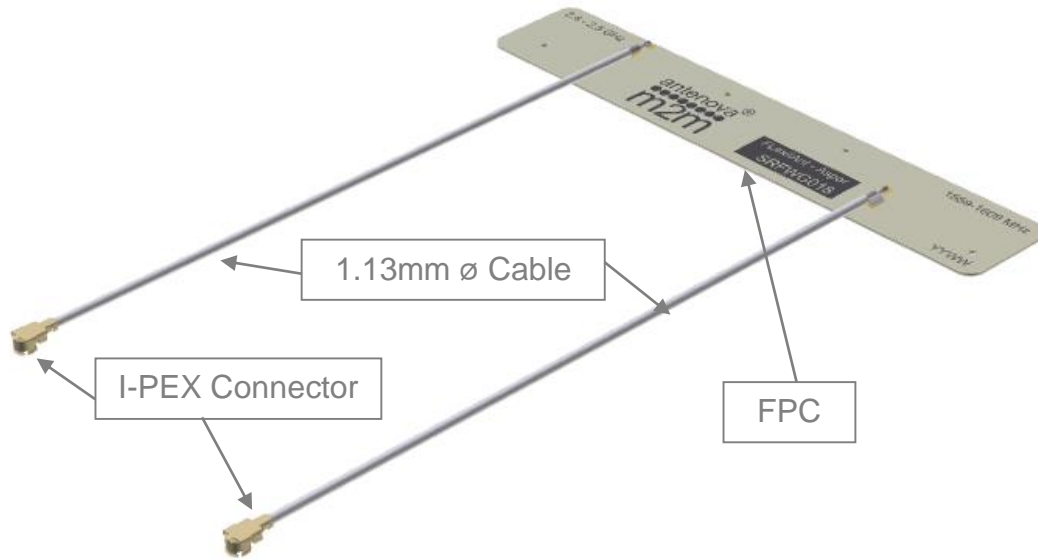

8.5 Antenna zones

The antenna contains two separate radiating structures, they are defined by the frequency band marked on the FPC and correspond to that side.

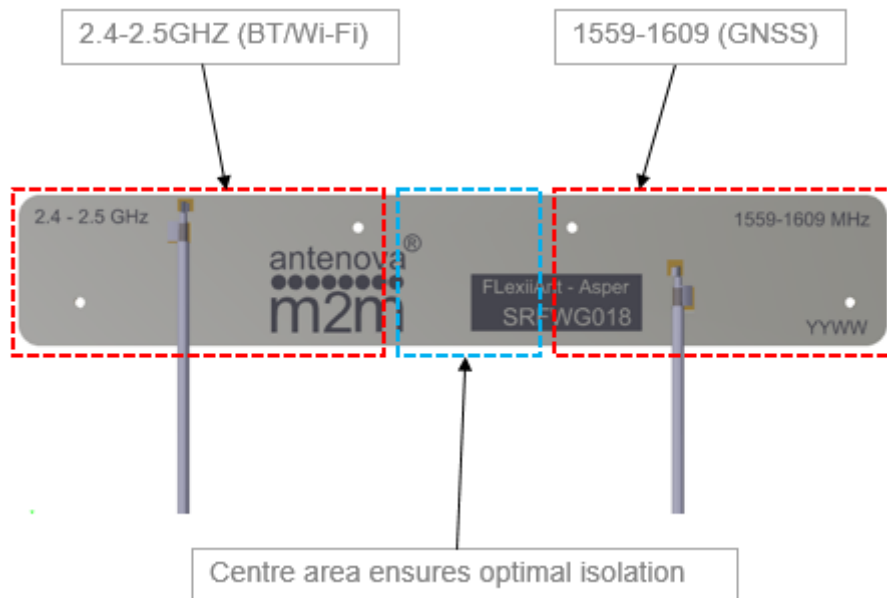

9. Electrical Interface

9.1 Host Interface

The host PCB requires the mating connector which is IPEX MHF (UFL) receptacle. The location should be close to the chip/modules pin for the RF. Any feed from this receptacle should be maintained at 50Ω impedance.

9.2 Transmission Line

All transmission lines should be designed to have a characteristic impedance of 50Ω.

- The length of the transmission lines should be kept to a minimum
- Any other parts of the RF system like transceivers, power amplifiers, etc, should also be designed to have an impedance of 50 Ω

Once the material for the PCB has been chosen (PCB thickness and dielectric constant), a coplanar transmission line can easily be designed using any of the commercial software packages for transmission line design. For the chosen PCB thickness, copper thickness and substrate dielectric constant, the program will calculate the appropriate transmission line width and gaps on either side of the feed.

A DC blocking capacitor should be placed in line to protect the RF front end.

9.3 Mechanical Fixing

The antenna uses 3M 468MP adhesive on the reverse side of the FPC. The antenna has an easy access split line to peel off to reveal the adhesive side. It is designed for a one time fix to a clean smooth surface.

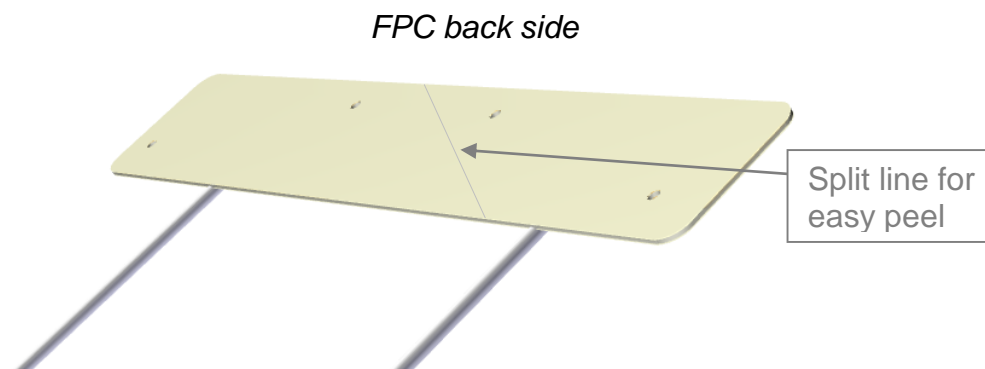

10.0 Antenna Integration Guide

10.1 Placement

For placing the FPC antenna within a device, the host PCB size is not a factor like PCB mounted antennas. However placement still needs to follow some basic rules, as any antenna is sensitive to its environment.

Using six spatial directions shown below as a guide. The antenna FPC section should try to maintain a minimum of three directions free from obstructions to be able to operate effectively. The other directions will have obstacles in its path, these directions still require a minimum clearance. These minimum clearances are further defined in this section. The plastic case is not included in this, only metal objects/components that will obstruct or come in close proximity to the antenna.

Six spatial directions relative to FPC

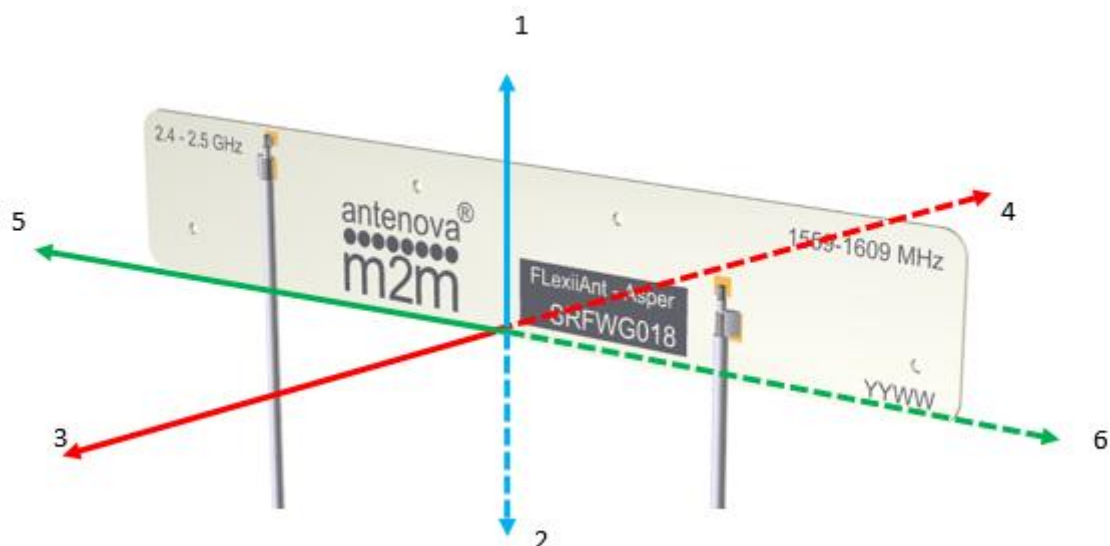

10.2 Orientation of FPC

The orientation of the FPC with respect to the host PCB should be defined depending on the unit. The proximity of the GND will have an influence on the antenna so the PCB location relative to the antenna should be considered.

The FPC will normally be placed in one of the three following options for orientation. In each option a distance (d) is the critical dimension to consider. Below shows the minimum value of (d) for each. Other obstructions may increase this dimension.

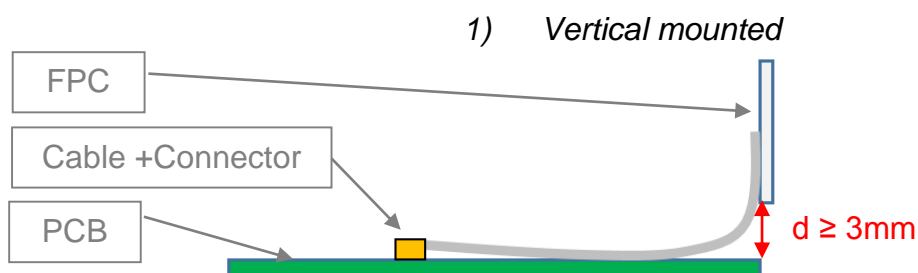

1) *Co-planar to PCB*



2) *Planar to PCB (Same plane)*



10.3 Device Integration example

An example of the placement within a device is shown below using a sports camera. The device contains the major components along with the device outer case. The FPC is shown adhered to the inside of the device's plastic housing. The length of the cable is sufficient to allow ease of assembly when produced (SRFWG018-100).

The FPC was placed in two planes to utilise the available space. The antenna is adhered to the inside both vertically and horizontally. The GNSS section is horizontal for the best orientation, while the BT/Wi-Fi is vertically placed.

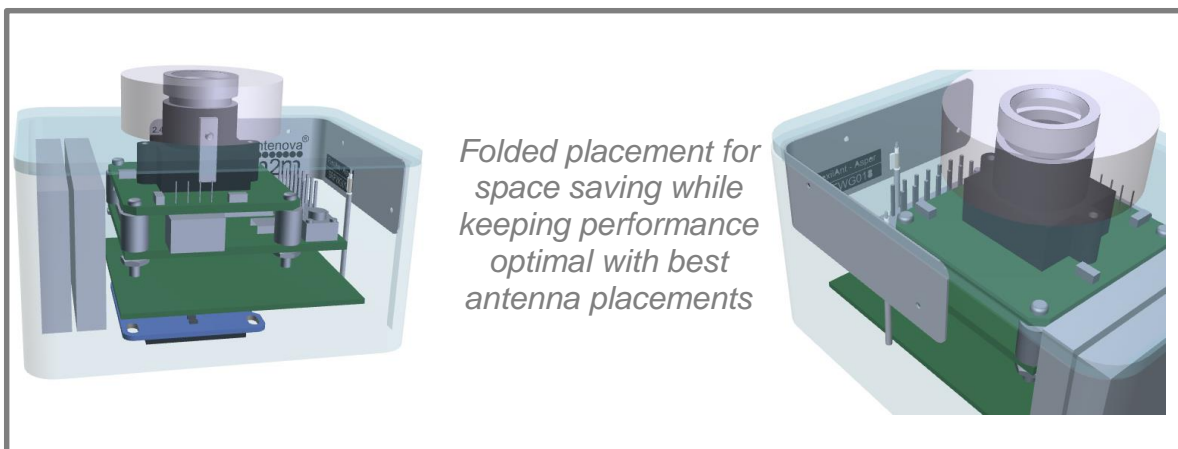
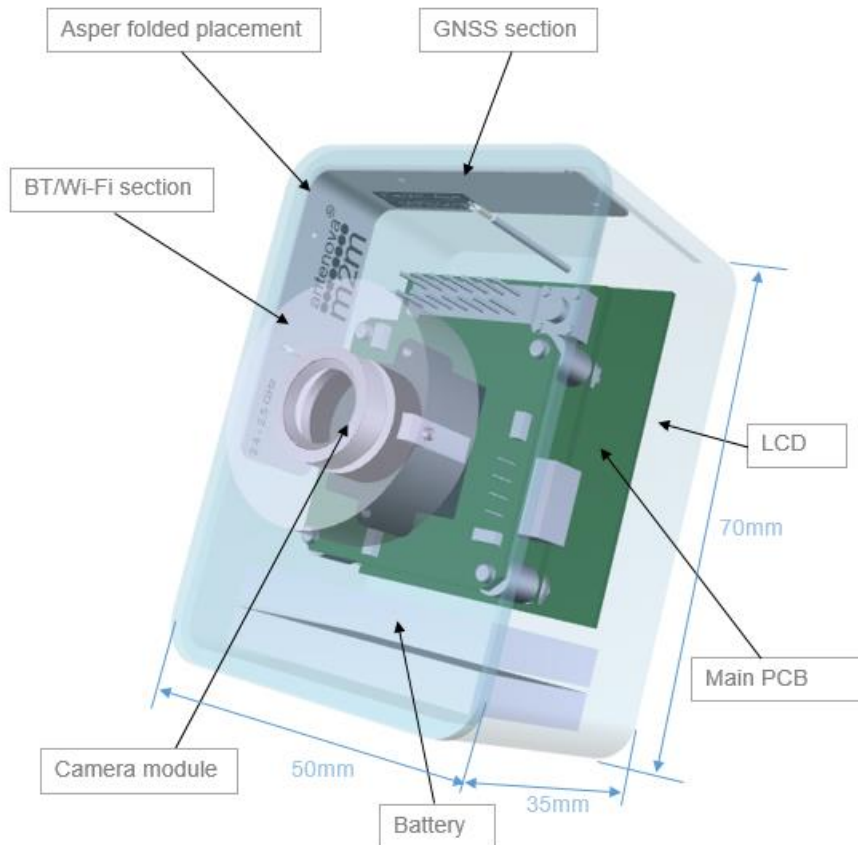

11. Hazardous Material Regulation Conformance

The antenna has been tested to conform to RoHS requirements. A certificate of conformance is available from Antenova M2M's website.

12. Packaging

The antennas are stored in individual plastic (PE) bags. Then stored within a second bag of 10pcs.

Single antenna per bag

10 units per second bag (Labelled)

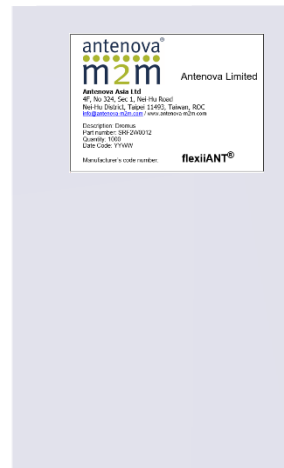

12.1 Optimal Storage Conditions

Temperature	-10°C to 40°C
Humidity	Less than 75% RH
Shelf life	18 Months
Storage place	Away from corrosive gas and direct sunlight
Packaging	Antennas should be stored in unopened sealed manufacturer's plastic packaging.

12.2 Label Information

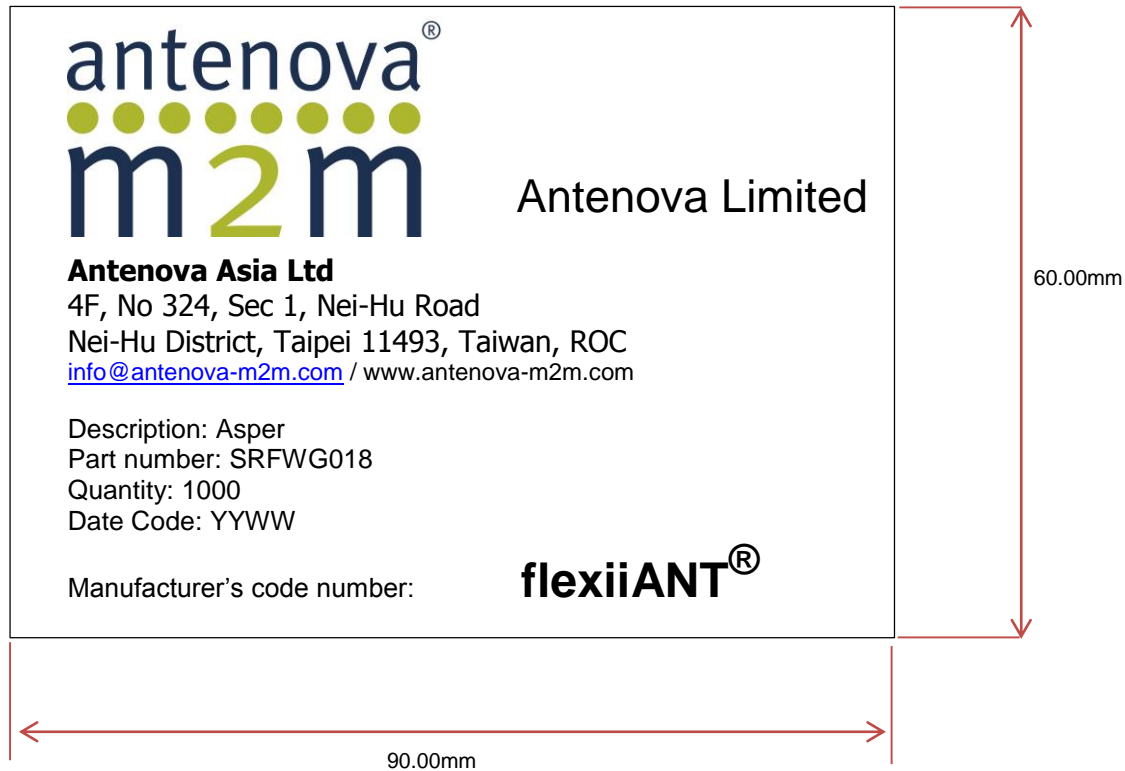



www.antenova-m2m.com

Corporate Headquarters

Antenova Limited
2nd Floor Titan Court
Bishop Square
Hatfield
AL10 9NA
UK

Tel: +44 1233 810600

Email: sales@antenova-m2m.com

North America Headquarters

Antenova Limited
100 Brush Creek Road, Suite 103
Santa Rosa
California 95404
USA

Tel: +1 707 890 5202

Email: sales@antenova-m2m.com

Asia Headquarters

Antenova Asia Limited
4F, No. 324, Sec. 1, Nei-Hu Road
Nei-Hu District
Taipei 11493
Taiwan, ROC

Tel: +886 (0) 2 8797 8630

Fax: +886 (0) 2 8797 6890

Email: sales@antenova-m2m.com

Copyright® Antenova Ltd. All Rights Reserved. Antenova®, Antenova M2M®, gigaNOVA® the Antenova product family names, and the Antenova and Antenova M2M logos are trademarks and/or registered trademarks of Antenova Ltd. Any other names and/or trademarks belong to their respective companies.

The materials provided herein are believed to be reliable and correct at the time of printing. Antenova does not warrant the accuracy or completeness of the information, text, graphics or other items contained within this information. Antenova further assumes no responsibility for the use of this information, and all such information shall be entirely at the user's risk.



Certificate No: 4598

Antennas for Wireless M2M Applications

Компания «Океан Электроники» предлагает заключение долгосрочных отношений при поставках импортных электронных компонентов на взаимовыгодных условиях!

Наши преимущества:

- Поставка оригинальных импортных электронных компонентов напрямую с производств Америки, Европы и Азии, а так же с крупнейших складов мира;
- Широкая линейка поставок активных и пассивных импортных электронных компонентов (более 30 млн. наименований);
- Поставка сложных, дефицитных, либо снятых с производства позиций;
- Оперативные сроки поставки под заказ (от 5 рабочих дней);
- Экспресс доставка в любую точку России;
- Помощь Конструкторского Отдела и консультации квалифицированных инженеров;
- Техническая поддержка проекта, помощь в подборе аналогов, поставка прототипов;
- Поставка электронных компонентов под контролем ВП;
- Система менеджмента качества сертифицирована по Международному стандарту ISO 9001;
- При необходимости вся продукция военного и аэрокосмического назначения проходит испытания и сертификацию в лаборатории (по согласованию с заказчиком);
- Поставка специализированных компонентов военного и аэрокосмического уровня качества (Xilinx, Altera, Analog Devices, Intersil, Interpoint, Microsemi, Actel, Aeroflex, Peregrine, VPT, Syfer, Eurofarad, Texas Instruments, MS Kennedy, Miteq, Cobham, E2V, MA-COM, Hittite, Mini-Circuits, General Dynamics и др.);

Компания «Океан Электроники» является официальным дистрибьютором и эксклюзивным представителем в России одного из крупнейших производителей разъемов военного и аэрокосмического назначения «JONHON», а так же официальным дистрибьютором и эксклюзивным представителем в России производителя высокотехнологичных и надежных решений для передачи СВЧ сигналов «FORSTAR».



JONHON

«JONHON» (основан в 1970 г.)

Разъемы специального, военного и аэрокосмического назначения:

(Применяются в военной, авиационной, аэрокосмической, морской, железнодорожной, горно- и нефтедобывающей отраслях промышленности)

«FORSTAR» (основан в 1998 г.)

ВЧ соединители, коаксиальные кабели,
кабельные сборки и микроволновые компоненты:

(Применяются в телекоммуникациях гражданского и специального назначения, в средствах связи, РЛС, а так же военной, авиационной и аэрокосмической отраслях промышленности).



Телефон: 8 (812) 309-75-97 (многоканальный)

Факс: 8 (812) 320-03-32

Электронная почта: ocean@oceanchips.ru

Web: <http://oceanchips.ru/>

Адрес: 198099, г. Санкт-Петербург, ул. Калинина, д. 2, корп. 4, лит. А