

## Features

- Fuses at 120 V or 240 V
- E24 resistance values
- RoHS compliant\*
-  UL Listed

## Applications

- White goods
- Inverters
- Lighting
- Metering

# FWxxA Series Fusible Power Resistors

### General Introduction

The FWxxA Series of axial leaded wirewound resistors is designed to fuse under abnormal conditions such as sudden surges in voltage or circuit malfunctions. The resistor will fuse upon application of 120 or 240 voltages.

### Electrical Characteristics

Characteristic	FW Series
Power	1, 2, 3, 5, 7** W
Resistance Range	4.7 ohms to 100 ohms (E24 values)
UL Listed Resistance Range	4.7 ohms to 47 ohms
Tolerance	5 %
Temperature Coefficient	±200 PPM/°C
Operating Temperature Range	-55 °C to +155 °C
Maximum Voltage	$\sqrt{P \cdot R}$
Fusing Point	See Fusing Performance Chart
Fusing Time	See Fusing Performance Chart

The resistor will fuse safely if 120 or 240 V is applied. The time to fuse depends on the resistance value.

\*\* 7 W = 240 Vac only.

### Product Dimensions

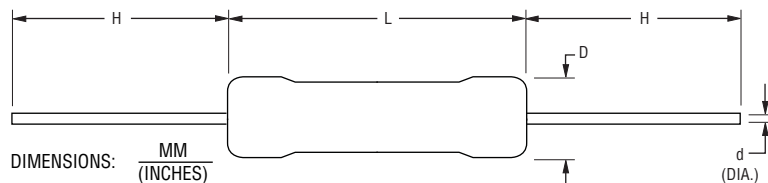

Model	Dimensions			
	D (Max.)	L (Max.)	H	d
FW10A (1 W)	$\frac{5.5}{(.217)}$	$\frac{12}{(.472)}$	$\frac{28 \pm 3.0}{(1.102 \pm .118)}$	$\frac{0.55 \pm 0.05}{(.022 \pm .002)}$
FW20A (2 W)	$\frac{6.0}{(.236)}$	$\frac{12}{(.472)}$	$\frac{28 \pm 3.0}{(1.102 \pm .118)}$	$\frac{0.65 \pm 0.05}{(.026 \pm .002)}$
FW30A (3 W)	$\frac{6.5}{(.256)}$	$\frac{16}{(.630)}$	$\frac{28 \pm 3.0}{(1.102 \pm .118)}$	$\frac{0.75 \pm 0.05}{(.030 \pm .002)}$
FW50A (5 W)	$\frac{7.5}{(.295)}$	$\frac{18}{(.709)}$	$\frac{28 \pm 3.0}{(1.102 \pm .118)}$	$\frac{0.75 \pm 0.05}{(.030 \pm .002)}$
FW70A (7 W)	$\frac{9.5}{(.374)}$	$\frac{26}{(1.024)}$	$\frac{38 \pm 3.0}{(1.496 \pm .118)}$	$\frac{0.75 \pm 0.05}{(.030 \pm .002)}$

### Agency Listing

Description	
UL	File Number: E349323

### Materials

Resistor ..... Wire wound around a ceramic core  
 Lead Wire ..... Tinned copper  
 Housing ..... Insulated resin

### How to Order

**FW 10 A 7R50 J A**

Model \_\_\_\_\_  
 FW = Fusible Wirewound

Rated Power \_\_\_\_\_  
 10 = 1.0 Watts  
 20 = 2.0 Watts  
 30 = 3.0 Watts  
 50 = 5.0 Watts  
 70 = 7.0 Watts

Pin Style \_\_\_\_\_  
 A = Axial

Resistance Code \_\_\_\_\_  
 •  $R < 100$  ohms:  
 "R" represents decimal point (examples: 7R50 = 7.5 ohms)  
 •  $R \geq 100$  ohms:  
 First three digits are significant, fourth digit represents number of zeros to follow (example: 1000 = 100 ohms)

Resistance Tolerance \_\_\_\_\_  
 J = ±5 %

Packaging \_\_\_\_\_  
 A = Ammo Pack  
 • 1,000 pcs./box: FW10, FW20, FW30  
 • 500 pcs./box: FW50, FW70

### Popular Values

Resistance Value (Ohms)	Resistance Code
4.7	4R70
5.1	5R10
5.6	5R60
6.2	6R20
6.8	6R80
7.5	7R50
8.2	8R20
9.1	9R10
10	10R0

\*RoHS Directive 2002/95/EC Jan. 27, 2003 including annex and RoHS Recast 2011/65/EU June 8, 2011.

Specifications are subject to change without notice.

The device characteristics and parameters in this data sheet can and do vary in different applications and actual device performance may vary over time.

Users should verify actual device performance in their specific applications.

# FWxxA Series Fusible Power Resistors

# BOURNS®

## Performance Specifications

Characteristic	Limits	Test Method (JIS-C-5201 & JIS-C-5202)
Temperature Coefficient	±200 PPM/°C max.	<b>4.8</b> Natural resistance changes per temperature (°C):  $\frac{R_2 - R_1}{R_1(T_2 - T_1)} \times 10^6 \text{ (PPM/°C)}$ R1: Resistance value at room temp. (T1) R2: Resistance value at room temp. +100 °C (T2)
Short Time Overload	Resistance change rate is ±5 % max., with no evidence of mechanical damage.	<b>4.13</b> Permanent resistance change after the application of a potential of 2.5 times RCWV for 5 seconds.
Terminal Strength	No evidence of mechanical damage.	<b>4.16 Direct Load:</b> Resistance to a 2.5 kg direct load for 10 seconds in the direction of the longitudinal axis of the terminal leads.  <b>Twist Test:</b> Terminal leads shall be bent through 90 ° at a point of approximately 6 mm from the body of the resistor and shall be rotated through 360 ° (about the original axis of the bent terminal) in alternating directions for a total of three rotations.
Resistance to Soldering Heat	Resistance change rate is ±1 % max., with no evidence of mechanical damage.	<b>4.18</b> Permanent resistance change when leads are immersed to a point 2.0 to 2.5 mm from the body in 260 °C (±5 °C) solder for 10 (±1) seconds.
Solderability	95 % coverage minimum	<b>4.17</b> The area covered with a new, smooth, clean, shiny and continuous surface free from concentrated pinholes.  Test temp. of solder: 245 °C (±3 °C). Dwell time in solder: 2~3 seconds.
Load Life in Humidity	Resistance change rate is ±5 % max., with no evidence of mechanical damage.	<b>7.9</b> Resistance change after 1,000 hours (1.5 hours "ON", 0.5 hours "OFF") at RCWV in a humidity test chamber controlled at 40 °C (±2 °C) and 90-95 % relative humidity.
Safety Fuse	Resistance value shall increase at least 100 times initial value.	1 W ~ 5 W: Load 120/240 VAC voltage. 7 W: Load 240 VAC voltage. Resistor must be safely fused.
Dielectric Withstanding Voltage	No evidence of flashover mechanical damage, arcing or insulation breakdown.	<b>UL1412,</b> <b>19.1</b> A resistor (or a resistor and its mounting if provided), shall withstand, without breakdown, for a period of not less than one minute, a 60 Hz potential of 1000 V plus twice the rated voltage applied between live parts and dead metal parts, if any.

## Typical Part Marking

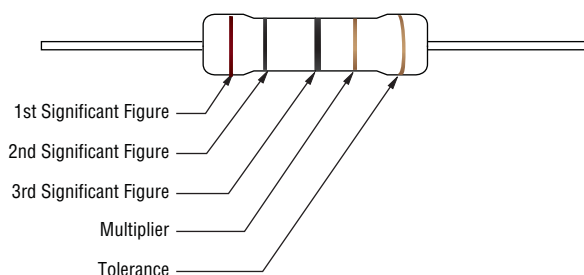

Color	1st Band	2nd Band	3rd Band	Multiplier	Tolerance
Black	0	0	0	1 Ω	
Brown	1	1	1	10 Ω	±1 %
Red	2	2	2	100 Ω	±2 %
Orange	3	3	3	1 KΩ	
Yellow	4	4	4	10 KΩ	
Green	5	5	5	100 KΩ	±0.5 %
Blue	6	6	6	1 MΩ	±0.25 %
Violet	7	7	7	10 MΩ	±0.10 %
Grey	8	8	8		±0.05 %
White	9	9	9		
Gold				0.1 Ω	±5 %
Silver				0.01 Ω	±10 %

Specifications are subject to change without notice.  
 The device characteristics and parameters in this data sheet can and do vary in different applications and actual device performance may vary over time.  
 Users should verify actual device performance in their specific applications.

# FWxxA Series Fusible Power Resistors



## Pulse Performance

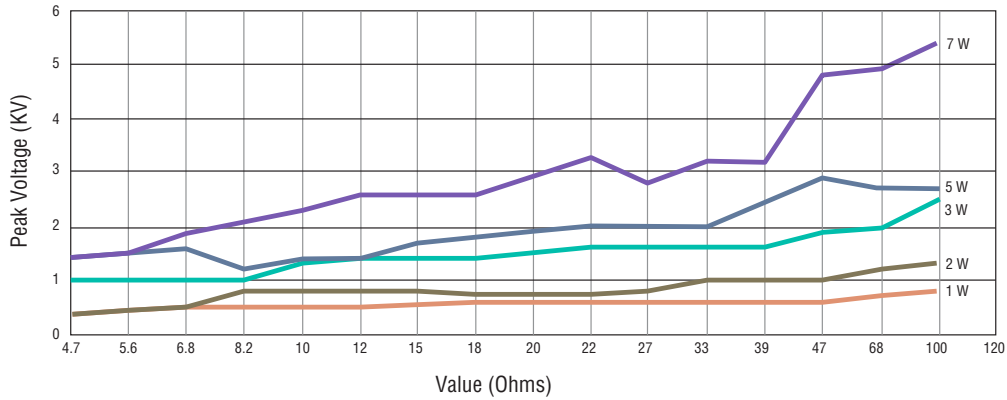

1.2/50  $\mu$ s Peak Voltage Limit (10 pulses at 10 sec. intervals,  $\Delta R < 5\%$ )

NOTE: The voltage shown in these curves is the voltage across the resistor. The generator voltage will be higher due to the generator's internal impedance.

## Fusing Performance

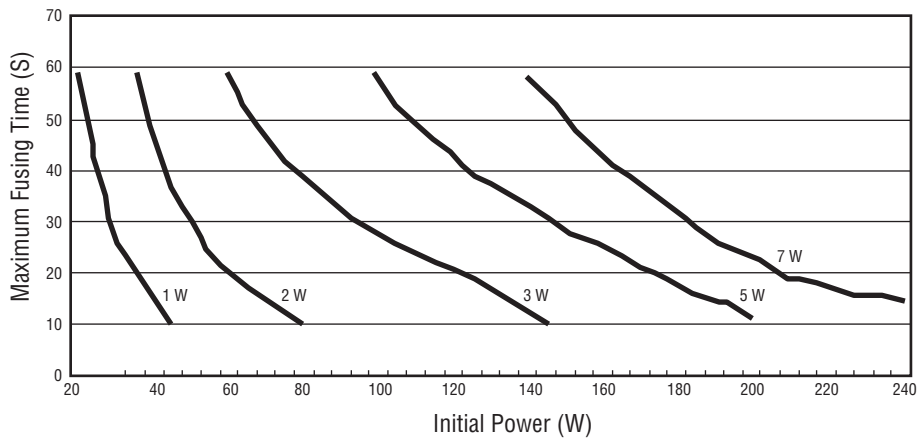

## Temperature Rise

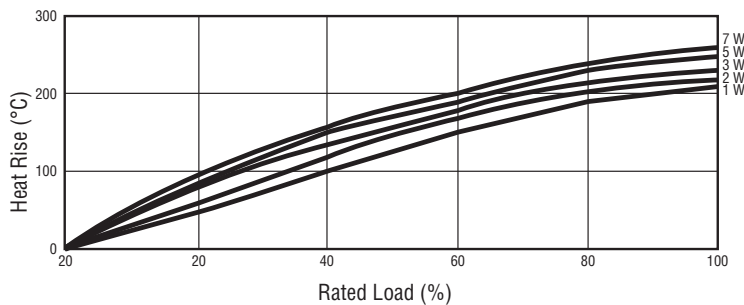

## Power Derating Curve

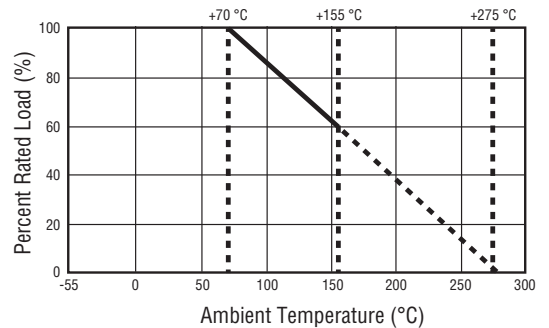

Specifications are subject to change without notice.

The device characteristics and parameters in this data sheet can and do vary in different applications and actual device performance may vary over time. Users should verify actual device performance in their specific applications.

# FWxxA Series Fusible Power Resistors

**BOURNS®**

## Packaging Specifications

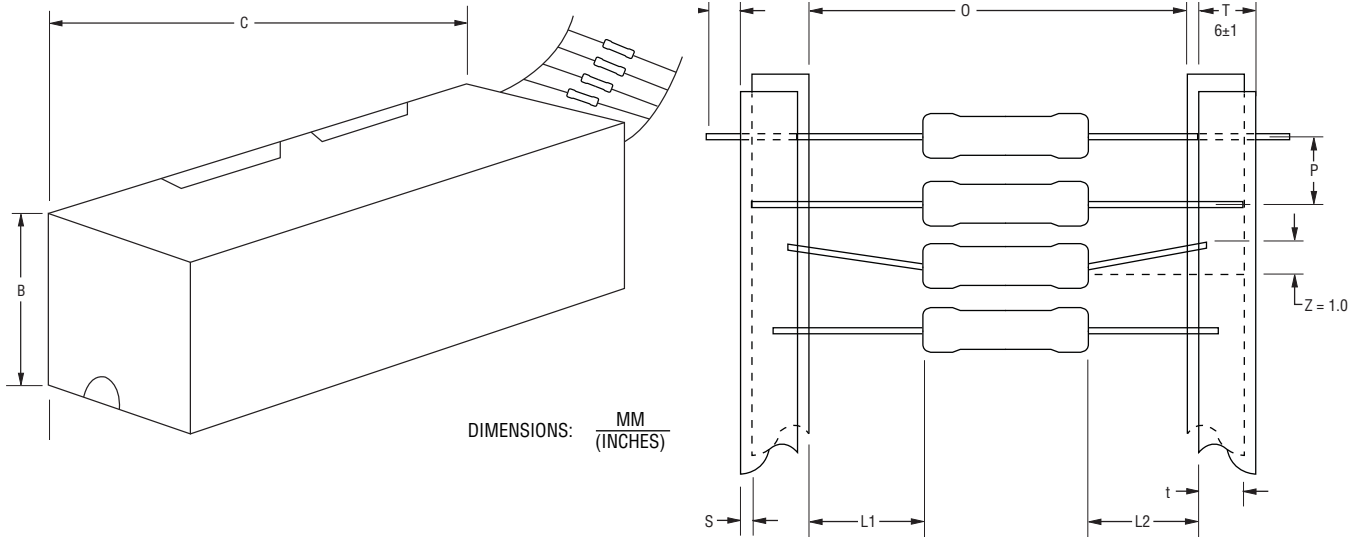

Model	O	P	A	B	C	Qty./Box
FW10A (1 W)	$\frac{58 \pm 1}{(2.283 \pm .039)}$	$\frac{5 \pm 0.3}{(.197 \pm .112)}$	$\frac{75 \pm 5}{(2.953 \pm .197)}$	$\frac{70 \pm 5}{(2.756 \pm .197)}$	$\frac{255 \pm 5}{(10.039 \pm .197)}$	1,000 pcs.
FW20A (2 W)	$\frac{58 \pm 1}{(2.283 \pm .039)}$	$\frac{5 \pm 0.3}{(.197 \pm .112)}$	$\frac{80 \pm 5}{(3.150 \pm .197)}$	$\frac{82 \pm 5}{(3.228 \pm .197)}$	$\frac{255 \pm 5}{(10.039 \pm .197)}$	1,000 pcs.
FW30A (3 W)	$\frac{65 \pm 1}{(2.559 \pm .039)}$	$\frac{10 \pm 0.3}{(.393 \pm .112)}$	$\frac{90 \pm 5}{(3.543 \pm .197)}$	$\frac{119 \pm 5}{(4.685 \pm .197)}$	$\frac{255 \pm 5}{(10.039 \pm .197)}$	1,000 pcs.
FW50A (5 W)	$\frac{65 \pm 1}{(2.559 \pm .039)}$	$\frac{10 \pm 0.3}{(.393 \pm .112)}$	$\frac{90 \pm 5}{(3.543 \pm .197)}$	$\frac{88 \pm 5}{(3.465 \pm .197)}$	$\frac{255 \pm 5}{(10.039 \pm .197)}$	500 pcs.
FW70A (7 W)	$\frac{65 \pm 1}{(2.559 \pm .039)}$	$\frac{10 \pm 0.3}{(.393 \pm .112)}$	$\frac{90 \pm 5}{(3.543 \pm .197)}$	$\frac{88 \pm 5}{(3.465 \pm .197)}$	$\frac{255 \pm 5}{(10.039 \pm .197)}$	500 pcs.

**BOURNS®**

**Asia-Pacific:** Tel: +886-2 2562-4117 • Fax: +886-2 2562-4116

**Europe:** Tel: +41-41 768 5555 • Fax: +41-41 768 5510

**The Americas:** Tel: +1-951 781-5500 • Fax: +1-951 781-5700

[www.bourns.com](http://www.bourns.com)

Компания «Океан Электроники» предлагает заключение долгосрочных отношений при поставках импортных электронных компонентов на взаимовыгодных условиях!

Наши преимущества:

- Поставка оригинальных импортных электронных компонентов напрямую с производств Америки, Европы и Азии, а так же с крупнейших складов мира;
- Широкая линейка поставок активных и пассивных импортных электронных компонентов (более 30 млн. наименований);
- Поставка сложных, дефицитных, либо снятых с производства позиций;
- Оперативные сроки поставки под заказ (от 5 рабочих дней);
- Экспресс доставка в любую точку России;
- Помощь Конструкторского Отдела и консультации квалифицированных инженеров;
- Техническая поддержка проекта, помощь в подборе аналогов, поставка прототипов;
- Поставка электронных компонентов под контролем ВП;
- Система менеджмента качества сертифицирована по Международному стандарту ISO 9001;
- При необходимости вся продукция военного и аэрокосмического назначения проходит испытания и сертификацию в лаборатории (по согласованию с заказчиком);
- Поставка специализированных компонентов военного и аэрокосмического уровня качества (Xilinx, Altera, Analog Devices, Intersil, Interpoint, Microsemi, Actel, Aeroflex, Peregrine, VPT, Syfer, Eurofarad, Texas Instruments, MS Kennedy, Miteq, Cobham, E2V, MA-COM, Hittite, Mini-Circuits, General Dynamics и др.);

Компания «Океан Электроники» является официальным дистрибьютором и эксклюзивным представителем в России одного из крупнейших производителей разъемов военного и аэрокосмического назначения «JONHON», а так же официальным дистрибьютором и эксклюзивным представителем в России производителя высокотехнологичных и надежных решений для передачи СВЧ сигналов «FORSTAR».



## JONHON

«JONHON» (основан в 1970 г.)

Разъемы специального, военного и аэрокосмического назначения:

(Применяются в военной, авиационной, аэрокосмической, морской, железнодорожной, горно- и нефтедобывающей отраслях промышленности)

«FORSTAR» (основан в 1998 г.)

ВЧ соединители, коаксиальные кабели, кабельные сборки и микроволновые компоненты:

(Применяются в телекоммуникациях гражданского и специального назначения, в средствах связи, РЛС, а так же военной, авиационной и аэрокосмической отраслях промышленности).



Телефон: 8 (812) 309-75-97 (многоканальный)

Факс: 8 (812) 320-03-32

Электронная почта: [ocean@oceanchips.ru](mailto:ocean@oceanchips.ru)

Web: <http://oceanchips.ru/>

Адрес: 198099, г. Санкт-Петербург, ул. Калинина, д. 2, корп. 4, лит. А