PWM/ VFM Step-up DC/DC Converter for White LED Applications

NO.EA-327-160106

OUTLINE

The R1214Z is a low supply current PWM/ VFM step-up DC/DC converter. Internally, the device consists of an Nch MOSFET driver, an oscillator, a PWM comparator, a voltage reference unit, an error amplifier, an overcurrent protection circuit, an under voltage lockout circuit (UVLO), an overvoltage protection circuit (LxOVP, LEDOVP), a thermal shutdown protection circuit and 2-channel current drivers for white LEDs.

The R1214Z requires minimal external component count. By simply using an inductor, a resistor, capacitors and a diode, the white LEDs can be driven with constant current and high efficiency. The LED current can be determined by the value of current setting resistor. The brightness of the LEDs can be adjusted quickly by applying a 200 Hz to 300 kHz PWM signal to the PWM pin.

The R1214Z provides the PWM control or the PWM/VFM auto switching control. The PWM control switches at fixed frequency rate in low output current in order to reduce noise. Likewise, the PWM/VFM auto switching control automatically switches from PWM mode to VFM mode in low output current in order to achieve high efficiency. RICOH's unique control method can suppress a ripple voltage in the VFM mode, thus the R1214Z can achieve both low ripple voltage at light load and high efficiency.

The R1214Z provides an overcurrent protection circuit to limit the Lx peak current, an UVLO circuit to prevent the malfunction of the device at low input voltage, a LxOVP circuit to monitor the excess Lx voltage, a LEDOVP circuit to monitor the excess LED1-2 voltage and a thermal shutdown protection circuit to detect the overheating of the device and stops the operation to protect the device from damage.

The R1214Z is offered in a 9-pin WLCSP-9-P1 package.

FEATURES

- Input Voltage Range (Maximum Rating) 2.7 V to 5.5 V (6.5 V)
- Supply Current Typ. 500 μ A
- Standby Current..... Typ. 0.2 μ A, Max. 5 μ A
- Overcurrent Protection Circuit Typ. 1.9 A
- Overvoltage Protection (OVP) Circuit..... Typ. 35 V
- LED1-2 Current Matching Circuit Max. 0.5% (R1214Zxx1C/ D, 20 mA)
Max. 1.0% (R1214Zxx1A/ B, 20 mA)
- Oscillator Frequency Typ. 750 kHz/ 450 kHz
- Maximum Duty Cycle Typ. 96% (R1214Zx11x)
Typ. 94% (R1214Zx21x)
- Nch ON Resistance Typ. 0.25 Ω ($V_{IN} = 3.6$ V)
- Undervoltage Lockout (UVLO) Circuit Typ. 2.4 V
- Thermal Shutdown Circuit Typ. 150°C
- LED Dimming Control..... By sending a 200 Hz to 300 kHz PWM signal to the PWM pin
- Package..... WLCSP-9-P1

R1214Z

NO.EA-327-160106

APPLICATION

- White LED backlight driver for LCD displays for portable equipment
- White LED backlight driver for LCD displays for Smartphones, Tablets and Note PCs

SELECTION GUIDE

The combinations of oscillator frequency, LED voltage and power controlling method are user-selectable options.

Selection Guide

Product Name	Package	Quantity per Reel	Pb Free	Halogen Free
R1214Z2(y)1(z)-E2-F	WLCSP-9-P1	5,000 pcs	Yes	Yes

2(y)1(z)	(y): Oscillator Frequency	(z): LED Voltage (I _{LED} = 20 mA)	(z): Power Controlling Method
211A	450 kHz	320 mV	PWM/ VFM Auto Switching
221A	750 kHz		
211B	450 kHz	320 mV	PWM
211C	450 kHz	600 mV	PWM/ VFM Auto Switching
221C	750 kHz		
211D	450 kHz	600 mV	PWM

BLOCK DIAGRAMS

R1214Z Block Diagram

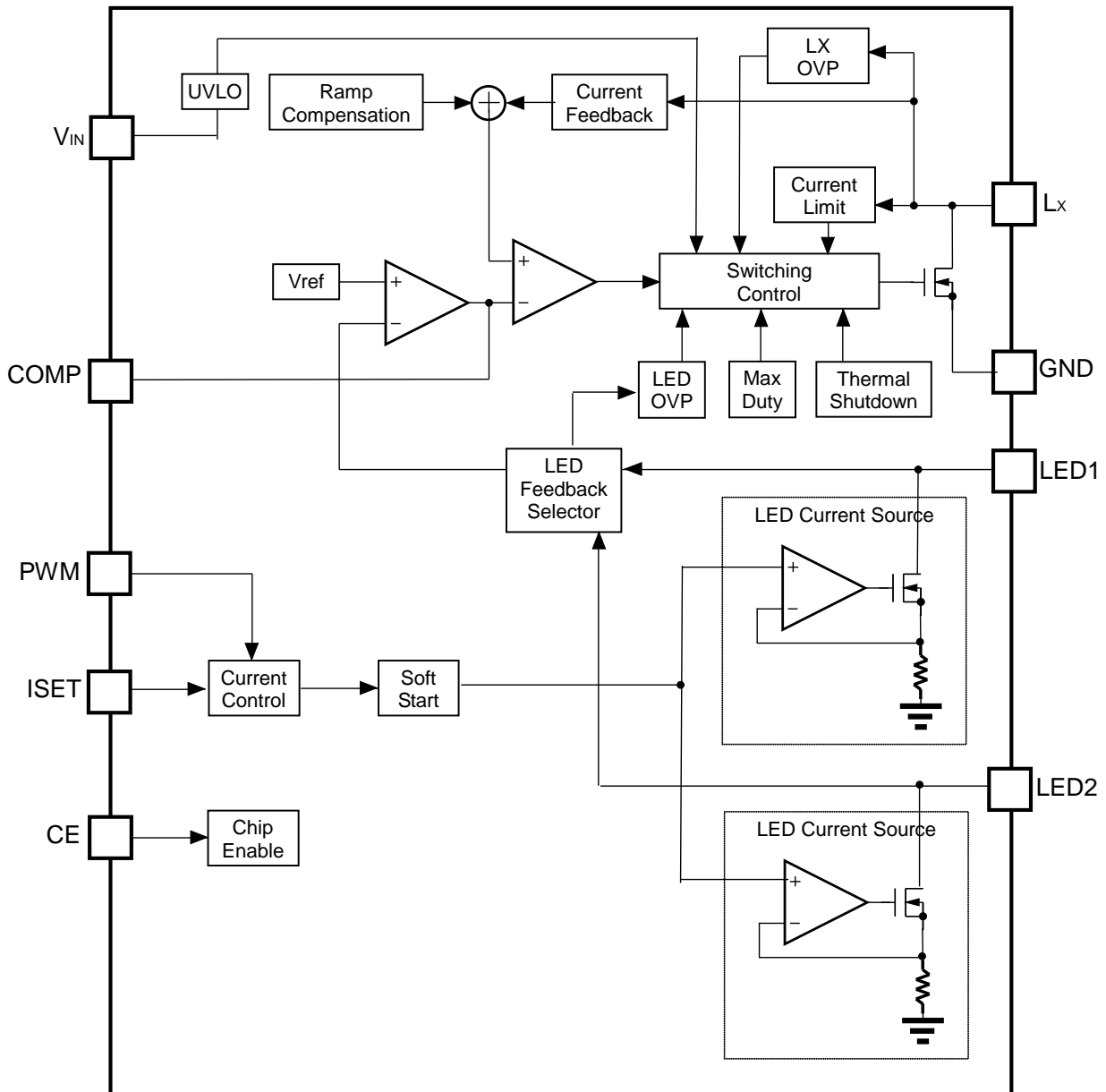

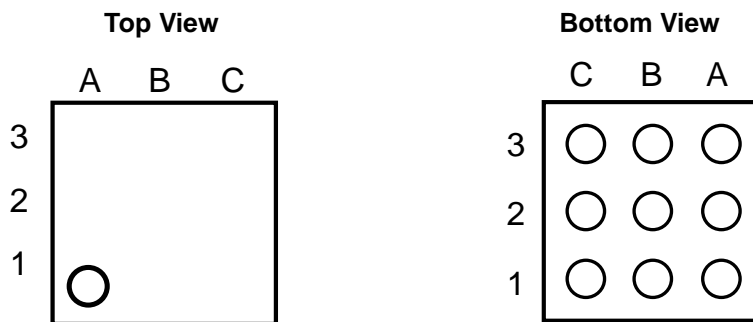
PIN DESCRIPTION**WLCSP-9-P1 Pin Configurations****WLCSP-9-P1 Pin Description**

Pin No.	Symbol	Description
A1	ISET	LED Current Control Pin
A2	LED1	LED Current Supply Pin 1
A3	LED2	LED Current Supply Pin 2
B1	PWM	PWM Dimming Control Input Pin
B2	COMP	Error Amplifier Output Pin
B3	GND	Ground Pin
C1	CE	Chip Enable Pin, Active-high
C2	V _{IN}	Analog Input Voltage Pin
C3	L _x	Switching Pin, Open Drain Output

ABSOLUTE MAXIMUM RATINGS

Absolute Maximum Ratings

(GND = 0 V)

Symbol	Item	Rating	Unit
V_{IN}	V_{IN} Pin Voltage	-0.3 to 6.5	V
V_{CE}	CE Pin Voltage	-0.3 to 6.5	V
V_{ISET}	ISET Pin Voltage	-0.3 to 6.5	V
V_{COMP}	COMP Pin Voltage	-0.3 to 6.5	V
V_{LX}	L_x Pin Voltage ⁽¹⁾	-0.3 to 41.5	V
V_{PWM}	PWM Pin Voltage	-0.3 to 6.5	V
V_{LED}	LED1, LED2 Pin Voltage	-0.3 to 6.5	V
P_D	Power Dissipation (High Wattage Land Pattern) ⁽²⁾	1190	mW
T_a	Operating Temperature Range	-40 to 85	°C
T_{stg}	Storage Temperature Range	-55 to 125	°C

ABSOLUTE MAXIMUM RATINGS

Electronic and mechanical stress momentarily exceeded absolute maximum ratings may cause the permanent damages and may degrade the life time and safety for both device and system using the device in the field. The functional operation at or over these absolute maximum ratings are not assured.

RECOMMENDED OPERATING CONDITONS

Symbol	Item	Rating	Unit
V_{IN}	Input Voltage	2.7 to 5.5	V
T_a	Operating Temperature Range	-40 to 85	°C

RECOMMENDED OPERATING CONDITIONS

All of electronic equipment should be designed that the mounted semiconductor devices operate within the recommended operating conditions. The semiconductor devices cannot operate normally over the recommended operating conditions, even if when they are used over such ratings by momentary electronic noise or surge. And the semiconductor devices may receive serious damage when they continue to operate over the recommended operating conditions.

⁽¹⁾ Constantly applying a constant-voltage higher than 6.5 V to the L_x pin from the outside may cause the permanent damages to the device.

⁽²⁾ Refer to *POWER DISSIPATION* for detailed information.

R1214Z

NO.EA-327-160106

ELECTRICAL CHARACTERISTICS

The specifications surrounded by are over $-40^{\circ}\text{C} \leq T_a \leq 85^{\circ}\text{C}$. and guaranteed by design engineering.

R1214Z Electrical Characteristics

($T_a = 25^{\circ}\text{C}$)

Symbol	Item	Conditions	Min.	Typ.	Max.	Unit	
I_{DD}	Supply Current	$V_{IN} = 3.6\text{ V}$, no load, non-switching		0.5		mA	
$I_{standby}$	Standby Current	$V_{IN} = 5.5\text{ V}$, $V_{CE} = 0\text{ V}$		0.2	5.0	μA	
V_{UVLO1}	UVLO Detector Threshold	V_{IN} falling	2.25	2.4		V	
V_{UVLO2}	UVLO Released Voltage	V_{IN} rising		$V_{UVLO1} + 0.1$	2.65	V	
V_{CEH}	CE Input Voltage "H"	$V_{IN} = 5.5\text{ V}$	1.5			V	
V_{CEL}	CE Input Voltage "L"	$V_{IN} = 2.7\text{ V}$			0.4	V	
R_{CE}	CE Pull-down Resistance	$V_{IN} = 5.5\text{ V}$		1200		K Ω	
R_{PWM}	PWM Pull-down Resistance	$V_{IN} = 5.5\text{ V}$		1200		K Ω	
I_{LED}	LED1-2 Current Accuracy	$R_{ISET} = 30.1\text{ k}\Omega$ (1 string = 20 mA) $V_{IN} = 3.6\text{ V}$	R1214Zxx1A/ B	19.6	20	20.4	mA
			R1214Zxx1C/ D	19.7	20	20.3	
I_{LEDM1}	LED1-2 Current Matching Accuracy 1 (1 string = 20 mA)	$R_{ISET} = 30.1\text{ k}\Omega$ PWMduty = 100% $V_{IN} = 3.6\text{ V}$ $(I_{MAX} - I_{Ave}^{(1)}) / I_{Ave}$	R1214Zxx1A/ B		0.2	1.0	%
				R1214Zxx1C/ D		0.1	
I_{LEDM2}	LED1-2 Current Matching Accuracy 2 (1 string = 20 mA)	$R_{ISET} = 30.1\text{ k}\Omega$ PWMduty = 10% ($f_{PWM} = 20\text{ kHz}$) $V_{IN} = 3.6\text{ V}$ $(I_{MAX} - I_{Ave}) / I_{Ave}$	R1214Zxx1A/ B		0.5		%
				R1214Zxx1C/ D		0.3	
I_{LEDMAX}	LED1-2 Maximum Current at 100% Dimming Range	$V_{IN} = 3.6\text{ V}$	40			mA	
$I_{LEDLEAK}$	LED1-2 Leakage Current	$V_{IN} = 5.5\text{ V}$, $V_{LED1-2} = 1\text{ V}$, $V_{CE} = 0\text{ V}$			3.0	μA	
R_{ON}	Nch ON Resistance	$V_{IN} = 3.6\text{ V}$, $I_{LX} = 100\text{ mA}$		0.25		Ω	
I_{LXLEAK}	Lx Leakage Current	$V_{IN} = 5.5\text{ V}$, $V_{LX} = 41\text{ V}$			3.0	μA	
I_{LXLIM}	Lx Current Limit	$V_{IN} = 3.6\text{ V}$	1.3	1.9	2.5	A	
V_{LED}	LED1-2 Regulated Voltage	R1214Zxx1A/ B (1 string = 20 mA), $V_{IN} = 3.6\text{ V}$		320		mV	
		R1214Zxx1C/ D (1 string = 20 mA), $V_{IN} = 3.6\text{ V}$		600			
fosc	Oscillator Frequency	R1214Zx11x, $V_{IN} = 3.6\text{ V}$	400	450	500	kHz	
		R1214Zx21x, $V_{IN} = 3.6\text{ V}$	675	750	825		

(1) I_{Ave} is the average current of LED1-2.

ELECTRICAL CHARACTERISTICS (continued)

The specifications surrounded by are over $-40^{\circ}\text{C} \leq T_a \leq 85^{\circ}\text{C}$. and guaranteed by design engineering.

R1214Z Electrical Characteristics

($T_a = 25^{\circ}\text{C}$)

Symbol	Item	Conditions	Min.	Typ.	Max.	Unit	
Maxduty	Maximum Duty Cycle	R1214Zx11x, $V_{IN} = 3.6\text{ V}$	92	96		%	
		R1214Zx21x, $V_{IN} = 3.6\text{ V}$	91	94			
V_{OVP1}	V_{LX} OVP Detector Threshold	V_{OUT} rising $V_{IN} = 3.6\text{ V}$	R1214Z2x1x	29	35	41	V
V_{OVP2}	V_{LED} OVP Detector Threshold	V_{LED1-2} rising, $V_{IN} = 3.6\text{ V}$		4.3	4.5	4.7	V
tstart	Soft Start Time	$V_{IN} = 3.6\text{ V}$		15		ms	
T_{TSD}	Thermal Shutdown Temperature	$V_{IN} = 3.6\text{ V}$		150		$^{\circ}\text{C}$	
T_{TSR}	Thermal Shutdown Release Temperature	$V_{IN} = 3.6\text{ V}$		125		$^{\circ}\text{C}$	

All test items listed under ELECTRICAL CHARACTERISTICS are done under the pulse load condition ($T_j \approx T_a = 25^{\circ}\text{C}$) except LED1-2 Current max at 100% Dimming Range.

THEORY OF OPERATION

Soft-Start

During start-up, soft-start increases the output voltage (V_{OUT}) by forcibly switching the L_x pin and gradually increasing the L_x current limit (I_{LxLIM}). If the preset LED current is 1.5 mA or more, soft-start gradually increases the LED current (I_{LED}) until it reaches the preset LED current. If the preset LED current is less than 1.5 mA, soft-start increases I_{LED} until it reaches 1.5 mA, then reduces it to the preset LED current. To minimize the overshoot of I_{LED} , a 1- μ F capacitor ($C4$) can be used.

Overcurrent Protection

If the peak inductor current (I_{Lmax}) exceeds I_{LxLIM} , overcurrent protection turns the driver off and turns it on in every switching cycle to continually monitor the driver current.

Overvoltage Protection (OVP)

The flow chart below illustrates the functions of L_x OVP and LEDOVP. L_x OVP protects the device from high voltage due to the disconnection of white LED string. To release the latch-type L_x OVP or LEDOVP, set the CE pin low or decrease the V_{IN} pin voltage below the UVLO detector threshold.

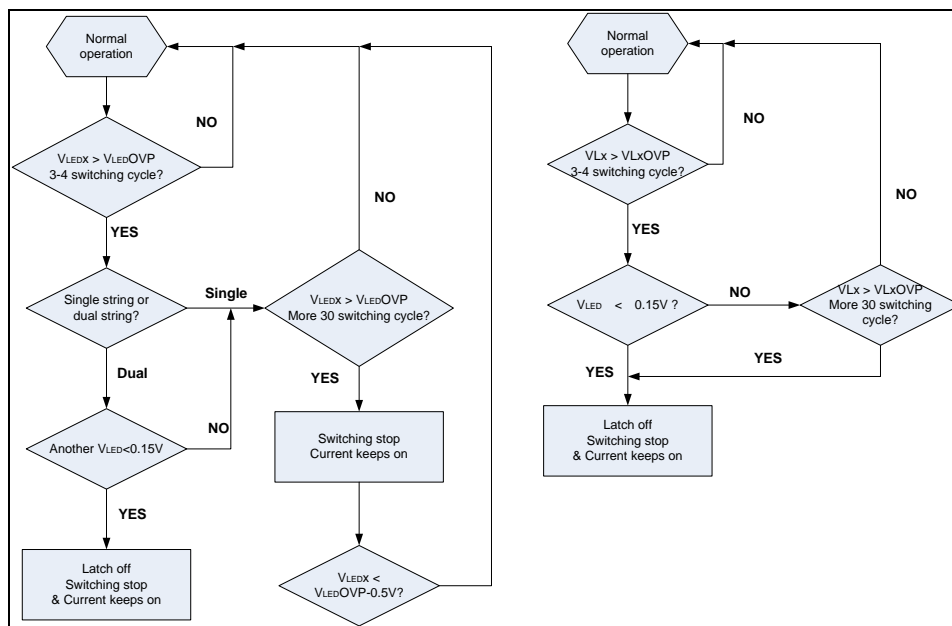

LxOVP and LEDOVP Function Flow

Under Voltage Lockout (UVLO)

UVLO stops the device operation to prevent malfunction when the input (V_{IN}) voltage falls below the UVLO detector threshold.

Thermal Shutdown

Thermal shutdown circuit detects overheating of the converter and stops the device operation to protect it from damage. If the junction temperature of the device exceeds the specified temperature, the thermal shutdown stops the device operation and resumes the device operation if the junction temperature decreases below the thermal shutdown release temperature.

Input Signal Sequencing

The timing of turning on or off of LEDs can be controlled by sequencing the input signals. There are two ways of sequencing the input signals:

Sequencing 1. Send a signal to the PWM pin first and then switch the CE pin to high.

The device shifts from standby mode to active mode to turn the LEDs on.

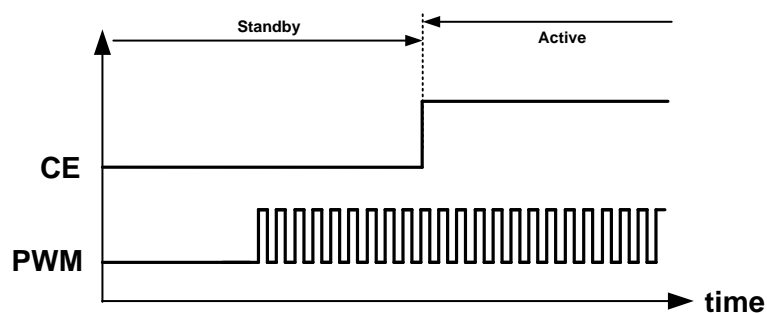

Sequencing 1 Diagram

Sequencing 2. Send a signal to the PWM pin while the CE pin is constantly set high.

The device shifts from standby mode to active mode to turn the LEDs on. If a signal is not sent to the PWM pin more than 50 ms (Max.), the device shifts from active mode to standby mode to turn the LEDs off.

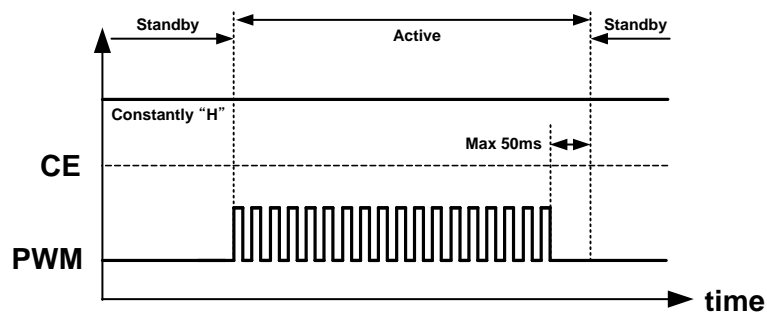

Sequencing 2 Diagram

R1214Z

NO.EA-327-160106

LED Dimming Control

The brightness of the LEDs can be adjusted by applying a PWM signal to the PWM pin. The LED current (I_{LED}) can be controlled by the duty of a PWM signal for the PWM pin. The duty range of a PWM signal can be set in a range of 0.4% to 100% when using a 1- μ F capacitor (C4) and a 30.1-k Ω feedback resistor (R_{ISET}). The relation between the high-duty of the PWM pin (Hduty) and I_{LED} can be calculated as follows:

$$I_{LED} = Hduty \times I_{LEDSET}$$

The frequency of a PWM signal for dimming the LEDs can be set within the range of 200 Hz to 300 kHz; however, it is recommended that a 20-kHz to 100-kHz frequency be used. In the case of using a less than 20-kHz PWM signal, an increase or decrease in an inductor current (I_L) may generate noise in the audible band. To avoid this, connect a 2.2- μ F or more capacitor (C3) between the ISET pin and GND pin. In the case of using a 20-kHz or more PWM signal, C3 is not required. Note that if a PWM signal is changed stepwise, a change in the LED luminance level can be visible as shown in the following figure. To reduce the visible change in the LED luminance level, C3 can also be used.

Reducing the visible change in LED luminance level by using C3

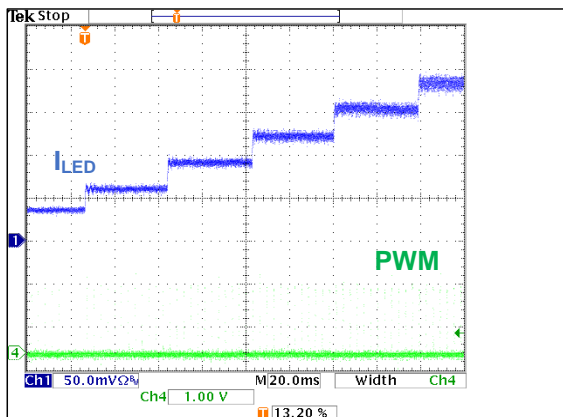

C3 = 0 μ F

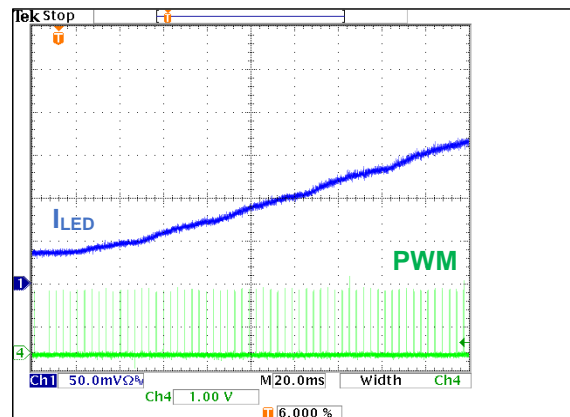

C3 = 2.2 μ F

White LED Current Setting

The LED current for each LED string when a PWM signal applied to the PWM pin is Duty = 100% (I_{LEDSET}) can be determined by the value of feedback resistor (R_{ISET}). I_{LEDSET} can be calculated as follows:

$$I_{LEDSET} = 0.0466 \times R_{ISET} / (40 \text{ k} + R_{ISET})$$

R_{ISET} should be set to 19 k Ω or more. If R_{ISET} with 30.1 k Ω is placed between the ISET and GND pins, I_{LEDSET} will be set to 20 mA.

Operation of Step-Up Dc/Dc Converter And Output Current

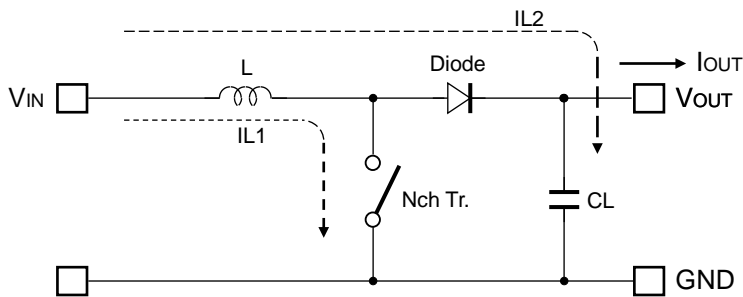

Basic Circuit

Inductor Current (IL) Waveform

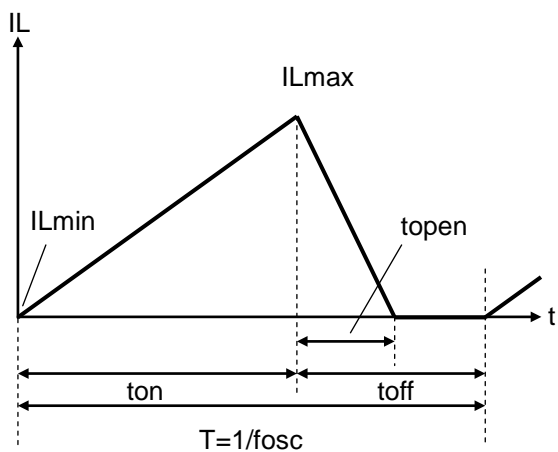

Discontinuous Inductor Current Mode

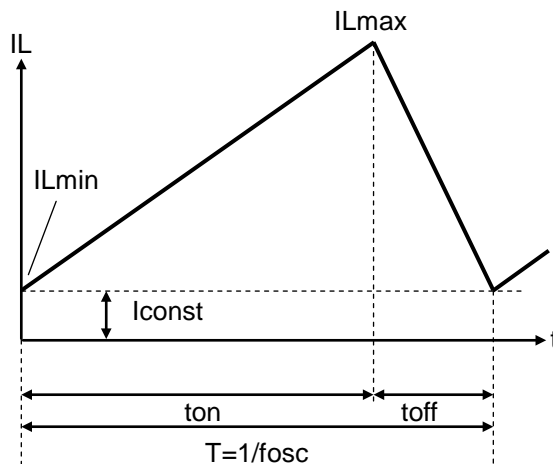

Continuous Inductor Current Mode

The PWM control type of the step-up DC/DC converter has two operation modes characterized by the continuity of inductor current: discontinuous inductor current mode and continuous inductor current mode.

When an Nch transistor is in On-state, the voltage to be applied to the inductor (L) is described as V_{IN} . An increase in the inductor current ($IL1$) can be written as follows:

$$IL1 = V_{IN} \times t_{on} / L \dots\dots\dots \text{Equation 1}$$

In the step-up DC/DC converter circuit, the energy accumulated during the On-state is transferred into the capacitor even in the Off-state. A decrease in the inductor current ($IL2$) can be written as follows:

$$IL2 = (V_{OUT} - V_{IN}) \times t_{open} / L \dots\dots\dots \text{Equation 2}$$

R1214Z

NO.EA-327-160106

In the PWM control, IL1 and IL2 become continuous when $t_{open} = t_{off}$, which is called continuous inductor current mode.

When the device is in continuous inductor current mode and operates in steady-state conditions, the variations of IL1 and IL2 are same:

$$V_{IN} \times t_{on} / L = (V_{OUT} - V_{IN}) \times t_{off} / L \dots\dots\dots \text{Equation 3}$$

Therefore, the duty cycle in continuous inductor current mode is:

$$\text{duty (\%)} = t_{on} / (t_{on} + t_{off}) = (V_{OUT} - V_{IN}) / V_{OUT} \dots\dots\dots \text{Equation 4}$$

When $t_{open} = t_{off}$, the average of IL1 is:

$$IL1 (\text{Ave.}) = V_{IN} \times t_{on} / (2 \times L) \dots\dots\dots \text{Equation 5}$$

If the input voltage (V_{IN}) is equal to the output voltage (V_{OUT}), the output current (I_{OUT}) is:

$$I_{OUT} = V_{IN}^2 \times t_{on} / (2 \times L \times V_{OUT}) \dots\dots\dots \text{Equation 6}$$

If I_{OUT} is larger than Equation 6, the device switches to continuous inductor current mode

The peak inductor current (IL_{max}) is:

$$IL_{max} = I_{OUT} \times V_{OUT} / V_{IN} + V_{IN} \times t_{on} / (2 \times L) \dots\dots\dots \text{Equation 7}$$

$$IL_{max} = I_{OUT} \times V_{OUT} / V_{IN} + V_{IN} \times T \times (V_{OUT} - V_{IN}) / (2 \times L \times V_{OUT}) \dots\dots\dots \text{Equation 8}$$

As a result, IL_{max} becomes larger compared to I_{OUT} . The overcurrent protection circuit operates if the IL_{max} becomes more than the L_x current limit. When considering the input and output conditions or selecting the external components, please pay attention to IL_{max} .

Notes: The above calculations are based on the ideal operation of the device. They do not include the losses caused by the external components or Nch transistor. The actual maximum output current will be 50% to 80% of the above calculation results. Especially, if IL is large or V_{IN} is low, it may cause the switching losses. An approximately 0.8 V forward voltage (V_F) of diode should be added to V_{OUT} in the above calculations.

APPLICATION INFORMATION

Typical Application Circuits

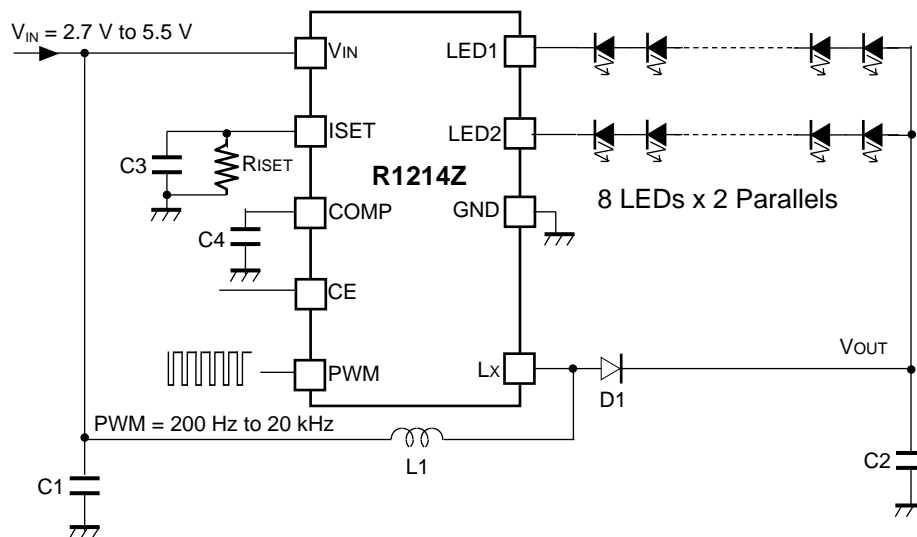

Typical Application: 8 LEDs in series x 2 parallels, 200 Hz to 20 kHz PWM signal

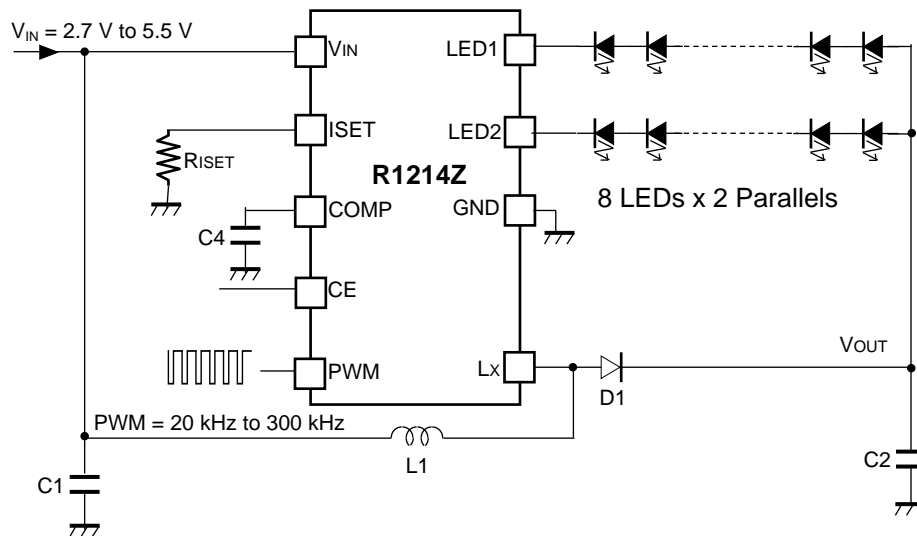

Typical Application: 8 LEDs in series x 2 parallels, 20 kHz to 300 kHz PWM signal

R1214Z

NO.EA-327-160106

Recommended Inductors

L1 (μH)	Product Name	Rated Current (mA)	Inductor Size (mm)	Components No.
10	R1214Z221x (750 kHz)	550	2.5 x 2.0 x 1.0	VLS252010ET-100M
10		620	3.0 x 2.5 x 1.2	VLF302512MT-100M
10		900	4.0 x 3.2 x 1.2	VLF403212MT-100M
10		1320	5.0 x 4.0 x 1.2	VLF504012MT-100M
22	R1214Z211x (450 kHz)	430	3.0 x 2.5 x 1.2	VLF302512MT-220M
22		540	4.0 x 3.2 x 1.2	VLF403212MT-220M
22		890	5.0 x 4.0 x 1.2	VLF504012MT-220M

Recommended Components

Symbol	Description	Rated Voltage (V)	Value	Components No.
C1 (C _{IN})	Ceramic Capacitor	6.3	4.7 μF or more	C1608JB0J475K
C2 (C _{OUT})	Ceramic Capacitor	50	2.2 μF or more R1214Z211x	C2012X5R1H225K
			1.0 μF or more R1214Z221x	C2012X5R1H105K
C3	Ceramic Capacitor	6.3	2.2 μF or more	-
C4	Ceramic Capacitor	6.3	0.1 μF to 1μF	-
D1	Diode	60	-	CRS12
		60	-	RB060M-60

Cautions in Selecting External Components**Selection of Inductor**

The peak inductor current (I_{Lmax}) under steady operation can be calculated as follows:

$$I_{Lmax} = 1.25 \times I_{LED} \times V_{OUT} / V_{IN} + 0.5 \times V_{IN} \times (V_{OUT} - V_{IN}) / (L \times V_{OUT} \times f_{osc})$$

When starting up the device or adjusting the brightness of LED lights using the PWM pin, a large transient current may flow into an inductor (L1). I_{Lmax} should be equal or smaller than the L_x current limit (I_{LxLIM}) of the device. It is recommended that a 10 μH to 22 μH inductor be used.

Selection of Capacitor

Set a 4.7 μF or more input capacitor (C1) between the V_{IN} and GND pins as close as possible to the pins.

Set a 2.2 μF or more output capacitor (C2) between the V_{OUT} and GND pins for R1214Zx11x.

Set a 1 μF or more output capacitor (C2) between the V_{OUT} and GND pins for R1214Zx21x.

If a PWM input signal is within the range of 200 Hz to 20 kHz, set a 2.2 μF or more capacitor (C3) between the ISET and GND pins. If a PWM input signal is within the range of 20 kHz to 300 kHz, a capacitor (C3) is not required.

Set a capacitor (C4) 0.1 μF between the COMP and GND pins.

Selection of SBD (Schottky Barrier Diode)

Choose a diode that has low forward voltage (V_{F}), low reverse current (I_{R}), and low parasitic capacitance.

SBD is an ideal type of diode for R1214Z since it has low V_{F} , low I_{R} , and low parasitic capacitance.

TECHNICAL NOTES

The performance of a power source circuit using this device is highly dependent on a peripheral circuit. A peripheral component or the device mounted on PCB should not exceed a rated voltage, a rated current or a rated power. When designing a peripheral circuit, please be fully aware of the following points.

Unused LED Current Source

Unused LED pin should be connected to GND.

TYPICAL CHARACTERISTICS

Note: Typical Characteristics are intended to be used as reference data; they are not guaranteed.

1) Efficiency vs. Output Current

1-1) Efficiency of R1214Z211A with Different Input Voltages

VLF403012-100M/ 6s2p LEDs

(V_{OUT} = 16.9 V at 40 mA per 1 String)

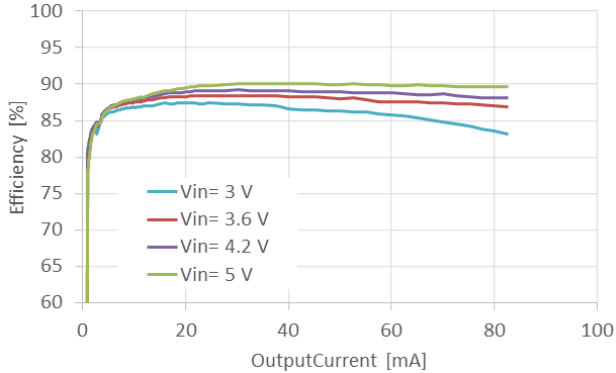

VLF403012-220M/ 6s2p LEDs

(V_{OUT} = 16.9 V at 40 mA per 1 String)

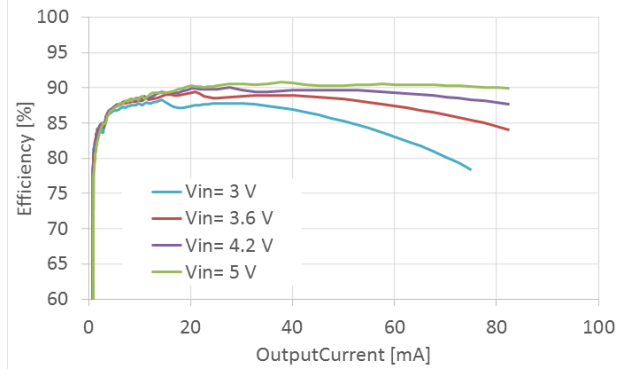

VLF403012-100M/ 8s2p LEDs

(V_{OUT} = 22.3 V at 40 mA per 1 String)

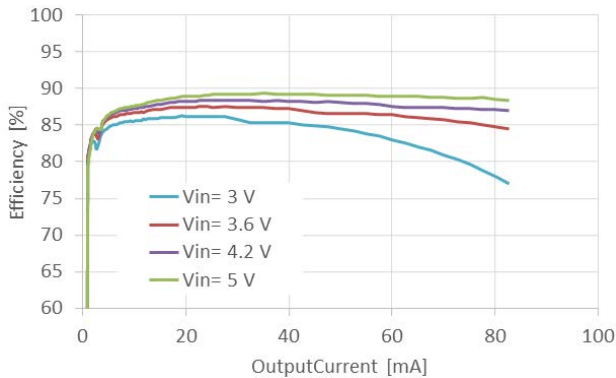

VLF403012-220M/ 8s2p LEDs

(V_{OUT} = 22.3 V at 40 mA per 1 String)

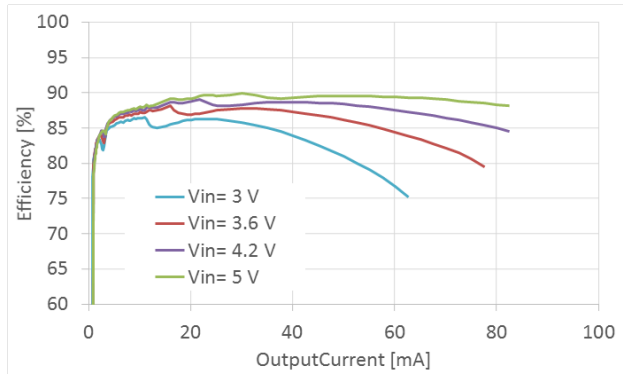

1-2) Efficiency of R1214Z211A with Different Inductors (V_{OUT} = 28 V at 80 mA)

V_{IN} = 3.6 V/ 6s2p LEDs

(V_{OUT} = 16.9 V at 40 mA per 1 String)

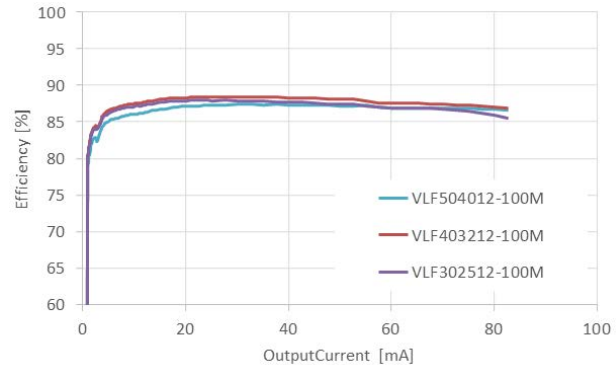

V_{IN} = 3.6 V/ 6s2p LEDs

(V_{OUT} = 16.9 V at 40 mA per 1 String)

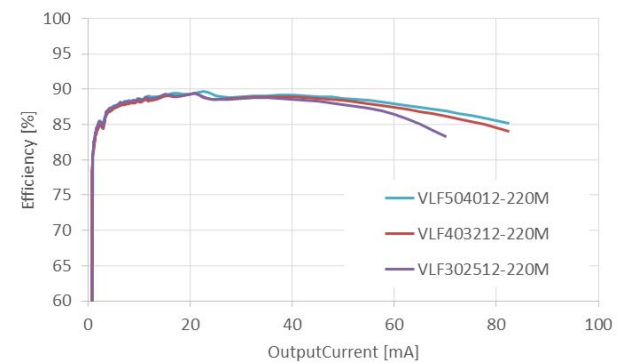

$V_{IN} = 3.6\text{ V}$ / 8s2p LEDs
 ($V_{OUT} = 22.3\text{ V}$ at 40 mA per 1 String)

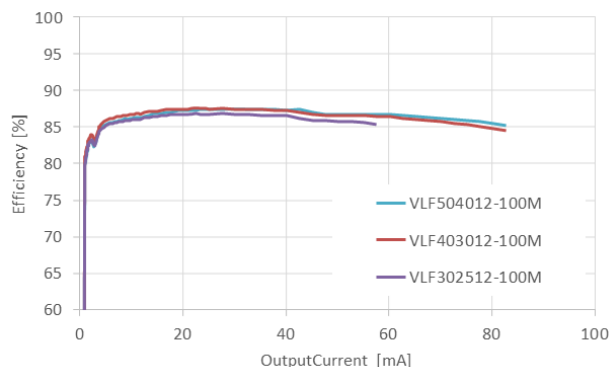

$V_{IN} = 3.6\text{ V}$ / 8s2p LEDs
 ($V_{OUT} = 22.3\text{ V}$ at 40 mA per 1 String)

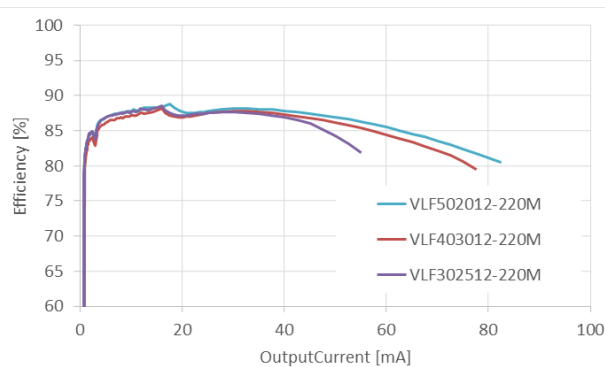

2) PWM Dimming Duty vs. I_{LED} ($R_{SET} = 30.1\text{ k}\Omega$)

$V_{IN} = 3.6\text{ V}$ / 8s2p LEDs
 ($f_{PWM} = 20\text{ kHz}$)
 ($R_{SET} = 30.1\text{ k}\Omega$)

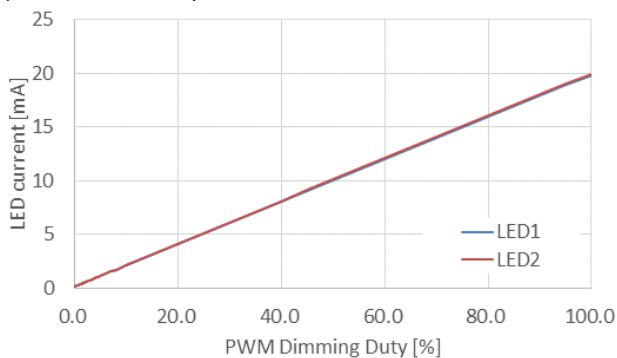

$V_{IN} = 3.6\text{ V}$ / 8s2p LEDs
 ($f_{PWM} = 20\text{ kHz}$)
 ($R_{SET} = 30.1\text{ k}\Omega$)



3) I_{LED} Waveform in the VFM Mode

$V_{IN} = 3.6\text{ V}$ / 8s2p LEDs
 R1214Z211A ($f_{PWM} = 10\text{ kHz}$, PWMduty = 10%)
 ($R_{SET} = 30.1\text{ k}\Omega$)

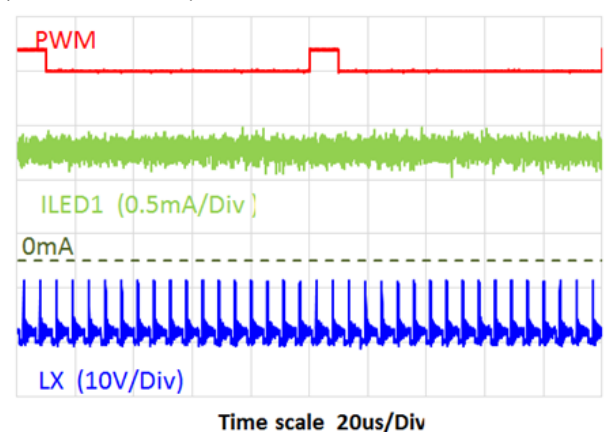

$V_{IN} = 3.6\text{ V}$ / 8s2p LEDs
 R1214Z221A ($f_{PWM} = 10\text{ kHz}$, PWMduty = 10%)
 ($R_{SET} = 30.1\text{ k}\Omega$)

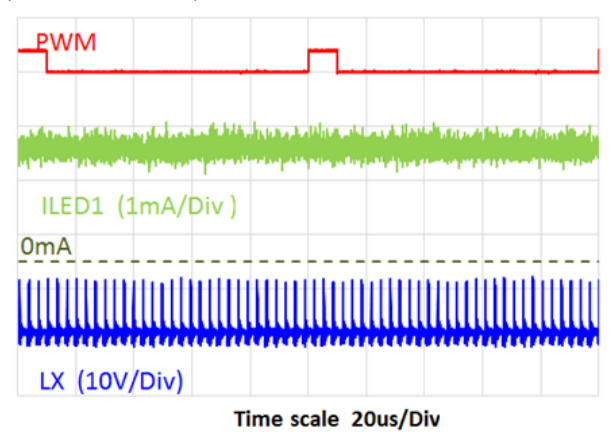

R1214Z

NO.EA-327-160106

4) Startup/ Shutdown Waveform

$V_{IN} = 3.6\text{ V}$ / 8s2p LEDs
R1214Zxxxx ($f_{PWM} = 20\text{ kHz}$, PWMduty = 50%)
($R_{ISET} = 30.1\text{ k}\Omega$)



$V_{IN} = 3.6\text{ V}$ / 8s2p LEDs
R1214Zxxxx ($f_{PWM} = 20\text{ kHz}$, PWMduty = 100%)
($R_{ISET} = 30.1\text{ k}\Omega$)

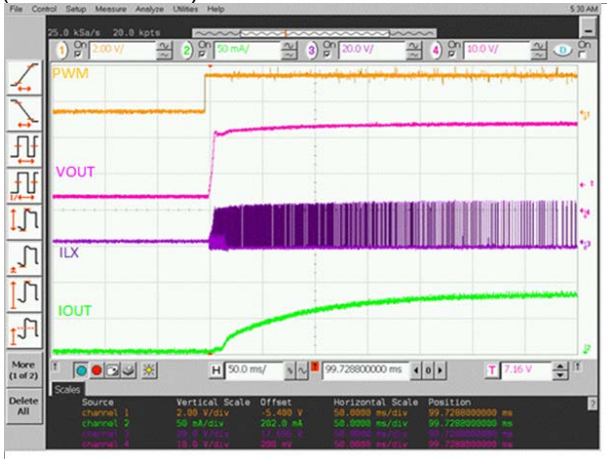

$V_{IN} = 3.6\text{ V}$ / 8s2p LEDs
R1214Zxxxx ($f_{PWM} = 20\text{ kHz}$, PWMduty = 50%)
($R_{ISET} = 30.1\text{ k}\Omega$)

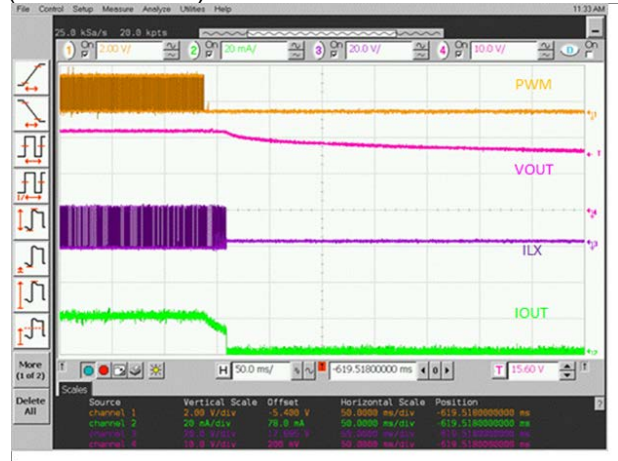

$V_{IN} = 3.6\text{ V}$ / 8s2p LEDs
R1214Zxxxx ($f_{PWM} = 20\text{ kHz}$, PWMduty = 100%)
($R_{ISET} = 30.1\text{ k}\Omega$)



5) Load Transient Response

$V_{IN} = 3.6\text{ V} / 8\text{s}2\text{p LEDs}$
 R1214Z221A ($f_{PWM} = 20\text{kHz}$, $PWM\text{duty} = 10\% \rightarrow 90\%$)
 ($R_{ISET} = 30.1\text{ k}\Omega / C_{ISET} = 0\text{ }\mu\text{F}$)

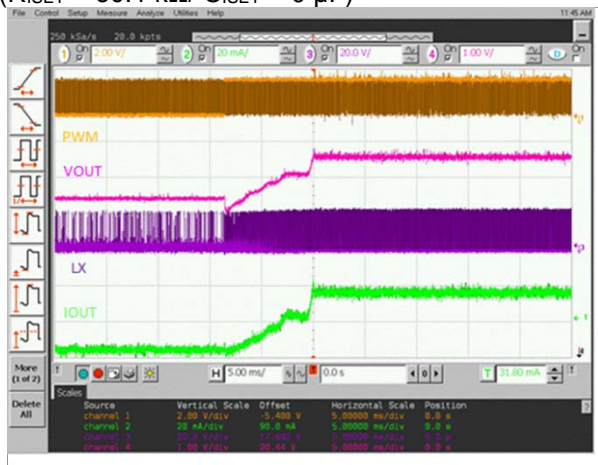

$V_{IN} = 3.6\text{ V} / 8\text{s}2\text{p LEDs}$
 R1214Z221A ($f_{PWM} = 20\text{kHz}$, $PWM\text{duty} = 90\% \rightarrow 10\%$)
 ($R_{ISET} = 30.1\text{ k}\Omega / C_{ISET} = 0\text{ }\mu\text{F}$)

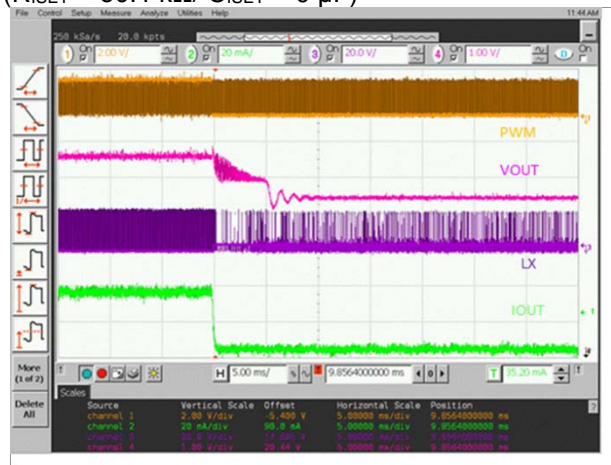

$V_{IN} = 3.6\text{ V} / 8\text{s}2\text{p LEDs}$
 R1214Z221A ($f_{PWM} = 20\text{kHz}$, $PWM\text{duty} = 10\% \rightarrow 90\%$)
 ($R_{ISET} = 30.1\text{ k}\Omega / C_{ISET} = 2.0\text{ }\mu\text{F}$)

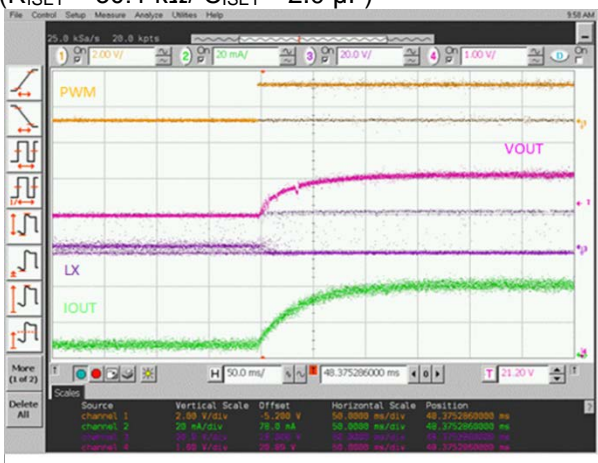

$V_{IN} = 3.6\text{ V} / 8\text{s}2\text{p LEDs}$
 R1214Z221A ($f_{PWM} = 20\text{kHz}$, $PWM\text{duty} = 90\% \rightarrow 10\%$)
 ($R_{ISET} = 30.1\text{ k}\Omega / C_{ISET} = 2.0\text{ }\mu\text{F}$)



R1214Z

NO.EA-327-160106

6) Electrical Characteristics

6-1) UVLO Voltage vs. Ambient Temperature

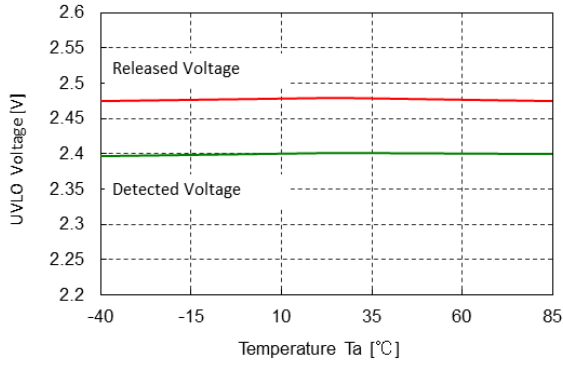

6-2) LED Regulated Voltage vs. Ambient Temperature

R1214ZxxxA/B

R1214ZxxxC/D

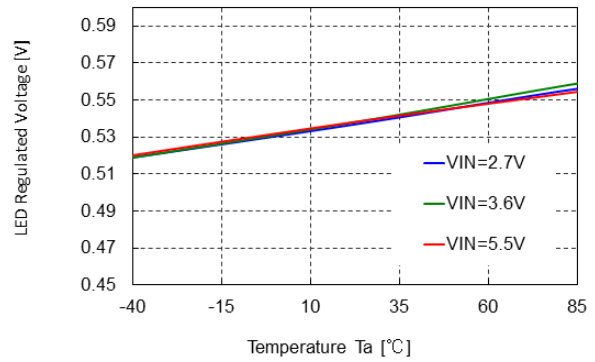
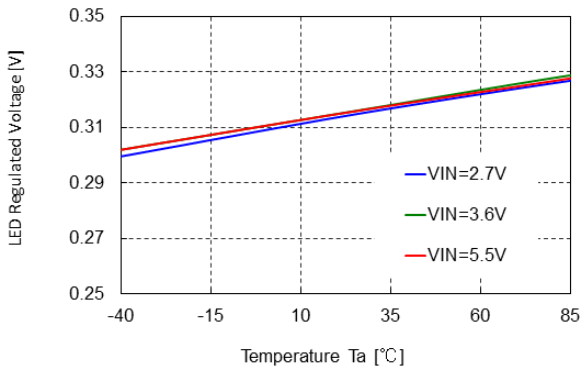

6-3) LED Current vs. Ambient Temperature

R1214ZxxxA/B

R1214ZxxxC/D

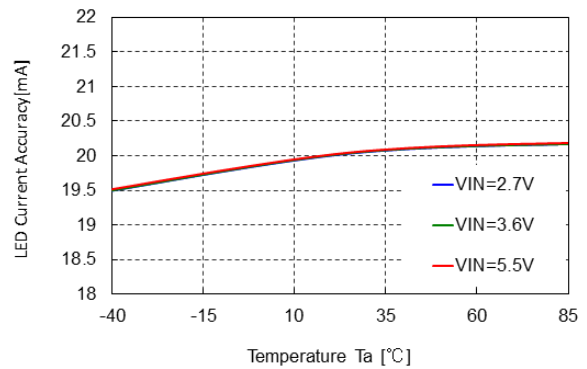
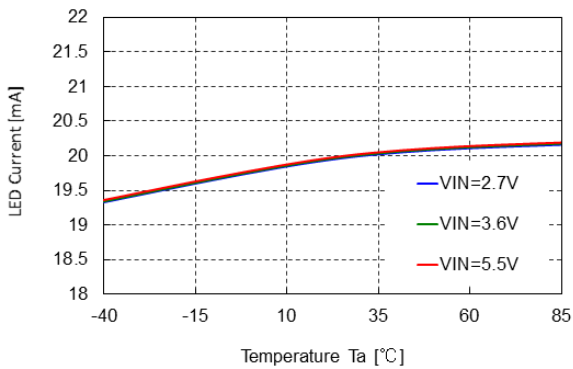

6-4) Nch ON Resistance vs. Ambient Temperature

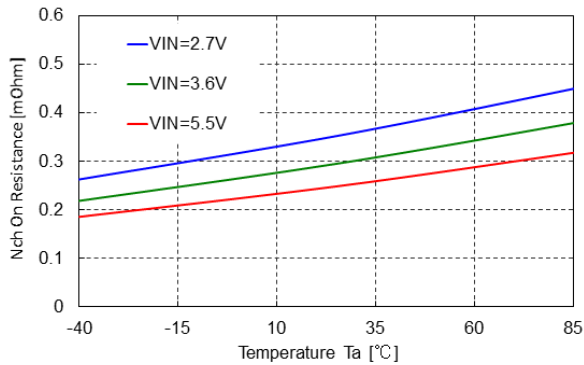

6-5) Oscillator Frequency vs. Ambient Temperature

R1214Z211x

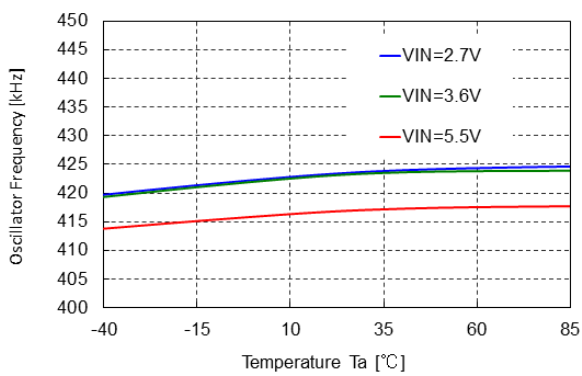

R1214Z221x

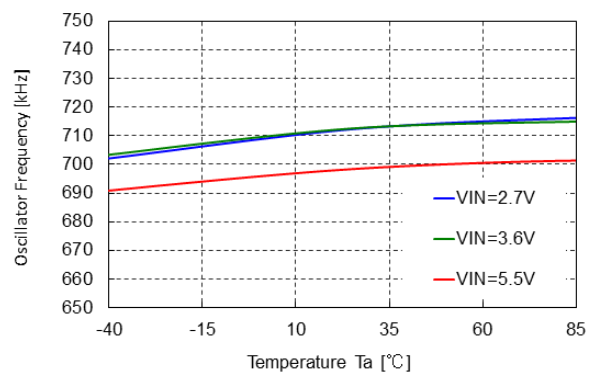

6-6) Maxduty vs. Ambient Temperature

R1214Z211x

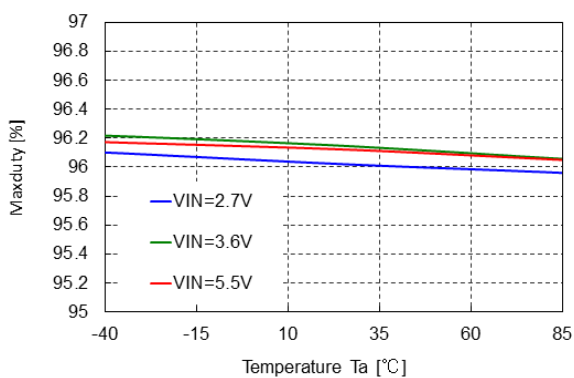

R1214Z221x

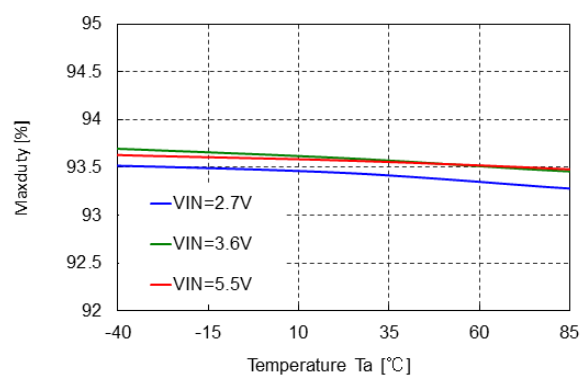

6-7) LxOVP Detect Voltage vs. Ambient Temperature

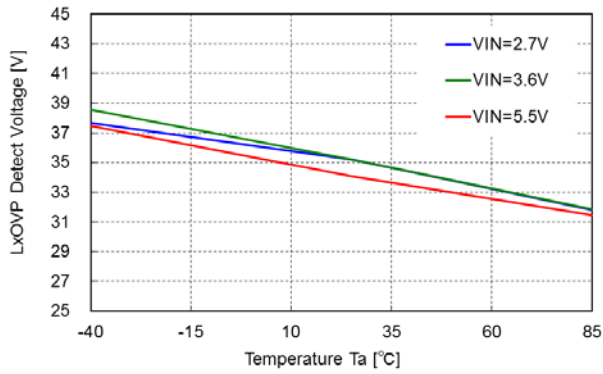

6-8) LEDOVP Detect Voltage vs. Ambient Temperature

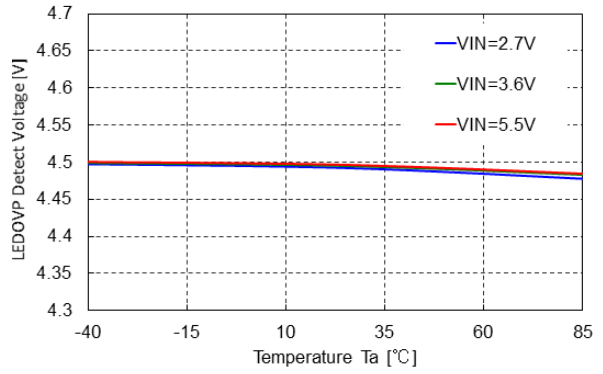

6-9) Soft start Time vs. Ambient Temperature

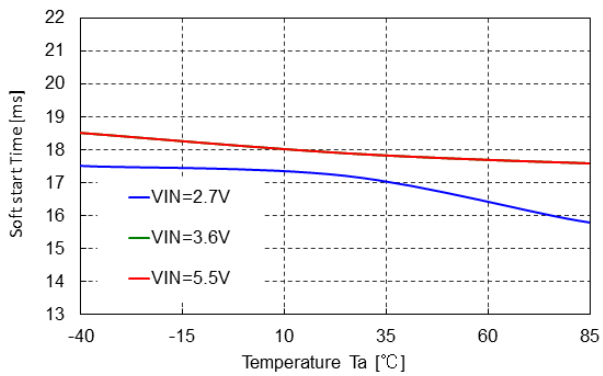

6-10) Lx Limit Current vs. Ambient Temperature

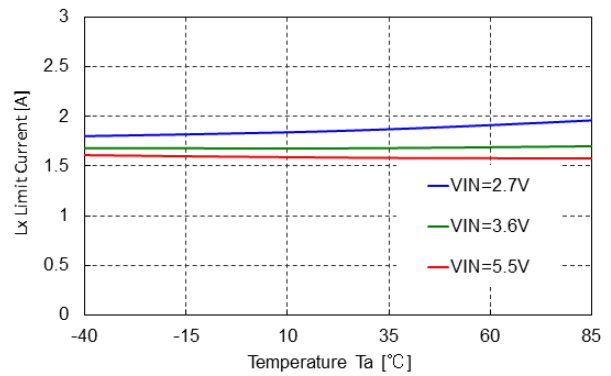

The power dissipation of the package is dependent on PCB material, layout, and environmental conditions. The following conditions are used in this measurement.

Measurement Conditions

High Wattage Land Pattern	
Environment	Mounting on Board (Wind Velocity = 0 m/s)
Board Material	Glass Cloth Epoxy Plastic (Four-layers)
Board Dimensions	76.2 mm × 114.3 mm × 1.6 mm
Copper Ratio	Outer Layers (First and Fourth Layers): Approx. 60% Inner Layers (Second and Third Layers): 100%

Measurement Result

(Ta = 25°C, Tjmax = 125°C)

High Wattage Land Pattern	
Power Dissipation	1190 mW
Thermal Resistance	$\theta_{ja} = (125 - 25^\circ\text{C}) / 1.19 \text{ W} = 84^\circ\text{C/W}$

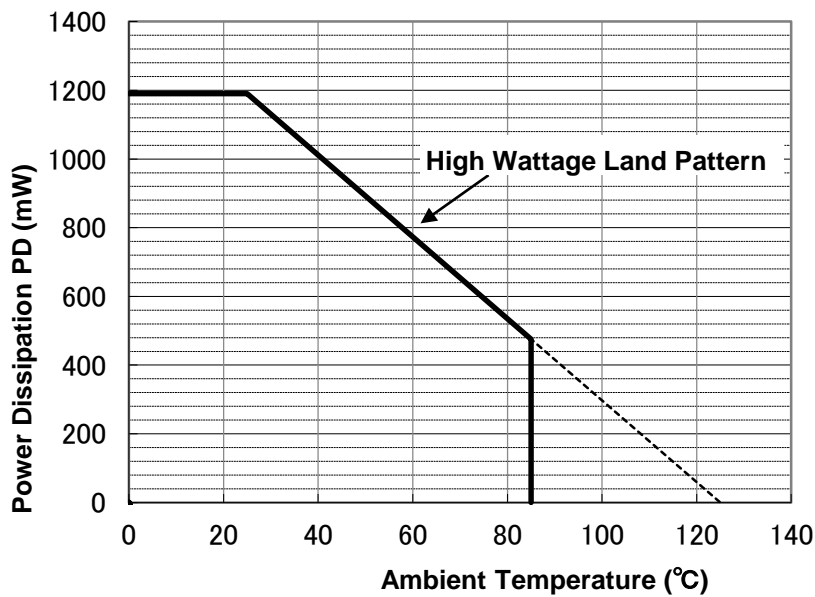

Power Dissipation vs. Ambient Temperature

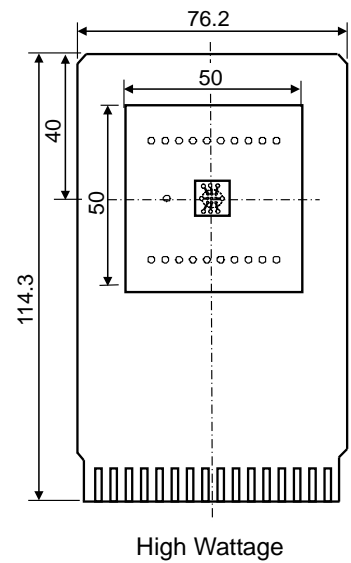

○ IC Mount Area (mm)

Measurement Board Pattern

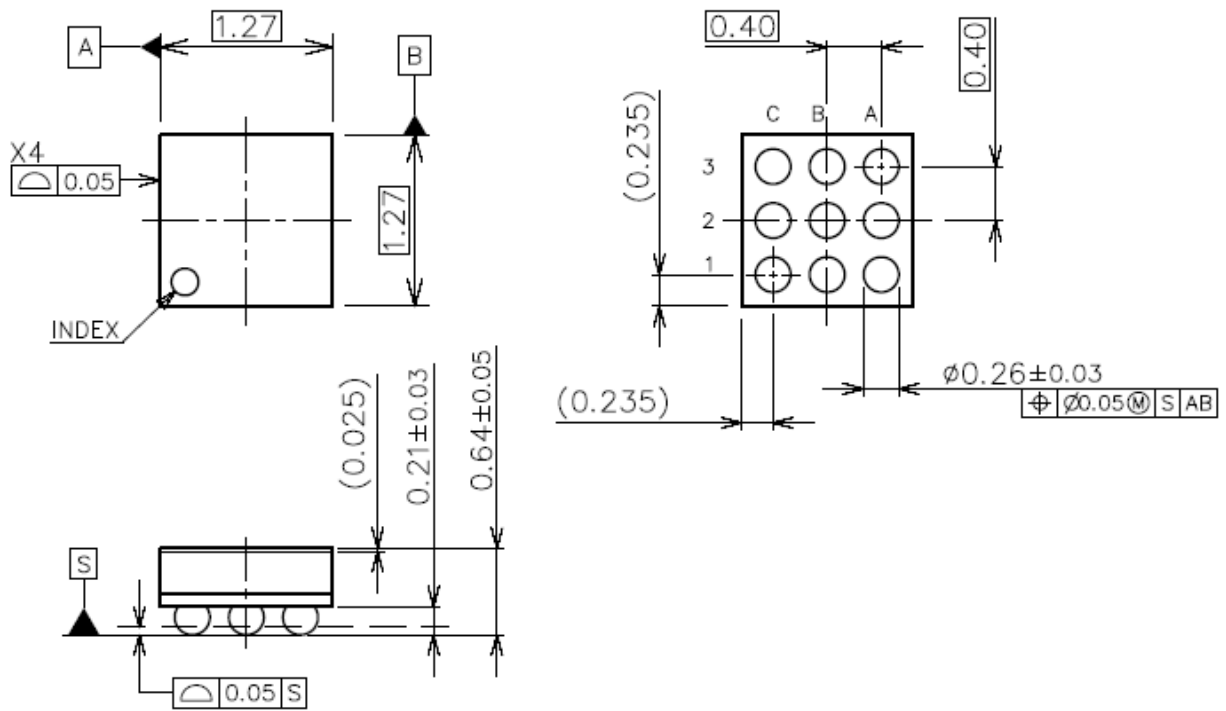

WLCSP-9-P1 Package Dimensions (Unit: mm)



1. The products and the product specifications described in this document are subject to change or discontinuation of production without notice for reasons such as improvement. Therefore, before deciding to use the products, please refer to Ricoh sales representatives for the latest information thereon.
2. The materials in this document may not be copied or otherwise reproduced in whole or in part without prior written consent of Ricoh.
3. Please be sure to take any necessary formalities under relevant laws or regulations before exporting or otherwise taking out of your country the products or the technical information described herein.
4. The technical information described in this document shows typical characteristics of and example application circuits for the products. The release of such information is not to be construed as a warranty of or a grant of license under Ricoh's or any third party's intellectual property rights or any other rights.
5. The products listed in this document are intended and designed for use as general electronic components in standard applications (office equipment, telecommunication equipment, measuring instruments, consumer electronic products, amusement equipment etc.). Those customers intending to use a product in an application requiring extreme quality and reliability, for example, in a highly specific application where the failure or misoperation of the product could result in human injury or death (aircraft, spacevehicle, nuclear reactor control system, traffic control system, automotive and transportation equipment, combustion equipment, safety devices, life support system etc.) should first contact us.
6. We are making our continuous effort to improve the quality and reliability of our products, but semiconductor products are likely to fail with certain probability. In order to prevent any injury to persons or damages to property resulting from such failure, customers should be careful enough to incorporate safety measures in their design, such as redundancy feature, fire containment feature and fail-safe feature. We do not assume any liability or responsibility for any loss or damage arising from misuse or inappropriate use of the products.
7. Anti-radiation design is not implemented in the products described in this document.
8. Please contact Ricoh sales representatives should you have any questions or comments concerning the products or the technical information.



Ricoh is committed to reducing the environmental loading materials in electrical devices with a view to contributing to the protection of human health and the environment.

Ricoh has been providing RoHS compliant products since April 1, 2006 and Halogen-free products since April 1, 2012.

RICOH RICOH ELECTRONIC DEVICES CO., LTD.

<http://www.e-devices.ricoh.co.jp/en/>

Sales & Support Offices

RICOH ELECTRONIC DEVICES CO., LTD.

Higashi-Shinagawa Office (International Sales)
3-32-3, Higashi-Shinagawa, Shinagawa-ku, Tokyo 140-8655, Japan
Phone: +81-3-5479-2857 Fax: +81-3-5479-0502

RICOH EUROPE (NETHERLANDS) B.V.

Semiconductor Support Centre
Prof. W.H. Keesomlaan 1, 1183 DJ Amstelveen, The Netherlands
Phone: +31-20-5474-309

RICOH INTERNATIONAL B.V. - German Branch

Semiconductor Sales and Support Centre
Oberrather Strasse 6, 40472 Düsseldorf, Germany
Phone: +49-211-6546-0

RICOH ELECTRONIC DEVICES KOREA CO., LTD.

3F, Haesung Bldg, 504, Teheran-ro, Gangnam-gu, Seoul, 135-725, Korea
Phone: +82-2-2135-5700 Fax: +82-2-2051-5713

RICOH ELECTRONIC DEVICES SHANGHAI CO., LTD.

Room 403, No.2 Building, No.690 Bibo Road, Pu Dong New District, Shanghai 201203, People's Republic of China
Phone: +86-21-5027-3200 Fax: +86-21-5027-3299

RICOH ELECTRONIC DEVICES CO., LTD.

Taipei office
Room 109, 10F-1, No.51, Hengyang Rd., Taipei City, Taiwan (R.O.C.)
Phone: +886-2-2313-1621/1622 Fax: +886-2-2313-1623

Mouser Electronics

Authorized Distributor

Click to View Pricing, Inventory, Delivery & Lifecycle Information:

[Ricoch Electronics:](#)

[R1214Z221A-E2-F](#) [R1214Z211B-E2-F](#)

Компания «Океан Электроники» предлагает заключение долгосрочных отношений при поставках импортных электронных компонентов на взаимовыгодных условиях!

Наши преимущества:

- Поставка оригинальных импортных электронных компонентов напрямую с производств Америки, Европы и Азии, а так же с крупнейших складов мира;
- Широкая линейка поставок активных и пассивных импортных электронных компонентов (более 30 млн. наименований);
- Поставка сложных, дефицитных, либо снятых с производства позиций;
- Оперативные сроки поставки под заказ (от 5 рабочих дней);
- Экспресс доставка в любую точку России;
- Помощь Конструкторского Отдела и консультации квалифицированных инженеров;
- Техническая поддержка проекта, помощь в подборе аналогов, поставка прототипов;
- Поставка электронных компонентов под контролем ВП;
- Система менеджмента качества сертифицирована по Международному стандарту ISO 9001;
- При необходимости вся продукция военного и аэрокосмического назначения проходит испытания и сертификацию в лаборатории (по согласованию с заказчиком);
- Поставка специализированных компонентов военного и аэрокосмического уровня качества (Xilinx, Altera, Analog Devices, Intersil, Interpoint, Microsemi, Actel, Aeroflex, Peregrine, VPT, Syfer, Eurofarad, Texas Instruments, MS Kennedy, Miteq, Cobham, E2V, MA-COM, Hittite, Mini-Circuits, General Dynamics и др.);

Компания «Океан Электроники» является официальным дистрибьютором и эксклюзивным представителем в России одного из крупнейших производителей разъемов военного и аэрокосмического назначения «JONHON», а так же официальным дистрибьютором и эксклюзивным представителем в России производителя высокотехнологичных и надежных решений для передачи СВЧ сигналов «FORSTAR».



JONHON

«JONHON» (основан в 1970 г.)

Разъемы специального, военного и аэрокосмического назначения:

(Применяются в военной, авиационной, аэрокосмической, морской, железнодорожной, горно- и нефтедобывающей отраслях промышленности)

«FORSTAR» (основан в 1998 г.)

ВЧ соединители, коаксиальные кабели, кабельные сборки и микроволновые компоненты:

(Применяются в телекоммуникациях гражданского и специального назначения, в средствах связи, РЛС, а так же военной, авиационной и аэрокосмической отраслях промышленности).



Телефон: 8 (812) 309-75-97 (многоканальный)

Факс: 8 (812) 320-03-32

Электронная почта: ocean@oceanchips.ru

Web: <http://oceanchips.ru/>

Адрес: 198099, г. Санкт-Петербург, ул. Калинина, д. 2, корп. 4, лит. А