

Knobs, Molded Phenolic

PH SERIES



PH15181/4



| Tyco | | Straight Knurl Less Indicator Line | | | | | |
|-------------|------------|------------------------------------|------------|------------|------------|------------|------------|
| Electronics | Alcoswitch | A | B | C | D | E | F |
| 1437624-2 | PH15181/4 | .996(25.3) | .972(24.7) | .799(20.3) | .472(12.0) | .669(17.0) | .157(3.99) |

PK SERIES



PK50B1/8



PK701/4



| Tyco | | Straight Knurl with Dot Indicator on Skirt | | | | | |
|-------------|------------|--|------------|-------------|------------|------------|-------------|
| Electronics | Alcoswitch | A | B | C | D | E | F |
| 1437624-7 | PK50B1/8 | .748(19.0) | .570(14.5) | .500(12.70) | .055(1.40) | .460(11.7) | .550(13.97) |
| 1437624-6 | PK50B1/4 | .748(19.0) | .570(14.5) | .500(12.70) | .055(1.40) | .460(11.7) | .550(13.97) |
| 1437624-8 | PK70B1/4 | .984(25.0) | .728(18.5) | .710(18.03) | .079(2.01) | .500(12.7) | .590(14.99) |
| 1437624-9 | PK90B1/4 | 1.25(31.8) | .985(25.0) | .870(22.01) | .098(2.49) | .470(11.9) | .595(15.10) |

PK SERIES



PK1100B1/4



| Tyco | | Serrated with Dot Indicator on Top | | | | | |
|-------------|------------|------------------------------------|------------|-------------|------------|-------------|------------|
| Electronics | Alcoswitch | A | B | C | D | E | F |
| 1437624-4 | PK1100B1/8 | .700(17.8) | .643(16.3) | .565(14.35) | .125(3.18) | .453(11.51) | .530(13.5) |

K

P Series

Knobs, Molded Phenolic



PKA SERIES



PKA50B1/4



PKA90B1/4

| Tyco Electronics Alcoswitch | | Ribbed with Line Indicator on Skirt | | | | | |
|-----------------------------|-----------|-------------------------------------|------------|------------|------------|------------|------------|
| | | A | B | C | D | E | F |
| 1-1437624-1 | PKA50B1/8 | .795(20.2) | .580(14.7) | .540(13.7) | .080(2.03) | .450(11.4) | .590(15.0) |
| 1-1437624-0 | PKA50B1/4 | .795(20.2) | .580(14.7) | .540(13.7) | .080(2.03) | .450(11.4) | .590(15.0) |
| 1-1437624-4 | PKA55B1/8 | .780(19.8) | .580(14.7) | .475(12.1) | .135(3.43) | .585(14.9) | .675(17.2) |
| 1-1437624-3 | PKA55B1/4 | .780(19.8) | .580(14.7) | .475(12.1) | .135(3.43) | .585(14.9) | .675(17.2) |
| 1-1437624-5 | PKA70B1/4 | .980(24.9) | .740(18.8) | .680(17.3) | .118(3.00) | .650(16.5) | .750(19.1) |
| 1-1437624-7 | PKA90B1/4 | 1.375(34.9) | .970(24.6) | .670(17.0) | .195(4.95) | .750(19.1) | .840(21.3) |



PKAP SERIES



PKAP50B1/8



PKAP90B1/4

| Tyco Electronics Alcoswitch | | Ribbed with Skirt and Pointer with Indicator Line | | | | | |
|-----------------------------|------------|---|------------|------------|------------|------------|-------------|
| | | A | B | C | D | E | F |
| 1-1437624-8 | PKAP50B1/4 | .787(20.0) | .693(17.6) | .508(12.9) | .082(2.08) | .579(14.7) | .689(17.5) |
| 1-1437624-9 | PKAP50B1/8 | .787(20.0) | .693(17.6) | .508(12.9) | .082(2.08) | .579(14.7) | .689(17.5) |
| 2-1437624-0 | PKAP70B1/4 | .976(24.8) | .874(22.1) | .668(17.0) | .158(4.01) | .634(16.1) | .737(18.72) |

Knobs, Molded Phenolic

PKB SERIES



PKB90B1/4



| | | Fluted with Indicator Line On Skirt | | | | | |
|------------------|------------|-------------------------------------|------------|------------|-----------|------------|------------|
| Tyco Electronics | Alcoswitch | A | B | C | D | E | F |
| 2-1437624-3 | PKB70B1/4 | 1.12(28.3) | .750(19.1) | .670(17.0) | .118(3.0) | .490(12.5) | .600(15.2) |
| 2-1437624-4 | PKB90B1/4 | 1.50(38.1) | 1.02(25.8) | .800(20.3) | .118(3.0) | .705(17.9) | .820(20.8) |

PKD SERIES



PKD60B1/4



PKD100B1/4

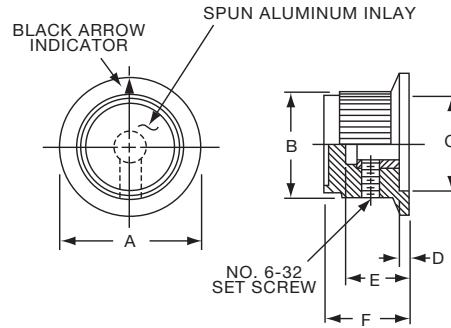

| | | Straight Knurl Aluminum Skirt w/Arrow Indicator | | | | | |
|------------------|------------|---|------------|------------|-----------|------------|------------|
| Tyco Electronics | Alcoswitch | A | B | C | D | E | F |
| 2-1437624-8 | PKD60B1/8 | .780(19.8) | .566(14.4) | .487(12.4) | .059(1.5) | .492(12.5) | .563(14.3) |
| 2-1437624-7 | PKD60B1/4 | .780(19.8) | .566(14.4) | .487(12.4) | .059(1.5) | .492(12.5) | .563(14.3) |
| 3-1437624-1 | PKD70B1/4 | 1.02(25.9) | .750(19.1) | .700(17.8) | .080(2.0) | .490(12.5) | .610(15.5) |
| 2-1437624-5 | PKD100B1/4 | 1.29(32.8) | 1.00(25.4) | .865(22.0) | .050(1.3) | .500(12.7) | .590(15.0) |

PKD SERIES



PKD60B101/8



PKD100B101/4



| | | Straight Knurl Skirt w/0-10 Numerals | | | | | |
|------------------|--------------|--------------------------------------|------------|------------|-----------|------------|------------|
| Tyco Electronics | Alcoswitch | A | B | C | D | E | F |
| 3-1437624-0 | PKD60B101/8 | .780(19.8) | .566(14.4) | .487(12.4) | .059(1.5) | .492(12.5) | .563(14.3) |
| 2-1437624-9 | PKD60B101/4 | .780(19.8) | .566(14.4) | .487(12.4) | .059(1.5) | .492(12.5) | .563(14.3) |
| 3-1437624-2 | PKD70B101/4 | 1.02(25.9) | .750(19.1) | .700(17.8) | .080(2.0) | .490(12.5) | .610(15.5) |
| 2-1437624-6 | PKD100B101/4 | 1.29(32.8) | 1.00(25.4) | .865(22.0) | .050(1.3) | .500(12.7) | .590(15.0) |

K

P Series

Knobs, Molded Phenolic

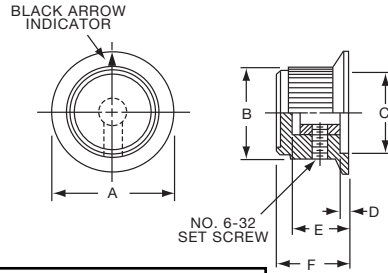

PKDT SERIES



PKDT100B1/4

| Tyco Black Spin Cap with "Diamond Cut" and Arrow Indicator | | | | | | | |
|--|-------------|------------|------------|------------|------------|------------|------------|
| Electronics | Alcoswitch | A | B | C | D | E | F |
| 3-1437624-9 | PKDT70B1/4 | 1.03(26.0) | .738(18.8) | .720(18.3) | .098(2.49) | .500(12.7) | .635(16.1) |
| 3-1437624-3 | PKDT100B1/4 | 1.29(32.8) | 1.02(25.9) | .860(21.8) | .042(1.07) | .500(12.7) | .638(16.2) |



PKDT SERIES



PKDT100B101/4

| Tyco Black Spin Cap with "Diamond Cut" & 0-10 Numerals | | | | | | | |
|--|---------------|------------|------------|------------|------------|------------|------------|
| Electronics | Alcoswitch | A | B | C | D | E | F |
| 3-1437624-8 | PKDT60B101/8 | .778(19.8) | .605(15.4) | .560(12.5) | .060(1.53) | .392(9.96) | .562(14.3) |
| 4-1437624-0 | PKDT70B101/4 | 1.03(26.0) | .738(18.8) | .720(18.3) | .098(2.49) | .500(12.7) | .635(16.1) |
| 3-1437624-4 | PKDT100B101/4 | 1.29(32.8) | 1.02(25.9) | .860(21.8) | .042(1.07) | .500(12.7) | .638(16.2) |

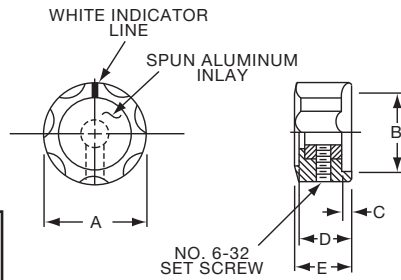

PKE SERIES



PKE90B1/4

| Tyco Fluted with Indicator Line | | | | | |
|---------------------------------|------------|------------|------------|------------|------------|
| Electronics | Alcoswitch | A | B | C | E |
| 4-1437624-4 | PKE60B1/8 | .626(15.9) | .472(12.0) | .091(2.31) | .394(10.0) |
| 4-1437624-3 | PKE60B1/4 | .626(15.9) | .472(12.0) | .091(2.31) | .394(10.0) |
| 4-1437624-5 | PKE90B1/4 | .890(22.6) | .724(18.4) | .098(2.49) | .480(12.2) |



PKES SERIES

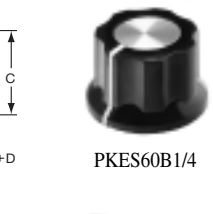

PKES60B1/4

| Tyco Fluted with Skirt and Indicator Line | | | | | | | |
|---|-------------|------------|------------|------------|------------|------------|------------|
| Electronics | Alcoswitch | A | B | C | D | E | F |
| 5-1437624-1 | PKES60B1/8 | .748(19.0) | .618(15.7) | .460(11.7) | .090(2.29) | .370(9.40) | .470(11.9) |
| 5-1437624-0 | PKES60B1/4 | .748(19.0) | .618(15.7) | .460(11.7) | .090(2.29) | .370(9.40) | .470(11.9) |
| 5-1437624-2 | PKES70B1/4 | .855(21.7) | .744(18.9) | .705(17.9) | .080(2.03) | .421(10.7) | .526(13.4) |
| 5-1437624-3 | PKES90B1/4 | 1.01(25.7) | .889(22.6) | .846(21.5) | .079(2.01) | .421(10.7) | .570(14.5) |
| 4-1437624-6 | PKES120B1/4 | 1.30(32.9) | 1.16(29.5) | 1.02(25.9) | .118(3.00) | .500(12.7) | .628(16.0) |
| 4-1437624-7 | PKES140B1/4 | 1.50(38.1) | 1.37(34.9) | 1.22(30.9) | .118(3.00) | .540(13.7) | .693(17.6) |
| 4-1437624-8 | PKES150B1/4 | 1.77(44.9) | 1.55(39.4) | 1.41(35.9) | .118(3.00) | .733(18.6) | .831(21.1) |



PKES70B1/4

Knobs, Molded Phenolic

PKF SERIES



PKF50B1/8



| Tyco Plain Quadrate with Indicator Line & Arrow | | | | | |
|---|------------|------------|-------------|-------------|------------|
| Electronics | Alcoswitch | A | B | C | D |
| 5-1437624-5 | PKF50B1/8 | .670(17.0) | .454(11.53) | .570(14.48) | .520(13.2) |

PKG SERIES



PKG40B1/8



| Tyco Ribbed with Indicator Line | | | | | | | |
|---------------------------------|------------|------------|------------|------------|------------|-------------|------------|
| Electronics | Alcoswitch | A | B | C | D | E | F |
| 5-1437624-9 | *PKG40B1/8 | .437(11.1) | .410(10.4) | .304(7.72) | .079(2.00) | .385(9.78) | .472(12.0) |
| 6-1437624-1 | PKG50B1/8 | .551(14.0) | .500(12.7) | .442(10.7) | .056(1.42) | .395(10.03) | .512(13.0) |
| 6-1437624-0 | PKG50B1/4 | .551(14.0) | .500(12.7) | .442(10.7) | .056(1.42) | .395(10.03) | .512(13.0) |

*Note: Knob uses #4-40 set screw

Knobs, Molded Phenolic

PKG SERIES



PKG70B1/8

| Tyco | | Ribbed with Indicator Line | | | | | |
|-------------|------------|----------------------------|------------|------------|------------|------------|------------|
| Electronics | Alcoswitch | A | B | C | D | E | F |
| 6-1437624-6 | PKG60B1/8 | .660(16.8) | .615(15.6) | .551(14.0) | .080(2.03) | .430(10.9) | .551(14.0) |
| 6-1437624-5 | PKG60B1/4 | .660(16.8) | .615(15.6) | .551(14.0) | .080(2.03) | .430(10.9) | .551(14.0) |
| 6-1437624-8 | PKG70B1/8 | .740(18.8) | .698(17.7) | .591(15.0) | .080(2.03) | .453(11.5) | .559(14.2) |
| 6-1437624-7 | PKG70B1/4 | .740(18.8) | .698(17.7) | .591(15.0) | .080(2.03) | .453(11.5) | .559(14.2) |

PKG SERIES



PKG90B1/4

| Tyco | | Ribbed with Indicator Line | | | | | |
|-------------|------------|----------------------------|------------|------------|------------|------------|-------------|
| Electronics | Alcoswitch | A | B | C | D | E | F |
| 7-1437624-0 | PKG90B1/8 | .862(21.9) | .811(20.6) | .710(18.0) | .080(2.03) | .450(11.4) | .550(13.97) |
| 6-1437624-9 | PKG90B1/4 | .862(21.9) | .811(20.6) | .710(18.0) | .080(2.03) | .450(11.4) | .550(13.97) |
| 5-1437624-7 | PKG100B1/4 | 1.055(26.80) | 1.01(25.5) | .920(23.4) | .080(2.03) | .430(10.9) | .555(14.1) |
| 5-1437624-8 | PKG125B1/4 | 1.248(31.70) | 1.20(30.4) | .690(17.5) | .080(2.03) | .430(10.9) | .565(14.4) |

PKGP SERIES

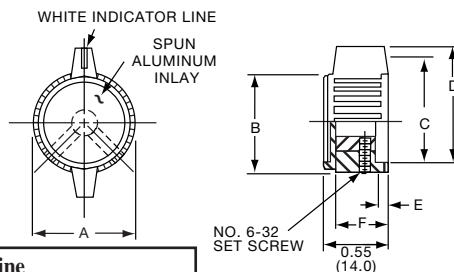

PKGP70B1/4

| Tyco | | Ribbed with Bar Pointers and Indicator Line | | | | | |
|-------------|-------------|---|------------|------------|------------|------------|------------|
| Electronics | Alcoswitch | A | B | C | D | E | F |
| 7-1437624-2 | PKGP70B1/4 | .740(18.8) | .700(17.8) | .590(15.0) | .990(25.2) | .080(2.03) | .460(11.7) |
| 7-1437624-3 | PKGP90B1/4 | .860(21.8) | .810(20.6) | .700(17.8) | 1.28(32.5) | .080(2.03) | .460(11.7) |
| 7-1437624-1 | PKGP100B1/4 | 1.05(26.2) | 1.00(25.4) | .900(22.9) | 1.62(41.2) | .080(2.03) | .480(12.2) |

PKJ SERIES



PKJ50B1/8

| Tyco | | Straight Knurl with Bar Pointers and Indicator Line | | | | | |
|-------------|------------|---|------------|------------|------------|------------|-----------|
| Electronics | Alcoswitch | A | B | C | D | E | F |
| 7-1437624-5 | PKJ50B1/8 | .500(12.7) | .512(13.0) | .420(10.7) | .577(14.7) | .429(10.9) | .113(2.9) |
| 7-1437624-4 | *PKJ50B1/4 | .500(12.7) | .512(13.0) | .420(10.7) | .577(14.7) | .429(10.9) | .113(2.9) |
| 7-1437624-6 | PKJ60B1/4 | .630(16.0) | .530(13.5) | .468(11.9) | .758(19.3) | .440(11.2) | .110(2.8) |
| 7-1437624-7 | PKJ70B1/4 | .760(19.3) | .555(14.1) | .545(13.8) | .915(23.2) | .450(11.4) | .118(3.0) |

*Note: Knob uses #4-40 set screw



PKJ70B1/4

Knobs, Molded Phenolic

PKJT SERIES



PKJT50B1/4



PKJT70B1/4



| Straight Knurl with Bar Pointer & Indicator Line and Aluminum Spin Cap | | | | | | | |
|--|-------------|------------|------------|------------|------------|------------|------------|
| Tyco | | | | | | | |
| Electronics | Alcoswitch | A | B | C | D | E | F |
| 7-1437624-9 | PKJT50B1/8 | .515(13.1) | .585(14.9) | .350(8.89) | .595(15.1) | .414(10.5) | .130(3.30) |
| 7-1437624-8 | *PKJT50B1/4 | .515(13.1) | .585(14.9) | .350(8.89) | .595(15.1) | .414(10.5) | .130(3.30) |
| 8-1437624-0 | PKJT60B1/4 | .640(16.3) | .605(15.4) | .470(11.9) | .760(19.3) | .445(11.3) | .118(3.00) |
| 8-1437624-1 | PKJT70B1/4 | .760(19.3) | .625(15.9) | .550(14.0) | .915(23.2) | .445(11.3) | .118(3.00) |

*Knob uses #4-40 set screw.

PKNT SERIES



PKNT60B1/4

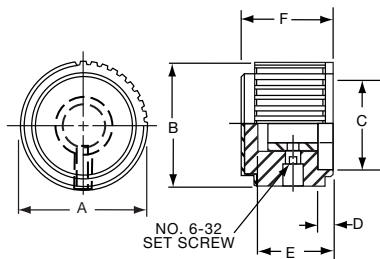

| Black Spin Cap with "Diamond Cut" Less Indicator | | | | | | | |
|--|------------|------------|------------|------------|------------|------------|------------|
| Tyco | | | | | | | |
| Electronics | Alcoswitch | A | B | C | D | E | F |
| 8-1437624-6 | PKNT60B1/8 | .591(15.0) | .579(14.7) | .394(10.0) | .079(2.01) | .394(10.0) | .472(11.9) |
| 8-1437624-5 | PKNT60B1/4 | .591(15.0) | .579(14.7) | .394(10.0) | .079(2.01) | .394(10.0) | .472(11.9) |
| 8-1437624-7 | PKNT70B1/4 | .787(19.9) | .764(19.4) | .571(14.5) | .098(2.49) | .492(12.5) | .591(14.7) |
| 8-1437624-8 | PKNT90B1/4 | .984(25.0) | .957(24.3) | .748(19.0) | .098(2.49) | .591(15.0) | .689(17.5) |

PKN SERIES



PKN60B1/8



| Line Indicator on Natural Aluminum Spin Cap | | | | | | | |
|---|------------|------------|------------|------------|------------|------------|------------|
| Tyco | | | | | | | |
| Electronics | Alcoswitch | A | B | C | D | E | F |
| 8-1437624-2 | PKN60B1/8 | .591(15.0) | .579(14.7) | .394(10.0) | .079(2.01) | .394(10.0) | .453(11.5) |
| | PKN60B1/4 | .591(15.0) | .579(14.7) | .394(10.0) | .079(2.01) | .394(10.0) | .453(11.5) |
| 8-1437624-3 | PKN70B1/4 | .787(20.0) | .764(19.4) | .571(14.5) | .098(2.49) | .492(12.5) | .591(15.0) |
| 8-1437624-4 | PKN90B1/4 | .984(25.0) | .957(24.3) | .748(19.0) | .098(2.49) | .591(15.0) | .689(17.5) |

K

P Series

Knobs, Molded Phenolic

PKS SERIES



PKS1104B1/4

| | | Straight Knurl with Indicator Line on Skirt | | | | | |
|------------------|-------------|---|------------|------------|------------|-------------|------------|
| Tyco Electronics | Alcoswitch | A | B | C | D | E | F |
| 9-1437624-5 | PKS1104B1/4 | 1.12(28.5) | .567(14.4) | .620(15.8) | .090(2.29) | .510(12.95) | .670(17.0) |

PKS SERIES

| | | Straight Knurl Aluminum Skirt Has Line or 0-9 Numbers | | | | | | |
|------------------|---------------|---|------------|------------|------------|------------|------------|---------|
| Tyco Electronics | Alcoswitch | A | B | C | D | E | F | Marking |
| 9-1437624-4 | PKS1103B101/4 | 1.17(29.6) | .571(14.5) | .620(15.7) | .098(2.49) | .516(13.1) | .670(17.0) | Numbers |
| 9-1437624-7 | PKS1106B1/4 | 1.17(29.6) | .571(14.5) | .618(15.7) | .098(2.49) | .516(13.1) | .670(17.0) | Line |
| 9-1437624-6 | PKS1105B101/4 | 1.17(29.6) | .571(14.5) | .618(15.7) | .098(2.49) | .516(13.1) | .670(17.0) | Numbers |



PKS1106B1/4



PKS1103B101/4



PKS1105B101/4



PKS SERIES

SPUN ALUMINUM INLAY



0-10



+5-5



0-9



Indicator Line



PKS1132B51/4

| | | Choice of Indicator Line or 0-9, 0-10, -5+5 Numerals | | | | | | |
|------------------|---------------|--|------------|------------|------------|-------------|------------|----------------|
| Tyco Electronics | Alcoswitch | A | B | C | D | E | F | Marking |
| 1437625-1 | PKS1132B51/4 | 1.18(30.0) | .551(14.0) | .551(14.0) | .118(30.0) | .615(15.62) | .748(19.0) | +5-0-5 |
| 1437625-2 | PKS1132B91/4 | 1.18(30.0) | .551(14.0) | .551(14.0) | .118(30.0) | .615(15.62) | .748(19.0) | 0-9 |
| 9-1437624-9 | PKS1132B101/4 | 1.18(30.0) | .551(14.0) | .551(14.0) | .118(30.0) | .615(15.62) | .748(19.0) | 0-10 |
| 9-1437624-8 | *PKS1132B1/4 | 1.18(30.0) | .551(14.0) | .551(14.0) | .118(30.0) | .615(15.62) | .748(19.0) | Indicator Line |

*1 Set screw 180° from indicator line.



PKS1132B91/4

Knobs, Molded Phenolic

PKS SERIES



PKS90B1/4



PKS90B101/4



| Tyco Straight Knurl with Aluminum Skirt Choice of Arrow or 1-10 Numbers | | | | | | | | | |
|---|-------------|------------|------------|------------|------------|------------|------------|---------|--|
| Electronics | Alcoswitch | A | B | C | D | E | F | Marking | |
| 1437625-5 | PKS90B1/4 | 1.42(36.1) | .917(23.3) | .780(19.8) | .065(1.65) | .490(12.5) | .596(15.1) | Arrow | |
| 1437625-6 | PKS90B101/4 | 1.42(36.1) | .917(23.3) | .780(19.8) | .065(1.65) | .490(12.5) | .596(15.1) | Numbers | |

PKX SERIES



PKX50B1/8



(1) 6-32 SET SCREW EXCEPT PKX-50B, (1) 4-40

| Tyco Ribbed Body, Matte Finish with White Square Indicator on Top | | | | | | | |
|---|------------|------------|------------|------------|------------|-------------|------------|
| Electronics | Alcoswitch | A | B | C | D | E | F |
| 1-1437625-5 | PKX50B1/8 | .590(15.0) | .472(12.0) | .374(9.49) | .059(1.50) | .463(11.76) | .551(14.0) |
| 1-1437625-4 | PKX50B1/4 | .590(15.0) | .472(12.0) | .374(9.49) | .059(1.50) | .463(11.76) | .551(14.0) |
| 1-1437625-7 | PKX60B1/8 | .787(20.0) | .625(15.9) | .472(12.0) | .078(1.98) | .510(13.0) | .598(15.2) |
| 1-1437625-6 | PKX60B1/4 | .787(20.0) | .625(15.9) | .472(12.0) | .078(1.98) | .510(13.0) | .598(15.2) |

PKX SERIES



PKX110B1/4



| Tyco Ribbed Body, Matte Finish with White Square Indicator on Top | | | | | | | |
|---|------------|------------|--------------|-------------|------------|-------------|-------------|
| Electronics | Alcoswitch | A | B | C | D | E | F |
| 1-1437625-1 | PKX100B1/4 | 1.17(29.7) | .970(24.6) | .780(19.81) | .114(2.90) | .570(14.48) | .674(17.12) |
| 1-1437625-2 | PKX110B1/4 | 1.37(34.8) | 1.120(28.45) | .940(23.88) | .100(2.54) | .527(13.38) | .705(17.91) |
| 1-1437625-3 | PKX130B1/4 | 1.57(40.0) | 1.308(33.22) | 1.09(27.6) | .118(3.00) | .623(15.82) | .750(19.05) |

K

P Series

Knob Accessories

ACCESSORIES

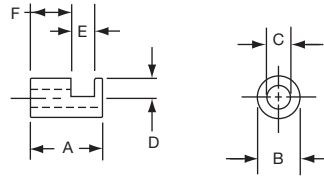

KR1

| Tyco | | Shaft Hole Size Adaptors | | | | | |
|-------------|-------------------|--------------------------|------------|------------|------------|------------|------------|
| Electronics | Alcoswitch | A | B | C | D | E | F |
| 9-1437627-6 | KR1 (1/4"TO1/8") | .374(9.50) | .250(6.35) | .128(3.25) | .122(3.10) | .217(5.51) | .122(3.10) |
| 9-1437627-7 | KR2 (1/4"TO3/16") | .375(9.53) | .250(6.35) | .190(4.83) | .122(3.10) | .216(5.49) | .123(3.12) |
| 9-1437627-8 | KR3 (1/4"TO4MM) | .375(9.53) | .248(6.30) | .161(4.09) | .122(3.10) | .216(5.49) | .123(3.12) |

Компания «Океан Электроники» предлагает заключение долгосрочных отношений при поставках импортных электронных компонентов на взаимовыгодных условиях!

Наши преимущества:

- Поставка оригинальных импортных электронных компонентов напрямую с производств Америки, Европы и Азии, а так же с крупнейших складов мира;
- Широкая линейка поставок активных и пассивных импортных электронных компонентов (более 30 млн. наименований);
- Поставка сложных, дефицитных, либо снятых с производства позиций;
- Оперативные сроки поставки под заказ (от 5 рабочих дней);
- Экспресс доставка в любую точку России;
- Помощь Конструкторского Отдела и консультации квалифицированных инженеров;
- Техническая поддержка проекта, помощь в подборе аналогов, поставка прототипов;
- Поставка электронных компонентов под контролем ВП;
- Система менеджмента качества сертифицирована по Международному стандарту ISO 9001;
- При необходимости вся продукция военного и аэрокосмического назначения проходит испытания и сертификацию в лаборатории (по согласованию с заказчиком);
- Поставка специализированных компонентов военного и аэрокосмического уровня качества (Xilinx, Altera, Analog Devices, Intersil, Interpoint, Microsemi, Actel, Aeroflex, Peregrine, VPT, Syfer, Eurofarad, Texas Instruments, MS Kennedy, Miteq, Cobham, E2V, MA-COM, Hittite, Mini-Circuits, General Dynamics и др.);

Компания «Океан Электроники» является официальным дистрибьютором и эксклюзивным представителем в России одного из крупнейших производителей разъемов военного и аэрокосмического назначения «JONHON», а так же официальным дистрибьютором и эксклюзивным представителем в России производителя высокотехнологичных и надежных решений для передачи СВЧ сигналов «FORSTAR».



JONHON

«JONHON» (основан в 1970 г.)

Разъемы специального, военного и аэрокосмического назначения:

(Применяются в военной, авиационной, аэрокосмической, морской, железнодорожной, горно- и нефтедобывающей отраслях промышленности)

«FORSTAR» (основан в 1998 г.)

ВЧ соединители, коаксиальные кабели, кабельные сборки и микроволновые компоненты:

(Применяются в телекоммуникациях гражданского и специального назначения, в средствах связи, РЛС, а так же военной, авиационной и аэрокосмической отраслях промышленности).



Телефон: 8 (812) 309-75-97 (многоканальный)

Факс: 8 (812) 320-03-32

Электронная почта: ocean@oceanchips.ru

Web: <http://oceanchips.ru/>

Адрес: 198099, г. Санкт-Петербург, ул. Калинина, д. 2, корп. 4, лит. А