



# THERMOMARK LINE

The easy way of printing

# PHOENIX CONTACT – In dialog with customers and partners worldwide

Phoenix Contact is one of the leading manufacturers of electrical connection and industrial automation technology.

Founded over 80 years ago, the company now employs 9900 people all over the world, more than 5500 of whom are based in Germany. A sales network with over 46 subsidiaries and more than 30 additional sales partners guarantees customer proximity directly on site, anywhere in the world.

The product range comprises first-class components, systems and services for a wide range of applications – the offer ranges right from modular terminal blocks to interface technology, PCB connection methods, solutions for surge protection all the way to hardware and software solutions for the automation of industrial systems.



## Global player with personal customer contact

Company independence is an integral part of our corporate policy. Phoenix Contact therefore relies on in-house competence and expertise in a range of contexts: the design and development departments constantly come up with innovative product ideas, developing special solutions to meet customer requirements. Numerous patents emphasize the fact that many products are own-grown Phoenix Contact developments.

## THERMOMARK LINE

THERMOMARK LINE from Phoenix Contact is the intelligent solution for the quick and easy labeling of terminal blocks, conductors and devices. The system comprises two different thermal transfer printers, the THERMOMARK CARD and the THERMOMARK ROLL, a high-quality notebook with pre-installed CLIP PROJECT planning and marking software and a wide range of marking materials in card, sheet and roll format.



### Table of contents

#### **THERMOMARK LINE –**

a seamless system from planning through to the finished printed application

Page 4

---

#### **THERMOMARK LINE –**

marking expertise

Page 10

---

#### **THERMOMARK CARD –**

labeling material in card and sheet format for terminal block, conductor and device marking

Page 18

---

#### **THERMOMARK ROLL –**

labeling material in roll and continuous format for terminal block, conductor and device marking

Page 26

---

#### **Marker carriers for terminal block, conductor and device marking**

Page 36

---

#### **Matrix –**

assignment of the marking material to the individual terminal blocks and devices from Phoenix Contact and other manufacturers

Page 42

---

#### **Register**

Page 64

---

# THERMOMARK LINE –

a seamless system from planning through to the finished printed application



Software



Printer

THERMOMARK LINE - software and hardware made to match for quick and easy labeling of your applications. A wide range of software-controlled terminal block, conductor and device marking materials are available for the labeling of your entire application, irrespective of which printer system you opt for.

## THERMOMARK CARD



## THERMOMARK ROLL



## Marker carriers



## Matrix

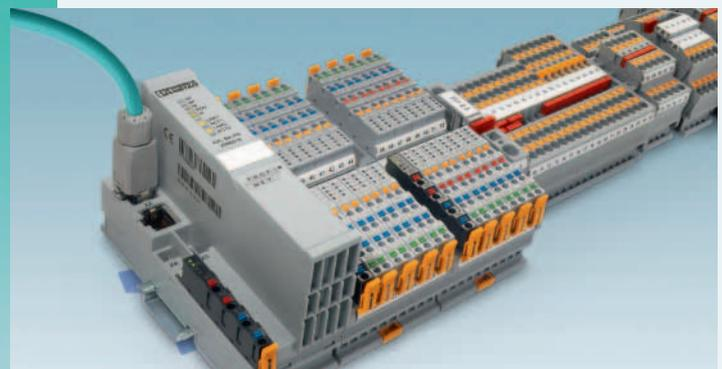

Material

## THERMOMARK CARD

This thermal transfer printer prints marking materials in card and sheet format. You can mark your terminal blocks, conductors and devices easily and to a high quality. The low weight and compact design of the printer also allow for mobile use on-site.



Technical data	Description	Type	Order No.
Print resolution 300 dpi Speed 8 sec/sheet Interfaces USB and Ethernet Power supply 100 - 240 V ~ 50/60Hz, PFC Operation Touch screen Printable material Plastic sheets, UCT and US format Dimensions (W x H x D) 253 x 189 x 320 mm Weight approx. 6 kg	<b>THERMOMARK CARD</b> , thermal transfer printer for card and sheet material, incl. Euro mains cable, US mains cable, USB cable, CLIP PROJECT advanced software, CD with multi-language usermanual, driver and firmware, DIN A5 manual German/English, magazine for UCT-TM materials, magazine for US materials, one UCT-TM 5, one US-EMP (85.6 x 54), one ink ribbon (50-meter sample roll)	THERMOMARK CARD	<b>5146464</b>
	<b>THERMOMARK CARD SET</b> , consisting of THERMOMARK CARD and MARKING NOTEBOOK with German keyboard and the CLIP PROJECT professional software	THERMOMARK CARD SET	<b>5147200</b>
	<b>THERMOMARK CARD SET EN</b> , consisting of THERMOMARK CARD and MARKING NOTEBOOK with English keyboard and the CLIP PROJECT professional software	THERMOMARK CARD SET EN	<b>5147201</b>
THERMOMARK CARD accessories	Description	Type	Order No.
	Magazine for US cards	THERMOMARK CARD - US-MAG1	<b>5146451</b>
	Magazine for UCT sheets [UCT-TM..., UCT1-TM..., UCT5-TM...]	THERMOMARK CARD - UCT-MAG1	<b>5146480</b>
	Magazine for UCT sheets [UCT-TMF...]	THERMOMARK CARD - UCT-MAG2	<b>5146563</b>
	Magazine for UCT sheets [UCT-WMS...]	THERMOMARK CARD - UCT-MAG3	<b>5146613</b>
	Magazine for UCT sheets [UCT1-TMF...]	THERMOMARK CARD - UCT-MAG4	<b>5146614</b>
	Magazine for UCT sheets [UCT2-TM...]	THERMOMARK CARD - UCT-MAG5	<b>5146615</b>
	Magazine for UCT sheets [UCT3-TM...]	THERMOMARK CARD - UCT-MAG6	<b>5146616</b>
	Ink ribbon, ink color: black, length 300 m, width 110 mm	THERMOMARK-RIBBON 110-TC	<b>080137 1</b>
	Stable transport case with aluminum edges for printers and accessories	TL CASE	<b>0800613</b>

## THERMOMARK ROLL

This thermal transfer printer has been designed for printing rolls and continuous media. You can easily create accurately printed labels, markers and shrink sleeves for terminal block, conductor and device marking. The compact printer is also suitable for mobile use.



Technical data		Description	Type	Order No.
Print resolution	300 dpi	<b>THERMOMARK ROLL</b> , thermal transfer-printer for roll material, incl. Euro mains cable, US mains cable, USB cable, CLIP PROJECT advanced software, CD with multi-language user manual, driver and firmware, DIN A5 manual German/English, one roll of labels EML (20x8) with 1000 labels, one ink ribbon (50-meter sample roll)	THERMOMARK ROLL	<b>5146477</b>
Interfaces	USB and Ethernet			
Power supply	100 - 240 V ~ 50/60Hz, PFC			
Operation	Touch screen			
Printable material	Labels and shrink sleeve in roll format			
Dimensions (W x H x D)	253 x 189 x 320 mm	<b>THERMOMARK ROLL SET</b> , consisting of THERMOMARK ROLL and MARKING NOTEBOOK with German keyboard and the CLIP PROJECT professional software	THERMOMARK ROLL SET	<b>5147300</b>
Weight	approx. 3.5 kg	<b>THERMOMARK ROLL SET EN</b> , consisting of THERMOMARK ROLL and MARKING NOTEBOOK with English keyboard and the CLIP PROJECT professional software	THERMOMARK ROLL SET EN	<b>5147301</b>
THERMOMARK ROLL accessories		Description	Type	Order No.
		External media hub, for rolls of 150 to 305 mm outside diameter (RL rolls)	THERMOMARK ROLL-ERH	<b>5146448</b>
		External media hub, for rolls of up to 500 mm outside diameter (RXL rolls)	THERMOMARK-ERH 500	<b>5146309</b>
		Cutter, can be assembled later, for cutting continuous media precisely to length	THERMOMARK ROLL-CUTTER	<b>5146422</b>
		Perforation device, can be assembled later, for perforating continuous media	THERMOMARK ROLL-CUTTER/P	<b>5146435</b>
		Ink ribbon, ink color: black, length 300 m, width 110 mm	THERMOMARK-RIBBON 110	<b>5145384</b>
		Ink ribbon, ink color: blue, length 300 m, width 110 mm	THERMOMARK-RIBBON 110 BU	<b>0829544</b>
		Ink ribbon, ink color: green, length 300 m, width 110 mm	THERMOMARK-RIBBON 110 GN	<b>0829542</b>
		Ink ribbon, ink color: red, length 300 m, width 110 mm	THERMOMARK-RIBBON 110 RD	<b>0829543</b>
		Ink ribbon, ink color: black, length 300 m, width 110 mm, for high-temperature labels	THERMOMARK-RIBBON 110-EMLHT	<b>0800342</b>
		Ink ribbon for labeling shrink sleeves, ink color: black, length 300 m, width 110 mm	THERMOMARK-RIBBON 110-WMSU	<b>0801358</b>
		Ink ribbon for labeling shrink sleeves, ink color: white, length 300 m, width 110 mm	THERMOMARK-RIBBON 110-WMSU WH	<b>0801359</b>
		Stable transport case with aluminum edges for printers and accessories	TL CASE	<b>0800613</b>

## CLIP PROJECT software and MARKING NOTEBOOK

### CLIP PROJECT...

The high-performance planning and marking software enables quick configuration and labeling for the control cabinet and in the field. With the click of a mouse, the software retrieves all data from electrical planning systems and automatically places the correct products and their markings in graphics and parts lists. CLIP PROJECT... supports all output devices from Phoenix Contact and, thanks to automatic Internet updates, is always up-to-date.



Technical data		Description	Type	Order No.
CPU	Pentium II > 400 MHz	<b>CLIP PROJECT advanced</b> , planning and marking software in German, English, French, Italian, Spanish, Russian, Polish, Hungarian, Czech, Portuguese, Chinese  Software is included in the scope of supply of the THERMOMARK CARD and THERMOMARK ROLL.	CLIP PROJECT ADVANCED	<b>5146040</b>
Main memory/	128 MB/2GB			
hard disk space	CD-ROM			
Drive	1024x768			
Monitor resolution	Mouse recommended			
Operating equipment	Windows Vista	<b>CLIP PROJECT professional</b> , extended version of CLIP PROJECT advanced with additional template designer, for designing your own marking material.  Software is included in the scope of supply of the MARKING BOX and is pre-installed on the MARKING Notebook.	CLIP PROJECT PROFESSIONAL	<b>5146053</b>
Operating systems	Windows XP			
	Windows 7			

## MARKING BOX

### MARKING BOX...

This is the complete labeling system for all applications in terminal block, conductor and device marking.

The box contains the THERMOMARK CARD and THERMOMARK ROLL thermal transfer printers, plus a high-performance notebook with the CLIP PROJECT professional planning and marking software pre-installed. The system guarantees quick startup without the need for installation or configuration work (Plug'n'Print).



Description	Type	Order No.
<b>MARKING BOX</b> , consisting of the THERMOMARK CARD and THERMOMARK ROLL printers, plus the MARKING NOTEBOOK with German keyboard	MARKING BOX	5147100
<b>MARKING BOX EN</b> , consisting of the THERMOMARK CARD and THERMOMARK ROLL printers, plus the MARKING NOTEBOOK with English keyboard	MARKING BOX EN	5147101
<b>THERMOMARK CARD SET</b> , consisting of THERMOMARK CARD and MARKING NOTEBOOK with German keyboard	THERMOMARK CARD SET	5147200
<b>THERMOMARK CARD SET EN</b> , consisting of THERMOMARK CARD and MARKING NOTEBOOK with English keyboard	THERMOMARK CARD SET EN	5147201
<b>THERMOMARK ROLL SET</b> , consisting of THERMOMARK ROLL and MARKING NOTEBOOK with German keyboard	THERMOMARK ROLL SET	5147300
<b>THERMOMARK ROLL SET EN</b> , consisting of THERMOMARK ROLL and MARKING NOTEBOOK with English keyboard	THERMOMARK ROLL SET EN	5147301

### MARKING NOTEBOOK

The notebook from the Dell Latitude TM E range transforms the new THERMOMARK printers into a complete marking system. It is characterized by reliability, a long service life and a professional design. Windows 7, CLIP PROJECT professional marking software and all of the required drivers are pre-installed and guarantee a quick startup of the entire system. Simply connect the notebook and printer via USB and you're done (Plug'n'Print).



Technical data		
Processor	One Intel®Core TM i3	The information describes the configuration at the time of going to print. Subject to modifications in the interest of technical progress or product improvements.
Display	14" WXGA widescreen	
Hard disk	160 GB with 5,400 rpm (serial ATA)	
Main memory	DDR 3 with 2 GB and 1333 MHz	
Battery	Li-ION battery with 37 Wh	

# THERMOMARK LINE – marking expertise

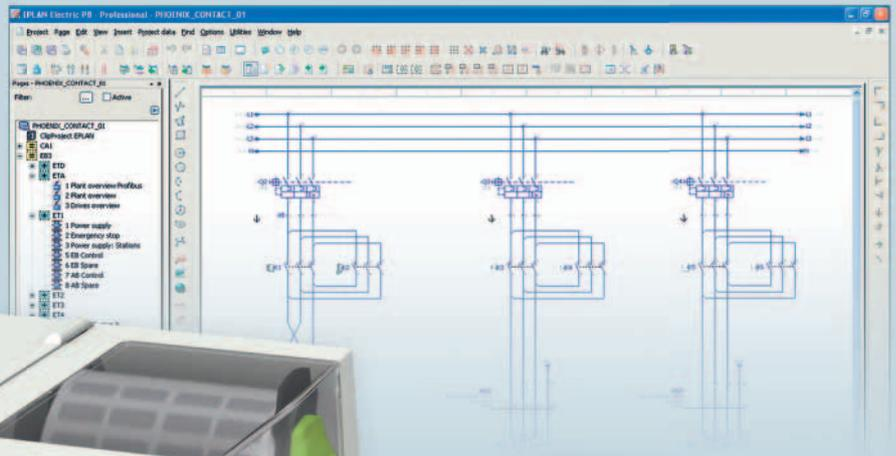

## Test procedure for marking material in accordance with recognized standards

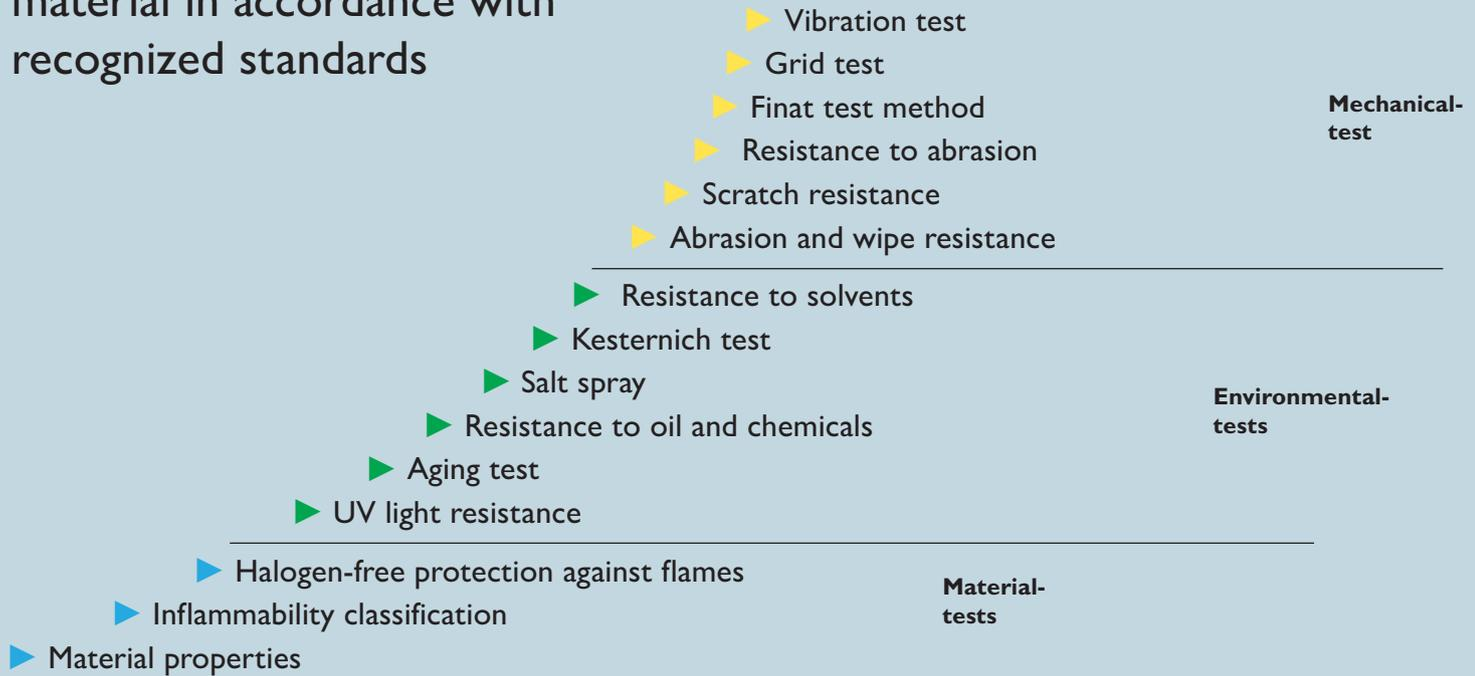

## Material properties

### Polyamide (PA)

Even at high operating temperatures, polyamide has excellent electrical, mechanical, chemical and thermal properties. Brief peak temperatures of up to 200°C are permissible as a result of heat aging stabilization. Polyamide absorbs moisture from its surroundings, on average 2.8%. However, this moisture is not crystallization water in the plastic itself, but chemically bonded H<sub>2</sub>O groups in the molecular structure. This makes the plastic flexible and resistant to breakage, even at temperatures as low as -60°C. PA belongs to inflammability class V2 to V0 as per UL 94. Polyamide, used by Phoenix Contact, is silicone- and halogen-free and is suitable for use in temperatures between -60°C and +125°C.

### Polycarbonate (PC)

Polycarbonate has a high mechanical strength and chemical resistance. Rigidity, dimensional stability and good heat distortion resistance are further distinguishing features of this material. Polycarbonate is used to manufacture particularly smooth and stable marking materials. Polycarbonate, used by Phoenix

Contact, absorbs little moisture, is silicone- and halogen-free and is suitable for use in temperatures between -40°C and +125°C.

### Polyvinyl chloride (PVC)

PVC has a long service life. It is characterized by its high mechanical strength and chemical resistance. Neither oxygen nor ozone affects PVC. The material is resistant to corrosive salt solutions and most acids. Polyvinyl chloride, used by Phoenix Contact, is silicone-free and is suitable for use in temperatures between -30°C and +80°C.

### Polyester

Polyester is a chemical-resistant material. It is ideally suited to printing, shaping and punching. Polyester is resistant to UV radiation and absorbs little moisture. Polyester, used by Phoenix Contact, is silicone- and halogen-free. Depending on its composition, it is suitable for use in temperatures between -40°C and +150°C.

### Polyolefins

Polyolefins are semi-crystalline thermoplastics, which can be easily processed as extrusion profiles (shrink sleeves).

They are characterized by good chemical resistance. Silicone-free, temperature range: -55°C to +125°C.

### Polyethylene (PE)

Polyethylene is a thermoplastic material which is highly resistant to acids, alkalis and other solvents. PE absorbs hardly any moisture and has a high durability and breaking elongation. Silicone- and halogen-free, temperature range: -40°C to +80°C.

### Halogen-free

The term halogen-free, based on international standards for the basic materials for PCBs (e.g. IEC 61249-2-21, IPC 4101 C), relates to the elements chlorine and bromine in flame protection agents. This also forbids the use of flame protection agents containing halogen in accordance with DIN EN ISO 1043-4. This means that, according to the definition in the ZVEI position paper (requirements for the use of halogen-free products in the electrical and electronics industry), no flame protection agents containing halogen or PVC are present in the components.

## Inflammability classification

### ► UL 94

UL 94 describes inflammability tests that have gained particular importance in the field of electrotechnology. Behavior in fire is the main focus. Items are classified according to either UL 94 HB (Horizontal Burn) or UL 94 V (Vertical Burn). The test setup is such that the 94 V0/1/2 classifications are stricter than the 94 HB classification.

#### UL 94 V0/1/2

After conditioning, the test bar is vertically clamped and flame-treated several times for 10 seconds each.

Between the flame treatments, the time until the test bar is extinguished is measured. The afterglow time and dripping properties are then assessed.

The performance of the test as per this standard is not suitable for foils and/or very thin test objects that shrink under the thermal aging of the flame.

The plastic used for Phoenix Contact products fulfills the higher-grade criteria.

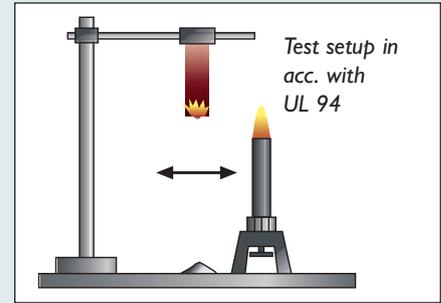

#### Classification

	UL 94 V0	UL 94 V1	UL 94 V2	UL 94 HB
Burning time after each flame treatment	≤ 10 s	≤ 30 s	≤ 30 s	–
Total burning time after 10 flame treatments	≤ 50 s	≤ 250 s	≤ 250 s	–
Glowing time after the 2nd flame treatment	≤ 30 s	≤ 60 s	≤ 60 s	–
Complete burn-off	No	No	No	Yes
Inflammation of the absorbent cotton under the sample	No	No	Yes	–

## Halogen-free protection against flames

### ► DIN EN ISO 1043-4

Halogens are the chemical elements astatine, fluorine, chlorine, bromine and iodine. One characteristic of the halogen compounds of bromine and chlorine relates to the reduction in the degree of inflammability when plastics are used. In the event of fire, poisonous corrosive gases are formed, which can also lead to secondary damage as a result of the extinguishing water. For this reason, Phoenix Contact does not use any flame protection agents which contain halogen or other additives. Polyamide, polycarbonate, polycarbonate/acrylnitrile butadiene styrene, acrylnitrile butadiene styrene, and polyolefins feature halogen-free flame protection systems.



## UV light resistance

### ► DIN EN ISO 4892-2 and DIN EN ISO 60068-2-5

In addition to infrared radiation, the solar radiation affecting the surface of the earth has radiation ranges from the UV-A and UV-B spectrum. Depending on the plastic used, the UV-B part of the wavelength of 320 nm induces a more or less strong molecular decomposition that is responsible for a considerable restriction of the plastic's mechanical property profile. Even the properties of printings and labelings can undergo damage to a greater or lesser extent due to this UV radiation, resulting in fading which can even lead to complete illegibility.

If plastics and their printings and labelings are often subjected to day/night cycles outdoors, condensation may appear on the surface in the form of water droplets, which can act similarly to magnifying glasses when the sunshine returns, thus intensifying the radiation effect. The UV-B part of the solar spectrum in particular

leads to an impairment of the plastic's mechanical property profile.

Marking materials from Phoenix Contact can be stored in dry as well as humid atmospheres under UV radiation and are tested in accordance with the aforementioned standards. The properties of the plastic and the legibility of the printings and labelings are checked after the test.



## Aging test

### ► IEC 60947-7-1/-2

Modular terminal blocks are characterized, among other things, by long life cycles and their ability to safely withstand continuous temperatures of +125°C. In order to ensure that the labeling of these terminal blocks also meets these requirements, Phoenix Contact uses labeling materials with heat stabilizers.

To simulate usage over several years, the marking materials are subjected to temperature cycles together with the terminal blocks or conductors in the climate cabinet. The minimum temperature in the climate cabinet is set to 20°C and the maximum temperature to 120°C (80°C with PVC). The test objects reach the maximum permissible operating temperature during the warming phase and the 10-minute pause phase. The cooling down phase follows. The test comprises a total of 192 cycles.

Phoenix Contact marking materials are, without exception, tested in accordance with IEC 60947-7-1/-2. All plastics used also have sufficient safety reserves.

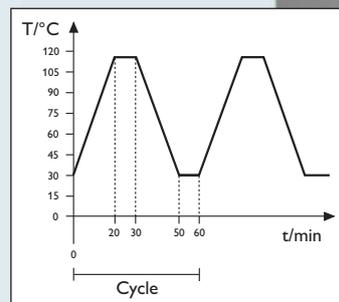

Temperature in relation to time

## Resistance to oil and chemicals

### ► DIN EN ISO 175

Physical and/or chemical processes/reactions can occur as a result of external media, such as liquids or gases. This can result in a change to the plastic's properties, the plastic becoming damaged or even destroyed. The printings and labelings can also be affected by these changes.

In order to prevent this from happening, Phoenix Contact uses only plastics and printing/labeling materials which have been tested in accordance with DIN EN ISO 175.



Chemical	Weight %
<b>Alkalis</b>	
Sodium hydroxide solution	3
Potassium hydroxide solution	3
Ammonium hydroxide (ammonia water)	25
<b>Alcohols</b>	
Ethanol	100
1-propanol	100
2-propanol	100
Diethylene glycol	100
<b>Aldehyde/ketones</b>	
Ethyl acetate	100
<b>Oils, greases, aliphatic and aromatic hydrocarbons</b>	
IRM 902	100
IRM 903	100
ASTM No. 1	100
Xylol	100
Test benzene (180/220)	100
Hycut SU 68	100
Hycut SET 46	100
Shell Tellus 92	100
<b>Aqueous salt solutions</b>	
Sodium chloride	5
Potassium chloride	5
Ammonium chloride (ammonia solution)	100

## Resistance to solvents

### ► EN 60464-2:2001

Printings and labelings must be resistant to solvent vapors. Therefore, in accordance with the aforementioned standard, exposure to solvents is continued over 10 days in the following atmospheres:

- Acetone
- n-hexane
- Ethanol

The labelings and printings must still be legible after the 10-day exposure.

Phoenix Contact marking materials are solvent-resistant and fulfill the stringent requirements.



## Corrosion test

### ► DIN 50018

Extreme ambient influences impose demanding requirements on components and their labeling and marking.

The following test method, based on DIN 50018, describes the corrosion test in an alternating condensation climate with an atmosphere that contains sulphur dioxide.

Two liters of distilled water and one liter of SO<sub>2</sub> gas are introduced into a climate cabinet. During the test and at a test temperature of 40°C, an acidic atmosphere is formed, which affects the material surfaces of the test objects. After eight hours of testing, the test objects dry for 16 hours with an open door. A microscopic visual check is finally performed.

All marking materials used by Phoenix Contact comply with this demanding standard and are resistant to aggressive media.



## Salt spray

### ► IEC 60068-2-11/-52

Particularly in shipbuilding, technical components have to be marked and must remain permanently legible in corrosive atmospheres. The salt content of the air in combination with the increased humidity places high demands on the labelings and materials used. On the basis of IEC 60068-2-11/-52, it is possible to simulate the influence of a sea climate.

The resistance of the materials in a corrosive atmosphere is tested using salt spray. The test objects are placed in the test chamber and subjected to a finely dosed spray of 5% sodium chloride solution (NaCl; pH-value 6.5 - 7.2) at a temperature of +35°C for a period of 96 hours. A microscopic inspection is performed after the test. In IEC 60068-2-52, testing is also performed using 5% sodium chloride, but under conditions with different specifications.

Phoenix Contact marking materials fulfill these stringent requirements and can be used even in extreme climatic conditions.

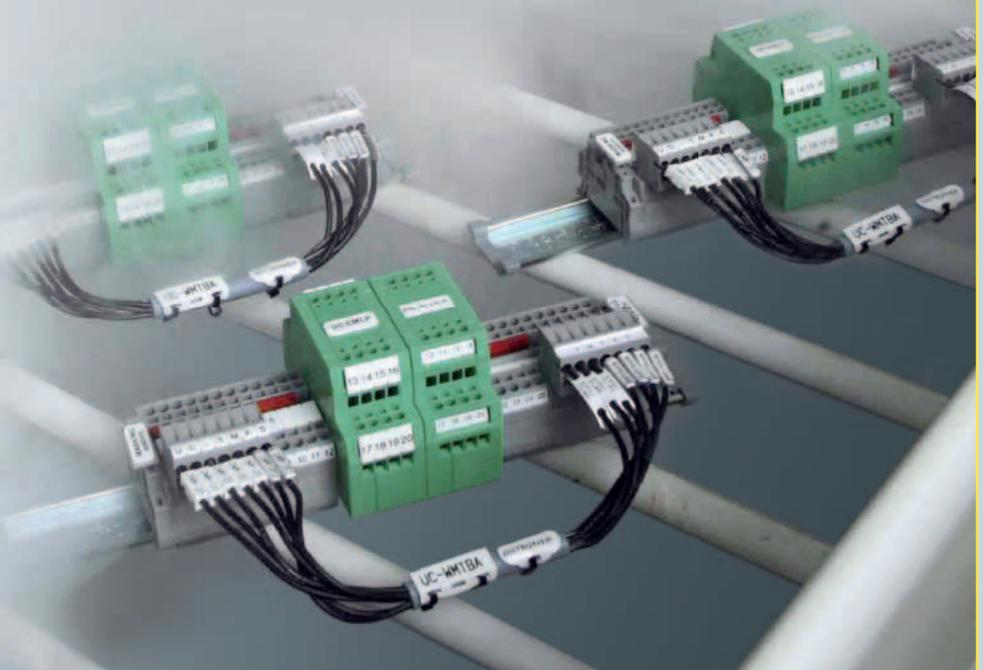

## Scratch resistance

### ► DIN EN ISO 1518

Labelings and printings must also be resistant to external, point and/or linear mechanical loads. For this reason, Phoenix Contact tests all labelings and printings for scratch resistance in accordance with the aforementioned standard. Here a scratching tool with a hemispherical tip ( $\varnothing 1 \text{ mm}$ ) is applied to the test object with 2 - 6 N, depending on the printing procedure. A visual and microscopic inspection of the test objects is then performed.

Phoenix Contact marking materials fulfill these demanding mechanical requirements.



## Grid test

### ► DIN EN ISO 2409

A "Sellotape test" is conducted in accordance with this standard. A transparent self-adhesive tape (e.g. Sellotape) with an adhesive force of  $10 \pm 1 \text{ N}$  is applied to the labeling or printing to be tested and is then removed from the surface with an angle of  $60^\circ$  to the pull-out direction with a speed of approx. 1 cm/s.

There should be no marks from the printing on the adhesive tape after the test.

Phoenix Contact marking materials are tough and resistant to peeling.

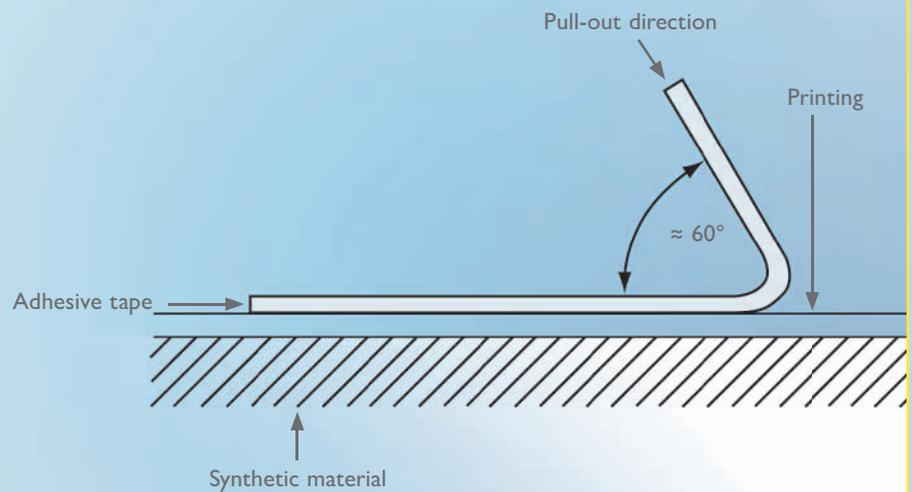

## Adhesive strength test

### ► based on FINAT test method No. 2

The purpose of this test is to compare the adhesive strength of labels on various basic materials. To this end, a strip of labels (25 mm x 175 mm) is applied to the respective basic material with a specified force. After a defined storage period, the strip is removed from the basic material at

an angle of  $90^\circ$  and with a speed of 300 mm/min. The adhesive strength is specified in N/25 mm. The test thus enables the selection of the most suitable label for the application.

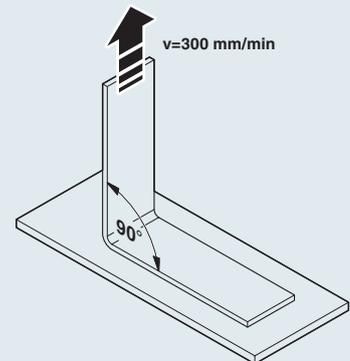

## Resistance to abrasion

### ► KIMW 003, Part 1 In-house standard of the Lüdenscheid Plastics Institute

Labelings and printings must be resistant to externally applied surface loads. Therefore at Phoenix Contact, labelings and printings are subjected to various numbers of strokes (1000, 10,000, 30,000) using a felt disk (hardness H1 as per

DIN 61200) with a specific pressure force (1 N, 2 N and/or 4 N). Classification into the various load classes presented in the standard depends on the pressure force that leads to damage to the printing with reference to the number of strokes.

The printings and labelings at Phoenix Contact fulfill the highest load class K9 (30,000 strokes with 4 N pressure force).

## Abrasion and wipe resistance

### ► DIN EN 61010-1

Labelings and printings must be resistant to the standard cleaning agents used in the industry. Therefore at Phoenix Contact, the labelings and printings are rubbed using a soft cloth with water, isopropyl alcohol, petroleum ether and n-hexane. The labelings and printings must still be legible after the test.

Phoenix Contact marking materials fulfill the stringent requirements as regards abrasion and wipe resistance and can thus be used in all applications.



## Vibration test

### ► DIN EN 61373 – Broadband noise (intensity as per DIN EN 50155)

In many applications and especially in traffic engineering, labeling materials are subjected to vibrations and shocks. For a practical simulation of the vibration stress, the test objects are tested for vibration resistance at increasing and decreasing frequencies and amplitudes. In accordance

with DIN EN 61373, the objects run through a frequency range of 5 Hz to 150 Hz during the test. The true r.m.s. value of the acceleration is up to 42.5 m/s<sup>2</sup>. The test objects are tested for five hours on each of the three axes (x, y, z). The components and marking materials must not be damaged in

such a way that would impair their continued use.

All Phoenix Contact marking materials fulfill these stringent vibration requirements.

### ► IEC 60068-2-6 – Vibration resistance

This test demonstrates the vibration resistance and the secure seating of the marking materials under the influence of continuous vibrations. Harmonic, sinusoidal vibrations are applied to the test object to simulate rotating, pulsating or oscillating forces. The test is performed on each of the three spatial axes (x, y, z). In the test, the object runs through a frequency range of 5 Hz to 150 Hz at a speed of one octave per minute. The true r.m.s. value of the acceleration is up to 50 m/s<sup>2</sup>. The test objects are tested in the three axes for two hours each. The

marking materials must not be damaged in such a way that would impair their continued use. All marking materials fulfill the requirements of the standard. They are therefore particularly suited to demanding applications in which a reliable functioning of the marking materials has to be ensured, even when subjected to vibrations.

Phoenix Contact marking materials fulfill these stringent vibration requirements.

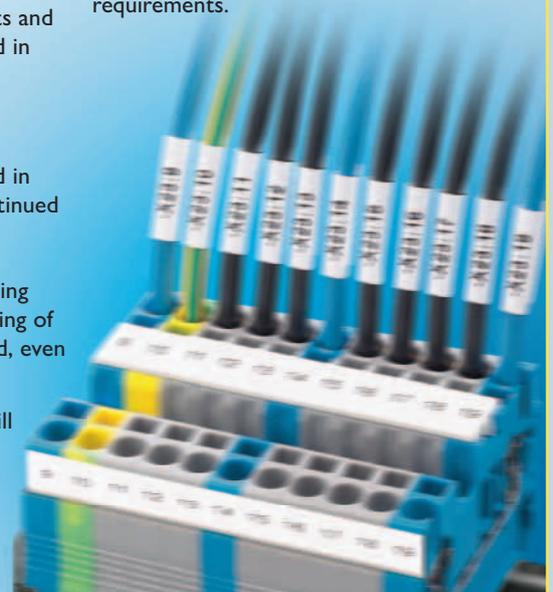

# THERMOMARK CARD –

## The perfect printer for marking materials in card and sheet format

The THERMOMARK CARD uses the tried-and-tested thermal transfer procedure to print plastic markers in UniCard and UniSheet format.

The UniCard format is characterized by:

- simple handling
- simple separation
- simple mounting

The UniSheet format has the following advantages:

- low price
- simple separation

The comprehensive range includes markers for terminal block, conductor and device marking applications.

You can create the perfect labeling quickly and easily with the CLIP PROJECT software.



## Phoenix Contact terminal block marking for high and flat marker grooves

### UniCard UCT-TM.../UCT-TMF...

The UCT-TM... range is ideal for the quick and precise labeling of modular terminal blocks with a high marker groove. The UCT-TMF... markers can be used for modular terminal blocks with a flat marker groove. Both markers are available in all standard pitches and colors.<sup>1) 2)</sup>

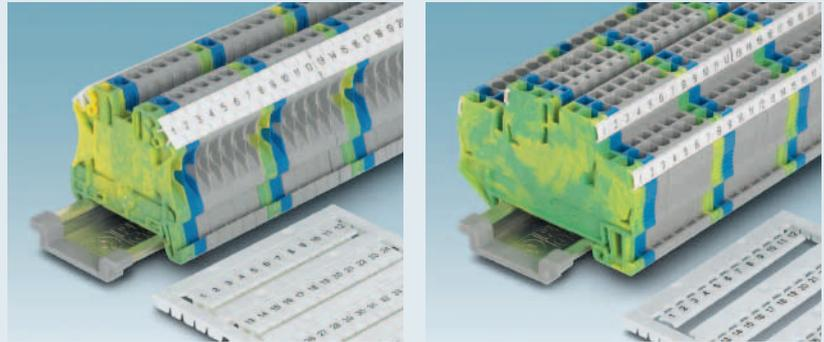

	Terminal block width [mm]	Markers per sheet	Pcs./Pkt.	Type	Order No.
					WH
	3.5	102	10	UCT-TM 3,5	0829484
	4.2	84	10	UCT-TM 4	0828732
	5.2	72	10	UCT-TM 5	0828734
	6.2	60	10	UCT-TM 6	0828736
	7.62	48	10	UCT-TM 7,62	0828738
	8.2	42	10	UCT-TM 8	0828740
	10.2	36	10	UCT-TM 10	0829142
	12	30	10	UCT-TM 12	0829144
	16	18	10	UCT-TM 16	0829146

Terminal block width [mm]	Markers per sheet	Type	Order No.					
			RD	OG	YE	VT	BU	GN
3.5	102	UCT-TM 3,5 ...	0829505	0829506	0829485	0829507	0829508	0829509
4.2	84	UCT-TM 4 ...	0829149	0829150	0828733	0829151	0829152	0829153
5.2	72	UCT-TM 5 ...	0829154	0829155	0828735	0829156	0829157	0829158
6.2	60	UCT-TM 6 ...	0829159	0829160	0828737	0829161	0829162	0829163
7.62	48	UCT-TM 7,62 ...	0829510	0829511	0828739	0829512	0829513	0829514
8.2	42	UCT-TM 8 ...	0829164	0829165	0828741	0829166	0829167	0829168
10.2	36	UCT-TM 10 ...	0829169	0829170	0829143	0829171	0829172	0829173
12	30	UCT-TM 12 ...	0829174	0829175	0829145	0829176	0829177	0829178
16	18	UCT-TM 16 ...	0829179	0829180	0829147	0829181	0829182	0829183

	Terminal block width [mm]	Markers per sheet	Pcs./Pkt.	Type	Order No.
					WH
	3.5	108	10	UCT-TMF 3,5	0829486
	4.2	90	10	UCT-TMF 4	0828742
	5.2	72	10	UCT-TMF 5	0828744
	6.2	60	10	UCT-TMF 6	0828746
	8.2	42	10	UCT-TMF 8	0828748
	10.2	36	10	UCT-TMF 10	0829204
	12	30	10	UCT-TMF 12	0829214
		16	18	10	UCT-TMF 16

Terminal block width [mm]	Markers per sheet	Type	Order No.					
			RD	OG	YE	VT	BU	GN
3.5	108	UCT-TMF 3.5 ...	0829515	0829516	0829487	0829517	0829518	0829519
4.2	90	UCT-TMF 4 ...	0829184	0829185	0828743	0829186	0829187	0829188
5.2	72	UCT-TMF 5 ...	0829189	0829185	0828745	0829191	0829192	0829193
6.2	60	UCT-TMF 6 ...	0829194	0829195	0828747	0829196	0829197	0829198
8.2	42	UCT-TMF 8 ...	0829199	0829200	0828749	0829201	0829202	0829203
10.2	36	UCT-TMF 10 ...	0829205	0829206	0829207	0829208	0829209	0829210
12	30	UCT-TMF 12 ...	0829212	0829213	0829211	0829215	0829216	0829217
16	18	UCT-TMF 16 ...	0829219	0829220	0829221	0829222	0829223	0829224

<sup>1)</sup> In order to label this material you will need a suitable magazine. See page 6.

<sup>2)</sup> For the assignment of these materials to the appropriate products, see page 42 onwards.

## Phoenix Contact terminal block marking for high and flat marker grooves

### UniSheet US-TM.../US-TMF...

US-TMF 100 for the easy and low-cost labeling of modular terminal blocks with high and flat marker grooves. US-TM 100 has been specially designed for the labeling of terminal blocks with universal marker grooves, such as the PIT...<sup>1)</sup>

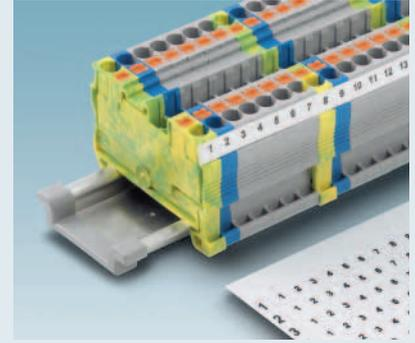
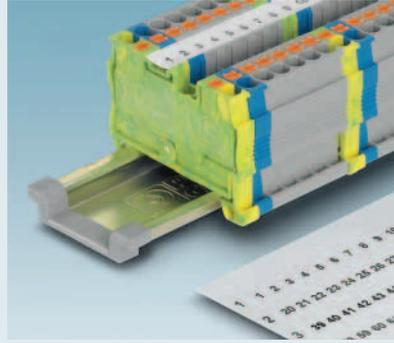

	Material width [mm]	Markers per card	Pcs./Pkt.	Type	Order No.
					WH
	Unperforated 104	13	10	US-TM 100	<b>0829255</b>
	Unperforated 104	20	10	US-TMF 100	<b>0829260</b>

## Terminal block marking for Weidmüller/Conta Clip and Klemsan for high and flat marker grooves

### UniCard UCT1-TM.../UCT1-TMF...

UniCard markers are also available in a variety of common pitches and colors for the individual labeling of modular terminal blocks made by other manufacturers.<sup>1) 2)</sup>



	Terminal block width [mm]	Markers per sheet	Pcs./Pkt.	Type	Order No.
					WH
	5.2	72	10	UCT1-TM 5	<b>0829482</b>
	6.2	60	10	UCT1-TM 6	<b>0829483</b>

Terminal block width [mm]	Markers per sheet	Type	Order No.				
			RD	OG	YE	BU	GN
5.2	72	UCT1-TM 5 ...	<b>0829226</b>	<b>0829227</b>	<b>0829228</b>	<b>0829229</b>	<b>0829230</b>
6.2	60	UCT1-TM 6 ...	<b>0829232</b>	<b>0829233</b>	<b>0829234</b>	<b>0829235</b>	<b>0829236</b>

	Terminal block width [mm]	Markers per sheet	Pcs./Pkt.	Type	Order No.
					WH
	5.2	72	10	UCT1-TMF 5	<b>0829237</b>
	6.2	60	10	UCT1-TMF 6	<b>0829243</b>

Terminal block width [mm]	Markers per sheet	Type	Order No.				
			RD	OG	YE	BU	GN
5.2	72	UCT1-TMF 5 ...	<b>0829238</b>	<b>0829239</b>	<b>0829240</b>	<b>0829241</b>	<b>0829242</b>
6.2	60	UCT1-TMF 6 ...	<b>0829244</b>	<b>0829245</b>	<b>0829246</b>	<b>0829247</b>	<b>0829248</b>

<sup>1)</sup> In order to label this material you will need a suitable magazine. See page 6.

<sup>2)</sup> For the assignment of these materials to the appropriate products, see page 49 onwards.

## Terminal block marking for Wieland/Cabur and Wago for high marker grooves

### UniCard UCT3-TM... and UCT5-TM...

UniCard markers are also available in a variety of common pitches for the individual labeling of modular terminal blocks made by other manufacturers.<sup>1) 2)</sup>



	Terminal block width [mm]	Markers per sheet	Pcs./Pkt.	Type	Order No.
					WH
 Terminal block marking, Wieland	5	72	10	UCT3-TM 5	0829251
	6	60	10	UCT3-TM 6	0829252
	Terminal block width [mm]	Markers per sheet	Pcs./Pkt.	Type	Order No.
					WH
 Terminal block marking, Cabur	5	66	10	UCT5-TM 5	0828750
	6	54	10	UCT5-TM 6	0828752

### UniCard UCT2-TM5/6 and UniSheet US2-TM 100

UniCard and UniSheet markers are also available in a variety of pitches for the individual labeling of modular terminal blocks made by other manufacturers.<sup>1)</sup>



	Terminal block width [mm]	Markers per sheet	Pcs./Pkt.	Type	Order No.
					WH
 Terminal block marking, Wago	5.0 - 6.0	72	10	UCT2-TM5/6	0829249
	Material width [mm]	Markers per card	Pcs./Pkt.	Type	Order No.
					WH
 Terminal block marking, Wago	Unperforated 104	12	10	US2-TM 100	0829268

<sup>1)</sup> In order to label this material you will need a suitable magazine. See page 6.

<sup>2)</sup> For the assignment of these materials to the appropriate products, see page 49 onwards.

## Conductor marking for threading and for insertion into marking collars

### UniCard UCT-WMS... and UniSheet US-WMT...

The UCT-WMS markers are simply threaded onto the conductors and held securely in place by three internal studs. The US-WMT markers have been specially designed for conductor marking with marking collars. The collars protect against environmental influences (see page 39).<sup>\*)</sup>

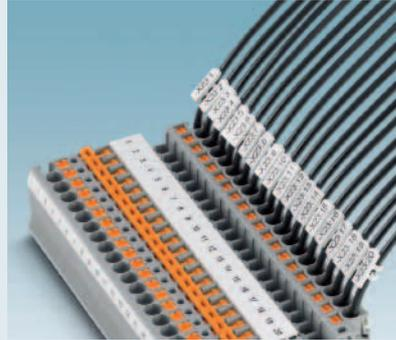

	Conductor diameter [mm]	Lettering field size [mm]	Markers per sheet	Pcs./Pkt.	Type	Order No.	
						WH	YE
	1.5 - 3.2	12 x 4	55	5	UCT-WMS 3,2 (12 x 4) ...	0828570	0828572
	2.5 - 4.7	12 x 5.5	45	5	UCT-WMS 4,7 (12 x 5,5)...	0828571	0828573

	Conductor diameter [mm]	Lettering field size [mm]	Markers per card	Pcs./Pkt.	Type	Order No.
	Depends on marking collars See page 39	10 x 4	112	10	US-WMT (10 x 4)	0828765
		12 x 4	98	10	US-WMT (12 x 4)	0828766
		15 x 4	84	10	US-WMT (15 x 4)	0828767
		18 x 4	70	10	US-WMT (18 x 4)	0828768
		23 x 4	56	10	US-WMT (23 x 4)	0828769
		30 x 4	42	10	US-WMT (30 x 4)	0828770

Conductor diameter [mm]	Lettering field size [mm]	Type	Order No.					
			RD	OG	YE	VT	BU	GN
Depends on marking collars See page 39	10 x 4	US-WMT (10 x 4) ...	0829273	0829274	0828952	0829276	0829277	0829278
	12 x 4	US-WMT (12 x 4) ...	0829280	0829281	0828953	0829283	0829284	0829285
	15 x 4	US-WMT (15 x 4) ...	0829287	0829288	0828954	0829290	0829291	0829292
	18 x 4	US-WMT (18 x 4) ...	0829294	0829295	0828955	0829297	0829298	0829299
	23 x 4	US-WMT (23 x 4) ...	0829301	0829302	0828956	0829304	0829305	0829306
	30 x 4	US-WMT (30 x 4) ...	0829308	0829309	0828957	0829311	0829312	0829313

<sup>\*)</sup> In order to label this material you will need a suitable magazine. See page 6.

## Conductor marking for cable binder mounting and with self-adhesive labels

### UniSheet US-WMTB.../US-WML...

The US-WMTB markers are ideally suited to reliable conductor marking with cable binders (see page 38). The US-WML labels are simply wound around the cables. The transparent protective foil provides support and protection against contamination and abrasion.<sup>\*)</sup>



	Conductor diameter [mm]	Lettering field size [mm]	Markers per card	Pcs./Pkt.	Type	Order No.
						WH
	> 4	24 x 5	35	10	US-WMTB (24 x 5)	<b>0828771</b>
	> 6	29 x 8	24	10	US-WMTB (29 x 8)	<b>0828772</b>
	> 6	44 x 15	12	10	US-WMTB (44 x 15)	<b>0828773</b>

Conductor diameter [mm]	Lettering field size [mm]	Type	Order No.					
			RD	OG	YE	VT	BU	GN
> 4	24 x 5	US-WMTB (24 x 5) ...	<b>0829320</b>	<b>0829321</b>	<b>0828958</b>	<b>0829323</b>	<b>0829324</b>	<b>0829325</b>
> 6	29 x 8	US-WMTB (29 x 8) ...	<b>0829327</b>	<b>0829328</b>	<b>0828959</b>	<b>0829330</b>	<b>0829331</b>	<b>0829332</b>
> 6	44 x 15	US-WMTB (44 x 15) ...	<b>0829334</b>	<b>0829335</b>	<b>0828960</b>	<b>0829337</b>	<b>0829338</b>	<b>0829339</b>

	Conductor diameter [mm]	Lettering field size [mm]	Markers per card	Pcs./Pkt.	Type	Order No.
						WH
	< 6	13 x 13	32	10	US-WML 6 (13 x 13)	<b>0800472</b>
	< 14	25 x 19	8	10	US-WML 14 (25 x 19)	<b>0800473</b>
	< 36	25 x 25	4	10	US-WML 36 (25 x 25)	<b>0800474</b>

<sup>\*)</sup> In order to label this material you will need a suitable magazine. See page 6.

## Device marking for snapping into marker carriers and for rivet or screw mounting

### UniSheet US-EMP... and US-EMSP...

The US-EMP markers are ideally suited to labeling with marker carriers (see page 38–41). The markers are mounted simply by snapping them into place. The US-EMSP markers are securely fitted by means of mounting with rivets or screws.<sup>1) 2)</sup>



	Lettering field size [mm]	Markers per card	Pcs./Pkt.	Type	Order No.		
					WH	YE	SR
	17 x 15	54	10	US-EMP (17 x 15)	0828774	0828774	0828843
	20 x 9	70	10	US-EMP (20 x 9)	0829439		
	25 x 6	84	10	US-EMP (25 x 6)	0829435		
	27 x 8	51	10	US-EMP (27 x 8)	0828775	0828844	0828845
	27 x 12.5	30	10	US-EMP (27 x 12.5)	0828776	0828846	0828847
	27 x 15	27	10	US-EMP (27 x 15)	0828777	0828848	0828849
	27 x 18	21	10	US-EMP (27 x 18)	0828778	0828850	0828851
	27 x 27	15	10	US-EMP (27 x 27)	0828779	0828852	0828853
	29 x 8	48	10	US-EMP (29 x 8)	0829436	0829440	
	40 x 17	16	10	US-EMP (40 x 17)	0829437		
	44 x 7	36	10	US-EMP (44 x 7)	0829438		
	49 x 15	18	10	US-EMP (49 x 15)	0828780	0828854	0828854
	60 x 15	9	10	US-EMP (60 x 15)	0828781	0828856	0828857
	60 x 30	4	10	US-EMP (60 x 30)	0828782	0828858	0828859
85.6 x 54	2	10	US-EMP (85,6 x 54)	0828783	0828860	0828861	
100 x 15	1	10	US-EMP (100 x 15)	0829521	0829522	0829523	
	50 x 30	4	10	US-EMSP (50 x 30)	0828786	0828927	0828928
	75.6 x 54	2	10	US-EMSP (75,6 x 54)	0828787	0828929	0828930
	90 x 60	2	10	US-EMSP (90 x 60)	0828788	0828931	0828932

<sup>1)</sup> In order to label this material you will need a suitable magazine. See page 6.

<sup>2)</sup> For the assignment of these materials to the appropriate products, see page 61 onwards.

## UniSheet US-EMLP../US-EML... and US-EMLC

The US-EMLP markers guarantee a secure fit simply by being glued into marker carriers (see page 41). The US-EML labels are ideal for labeling without marker carriers.

The US-EMLC range can be glued over edges and curves.<sup>\*)</sup>



	Lettering field size [mm]	Markers per card	Pcs./Pkt.	Type	Order No.		
					WH	YE	SR
	11 x 9	135	10	US-EMLP (11 x 9)	0828789	0828871	0828872
	15 x 5	189	10	US-EMLP (15 x 5)	0828790	0828873	0828874
	17 x 7	108	10	US-EMLP (17 x 7)	0828792	0828877	0828878
	17 x 15	54	10	US-EMLP (17 x 15)	0828793	0828879	0828880
	20 x 9	75	10	US-EMLP (20 x 9)	0828795	0828883	0828884
	22 x 22	24	10	US-EMLP (22 x 22)	0828796	0828885	0828886
	27 x 8	51	10	US-EMLP (27 x 8)	0828797	0828889	0828890
	27 x 12,5	30	10	US-EMLP (27 x 12,5)	0828798	0828891	0828892
	27 x 15	27	10	US-EMLP (27 x 15)	0828799	0828893	0828894
	27 x 18	21	10	US-EMLP (27 x 18)	0828800	0828895	0828896
	27 x 27	15	10	US-EMLP (27 x 27)	0828801	0828897	0828898
	35 x 9	45	10	US-EMLP (35 x 9)	0828802	0828899	0829430
	49 x 15	18	10	US-EMLP (49 x 15)	0828803	0828901	0828902
	60 x 15	9	10	US-EMLP (60 x 15)	0828804	0828903	0828904
	60 x 30	4	10	US-EMLP (60 x 30)	0828805	0828905	0828906
85,6 x 54	2	10	US-EMLP (85,6 x 54)	0828806	0828907	0828908	
100 x 60	2	10	US-EMLP (100 x 60)	0828807	0828909	0828910	

	Lettering field size [mm]	Markers per card	Pcs./Pkt.	Type	Order No.		
					WH	YE	SR
	<b>Polyester labels</b>						
	17,5 x 8	80	10	US-EML (17,5 x 8)	0800461	0800463	
	20 x 8	64	10	US-EML (20 x 8)	0800458	0800460	
	104 x 3,8	34	10	US-EML (104 x 3,8)	0800464		
	104 x 140	1	10	US-EML (104 x 140)	0800465	0800467	0800466
	<b>Textile labels</b>						
	20 x 8	64	10	US-EMLC (20 x 8)	0800468	0800469	
	40 x 8	32	10	US-EMLC (40 x 8)	0800470	0800471	

<sup>\*)</sup> In order to label this material you will need a suitable magazine. See page 6.

# THERMOMARK ROLL –

## The perfect printer for marking materials in roll and continuous format

The THERMOMARK ROLL uses the tried-and-tested thermal transfer procedure to print labels and shrink sleeves in roll or continuous format.

The advantage of these formats is the quick and easy labeling of large quantities of the same material, with a significantly reduced need for handling.

The comprehensive range includes markers in a vast range of designs for terminal block, conductor and device marking applications.

You can create the perfect labeling with the CLIP PROJECT software.



## Phoenix Contact terminal block marking for high and flat marker grooves

### Roll material TMT..., TML... and SK...

The TMT markers are pre-perforated and are simply inserted into the marking grooves. With the TML self-adhesive marker strips, unlabeled terminal blocks can be marked quickly and the self-adhesive SK label material allows PCB terminal blocks to be labeled individually.

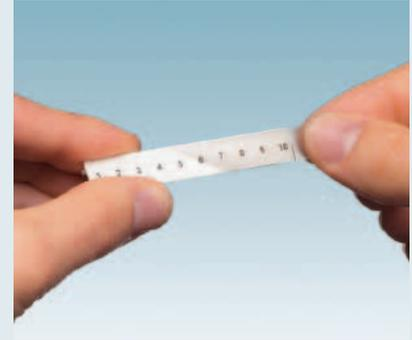
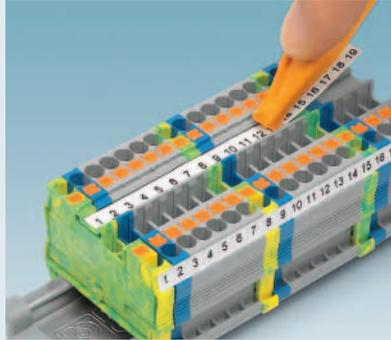

	Terminal block width [mm]	Markers per strip	Pcs./Pkt.	Type	Order No.
					WH
	4.2	24	1 <sup>1)</sup>	TMT 4 R	0816375
	5.2	19	1 <sup>1)</sup>	TMT 5 R	0816430
	6.2	16	1 <sup>1)</sup>	TMT 6 R	0816498
	8.2	12	1 <sup>1)</sup>	TMT 8 R	0816553
	10.2	10	1 <sup>1)</sup>	TMT 10 R	0816210
	Unperforated 101.5	1	1 <sup>1)</sup>	TMT 100 R	0816605
	Locking tool			TMT TOOL	0816650

Terminal block width [mm]	Markers per strip	Type	Order No.				
			RD	OG	YE	BU	GN
4.2	24	TMT 4 R ...	0816362	0816359	0816388	0816333	0816346
5.2	19	TMT 5 R ...	0816427	0816414	0816443	0816391	0816401
6.2	16	TMT 6 R ...	0816485	0816472	0816508	0816456	0816469
8.2	12	TMT 8 R ...	0816540	0816537	0816566	0816511	0816524
101.5	1	TMT 100 R ...	0816595	0816582	0816618	0816223	0816579

	Strip height [mm]	Pcs./Pkt.	Type	Order No.
				TR
	4.2	1 <sup>2)</sup>	TML (101 x 4,2) R TR	0816621
	9.5	1 <sup>1)</sup>	TML (101 x 9,5) R TR	0816647
	4.2	1 <sup>3)</sup>	TML (E x 4,2) R TR	0816715
	9.5	1 <sup>2)</sup>	TML (E x 9,5) R TR	0816634

	Strip height [mm]	Pcs./Pkt.	Strips per roll	Type	Order No.
					WH
	2.8	1 <sup>4)</sup>	14	SK 2,8 WH:REEL	0805205
	3.8	1 <sup>4)</sup>	12	SK 3,8 WH:REEL	0805218
	5	1 <sup>4)</sup>	10	SK 5,0 WH:REEL	0805221
	10	1 <sup>4)</sup>	6	SK10,0 WH:REEL	0812188

<sup>1)</sup> 1 roll = 1000 strips

<sup>3)</sup> 1 roll = 40 m

<sup>2)</sup> 1 roll = 2500 strips

<sup>4)</sup> 1 roll = 90 m

## Conductor marking with self-adhesive labels and for insertion into marking collars

### Roll material WML...

The conductor marker labels consist of a labeling field and a transparent protective foil. This is wound over the labeling and protects it permanently against contamination and abrasion.

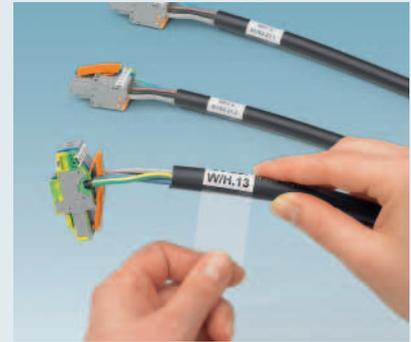
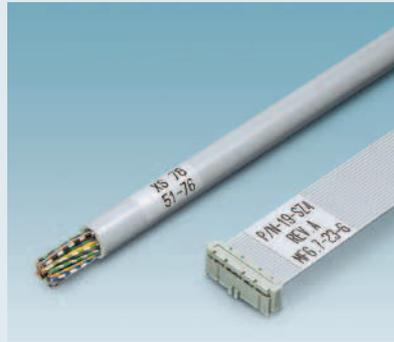

	Conductor diameter [mm]	Lettering field size [mm]	Markers per roll	Type	Order No.	
					WH	YE
	< 3	13 x 10	5000	WML 3 (13 x 10) R	0800073	
	< 5	25 x 10	3000	WML 5 (25 x 10) R	0817523	
	< 6	13 x 13	7000	WML 6 (13 x 13) R	0816252	
	< 7.5	13 x 13	4000	WML 7,5 (13 x 13) R	0800074	
	< 7.5	17 x 9	1500	WML 7,5 (17 x 9) R	0828444	
	< 7.5	25 x 13	2100	WML 7,5 (25 x 13) R	0800075	
	< 12	25 x 19	1000	WML 12 (25 x 19) R	0800076	
	< 14	25 x 19	1500	WML 14 (25 x 19) R	0817536	0817549
	< 14	38 x 19	1000	WML 14 (38 x 19) R	0817552	
	< 18	12 x 12	2500	WML 18 (12 x 12) R	0817507	
	< 20	31 x 25	500	WML 20 (31 x 25) R	0828457	
	< 22	25 x 25	900	WML 22 (25 x 25) R	0800078	
	< 36	25 x 38	500	WML 36 (25 x 38) R	0817510	
	< 46	25 x 38	250	WML 46 (25 x 38) R	0800067	

### Roll material EMT...

The EMT markers are used to label conductors in connection with marking collars (see page 39). The labeled markers are pushed into the appropriate marker carrier and are thus protected against environmental influences.<sup>\*)</sup>

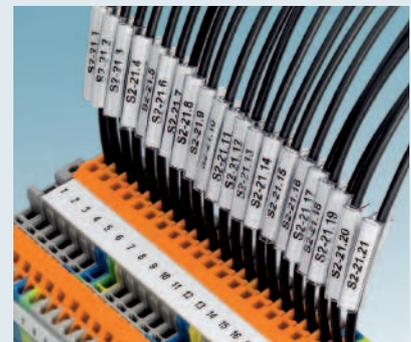

	Lettering field size [mm]	Markers per roll	Pcs./ Pkt.	Type	Order No.			
					WH	YE	RD	BU
	10 x 4	7500	1	EMT (10 x 4) R	0816235			
	15 x 4	7500	1	EMT (15 x 4) R	0817329	0817358	0816249	0817332
	23 x 4	5000	1	EMT (23 x 4) R	0817361	0817374		
	24 x 4	5000	1	EMT (24 x 4) R	0816265			
	25 x 6	5000	1	EMT (25 x 6) R	0817264			
	29 x 8	5400	1	EMT (29 x 8) R	0817277	0817280		
	40 x 17	2300	1	EMT (40 x 17) R	0817293			
	44 x 7	2500	1	EMT (44 x 7) R	0819275			

<sup>\*)</sup> For the assignment of this material to the appropriate products, see page 37 onwards.

## Conductor marking for threading and for cable binder mounting

### Roll material WMT...

The WMT markers, made of polyester foil, are used to label conductors. The printed individual markers are easy to slide onto the conductor and are captively mounted.

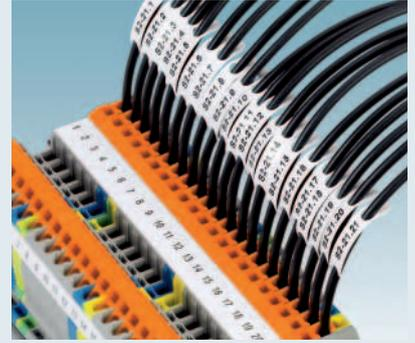

	Conductor diameter [mm]	Lettering field size [mm]	Markers per roll	Type	Order No.
					WH
	1.0 - 2.4	15 x 4	4000	WMT 2.4 (15 x 4) R	<b>0816281</b>
	2.0 - 3.5	15 x 5	4000	WMT 3.5 (15 x 5) R	<b>0817222</b>
	3.0 - 4.2	15 x 6	4000	WMT 4.2 (15 x 6) R	<b>0817235</b>
	4.0 - 5.5	15 x 8	4000	WMT 5.5 (15 x 8) R	<b>0817248</b>
	5.0 - 8.4	17 x 10	4000	WMT 8.4 (17 x 10) R	<b>0817251</b>

### Roll material WMTB...

WMTB conductor marking is ideally suited to marking and also bundling conductors in indoor areas. This marker is made of tear-free polyester foil with fixing loops and is fastened to the conductor with cable binders (see page 38).

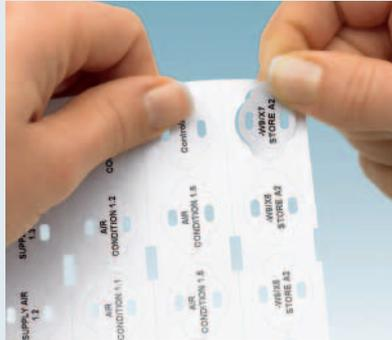

	Conductor diameter [mm]	Lettering field size [mm]	Markers per roll	Pcs./Pkt.	Type	Order No.
						WH
	> 6	24 x 8	4000	1	WMTB (24 x 8) R	<b>0816278</b>
	> 6	35 x 15	1700	1	WMTB (35 x 15) R	<b>0817316</b>

## Conductor marking with marking/shrink sleeves

### Roll material WMS... (pre-assembled)

The shrinkable WMS... marker sleeves are ideally suited to captive cable and conductor marking. The halogen-free, perforated material can be easily separated into smaller sections. They are attached to the conductor by simply threading them on and removing them from the carrier. <sup>1) 2)</sup>

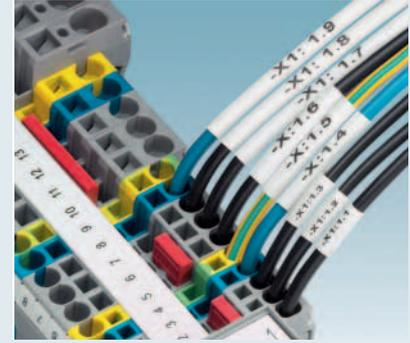

	Conductor diameter [mm]	Lettering field size [mm]	Markers per roll	Type	Order No.	
					WH	YE
	0.8 - 2.4	15 x 4	1000	WMS 2,4 (15 x 4) R	0800379	0800412
	0.8 - 2.4	15 x 4	4000	WMS 2,4 (15 x 4) RL	0800389	
	0.8 - 2.4	15 x 4	10,000	WMS 2,4 (15 x 4) RXL	0800396	
	0.8 - 2.4	30 x 4	500	WMS 2,4 (30 x 4) R	0800373	0800407
	0.8 - 2.4	30 x 4	2000	WMS 2,4 (30 x 4) RL	0800386	
	0.8 - 2.4	30 x 4	5000	WMS 2,4 (30 x 4) RXL	0800394	
	0.8 - 2.4	60 x 4	250	WMS 2,4 (60 x 4) R	0800363	0800398
	0.8 - 2.4	60 x 4	1000	WMS 2,4 (60 x 4) RL	0800383	
	0.8 - 2.4	60 x 4	2500	WMS 2,4 (60 x 4) RXL	0800392	
	1.0 - 3.2	15 x 5	1000	WMS 3,2 (15 x 5) R	0800380	0800413
	1.0 - 3.2	15 x 5	4000	WMS 3,2 (15 x 5) RL	0800390	
	1.0 - 3.2	30 x 5	500	WMS 3,2 (30 x 5) R	0800374	0800408
	1.0 - 3.2	30 x 5	2000	WMS 3,2 (30 x 5) RL	0800387	
	1.0 - 3.2	60 x 5	250	WMS 3,2 (60 x 5) R	0800364	0800399
	1.0 - 3.2	60 x 5	1000	WMS 3,2 (60 x 5) RL	0800384	
	1.6 - 4.8	15 x 9	1000	WMS 4,8 (15 x 9) R	0800382	0800414
	1.6 - 4.8	15 x 9	4000	WMS 4,8 (15 x 9) RL	0800391	
	1.6 - 4.8	15 x 9	10,000	WMS 4,8 (15 x 9) RXL	0800397	
	1.6 - 4.8	30 x 9	500	WMS 4,8 (30 x 9) R	0800375	0800409
	1.6 - 4.8	30 x 9	2000	WMS 4,8 (30 x 9) RL	0800388	
	1.6 - 4.8	30 x 9	5000	WMS 4,8 (30 x 9) RXL	0800395	
	1.6 - 4.8	60 x 9	250	WMS 4,8 (60 x 9) R	0800366	0800400
	1.6 - 4.8	60 x 9	1000	WMS 4,8 (60 x 9) RL	0800385	
	1.6 - 4.8	60 x 9	2500	WMS 4,8 (60 x 9) RXL	0800393	
	2.1 - 6.4	30 x 10	500	WMS 6,4 (30 x 10) R	0800376	0800410
	2.1 - 6.4	60 x 10	250	WMS 6,4 (60 x 10) R	0800367	0800401
	3.1 - 9.5	30 x 16	500	WMS 9,5 (30 x 16) R	0800377	0800411
	3.1 - 9.5	60 x 16	250	WMS 9,5 (60 x 16) R	0800368	0800402
	4.2 - 12.7	60 x 20	250	WMS 12,7 (60 x 20) R	0800369	0800403
	6.4 - 19.1	60 x 30	250	WMS 19,1 (60 x 30) R	0800370	0800404
	8.5 - 25.4	60 x 40	250	WMS 25,4 (60 x 40) R	0800371	0800405
	12.7 - 38.1	60 x 60	250	WMS 38,1 (60 x 60) R	0800372	0800406

<sup>1)</sup> For RL and RXL rolls, an external media hub is required (see page 7).

<sup>2)</sup> For the labeling of WMS material, a special ink ribbon is required (see page 7).

## Conductor marking with continuous marking/shrink sleeves

### Roll material WMS... (continuous)

The shrinkable WMS... marker sleeves are perfectly suited to captive cable and conductor marking. The halogen-free, thin-walled sleeves can be cut to any length using the perforation knife and are then easy to separate. <sup>2) 3) 4)</sup>



	Conductor diameter [mm]	Sleeve length [m]	Markers per roll	Type	Order No.		
					WH	YE	BK
	0.8 - 2.4	30	1	WMS 2.4 (E x 4) R	0800289	0800300	0800415
	0.8 - 2.4	120	1	WMS 2.4 (E x 4) RL	0800319	0800328	0800427
	1.0 - 3.2	30	1	WMS 3.2 (E x 5) R	0800290	0800301	0800416
	1.0 - 3.2	120	1	WMS 3.2 (E x 5) RL	0800320	0800329	0800428
	1.6 - 4.8	30	1	WMS 4.8 (E x 8) R	0800291	0800302	0800418
	1.6 - 4.8	120	1	WMS 4.8 (E x 8) RL	0800321	0800330	0800429
	2.1 - 6.4	25	1	WMS 6.4 (E x 10) R	0800292	0800303	0800419
	2.1 - 6.4	100	1	WMS 6.4 (E x 10) RL	0800322	0800331	0800430
	3.1 - 9.5	20	1	WMS 9.5 (E x 16) R	0800293	0800304	0800421
	3.1 - 9.5	80	1	WMS 9.5 (E x 16) RL	0800324	0800332	0800431
	4.2 - 12.7	20	1	WMS 12.7 (E x 20) R	0800294	0800305	0800422
	4.2 - 12.7	80	1	WMS 12.7 (E x 20) RL	0800325	0800333	0800432
	6.4 - 19.1	20	1	WMS 19.1 (E x 30) R	0800295	0800306	0800423
	6.4 - 19.1	80	1	WMS 19.1 (E x 30) RL	0800326	0800334	0800434
	8.5 - 25.4	15	1	WMS 25.4 (E x 40) R	0800296	0800308	0800424
	8.5 - 25.4	60	1	WMS 25.4 (E x 40) RL	0800327	0800335	0800435
12.7 - 38.1	15	1	WMS 38.1 (E x 60) R	0800298	0800309	0800425	
16.9 - 50.8	15	1	WMS 50.8 (E x 80) R	0800299	0800311	0800426	

<sup>2)</sup> For the labeling of WMS material, a special ink ribbon is required (see page 7).

<sup>3)</sup> For all continuous marker sleeves, an external media hub with an outside diameter of up to 305 is required (see page 7).

<sup>4)</sup> For perforating and cutting the continuous material to length, a cutter is required (see page 7).

## Device marking with self-adhesive labels

### Roll material EML...

The self-adhesive EML... device markers made of high-grade polyester have been developed for the marking of operating equipment in control, system and control cabinet engineering. The device markers are characterized by their high adhesive strength and an accurate printing quality that is resistant to solvents.

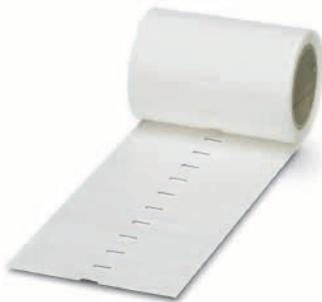
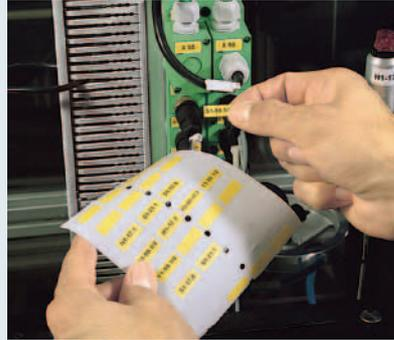

	Lettering field size [mm]	Markers per roll	Pcs./ Pkt.	Type	Order No.			
					WH	YE	SR	TR
	10 x 4	10,000	1	EML (10 x 4) R	0815583			
	10 x 7	10,000	1	EML (10 x 7) R ...	0816663	0816676		
	15 x 6	2500	1	EML (15 x 6) R YE		0819288		
	15 x 9	2500	1	EML (15 x 9) R ...	0815677	0816045	0816032	
	16,5 x 5	2500	1	EML (16,5 x 5) R ...	0816702	0816728		
	16,5 x 5	10,000	1	EML (16,5 x 5) RL	0816113	0816126		
	16 x 7	2500	1	EML (16 x 7) R ...	0818001	0816731		
	17,5 x 8	2500	1	EML (17,5 x 8) R ...	0816744	0816757		
	17,5 x 8	10,000	1	EML (17,5 x 8) RL		0816139		
	18 x 6	10,000	1	EML (18 x 6) RL YE		0828460		
	19 x 6	2500	1	EML (19 x 6) R	0816760			
	20 x 7	2500	1	EML (20 x 7) R YE		0816773		
	20 x 8	2500	1	EML (20 x 8) R...	0816786	0816799		
	21,5 x 21,5	2500	1	EML (21,5 x 21,5) R SR			0816812	
	24 x 4	2500	1	EML (24 x 4) R	0800061			
	25,4 x 12,7	2500	1	EML (25,4 x 12,7) R ...	0816825	0816838		
	25,4 x 12,7	10,000	1	EML (25,4 x 12,7) RL	0816087			
	26,5 x 7,5	1000	1	EML (26,5 x 7,5) R ...			0816841	
	26,5 x 12	2500	1	EML (26,5 x 12) R ...			0816854	
	26,5 x 17,5	2500	1	EML (26,5 x 17,5) R ...		0816896	0816883	
	26,5 x 18,5	2500	1	EML (26,5 x 18,5) R ...			0816906	
	26,5 x 26,5	2500	1	EML (26,5 x 26,5) R ...			0816919	
	30 x 20	2500	1	EML (30 x 20) R ...	0816922	0816935		
	32 x 25	1500	1	EML (32 x 25) R YE		0800020		
	38 x 17	2500	1	EML (38 x 17) R	0816951			
	38,1 x 19	10,000	1	EML (38,1 x 19) RL	0816171			
	40 x 8	1000	1	EML (40 x 8) R	0816980			
	40 x 15	2500	1	EML (40 x 15) R SR			0815729	
	40 x 25	1000	1	EML (40 x 25) R ...	0818027	0816977		
	50,8 x 25,4	3000	1	EML (50,8 x 25,4) RL	0816184			
	51 x 12,5	1000	1	EML (51 x 12,5) R TR				0815745
	51 x 25	1000	1	EML (51 x 25) R ...	0817028	0817031	0817002	
	69,8 x 31,8	10,000	1	EML (69,8 x 31,8) RL	0816197			
	70 x 32	1000	1	EML (70 x 32) R ...	0817060	0817073	0817057	
	70 x 50	400	1	EML (70 x 50) R ...	0817099		0817086	
	76,2 x 6,5	10,000	1	EML (76,2 x 6,5) RL YE		0816207		
	90 x 5	2500	1	EML (90 x 5) R	0817109			
	100 x 40	300	1	EML (100 x 40) R	0800286			
	100 x 73	300	1	EML (100 x 73) R ...	0817125	0817138	0817112	
	100 x 90	250	1	EML (100 x 90) R ...	0817154		0817141	
	101,6 x 25,4	10,000	1	EML (101,6 x 25,4) RL SR			0815790	

## Device marking with self-adhesive labels

### Roll material EML...

The self-adhesive EMLHT markers have been specially developed for high temperatures and can be used continuously under temperatures ranging from  $-40^{\circ}\text{C}$  to  $180^{\circ}\text{C}$ , and up to  $300^{\circ}\text{C}$  for 60 seconds. The textile EMLC makes gluing over edges possible. The particularly flexible EMLF material is ideal for uneven surfaces.

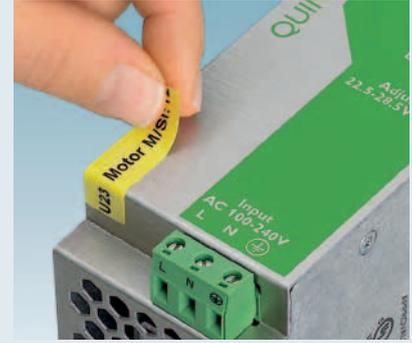

Lettering field size [mm]	Markers per roll	Pcs./ Pkt.	Type	Order No.			
				WH	YE	SR	TR
<b>High-temperature labels</b>							
8 x 8	4000	1	EMLHT (8 x 8) R	<b>0800340</b>			
15 x 15	4000	1	EMLHT (15 x 15) R	<b>0800341</b>			
40 x 15	1000	1	EMLHT (40 x 15) R	<b>0800339</b>			
45 x 5	2500	1	EMLHT (45 x 5) R	<b>0800337</b>			
50 x 10	1000	1	EMLHT (50 x 10) R	<b>0800338</b>			
Ø 12	1000	1	EMLHT (D12) R	<b>0801376</b>			
For high-temperature labels, the EMLHT ink ribbon is required. See page 7							
<b>Textile labels</b>							
15 x 9	2500	1	EMLC (15 x 9) R YE		<b>0800236</b>		
17.5 x 8	2500	1	EMLC (17.5 x 8) R YE		<b>0800237</b>		
20 x 8	2500	1	EMLC (20 x 8) R YE		<b>0800235</b>		
25 x 8	2500	1	EMLC (25 x 8) R YE		<b>0800240</b>		
25.4 x 12.7	2500	1	EMLC (25.4 x 12.7) R YE		<b>0800238</b>		
38 x 17	1000	1	EMLC (38 x 17) R YE		<b>0800557</b>		
40 x 8	1000	1	EMLC (40 x 8) R ...	<b>0800554</b>	<b>0800555</b>		
51 x 25	750	1	EMLC (51 x 25) R YE		<b>0800558</b>		
<b>Flexible PVC labels</b>							
108 x E	1	2 <sup>2)</sup>	EMLF (108 x E) R ...	<b>0800549</b>	<b>0800550</b>	<b>0800551</b>	<b>0800552</b>
<b>Continuous polyester labels</b>							
37 x E	1	1 <sup>1)</sup>	EML (37 x E) R TR				<b>0815716</b>
100 x E	1	1 <sup>1)</sup>	EML (100 x E) RL SR			<b>0815787</b>	
<b>Round polyester labels</b>							
Ø 17.5	2500	1	EML (D17.5) R	<b>0815774</b>			

<sup>1)</sup> 1 roll = 90 m

<sup>2)</sup> 1 roll = 40 m

## Device marking with self-adhesive labels

### Roll material EMLP...

The self-adhesive EMLP labels have a high-quality appearance and a high resistance to chemical and mechanical influences. The markers are used to label components, devices and buttons.<sup>\*)</sup>



	Lettering field size [mm]	Markers per roll	Pcs./ Pkt.	Type	Order No.	
					WH	SR
	13 x 9	500	1	EMLP (13 x 9) R	<b>0819453</b>	
	17.5 x 12	500	1	EMLP (17,5 x 12) R	<b>0819466</b>	
	17 x 7	500	1	EMLP (17 x 7) R	<b>0826844</b>	
	20 x 7	500	1	EMLP (20 x 7) R	<b>0819479</b>	
	20 x 8	500	1	EMLP (20 x 8) R	<b>0819482</b>	
	22 x 12	500	1	EMLP (22 x 12) R	<b>0819495</b>	
	22 x 22	500	1	EMLP (22 x 22) R SR		<b>0825528</b>
	27 x 8	500	1	EMLP (27 x 8) R SR		<b>0819518</b>
	27 x 12.5	500	1	EMLP (27 x 12,5) R SR		<b>0819521</b>
	27 x 18	500	1	EMLP (27 x 18) R SR		<b>0819534</b>
	27 x 27	500	1	EMLP (27 x 27) R SR		<b>0827467</b>
	45 x 15	500	1	EMLP (45 x 15) R SR		<b>0819547</b>
60 x 30	250	1	EMLP (60 x 30) R	<b>0817510</b>		

	Lettering field size [mm]	Markers per roll	Pcs./ Pkt.	Type	Order No.	
					WH	SR
	30 x 12	500	1	EMLP 24 (30 x 12) R ...	<b>0819550</b>	<b>0819563</b>

<sup>\*)</sup> For the assignment of these materials to the appropriate products, see page 62.

## Device marking with self-adhesive safety labels and for snapping in

### Roll material EMLS...

When this tamper-proof label is detached (can be used, e.g., as a rating plate or security label), a part of the metal-plated layer is also detached and leaves a triangular pattern on the label and the background.



	Lettering field size [mm]	Markers per roll	Pcs./Pkt.	Type	Order No.		
					SR		
	15 x 9	2500	1	EMLS (15 x 9) R SR	<b>0800347</b>		
	19 x 6	2500	1	EMLS (19 x 6) R SR	<b>0800343</b>		
	20 x 20	1000	1	EMLS (20 x 20) R SR	<b>0800344</b>		
	26.5 x 12	1000	1	EMLS (26.5 x 12) R SR	<b>0800353</b>		
	38.1 x 19	1000	1	EMLS (38.1 x 19) R SR	<b>0800354</b>		
	40 x 8	1000	1	EMLS (40 x 8) R SR	<b>0800348</b>		
	45 x 15	1000	1	EMLS (45 x 15) R SR	<b>0800345</b>		
	60 x 30	500	1	EMLS (60 x 30) R SR	<b>0800355</b>		
	70 x 32	500	1	EMLS (70 x 32) R SR	<b>0800346</b>		
	70 x 150	100	1	EMLS (70 x 150) R SR	<b>0800351</b>		
	76 x 51	250	1	EMLS (76 x 51) R SR	<b>0800350</b>		
85 x 32	250	1	EMLS (85 x 32) R SR	<b>0800356</b>			

### Roll material EMT...

A range of EMT markers in various sizes and colors is available for the labeling of controllers and modules, including those from other manufacturers.\*)

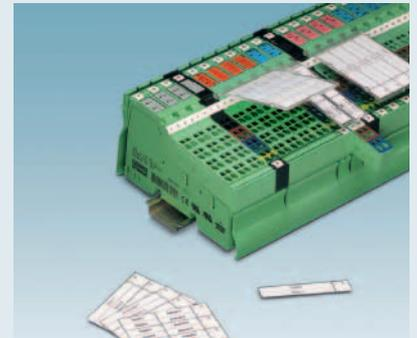

	Lettering field size [mm]	Markers per roll	Pcs./Pkt.	Type	Order No.		
					WH	YE	TQ
	50 x 13	500	1	EMT (50/28 x 13) R ...	<b>0800049</b>	<b>0800438</b>	<b>0800050</b>
	50 x 26	500	1	EMT (50 x 26) R ...	<b>0800052</b>	<b>0800054</b>	<b>0800053</b>
	62 x 10	500	1	EMT (62 x 10) R ...	<b>0800057</b>	<b>0800477</b>	
	62 x 46	250	1	EMT (62 x 46) R ...	<b>0800059</b>	<b>0800478</b>	
	103 x 17	500	1	EMT (103 x 17) R ...	<b>0800039</b>	<b>0800436</b>	<b>0800041</b>
	103 x 23	500	1	EMT (103 x 23) R ...	<b>0800040</b>	<b>0800437</b>	<b>0800437</b>

\*) For the assignment of this material to the appropriate products, see page 60 onwards.

## Shock protection labels and covers

### Transparent covers EMLPR... and EMPPR...

The very thick yet flexible EMLPR... shock protection is simply bonded over the labeled markers and provides a high degree of protection against chemical and mechanical influences. The EMPPR... range has the same function, but these are snapped over the labels into the CARRIERS provided.



	Cover size [mm]	Foils per card	Type	Order No.
	26.5 x 14.5	51	EMLPR (26,5 x 14,5)	<b>0800546</b>
	26.5 x 17.5	42	EMLPR (26,5 x 17,5)	<b>0800360</b>
	26.5 x 26.5	30	EMLPR (26,5 x 26,5)	<b>0800361</b>
	30 x 40	14	EMLPR (30 x 40)	<b>0800359</b>
	80 x 42	6	EMLPR (80 x 42)	<b>0800357</b>
	80 x 60	4	EMLPR (80 x 60)	<b>0800358</b>
	100 x 30	9	EMLPR (100 x 30)	<b>0800362</b>

	Cover size [mm]	For marker carriers	Type	Order No.
	27 x 15	CARRIER-EMP 22 (27 x 15) See page 41	EMPPR (27 x 15)	<b>0829535</b>
	27 x 18	CARRIER-EMP 22 (27 x 18) See page 41	EMPPR (27 x 18)	<b>0829536</b>

## Marker carriers for terminal marking

### Marker carriers STP...

The marker carriers help in the labeling of wired multi-level terminal blocks. Depending on the design, the carriers are either plugged into the sockets of the upper terminal level or are snapped into the uppermost marking groove where available.

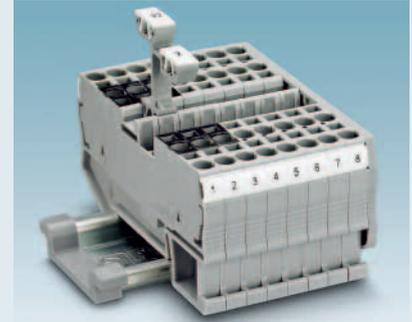

	Terminal block width [mm]	Type	Order No.	Pcs./Pkt.	Can be labeled with type	Order No.
	> 3.5	STP 3,5-2	<b>0830131</b>	100	UCT-TM 3,5	<b>0829484</b>
	> 3.5	STP 3,5-3	<b>0830132</b>	100	UCT-TM 3,5	<b>0829484</b>
	> 4	STP 4-2	<b>0810575</b>	100	UCT-TM 4	<b>0828732</b>
	> 5	STP 5-2	<b>0800967</b>	100	UCT-TM 5	<b>0828734</b>
	> 5	STP 5-3	<b>0810562</b>	100	UCT-TM 5	<b>0828734</b>
	> 5	STP 5-2/S	<b>0800970</b>	100	UCT-TM 5	<b>0828734</b>
	> 4	STP 4-2-ZB	<b>3038613</b>	100	UCT-TM 4	<b>0828732</b>
	> 5	STP 5-2-ZB	<b>3037643</b>	100	UCT-TM 5	<b>0828734</b>

### Terminal block group marking

Terminal block groups are marked using marking labels that are snapped into the high marker groove of the terminal blocks. The foot of the marking labels is designed in such a way that the actual terminal point labeling is thoroughly retained.

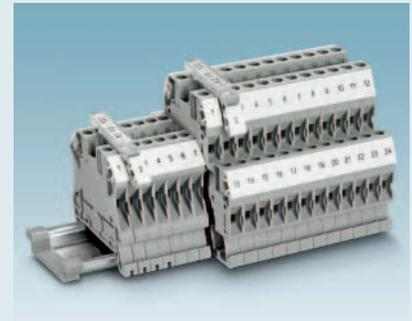
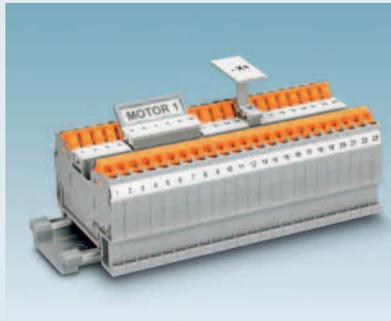

	Type	Order No.	Pcs./Pkt.	Can be labeled with type	Order No.
	GBS 5-25 x 5	<b>0829126</b>	100	UCT-TM 5	<b>0828734</b>
				UCT-TM 6	<b>0828736</b>
	GBS 5-25 x 12	<b>0810588</b>	100	EML (24 x 4)R	<b>0800061</b>
				UCT-TM 5	<b>0828734</b>
	GBS-ZB/26 x 6	<b>0809298</b>	100	UCT-TM 6	<b>0828736</b>
				EML (25,4 x 12,7) R	<b>0816825</b>
	AK-DST/UK	<b>1000708</b>	50	UCT-TM...	
				EMT (25 x 6) R	<b>0817264</b>
	AK-DST/DIK	<b>1000779</b>	50	US-EMP (25 x 6)	<b>0829435</b>
				EMT (24 x 4) R	<b>0816265</b>
	UBE	<b>0800310</b>	10	UCT-TM 5	<b>0828734</b>
				EMT (24 x 4) R	<b>0816265</b>
	UBE/D	<b>0800307</b>	10	US-EMP (40 x 17)	<b>0829437</b>
				EMT (40 x 17) R	<b>0817293</b>
				US-EMP (40 x 17)	<b>0829437</b>
				EMT (40 x 17) R	<b>0817293</b>

## Marker carriers for terminal strip marking

### Terminal strip marking KLM

Terminal strip markers are used for labeling both groups and partitions. The markers can be mounted on various end brackets.



	Type	Pcs./Pkt.	Order No.	Can be labeled with type	Order No.
	KLM (for end brackets CLIPFIX 35 and E/UK)	100	<b>1004306</b>	US-EMP (25 x 6)	<b>0829435</b>
				EMT (25 x 6) R	<b>0817264</b>
	KLM 1 (for end brackets E/MK, E/MK 1 and E/MBK)	100	<b>1004319</b>	EMT (24 x 4) R	<b>0816265</b>
	KLM 2 (for end brackets CLIPFIX...)	100	<b>0807575</b>	UCT-TM 4 - UCT-TM 16	
	KLM 3 (for end brackets CLIPFIX...)	100	<b>0811969</b>	US-EML (20 x 8)	<b>0800458</b>
				EML (20 x 8) R	<b>0816786</b>
				EMLP (20 x 8) R	<b>0819482</b>
				EMLC (20 x 8) R YE	<b>0800235</b>
	KLM 3-L (for end brackets CLIPFIX...)	100	<b>0814788</b>	US-EML (20 x 8)	<b>0800458</b>
				EML (20 x 8) R	<b>0816786</b>
				EMLP (20 x 8) R	<b>0819482</b>
				EMLC (20 x 8) R YE	<b>0800235</b>
	KLM-A (for end brackets CLIPFIX 35, E/UK and E/NS 35 N)	100	<b>1004348</b>	US-EMP (44 x 7)	<b>0829438</b>
				EMT (44 x 7)	<b>0819275</b>

### Cable binders PKB...

Cable binders have been used to bundle control cables and other cables for decades.

They are ideal for fixing cables and as an accessory for various cable markers.



	Length/width [mm]	Pcs./Pkt.	Color	Type	Order No.
	100 x 2.5	1000	Transparent	PKB 100 x 2,5	<b>1005457</b>
	140 x 3.6	1000	Transparent	PKB 140 x 3,6	<b>1005460</b>
	190 x 4.8	1000	Transparent	PKB 190 x 4,8	<b>1005473</b>
	200 x 2.5	1000	Transparent	PKB 200 x 2,5	<b>1005486</b>
	290 x 4.8	1000	Transparent	PKB 290 x 4,8	<b>1005499</b>
	370 x 4.8	1000	Transparent	PKB 370 x 4,8	<b>1005509</b>
	100 x 2.5	1000		PKB 100 x 2,5 BK	<b>1005512</b>
	140 x 3.6	1000		PKB 140 x 3,6 BK	<b>1005525</b>
	190 x 4.8	1000		PKB 190 x 4,8 BK	<b>1005538</b>
	200 x 2.5	1000		PKB 200 x 2,5 BK	<b>1005541</b>
	290 x 4.8	1000		PKB 290 x 4,8 BK	<b>1005554</b>
	370 x 4.8	1000		PKB 370 x 4,8 BK	<b>1005567</b>

## Marker carriers for conductor marking

### Marking collars PATG... and PAB KTL...

The closed PATG marking collars are pushed onto the conductor before it is connected. The PAB-KTL... collars are particularly suited to the identification and simultaneous bundling of conductors with cable binder mounting.\*)



Can be labeled with type	Conductor diameter [mm]	Pcs./Pkt.	Type	Order No.	
US-WMT (10 x 4)... and EMT (10 x 4) See page 22 and 28	0.6 - 1.2	1000	PATG 0/10	1013795	
	1.5 - 2.5	1000	PATG 1/10	1013805	
	2.0 - 4.0	1000	PATG 2/10	1013818	
	4.0 - 7.0	500	PATG 3/10	1013821	
US-WMT (12 x 4)... See page 22	0.6 - 1.2	1000	PATG 0/12	0827076	
	1.5 - 2.5	1000	PATG 1/12	0827077	
	2.0 - 4.0	1000	PATG 2/12	0827078	
	4.0 - 7.0	500	PATG 3/12	0827079	
	6.0 - 10.0	500	PATG 4/12	0827080	
US-WMT (15 x 4)... and EMT (15 x 4) See page 22 and 28	0.6 - 1.2	1000	PATG 0/15	1013740	
	1.5 - 2.5	1000	PATG 1/15	1013025	
	2.0 - 4.0	1000	PATG 2/15	1013038	
	4.0 - 7.0	500	PATG 3/15	1013041	
	6.0 - 10.0	500	PATG 4/15	1013054	
	10.0 - 14.0	200	PATG 5/15	1013067	
	14.0 - 22.0	200	PATG 6/15	1013070	
US-WMT (18 x 4)... See page 22	0.6 - 1.2	1000	PATG 0/18	0820507	
	1.5 - 2.5	1000	PATG 1/18	0820510	
	2.0 - 4.0	1000	PATG 2/18	0820523	
	4.0 - 7.0	500	PATG 3/18	0820536	
	6.0 - 10.0	500	PATG 4/18	0820549	
	10.0 - 14.0	200	PATG 5/18	0828059	
	14.0 - 22.0	200	PATG 6/18	0828062	
US-WMT (23 x 4)... and EMT (23 x 4) See page 22 and 28	0.6 - 1.2	1000	PATG 0/23	0828046	
	1.5 - 2.5	1000	PATG 1/23	1013847	
	2.0 - 4.0	500	PATG 2/23	1013850	
	4.0 - 7.0	500	PATG 3/23	1013863	
	6.0 - 10.0	200	PATG 4/23	0808011	
	10.0 - 14.0	200	PATG 5/23	0808024	
	14.0 - 22.0	100	PATG 6/23	0808037	
	1)	200	PAB-KTL 23	1013957	
	US-WMT (30 x 4)... See page 22	1.5 - 2.5	500	PATG 1/30	0822440
		2.0 - 4.0	500	PATG 2/30	0822453
4.0 - 7.0		200	PATG 3/30	0822466	
6.0 - 10.0		200	PATG 4/30	0822479	
10.0 - 14.0		200	PATG 5/30	0822482	
1)	200	PAB-KTL	1013261		

\*) For suitable cable binders, see page 38.

## Marker carriers for conductor marking

### Plastic conductor markers KMK...

KMK plastic cable markers combine the functions of conductor marking and conductor bundling. Suitable insert labels are inserted into the markers and they are then sealed tightly.\*\*)



	Type	Pcs./Pkt.	Order No.	Can be labeled with type	Order No.
	KMK	100	<b>1005208</b>	US-EMP (29 x 8)	<b>0829436</b>
				EMT (29 x 8) R	<b>0817277</b>
	KMK 2	100	<b>1005266</b>	US-EMP (29 x 8)	<b>0829436</b>
				EMT (29 x 8) R	<b>0817277</b>
	KMK 3	50	<b>1005211</b>	US-EMP (40 x 17)	<b>0829437</b>
				EMT (40 x 17) R	<b>0819275</b>
	KMK 4	50	<b>1005305</b>	US-EMP (40 x 17)	<b>0829437</b>
				EMT (40 x 17) R	<b>0819275</b>

### Conductor markers LM and KME

The LM and KME conductor markers consist of a plastic label with an injection molded cable binder. The transparent sealing cap of the LM holds the printed label and protects it from contamination. The KME is directly labeled with a self-adhesive label.

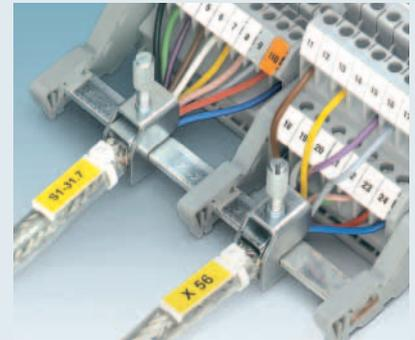
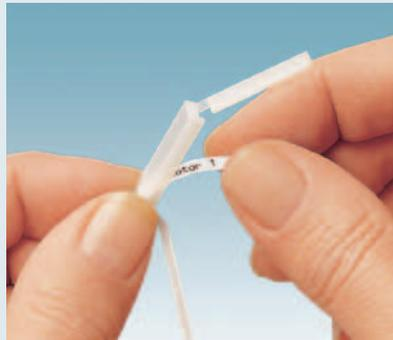

	Type	Pcs./Pkt.	Order No.	Can be labeled with type	Order No.
	LM	100	<b>1004377</b>	EMT (24 x 4) R	<b>0816265</b>
	KME	50	<b>0807083</b>	EML (20 x 8)	<b>0816786</b>
				EMLC (20 x 8) R	<b>0800235</b>
				EMLP (20 x 8) R	<b>0819482</b>

\*\*) For suitable cable binders, see page 38.

## Marker carriers for device marking

### Device markers CARRIER-EMP 22, -EMLP 22 and -EMP

CARRIER-EMP 22 and -EMLP 22 marker carriers, with the appropriate markers, are used for the identification of buttons and switches. With the -EMP 22, markers are effortlessly snapped into place and with the -EMLP 22 they are adhered. Together with US-EMP... markers, the CARRIER-EMPs mark devices and control cabinets. The material is easily snapped into place.



	Can be labeled with type	Pcs./ Pkt.	Type	Order No.		
				BK	TR	GY
	US-EMP (27 x 8)... See page 24	50	CARRIER-EMP 22 (27 x 8)	<b>0827445</b>		
	US-EMP (27 x 12,5)... See page 24	50	CARRIER-EMP 22 (27 x 12,5)	<b>0827446</b>		
	US-EMP (27 x 15)... See page 24	50	CARRIER-EMP 22 (27 x 15)	<b>0827447</b>		
	US-EMP (27 x 18)... See page 24	50	CARRIER-EMP 22 (27 x 18)	<b>0827448</b>		
	US-EMP (27 x 27)... See page 24	50	CARRIER-EMP 22 (27 x 27)	<b>0827449</b>		
	US-EMLP (27 x 8)..., EML (26,5 x 7,5) R and EMLP (27 x 8) R SR See page 25, 32 and 34	50	CARRIER-EMLP 22 (27 x 8)	<b>0828984</b>		
	US-EMLP (27 x 12,5)..., EML (26,5 x 12,5) R and EMLP (27 x 12,5) R SR See page 25, 32 and 34	50	CARRIER-EMLP 22 (27 x 12,5)	<b>0828985</b>		
	US-EMLP (27 x 15) See page 25	50	CARRIER-EMLP 22 (27 x 15)	<b>0828986</b>		
	US-EMLP (27 x 18)..., EML (26,5 x 17,5) R and EMLP (27 x 18) R SR See page 25, 32 and 34	50	CARRIER-EMLP 22 (27 x 18)	<b>0828987</b>		
	US-EMLP (27 x 27)..., EML (26,5 x 26,5) R and EMLP (27 x 27) R SR See page 25, 32 and 34	50	CARRIER-EMLP 22 (27 x 27)	<b>0828988</b>		
	US-EMP (17 x 15)... See page 24	80	CARRIER-EMP (17 x 15)	<b>0827450</b>		
	US-EMP (27 x 15)... See page 24	80	CARRIER-EMP (27 x 15)	<b>0827451</b>		
	US-EMP (49 x 15)... See page 24	40	CARRIER-EMP (49 x 15)	<b>0827452</b>		
	US-EMP (60 x 15)... See page 24	40	CARRIER-EMP (60 x 15)	<b>0827453</b>		
	US-EMP (60 x 30)... See page 24	30	CARRIER-EMP (60 x 30)	<b>0827454</b>		
	US-EMP (85,6 x 54)... See page 24	10	CARRIER-EMP (85,6 x 54)	<b>0829365</b>		
	US-EMP (X x 15)... See page 24	25	CARRIER-EMP (1000 x 15)...		<b>0829530</b>	<b>0829366</b>
	US-EMP (X x 15)... See page 24	25	CARRIER/L-EMP (1000 x 15)...		<b>0829560</b>	<b>0829559</b>
	Cover for CARRIER/L-EMP (1000 x 15)	25	CARRIER-EMP (1000 x 15) COVER		<b>0829520</b>	



# Terminal block marking for Phoenix Contact



Large terminal markers for central and external labeling

	UCT-TM 3,5	UCT-TM 4	UCT-TM 5	UCT-TM 6	UCT-TM 7,62	UCT-TM 8	UCT-TM 10	UCT-TM 12	UCT-TM 16
	See page 19								
		TMT 4 R	TMT 5 R	TMT 6 R		TMT 8 R	TMT 10 R	TMT 100 R	TMT 100 R
	See page 27								
Pitch	3.5	4	5	6	7.62	8	10	12	16

## Screw terminal blocks

UT 2,5..., UTTB 2,5..., UTN 2,5...	5								
UT 4..., UTTB 4..., UTME(D) 4..., USST 4..., UTN 4...	6								
UT 6..., UTME(D) 6..., USST 6..., UTN 6...	8								
UT 10..., USST 10...	10								
UT 16..., UTI 16...	12								
UT 35	16								
UK 1,5 N..., USLKG 1,5 N	4								
UK 2,5 N..., USLKG 2,5 N, UK 3 N..., USLKG 3, UKK(B) 3..., UDK 3..., MTK(D)...	5								
UK 5 N..., USLKG 5 N, UDK 4..., UKK(B) 5, UDMTK(B) 5..., UKN 2,5..., UKN 5..., PIK 4...	6								
UK 6 N..., USLKG 6 N, UKN 6..., PIK 6..., URTK..., UGSK..., URDK...	8								
UK 10 N..., USLKG 10 N, UKKB 10..., UKN 10...	10								
U(I)K 16..., U(I)SLKG 16, UIKN 16...	12								
U(I)K 35..., U(I)SLKG 35, UIKN 35...	15								
UKH..., USLKG 50/95	>16								
DIK(D) 1,5..., DOK(D) 1,5..., VIOK 1,5..., DLK(B) 2,5..., SLKK 5...	6								
UVKB 4..., UHK 4..., USK 4..., UK 4..., UKK 4..., VBST 4...	6								
TMC..., TMCP SOCKET...	12								
UK 5-HESI..., UKK 5-HESI..., UK-SI..., UK 6-FSI..., UK 10-DREHSI...	8								
UK 6,3-HESI..., USIG...	10								
MT 1,5..., MTTB 1,5...	4								
MBK..., MBK 2,5..., MBK 3..., MSLKG 2,5, MBKKB 2,5...	5								
MBK 5..., MSLKG 5	6								
MBK 6..., MSLKG 6	8								
DFK 4...	6								
DFK 5...	9.5								
UW(V) 4...	8								
UW(V) 10.../16.../25...	≥ 10								
HDFK(V) 50..., HDFK(V) 95...	> 18								

All terminal blocks can also be labeled with the UniSheet material US-TMF 100.

 The pitch of the terminal block corresponds to the width of the label

 The pitch of the terminal block is greater than the width of the label

# Terminal block marking for Phoenix Contact



	UCT-TMF 3,5	UCT-TMF 4	UCT-TMF 5	UCT-TMF 6	UCT-TMF 8	UCT-TMF 10	UCT-TMF 12	UCT-TMF 16	
	See page 19								
		TMT 4 R	TMT 5 R	TMT 6 R	TMT 8 R	TMT 10 R	TMT 100 R	TMT 100 R	
	See page 27								
Small terminal markers for central and external labeling	Pitch	3.5	4	5	6	8	10	12	16

## Screw terminal blocks

UT 2,5..., UTTB 2,5..., UTN 2,5...	5								
UT 4..., UTTB 4..., UTME(D) 4..., USST 4..., UTN 4...	6								
UT 6..., UTME(D) 6..., USST 6..., UTN 6...	8								
UT 10..., USST 10...	10								
UT 16..., UTI 16...	12								
UT 35	16								
UK 1,5 N..., USLKG 1,5 N	4								
UK 2,5 N..., USLKG 2,5 N, UK 3 N..., USLKG 3, UKK(B) 3..., UDK 3..., MTK(D)...	5								
UK 5 N..., USLKG 5 N, UDK 4..., UKK(B) 5, UDMTK(B) 5..., UKN 2,5..., UKN 5..., PIK 4...	6								
UK 6 N..., USLKG 6 N, UKN 6..., PIK 6..., URTK..., UGSK..., URDK...	8								
UK 10 N..., USLKG 10 N, UKKB 10..., UKN 10...	10								
U(I)K 16..., U(I)SLKG 16, UIKN 16...	12								
U(I)K 35..., U(I)SLKG 35, UIKN 35...	15								
UKH..., USLKG 50/95	>16								
DIK(D) 1,5..., DOK(D) 1,5..., VIOK 1,5..., DLK(B) 2,5..., SLKK 5...	6								
UVKB 4..., UHK 4..., USK 4..., UK 4..., UKK 4..., VBST 4...	6								
TMC..., TMCP SOCKET...	12								
UK 5-HESI..., UKK 5-HESI..., UK-SI..., UK 6-FSI..., UK 10-DREHSI...	8								
UK 6,3-HESI..., USIG...	10								
MT 1,5..., MTTB 1,5...	4								
MBK..., MBK 2,5..., MBK 3..., MSLKG 2,5, MBKKB 2,5...	5								
MBK 5..., MSLKG 5	6								
MBK 6 ..., MSLKG 6	8								
DFK 4...	6								
DFK 5...	9.5								
UW(V) 4...	8								
UW(V) 10.../16.../25...	≥ 10								
HDFK(V) 50..., HDFK(V) 95...	>18								

All terminal blocks can also be labeled with the UniSheet material US-TMF 100.

 The pitch of the terminal block corresponds to the width of the label

 The pitch of the terminal block is greater than the width of the label

# Terminal block marking for Phoenix Contact



Large terminal markers for central labeling

	UCT-TM 3,5	UCT-TM 4	UCT-TM 5	UCT-TM 6	UCT-TM 7,62	UCT-TM 8	UCT-TM 10	UCT-TM 12	UCT-TM 16
	See page 19								
	TMT 4 R	TMT 5 R	TMT 6 R			TMT 8 R	TMT 10 R	TMT 100 R	TMT 100 R
	See page 27								
Pitch	3.5	4	5	6	7.62	8	10	12	16

## Spring-cage terminal blocks

Terminal Block	Pitch	3.5	4	5	6	7.62	8	10	12	16
ST 1,5/S...	3.5	Green								
ST 1,5...	4	Green	Green							
ST 2,5... (except ST 2,5-3L...)	5	Green	Green	Green						
ST 4...	6	Green	Green	Green	Green					
ST 6..., STME(D) 6...	8	Green	Green	Green	Green	Green	Green			
ST 10...	10	Green	Green	Green	Green	Green	Green	Green		
ST 16...	12	Green	Green	Green	Green	Green	Green	Green	Green	
ST 35...	16	Green	Green	Green	Green	Green	Green	Green	Green	Green
ST 4-HESI (6,3 x 32), ST 4-FSI...	8	Green	Green	Green	Green	Green	Green			
STU 2,5...	5	Green	Green	Green						
STU 4..., STTBU 4...	6	Green	Green	Green	Green					
STU 10...	10	Green	Green	Green	Green	Green	Green	Green		
STU 35...	16	Green	Green	Green	Green	Green	Green	Green	Green	Green
STS 2,5..., STTBS 2,5...	5	Green	Green	Green						
STS 4..., STTBS 4...	6	Green	Green	Green	Green					
STS 6...	8	Green	Green	Green	Green	Green	Green			
STI 2,5..., STN 2,5...	5	Green	Green	Green						
STI 4..., STN 4...	6	Green	Green	Green	Green					
STI 10..., STN 10...	10	Green	Green	Green	Green	Green	Green	Green		
STI 16..., STN 16...	12	Green	Green	Green	Green	Green	Green	Green	Green	
STN 35...	16	Green	Green	Green	Green	Green	Green	Green	Green	Green
SRTK 6..., SGSK 6..., SRDK 6...	8	Green	Green	Green	Green	Green	Green			
MSB(V) 2,5.../MSDB(V) 2,5...	5	Green	Green	Green						
ZRV...	7.62	Green	Green	Green	Green	Green				
ZRTK..., ZGSK..., ZRDK...	8	Green	Green	Green	Green	Green	Green			

All terminal blocks can also be labeled with the UniSheet material US-TMF 100.

The pitch of the terminal block corresponds to the width of the label

The pitch of the terminal block is greater than the width of the label

# Terminal block marking for Phoenix Contact



UCT-TMF 3,5 UCT-TMF 4 UCT-TMF 5 UCT-TMF 6 UCT-TMF 8 UCT-TMF 10 UCT-TMF 12 UCT-TMF 16

See page 19

TMT 4 R TMT 5 R TMT 6 R TMT 8 R TMT 10 R TMT 100 R TMT 100 R

See page 27

Small terminal markers for central and external labeling

Pitch	3.5	4	5	6	8	10	12	16
-------	-----	---	---	---	---	----	----	----

## Spring-cage terminal blocks

Terminal Block	Pitch	3.5	4	5	6	8	10	12	16
ST 1,5/S...	3.5	Green							
ST 1,5..., STTB 1,5...	4	Green	Green						
ST 2,5..., STTB 2,5..., ST 2,5-3..., STIO...	5	Green	Green	Green					
ST 4..., STTB 4...	6	Green	Green	Green	Green				
ST 6..., STME(D) 6...	8	Green	Green	Green	Green	Green			
ST 10...	10	Green	Green	Green	Green	Green	Green		
ST 16...	12	Green	Green	Green	Green	Green	Green	Green	
ST 35...	16	Green	Green	Green	Green	Green	Green	Green	Green
ST 4-HESI (6,3 x 32), ST 4-FSI...	8	Green	Green	Green	Green	Green			
STU 2,5...	5	Green	Green	Green					
STU 4..., STTB 4...	6	Green	Green	Green	Green				
STU 10...	10	Green	Green	Green	Green	Green			
STU 35...	16	Green	Green	Green	Green	Green	Green	Green	Green
STS 2,5..., STTBS 2,5...	5	Green	Green	Green					
STS 4..., STTBS 4...	6	Green	Green	Green	Green				
STS 6...	8	Green	Green	Green	Green	Green			
STI 2,5..., STN 2,5...	5	Green	Green	Green					
STI 4..., STN 4...	6	Green	Green	Green	Green				
STI 10..., STN 10...	10	Green	Green	Green	Green	Green			
STI 16..., STN 16...	12	Green	Green	Green	Green	Green	Green		
STN 35...	16	Green	Green	Green	Green	Green	Green	Green	Green
SRTK 6..., SGSK 6..., SRDK 6...	8	Green	Green	Green	Green	Green			
MSB(V) 2,5.../MSDB(V) 2,5...	5/10	Green	Green	Green					
ZRV...	7.62	Green	Green	Green	Green				
ZRTK..., ZGSK..., ZRDK...	8	Green	Green	Green	Green	Green			
ZFK 6-DREHSI...	12	Green	Green	Green	Green	Green	Green	Green	
ZFKK 2,5...	5	Green	Green	Green					
ZDMTK 2,5...	6	Green	Green	Green	Green				
ZPV...	5	Green	Green	Green					
MZFK(K) 1,5..., MZB 1,5...	5	Green	Green	Green					
MZDB 1,5...	10	Green	Green	Green	Green	Green	Green		

All terminal blocks can also be labeled with the UniSheet material US-TMF 100.

 The pitch of the terminal block corresponds to the width of the label

 The pitch of the terminal block is greater than the width of the label

# Terminal block marking for Phoenix Contact



Large terminal markers for central and external labeling

	UCT-TM 3,5	UCT-TM 4	UCT-TM 5	UCT-TM 6	UCT-TM 7,62	UCT-TM 8	UCT-TM 10	UCT-TM 12	UCT-TM 16
	See page 19								
	TMT 4 R	TMT 5 R	TMT 6 R			TMT 8 R	TMT 10 R	TMT 100 R	TMT 100 R
	See page 27								
Pitch	3.5	4	5	6	7.62	8	10	12	16

## Push-in connection terminal blocks

PIT 1,5/S..., PITTB 1,5/S...	3.5								
PIT 2,5..., PITTB 2,5..., PITS 2,5..., PITBS 2,5...	5								
PITI 2,5..., PITN 2,5...	5								
PIT 4..., PITTB 4..., PITME(D) 4...	6								
PITI 4..., PITN 4...	6								
PIT 6..., PITME(D) 6...	8								
PITI 6..., PITN 6...	8								

All PIT terminal blocks can also be labeled with the UniSheet material US-TM 100 in the central groove and US-TMF 100 in the lateral groove.

## Fast connection terminal blocks

QTC(U)(S) 1,5...,	5								
QTC(U)(S) 2,5...,	6								

## Bolt connection terminals

RT(O) 3...	12								
RT(O) 5...	16								
RT(O) 8...	20								
HV M.../1, HV M.../2	>13								
UHV 25-240	>26								

All terminal blocks can also be labeled with the UniSheet material US-TMF 100.

The pitch of the terminal block corresponds to the width of the label

The pitch of the terminal block is greater than the width of the label

# Terminal block marking for Phoenix Contact



	UCT-TMF 3,5	UCT-TMF 4	UCT-TMF 5	UCT-TMF 6	UCT-TMF 8	UCT-TMF 10	UCT-TMF 12	UCT-TMF 16	
	See page 19								
		TMT 4 R	TMT 5 R	TMT 6 R	TMT 8 R	TMT 10 R	TMT 100 R	TMT 100 R	
	See page 27								
Small terminal markers for central and external labeling	Pitch	3.5	4	5	6	8	10	12	16

## Push-in connection terminal blocks

PIT 1,5/S..., PITTB 1,5/S...	3.5								
PIT 2,5..., PITTB 2,5..., PITS 2,5..., PITBTS 2,5...	5								
PITI 2,5..., PITN 2,5...	5								
PIT 4..., PITTB 4..., PITME(D) 4...	6								
PITI 4..., PITN 4...	6								
PIT 6..., PITME(D) 6...	8								
PITI 6..., PITN 6...	8								

All PIT terminal blocks can also be labeled with the UniSheet material US-TM 100 in the central groove and US-TMF 100 in the lateral groove.

## Fast connection terminal blocks

QTC(U)(S) 1,5..., QTTCB(U)(S) 1,5...	5								
QTC(U)(S) 2,5...	6								

## Bolt connection terminals

RT(O) 3...	12								
RT(O) 5...	16								
RT(O) 8...	20								
HV M.../1, HV M.../2	>13								
UHV 25-240	>26								

## COMBI connectors

UPBV 2,5...	5								
UP 4..., UPBV 4...	6								
PP-H 1,5/S..., PPC 1,5/S...	3.5								
PP-H 2,5/...	5								
SP(V) 2,5..., SP(D)B 2,5..., SC 2,5...	5								
SP 4..., SC 4...	6								
DPB 1,5...	5								
QP 1,5...	5								

All terminal blocks can also be labeled with the UniSheet material US-TMF 100.

 The pitch of the terminal block corresponds to the width of the label

 The pitch of the terminal block is greater than the width of the label

## Terminal block marking for Weidmüller

					
		UCT1-TM 5	UCT1-TM 6	UCT1-TMF 5	UCT1-TMF 6
<b>Sheet, WH</b>		<b>0829482</b>	<b>0829483</b>	<b>0829237</b>	<b>0829243</b>
	Pitch	5	6	5	6
<b>Screw terminal blocks</b>					
AKZ 1,5/AKZ 2,5	5				
AKZ 4/AKE 4	6				
DLD(A)2,5.../MAK 2,5/VI 2,5	6				
SAK 10/16/35/95//EK 10/16/35	5				
SAK 2,5/4//EK 2,5/4	6				
SAKS.../SAK 6//EK 6	8				
WDK 2,5/4...	5				
WDL 2,5...	6				
WDT...	5				
WDU (WPE) 1,5/2,5...	5				
WDU (WPE) 4...	6				
WDU (WPE) 6-240...	8				
WF...	8				
WFF...	6				
WNT 2,5	5				
WNT 4	6				
WNT 6-WNT 70N	8				
WSI 4	6				
WSI 6	6				
WTL 4/6	6				
WTR 2,5...	5				
WTR 4...	6				

 The pitch of the terminal block corresponds to the width of the label

 The pitch of the terminal block is greater than the width of the label

## Terminal block marking for Weidmüller

					
		UCT1-TM 5	UCT1-TM 6	UCT1-TMF 5	UCT1-TMF 6
Sheet, WH		0829482	0829483	0829237	0829243
Pitch		5	6	5	6
<b>Spring-cage terminal blocks</b>					
ZDK 2,5 (PE).../ZDLD 2,5.../ZMAK 2,5	5				
ZDK 4 (PE)...	6				
ZDK 6/S	8				
ZDL 2,5/S.../ZDL 4/S...	5				
ZDT 2,5 (PE).../ZT (PE) 2,5.../ZP 2,5...	5				
ZDU (ZPE) 10...- ZDU (ZPE) 35/ZEI 16...	5				
ZDU (ZPE) 2,5...	5				
ZDU (ZPE) 4...	6				
ZDU (ZPE) 6.../ZEI 6	8				
ZNT 2,5/10/16/35...	5				
ZNT 4	6				
ZNT 6	8				
ZPV 1,5.../ZIA 1,5.../ZVL 1,5...	5				
ZSI 2,5.../ZSI 6...	5				
ZSI 6-2/FC	6				
ZT (PE) 4.../ZP 4...	6				
ZDT 6/ZTL 6	6				
ZTR 2,5.../ZDTR 2,5.../ZDL 2,5...	5				
<b>IDC terminal blocks</b>					
IDU (IPE 1,5) N.../ITR 1,5 N.../IDK 1,5 N (PE)...	5				
IDU (IPE) 2,5 N.../ITR 2,5 N...	6				
IT 1,5.../IEK 1,5 N (PE).../IAK 1,5 N.../IIK 1,5 N...	5				
<b>Push-in terminal blocks</b>					
PDL 4...	5				
PDU (PPE) 2,5/4.../PDK 2,5/4 (PE)...	5				
PDU (PPE) 6/10.../PDU (PPE) 16.../PEI 16...	8				
PNT 2,5/4	5				
PNT 6/10/16	8				

 The pitch of the terminal block corresponds to the width of the label

 The pitch of the terminal block is greater than the width of the label

## Terminal block marking for Wago

					
		UCT2-TM 5/6	UCT1-TMF 5	UCT1-TMF 5	UCT1-TMF 6
Sheet, WH		0829249	0829237	0829237	0829243
Pitch		5	5	5	6
<b>Spring-cage terminal blocks</b>					
2001...	4				
2002..., 2003...	5				
2004..., 2005..., 2006...	6				
2010..., 2016...	8				
261..., 264...	6				
270...	5				
279...	4				
280...	5				
280-8...	5				
281...	6				
282..., 283..., 284..., 285...	8				
290...	5				
727...	6				
769...	5				
775..., 776..., 777...	6				
780...	5				
781...	6				
782..., 783..., 784..., 785...	8				
869..., 870..., 880...	5				

All terminal blocks can also be labeled with the UniSheet material US2-TM 100.

 The pitch of the terminal block corresponds to the width of the label

 The pitch of the terminal block is greater than the width of the label

## Terminal block marking for Wieland

		  	
		UCT3-TM 5	UCT3-TM 6
Sheet, WH		0829251	0829252
Pitch		5	6
Screw terminal blocks			
9700 A/5...	5		
9700 A/6...	6		
9700 A/8...	8		
9700 A/10...	10		
9700 A/12...	12		
9700 A/16...	16		
9700 A/6 ETK...	6		
9700 A/8 ETK...	8		
9700 A/10 ETK...	10		
WK(M) 2,5...	5		
WK 4..., WKI 4..., WKM 4...	6		
WK 6...	8		
WKN 10..., WKI 10...	10		
WKN 16..., WKI 16...	12		
WKN 35..., WKI 35...	16		
WKN 70...	24		
WKN 150...	28		
9785 U/..., 9786 U/...	12		

 The pitch of the terminal block corresponds to the width of the label

 The pitch of the terminal block is greater than the width of the label

## Terminal block marking for Wieland

				
		UCT-TM 4	UCT3-TM 5	UCT3-TM 6
Sheet, WH		0828732	0829251	0829252
Pitch		4	5	6
<b>Spring-cage terminal blocks</b>				
WKF 1,5...	4			
WKF 1,5 KOI..., WKF 1,5 KOA...	5			
WK(I)F 2,5..., WKFN 2,5...	5			
WKF 4..., WKFN 4...	6			
WKF 6...	8			
WKF 10...	10			
WK(I)F 16...	12			
WKF 35...	16			
<b>Fast connection terminal blocks</b>				
WKC 1...	5			
WKC 2,5...	6			
WKF 16...WKC	12			

 The pitch of the terminal block corresponds to the width of the label

 The pitch of the terminal block is greater than the width of the label

## Terminal block marking for Conta-Clip

					
<b>Sheet, WH</b>		<b>0829482</b>	<b>0829483</b>	<b>0829237</b>	<b>0829243</b>
	Pitch	5	6	5	6

### Spring-cage terminal blocks

Z(S)RK 2,5..., ZSL 2,5...	5				
ZRK 4..., ZSL 4...	6				
ZRK (ZSL) 6..., ZRK (ZSL) 10..., ZRK (ZSL) 16...	8				
ZRKD 2,5..., ZSLD 2,5...	5				
ZIKD 2,5..., ZVMAK 2,5...	5				
ZTRK 2,5...	5				
ZIZA 1,5...	5				
ZS...	5				

### Push-in terminal blocks

FRK 1,5.../FSL 1,5...	4				
FRK 2,5.../FSL 2,5...	5				
FRK 4.../FSL 2,5...	6				
FRKD 2,5.../FSLD 2,5...	5				
FDLIS 2,5...	5				
FTRK 2,5...	5				
HSK...	8				

 The pitch of the terminal block corresponds to the width of the label

 The pitch of the terminal block is greater than the width of the label

## Terminal block marking for Conta-Clip

					
		UCT1-TM 5	UCT1-TM 6	UCT1-TMF 5	UCT1-TMF 6
Sheet, WH		0829482	0829483	0829237	0829243
Pitch		5	6	5	6
Screw terminal blocks					
RK 1,5-4...	6				
RK 2,5...	5				
RK 2,5-4...	6				
RK 6-10.../16.../35...	8				
RK 50...-RK 240...	8				
SL...	5				
RKD 2,5...	5				
RKD 4...	6				
DLI 2,5..., VMAK 2,5...	6				
IK (D) 2,5...	5				
TRK 1,5...	5				
TK.../STK...	8				
PTK...	8				
SIK 10...	8				
STK...	6				
SK...	8				
TSK 2,5	5				
FF.../SF...	6				
DLIS.../DLI...	6				
NT...	6				
RKA 2,5...	5				
RKA 4...	6				
RKA 10...	8				
RKB 4...	5				
KBL 2,5...	5				
KBL 2,5-4...	6				
KBL 6-10...	8				

 The pitch of the terminal block corresponds to the width of the label

 The pitch of the terminal block is greater than the width of the label

## Terminal block marking for Klemсан

					
		UCT1-TM 5	UCT1-TM 6	UCT1-TMF 5	UCT1-TMF 6
<b>Sheet, WH</b>		0829482	0829483	0829237	0829243
	Pitch	5	6	5	6

### Screw terminal blocks

AVK 2,5/PEK 2,5 K/WGT 2,5	5				
AVK 4.../AVK 2,5/4T/PEK 2,5/PEK 4/WGT 4	6				
AVK 6-240/PEK 6-35	8				
AVK 6/10T-16/35T//WGT 6/WGT 10	8				
PIK 2,5...	5				
PIK 4...	6				
PIK 3...	6				
ASK 2	8				
ASK 3	6				
ASK 4/AVK 4 FS	8				
ASK 4S/ASK 4 LD	6				
WGO...	8				
AYK 4...	6				
AYK 10...	8				
MVK 2,5 (T)	5				
MVK 4 (T)	6				

### Spring-cage terminal blocks

YBK 2,5 (T)	5				
YBK 4 (T)	6				
YBK 6 (T) (YBK 10 (T))	8				
MYK 2,5 (T).../MYPPK 2,5...	5				
YBK 2,5 F.../YBK 3...	5				
YBK 4...	6				
YBK S.../YBK I...	8				
YBK 2,5 A.../YBK 2,5 E.../YBK 2,5 C...	5				
PCY 2,5...	5				

 The pitch of the terminal block corresponds to the width of the label

 The pitch of the terminal block is greater than the width of the label

## Terminal block marking for Cabur

			
		UCT5-TM 5	UCT5-TM 6
Sheet, WH		0828750	0828752
Pitch		5	6
<b>Screw terminal blocks</b>			
AFO.2/1+2	6.5		
AFO.2/2+2	6.5		
CBC.2	5		
CBC.4	6		
CBC.6	8		
CBC.16	12		
CBC.35	16		
CBD.2	5.5		
CBD.4	6.5		
CBD.6	8		
CBD.10	10		
CBD.16	12		
CBD.35	16		
CBD.50	18		
CBD.70	20.5		
CBE.2	5		
CBR.2	5		
CVF.2	5		
CVF.4	6		
DAS.4	5		
DBC.2	5		
DSFA.4	6		
DSS.4	6		
EDM.2	5.5		
EDM.4	6.5		
EDM.6	8		
EDM.10	10		
EDM.16	12		
EDM.25	16		
EDM.35	18.5		
EDM.70	21		

 The pitch of the terminal block corresponds to the width of the label

 The pitch of the terminal block is greater than the width of the label

## Terminal block marking for Cabur

			
Sheet, WH		0828750	0828752
Pitch		5	6
<b>Screw terminal blocks</b>			
FDP.2	6.5		
FFS.4	6.5		
FPC.10	12		
FPL.10	12		
FVS.4	6.5		
GPA.70	20.5		
GPA.95	26		
GPA.150	31		
GPA.240	37		
MPPA.4	6		
MPS.2/SV	5.5		
MPS.2/SW	5.5		
MPS.2/SWP	5.5		
MPS.4	6		
PDF.2	6.5		
RN.2	5		
RP.4	6		
SCB.4	6.5		
SCB.6	8		
SFO.4	8		
SFR.4	8		
SFR.6	10		
SV.2	5.5		
SV.4	7		
SV.6	8		
SV.10	10.5		

 The pitch of the terminal block corresponds to the width of the label

 The pitch of the terminal block is greater than the width of the label

## Terminal block marking for Cabur

					
Sheet, WH		UCT5-TM 5	UCT5-TM 6		
		0828750	0828752		
Pitch		5	6		
<b>Screw terminal blocks</b>					
TE.6	8				
TE.10	10				
TE.16	12				
TE.35	16				
TEC.6	8				
TEC.10	10				
TEC.16	12				
TEC.35	16				
TEC.70	20.5				
TED.4	6.5				
TEO.2	5.5				
TEO.4	6.5				
TC/DIN	5.5				
TC/PO	5.5				
TDE.2	6				
TLD.2	6				
TLE.2	6				
TLS.2	6				
TR.2	5				
TR.4	7.3				
VPC.2	5				
VPD.2	5				
<b>Spring-cage terminal block</b>					
HCD.1	5.08				
<b>Push-in connection terminal blocks</b>					
NCS	6				
NCV	6				

 The pitch of the terminal block corresponds to the width of the label

 The pitch of the terminal block is greater than the width of the label

## Device marking for Phoenix Contact...



UCT-TM 3,5	UCT-TM 4 TMT 4 R	UCT-TM 5 TMT 5 R	UCT-TM 6 TMT 6 R	UCT-TM 16	UCT-TMF 5 TMT 5 R	UCT-TM 6 TMT 6 R	UCT-TMF 8 TMT 8 R	UCT-TMF 10 TMT 10 R	UCT-TMF 12	UCT-TMF 16	US-EMP (20 x 9)	EMT (62 x 10) R	EMT (62 x 46) R
------------	---------------------	---------------------	---------------------	-----------	----------------------	---------------------	----------------------	------------------------	------------	------------	-----------------	-----------------	-----------------

### INTERFACE

Sensor box with M12 slots PSR-SACB													
INTERFACE Relay PLC-B..., PLC-O..., PLC-R...													
Relay terminal block DEK-REL...													
Special relay DEK-OE...													
Inverter module DEK-TR...													
Compact-LINE UM45...													
PROCESS INTERFACE PI-EX...													

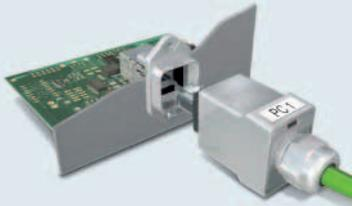

UCT-TM 3,5	UCT-TM 4 TMT 4 R	UCT-TM 5 TMT 5 R	UCT-TM 6 TMT 6 R	UCT-TM 16	UCT-TMF 5 TMT 5 R	UCT-TMF 6 TMT 6 R	UCT-TMF 8 TMT 8 R	UCT-TMF 10 TMT 10 R	UCT-TMF 12	UCT-TMF 16	US-EMP (20 x 9)	EMT (62 x 10) R	EMT (62 x 46) R
------------	---------------------	---------------------	---------------------	-----------	----------------------	----------------------	----------------------	------------------------	------------	------------	-----------------	-----------------	-----------------

### PLUSCON

SACB with M8 slots													
SACB with M12 slots													
SACB with M5 slots													
Sensor/actuator cabling accessories													
Data connector VS-SCRJ..., VS-IL-2X...													
AS interface distributor ASI CC DIST...													
Data front plate VS-SI...													
Modular contact insert HC-M...													
Heavy connector HEAVYCON HC-KA-B...													
Heavy connector HEAVYCON HC-KA-D...													

## Device marking for Phoenix Contact...



UCT-TM 3,5	UCT-TM 4 TMT 4 R	UCT-TM 5 TMT 5 R	UCT-TM 6 TMT 6 R	UCT-TM 16	UCT-TMF 5 TMT 5 R	CT-TMF 6 TMT 6 R	UCT-TMF8 TMT 8 R	UCT-TMF 10 TMT 10 R	UCT-TMF 12	UCT-TMF 16	US-EMP (20 x 9)	EMT (62 x 10) R	EMT (62 x 46) R
------------	---------------------	---------------------	---------------------	-----------	----------------------	---------------------	---------------------	------------------------	------------	------------	-----------------	-----------------	-----------------

### TRABTECH

Lightning arrester FLASHTRAB compact PLUS													
Lightning arrester FLASHTRAB PLUS													
Lightning arrester FLASHTRAB compact													
Surge arrester VALVETRAB compact													
Surge arrester VALVETRAB MS													
Device protection MAINS-PLUGTRAB													
Pluggable surge protection cascade PLUGTRAB PT...													
Modular terminal blocks with surge protection elements TT...													
Basic terminal blocks TT-PI...													



UCT-TM 3,5	UCT-TM 4 TMT 4 R	UCT-TM 5 TMT 5 R	UCT-TM 6 TMT 6 R	UCT-TM 16	UCT-TMF 5 TMT 5 R	UCT-TMF 6 TMT 6 R	UCT-TMF8 TMT 8 R	UCT-TMF 10 TMT 10 R	UCT-TMF 12	UCT-TMF 16	US-EMP (20 x 9)	EMT (62 x 10) R	EMT (62 x 46) R
------------	---------------------	---------------------	---------------------	-----------	----------------------	----------------------	---------------------	------------------------	------------	------------	-----------------	-----------------	-----------------

### AUTOMATION

Inline Modular													
Inline Block IO													
Interbus ST...													
Fieldline Stand-Alone M12													
Fieldline Modular M12													
Fieldline Modular M8													
Fieldline Extension M8													
Fieldline Wireless IO M12													

## UniSheet device marking for marker carriers from Phoenix Contact ...



US-EMP (17 x 15)	US-EMP (27 x 8)	US-EMP (27 x 12.5)	US-EMP (27 x 15)	US-EMP (27 x 18)	US-EMP (27 x 27)	US-EMP (49 x 15)	US-EMP (60 x 15)	US-EMP (60 x 30)	US-EMP (85.6 x 54)	US-EMLP (27 x 8)	US-EMLP (27 x 12.5)	US-EMLP (27 x 15)	US-EMLP (27 x 18)	US-EMLP (27 x 27)
------------------	-----------------	--------------------	------------------	------------------	------------------	------------------	------------------	------------------	--------------------	------------------	---------------------	-------------------	-------------------	-------------------

### Phoenix Contact

CARRIER-EMP 22 (27 x 8)		■												
CARRIER-EMP 22 (27 x 12.5)			■											
CARRIER-EMP 22 (27 x 15)				■										
CARRIER-EMP 22 (27 x 18)					■									
CARRIER-EMP 22 (27 x 27)						■								

CARRIER-EMP (17 x 15)	■													
CARRIER-EMP (27 x 15)			■											
CARRIER-EMP (49 x 15)						■								
CARRIER-EMP (60 x 15)							■							
CARRIER-EMP (60 x 30)								■						
CARRIER-EMP (85.6 x 54)									■					

CARRIER-EMLP 22 (27 x 8)										■				
CARRIER-EMLP 22 (27 x 12.5)											■			
CARRIER-EMLP 22 (27 x 15)												■		
CARRIER-EMLP 22 (27 x 18)													■	
CARRIER-EMLP 22 (27 x 27)														■

## Device marking for Siemens controllers



ET 200S  
S7-300

EMT (50/28 x 13) R...

EMT (50 x 26) R...

EMT (103 x 17) R...

EMT (103 x 23) R...

# Index

Type	Order No.	Page	Type	Order No.	Page
<b>A</b>			EML (100 x 90)R SR	0817141	32
			EML (100 x E)RL SR	0815787	33
			EML (101,6 x 25,4)RL SR	0815790	32
			EML (10 x 4)R	0815583	32
AK-DST/DIK	1000779	37	EML (10 x 7)R	0816663	32
AK-DST/UK	1000708	37	EML (10 x 7)R YE	0816676	32
			EML (15 x 9)R	0815677	32
			EML (15 x 9)R SR	0816032	32
			EML (15 x 9)R YE	0816045	32
			EML (16,5 x 5)R	0816702	32
			EML (16,5 x 5)R YE	0816728	32
			EML (16,5 x 5)RL	0816113	32
<b>C</b>			EML (16,5 x 5)RL YE	0816126	32
CARRIER-EMLP 22 (27 x 12,5)	0828985	41	EML (16 x 7)R	0818001	32
CARRIER-EMLP 22 (27 x 15)	0828986	41	EML (16 x 7)R YE	0816731	32
CARRIER-EMLP 22 (27 x 18)	0828987	41	EML (17,5 x 8)R	0816744	32
CARRIER-EMLP 22 (27 x 27)	0828988	41	EML (17,5 x 8)R YE	0816757	32
CARRIER-EMLP 22 (27 x 8)	0828984	41	EML (17,5 x 8)RL YE	0816139	32
CARRIER-EMP (1000 x 15) COVER	0829520	41	EML (19 x 6)R	0816760	32
CARRIER-EMP (1000 x 15) GY	0829366	41	EML (20 x 7)R YE	0816773	32
CARRIER-EMP (1000 x 15) TR	0829530	41	EML (20 x 8)R	0816786	32
CARRIER-EMP (17 x 15)	0827450	41	EML (20 x 8)R YE	0816799	32
CARRIER-EMP (27 x 15)	0827451	41	EML (21,5 x 21,5)R SR	0816812	32
CARRIER-EMP (49 x 15)	0827452	41	EML (25,4 x 12,7)R	0816825	32
CARRIER-EMP (60 x 15)	0827453	41	EML (25,4 x 12,7)R YE	0816838	32
CARRIER-EMP (60 x 30)	0827454	41	EML (26,5 x 12)R SR	0816854	32
CARRIER-EMP (85,6 x 54)	0829365	41	EML (26,5 x 17,5)R SR	0816883	32
CARRIER-EMP 22 (27 x 12,5)	0827446	41	EML (26,5 x 17,5)R YE	0816896	32
CARRIER-EMP 22 (27 x 15)	0827447	41	EML (26,5 x 18,5)R SR	0816906	32
CARRIER-EMP 22 (27 x 18)	0827448	41	EML (26,5 x 26,5)R SR	0816919	32
CARRIER-EMP 22 (27 x 27)	0827449	41	EML (26,5 x 7,5)R SR	0816841	32
CARRIER-EMP 22 (27 x 8)	0827445	41	EML (30 x 20)R	0816922	32
CARRIER/L-EMP (1000 x 15) GY	0829559	41	EML (30 x 20)R YE	0816935	32
CARRIER/L-EMP (1000 x 15) TR	0829560	41	EML (32 x 25)R YE	0800020	32
CLIP-PROJECT ADVANCED	5146040	8	EML (37 x E)RL TR	0815716	33
CLIP-PROJECT PROFESSIONAL	5146053	8	EML (38,1 x 19)RL	0816171	32
			EML (38 x 17)R	0816951	32
			EML (40 x 15)R SR	0815729	32
			EML (40 x 25)R	0818027	32
			EML (40 x 25)R YE	0816977	32
<b>E</b>			EML (40 x 8)R	0816980	32
EML (100 x 73)R	0817125	32	EML (50,8 x 25,4)RL	0816184	32
EML (100 x 73)R SR	0817112	32	EML (51 x 12,5)R TR	0815745	32
EML (100 x 73)R YE	0817138	32	EML (51 x 25)R	0817028	32
EML (100 x 90)R	0817154	32			

## Index

Type	Order No.	Page	Type	Order No.	Page
EML (51 x 25)R SR	0817002	32	EMLP (27 x 27)R SR	0827467	34
EML (51 x 25)R YE	0817031	32	EMLP (27 x 8)R SR	0819518	34
EML (69,8 x 31,8)RL	0816197	32	EMLP (45 x 15)R SR	0819547	34
EML (70 x 32)R	0817060	32	EMLP 24 (30 x 12)R	0819550	34
EML (70 x 32)R SR	0817057	32	EMLP 24 (30 x 12)R SR	0819563	34
EML (70 x 32)R YE	0817073	32	EMLPR (100 x 30)	0800362	36
EML (70 x 50)R	0817099	32	EMLPR (26,5 x 14,5)	0800546	36
EML (70 x 50)R SR	0817086	32	EMLPR (26,5 x 17,5)	0800360	36
EML (76,2 x 6,5)RL YE	0816207	32	EMLPR (26,5 x 26,5)	0800361	36
EML (90 x 5)R	0817109	32	EMLPR (30 x 40)	0800359	36
EML (D17,5)R	0815774	33	EMLPR (80 x 42)	0800357	36
EML (100 x 40)R	0800286	32	EMLPR (80 x 60)	0800358	36
EML (15 x 6) R YE	0819288	32	EMLS (15 x 9)R SR	0800347	35
EML (18 x 6)RL YE	0828460	32	EMLS (19 x 6)R SR	0800343	35
EML (24 x 4)R	0800061	32	EMLS (20 x 20)R SR	0800344	35
EML (25,4 x 12,7)RL	0816087	32	EMLS (26,5 x 12)R SR	0800353	35
EMLC (15 x 9)R YE	0800236	33	EMLS (38,1 x 19)R SR	0800354	35
EMLC (17,5 x 8)R YE	0800237	33	EMLS (40 x 15)R SR	0800345	35
EMLC (20 x 8)R YE	0800235	33	EMLS (40 x 8)R SR	0800348	35
EMLC (25,4 x 12,7)R YE	0800238	33	EMLS (60 x 30)R SR	0800355	35
EMLC (25 x 8)R YE	0800240	33	EMLS (70 x 150)R SR	0800351	35
EMLC (38 x 17)R YE	0800557	33	EMLS (70 x 32)R SR	0800346	35
EMLC (40 x 8)R	0800554	33	EMLS (76 x 51)R SR	0800350	35
EMLC (40 x 8)R YE	0800555	33	EMLS (85 x 32)R SR	0800356	35
EMLC (51 x 25)R YE	0800558	33	EMPPR (27 x 15)	0829535	36
EMLF (108 x E)R	0800549	33	EMPPR (27 x 18)	0829536	36
EMLF (108 x E)R SR	0800551	33	EMT (10 x 4)R	0816235	28
EMLF (108 x E)R TR	0800552	33	EMT (15 x 4)R	0817329	28
EMLF (108 x E)R YE	0800550	33	EMT (15 x 4)R BU	0817332	28
EMLHT (15 x 15)R	0800341	33	EMT (15 x 4)R RD	0816249	28
EMLHT (40 x 15)R	0800339	33	EMT (15 x 4)R YE	0817358	28
EMLHT (45 x 5)R	0800337	33	EMT (23 x 4)R	0817361	28
EMLHT (50 x 10)R	0800338	33	EMT (23 x 4)R YE	0817374	28
EMLHT(D12)R	0801376	33	EMT (24 x 4)R	0816265	28
EMLHT (8 x 8)R	0800340	33	EMT (25 x 6)R	0817264	28
EMLP (13 x 9)R	0819453	34	EMT (29 x 8)R	0817277	28
EMLP (17,5 x 12)R	0819466	34	EMT (29 x 8)R YE	0817280	28
EMLP (17 x 7)R	0826844	34	EMT (40 x 17)R	0817293	28
EMLP (20 x 7)R	0819479	34	EMT (103 x 17)R	0800039	35
EMLP (20 x 8)R	0819482	34	EMT (103 x 17)R TQ	0800041	35
EMLP (22 x 12)R	0819495	34	EMT (103 x 17)R YE	0800436	35
EMLP (22 x 22)R SR	0825528	34	EMT (103 x 23)R	0800040	35
EMLP (27 x 12,5)R SR	0819521	34	EMT (103 x 23)R YE	0800437	35
EMLP (27 x 18)R SR	0819534	34	EMT (44 x 7)R	0819275	28



# Index

Type	Order No.	Page	Type	Order No.	Page
PATG 5/23	0808024	39	THERMOMARK CARD-UCT-MAG2	5146563	6
PATG 5/30	0822482	39	THERMOMARK CARD-UCT-MAG3	5146613	6
PATG 6/15	1013070	39	THERMOMARK CARD-UCT-MAG4	5146614	6
PATG 6/18	0828062	39	THERMOMARK CARD-UCT-MAG5	5146615	6
PATG 6/23	0808037	39	THERMOMARK CARD-UCT-MAG6	5146616	6
PKB 100 x 2,5	1005457	38	THERMOMARK CARD-US-MAG1	5146451	6
PKB 100 x 2,5 BK	1005512	38	THERMOMARK ROLL	5146477	7
PKB 140 x 3,6	1005460	38	THERMOMARK ROLL SET	5147300	7
PKB 140 x 3,6 BK	1005525	38	THERMOMARK ROLL SET EN	5147301	7
PKB 190 x 4,8	1005473	38	THERMOMARK ROLL-CUTTER	5146422	7
PKB 190 x 4,8 BK	1005538	38	THERMOMARK ROLL-CUTTER/P	5146435	7
PKB 200 x 2,5	1005486	38	THERMOMARK ROLL-ERH	5146448	7
PKB 200 x 2,5 BK	1005541	38	THERMOMARK-ERH 500	5146309	7
PKB 290 x 4,8	1005499	38	THERMOMARK-RIBBON 110	5145384	7
PKB 290 x 4,8 BK	1005554	38	THERMOMARK-RIBBON 110 BU	0829544	7
PKB 370 x 4,8	1005509	38	THERMOMARK-RIBBON 110 GN	0829542	7
PKB 370 x 4,8 BK	1005567	38	THERMOMARK-RIBBON 110 RD	0829543	7
			THERMOMARK-RIBBON 110-EMLHT	0800342	7
			THERMOMARK-RIBBON 110-TC	0801371	6
			THERMOMARK-RIBBON 110-WMSU	0801358	7
			THERMOMARK-RIBBON 110-WMSU WH	0801359	7
			TL CASE	0800613	6
			TML (101 x 4,2)R TR	0816621	27
			TML (101 x 9,5)R TR	0816647	27
			TML (E x 4,2)R TR	0816715	27
			TML (E x 9,5)R TR	0816634	27
			TMT 4 R	0816375	27
			TMT 4 R BU	0816333	27
			TMT 4 R GN	0816346	27
			TMT 4 R OG	0816359	27
			TMT 4 R RD	0816362	27
			TMT 4 R YE	0816388	27
			TMT 5 R	0816430	27
			TMT 5 R BU	0816391	27
			TMT 5 R GN	0816401	27
			TMT 5 R OG	0816414	27
			TMT 5 R RD	0816427	27
			TMT 5 R YE	0816443	27
			TMT 6 R	0816498	27
			TMT 6 R BU	0816456	27
			TMT 6 R GN	0816469	27
			TMT 6 R OG	0816472	27
			TMT 6 R RD	0816485	27
			TMT 6 R YE	0816508	27
<b>S</b>					
SK 2,8 WH:REEL	0805205	27			
SK 3,8 WH:REEL	0805218	27			
SK 5,0 WH:REEL	0805221	27			
SK 10,0 WH:REEL	0812188	27			
STP 3,5-2	0830131	37			
STP 3,5-3	0830132	37			
STP 4-2	0810575	37			
STP 4-2-ZB	3038613	37			
STP 5-2	0800967	37			
STP 5-2-ZB	3037643	37			
STP 5-2/S	0800970	37			
STP 5-3	0810562	37			
<b>T</b>					
THERMOMARK CARD	5146464	6			
THERMOMARK CARD SET	5147200	6			
THERMOMARK CARD SET EN	5147201	6			
THERMOMARK CARD-UCT-MAG1	5146480	6			

# Index

Type	Order No.	Page	Type	Order No.	Page
TMT 8 R	0816553	27	UCT-TM 3,5 GN	0829509	19
TMT 8 R BU	0816511	27	UCT-TM 3,5 OG	0829506	19
TMT 8 R GN	0816524	27	UCT-TM 3,5 RD	0829505	19
TMT 8 R OG	0816537	27	UCT-TM 3,5 VT	0829507	19
TMT 8 R RD	0816540	27	UCT-TM 4	0828732	19
TMT 8 R YE	0816566	27	UCT-TM 4 BU	0829152	19
TMT 10 R	0816210	27	UCT-TM 4 GN	0829153	19
TMT 100 R	0816605	27	UCT-TM 4 OG	0829150	19
TMT 100 R BU	0816223	27	UCT-TM 4 RD	0829149	19
TMT 100 R GN	0816579	27	UCT-TM 4 VT	0829151	19
TMT 100 R OG	0816582	27	UCT-TM 4 YE	0828733	19
TMT 100 R RD	0816595	27	UCT-TM 5	0828734	19
TMT 100 R YE	0816618	27	UCT-TM 5 BU	0829157	19
TMT TOOL	0816650	27	UCT-TM 5 GN	0829158	19
			UCT-TM 5 OG	0829155	19
			UCT-TM 5 RD	0829154	19
			UCT-TM 5 VT	0829156	19
			UCT-TM 5 YE	0828735	19
			UCT-TM 6	0828736	19
			UCT-TM 6 BU	0829162	19
			UCT-TM 6 GN	0829163	19
			UCT-TM 6 OG	0829160	19
			UCT-TM 6 RD	0829159	19
			UCT-TM 6 VT	0829161	19
			UCT-TM 6 YE	0828737	19
			UCT-TM 7,62	0828738	19
			UCT-TM 7,62 BU	0829513	19
			UCT-TM 7,62 GN	0829514	19
			UCT-TM 7,62 OG	0829511	19
			UCT-TM 7,62 RD	0829510	19
			UCT-TM 7,62 VT	0829512	19
			UCT-TM 8	0828740	19
			UCT-TM 8 BU	0829167	19
			UCT-TM 8 GN	0829168	19
			UCT-TM 8 OG	0829165	19
			UCT-TM 8 RD	0829164	19
			UCT-TM 8 VT	0829166	19
			UCT-TM 8 YE	0828741	19
			UCT-TMF 10	0829204	19
			UCT-TMF 10 BU	0829209	19
			UCT-TMF 10 GN	0829210	19
			UCT-TMF 10 OG	0829206	19
			UCT-TMF 10 RD	0829205	19
			UCT-TMF 10 VT	0829208	19
			UCT-TMF 10 YE		
			UCT-TM 3,5		
			UCT-TM 3,5 BU		

## U

UBE	0800310	37	UCT-TM 6 GN	0829163	19
UBE/D	0800307	37	UCT-TM 6 OG	0829160	19
UCT-TM 10	0829142	19	UCT-TM 6 RD	0829159	19
UCT-TM 10 BU	0829172	19	UCT-TM 6 VT	0829161	19
UCT-TM 10 GN	0829173	19	UCT-TM 6 YE	0828737	19
UCT-TM 10 OG	0829170	19	UCT-TM 7,62	0828738	19
UCT-TM 10 RD	0829169	19	UCT-TM 7,62 BU	0829513	19
UCT-TM 10 VT	0829171	19	UCT-TM 7,62 GN	0829514	19
UCT-TM 10 YE	0829143	19	UCT-TM 7,62 OG	0829511	19
UCT-TM 12	0829144	19	UCT-TM 7,62 RD	0829510	19
UCT-TM 12 BU	0829177	19	UCT-TM 7,62 VT	0829512	19
UCT-TM 12 GN	0829178	19	UCT-TM 8	0828740	19
UCT-TM 12 OG	0829175	19	UCT-TM 8 BU	0829167	19
UCT-TM 12 RD	0829174	19	UCT-TM 8 GN	0829168	19
UCT-TM 12 VT	0829176	19	UCT-TM 8 OG	0829165	19
UCT-TM 12 YE	0829145	19	UCT-TM 8 RD	0829164	19
UCT-TM 16	0829146	19	UCT-TM 8 VT	0829166	19
UCT-TM 16 BU	0829182	19	UCT-TM 8 YE	0828741	19
UCT-TM 16 GN	0829183	19	UCT-TMF 10	0829204	19
UCT-TM 16 OG	0829180	19	UCT-TMF 10 BU	0829209	19
UCT-TM 16 RD	0829179	19	UCT-TMF 10 GN	0829210	19
UCT-TM 16 YE	0829147	19	UCT-TMF 10 OG	0829206	19
UCT-TM 3,5	0829484	19	UCT-TMF 10 RD	0829205	19
UCT-TM 3,5 BU	0829508	19	UCT-TMF 10 VT	0829208	19

## Index

Type	Order No.	Page	Type	Order No.	Page
UCT-TMF 10 YE	0829207	19	UCT-TMF 8 RD	0829199	19
UCT-TMF 12	0829214	19	UCT-TMF 8 VT	0829201	19
UCT-TMF 12 BU	0829216	19	UCT-TMF 8 YE	0828749	19
UCT-TMF 12 GN	0829217	19	UCT-WMS 3,2 (12 x 4)	0828570	22
UCT-TMF 12 OG	0829213	19	UCT-WMS 3,2 (12 x 4) YE	0828572	22
UCT-TMF 12 RD	0829212	19	UCT-WMS 4,7 (12 x 5,5)	0828571	22
UCT-TMF 12 VT	0829215	19	UCT-WMS 4,7 (12 x 5,5) YE	0828573	22
UCT-TMF 12 YE	0829211	19	UCT1-TM 5	0829482	20
UCT-TMF 16	0829218	19	UCT1-TM 5 BU	0829229	20
UCT-TMF 16 BU	0829223	19	UCT1-TM 5 GN	0829230	20
UCT-TMF 16 GN	0829224	19	UCT1-TM 5 OG	0829227	20
UCT-TMF 16 OG	0829220	19	UCT1-TM 5 RD	0829226	20
UCT-TMF 16 RD	0829219	19	UCT1-TM 5 YE	0829228	20
UCT-TMF 16 YE	0829221	19	UCT1-TM 6	0829483	20
UCT-TMF 3,5	0829486	19	UCT1-TM 6 BU	0829235	20
UCT-TMF 3,5 BU	0829518	19	UCT1-TM 6 GN	0829236	20
UCT-TMF 3,5 GN	0829519	19	UCT1-TM 6 OG	0829233	20
UCT-TMF 3,5 RD	0829515	19	UCT1-TM 6 RD	0829232	20
UCT-TMF 3,5 VT	0829517	19	UCT1-TM 6 YE	0829234	20
UCT-TMF 3,5 YE	0829487	19	UCT1-TMF 5	0829237	20
UCT-TMF 4	0828742	19	UCT1-TMF 5 BU	0829241	20
UCT-TMF 4 BU	0829187	19	UCT1-TMF 5 GN	0829242	20
UCT-TMF 4 GN	0829188	19	UCT1-TMF 5 OG	0829239	20
UCT-TMF 4 OG	0829185	19	UCT1-TMF 5 RD	0829238	20
UCT-TMF 4 RD	0829184	19	UCT1-TMF 5 YE	0829240	20
UCT-TMF 4 VT	0829186	19	UCT1-TMF 6	0829243	20
UCT-TMF 4 YE	0828743	19	UCT1-TMF 6 BU	0829247	20
UCT-TMF 5	0828744	19	UCT1-TMF 6 GN	0829248	20
UCT-TMF 5 BU	0829192	19	UCT1-TMF 6 OG	0829245	20
UCT-TMF 5 GN	0829193	19	UCT1-TMF 6 RD	0829244	20
UCT-TMF 5 RD	0829189	19	UCT1-TMF 6 YE	0829246	20
UCT-TMF 5 VT	0829191	19	UCT2-TM 5/6	0829249	21
UCT-TMF 5 YE	0828745	19	UCT3-TM 5	0829251	21
UCT-TMF 6	0828746	19	UCT3-TM 6	0829252	21
UCT-TMF 6 BU	0829197	19	UCT5-TM 5	0828750	21
UCT-TMF 6 GN	0829198	19	UCT5-TM 6	0828752	21
UCT-TMF 6 OG	0829195	19	US-EML (104 x 140)	0800465	25
UCT-TMF 6 RD	0829194	19	US-EML (104 x 140) SR	0800466	25
UCT-TMF 6 VT	0829196	19	US-EML (104 x 140) YE	0800467	25
UCT-TMF 6 YE	0828747	19	US-EML (104 x 3,8)	0800464	25
UCT-TMF 8	0828748	19	US-EML (17,5 x 8)	0800461	25
UCT-TMF 8 BU	0829202	19	US-EML (17,5 x 8) YE	0800463	25
UCT-TMF 8 GN	0829203	19	US-EML (20 x 8)	0800458	25
UCT-TMF 8 OG	0829200	19	US-EML (20 x 8) YE	0800460	25

## Index

Type	Order No.	Page	Type	Order No.	Page
US-EMLC (20 x 8)	0800468	25	US-EMLP (49 x 15) SR	0828902	25
US-EMLC (20 x 8) YE	0800469	25	US-EMLP (49 x 15) YE	0828901	25
US-EMLC (40 x 8)	0800470	25	US-EMLP (60 x 15)	0828804	25
US-EMLC (40 x 8) YE	0800471	25	US-EMLP (60 x 15) SR	0828904	25
US-EMLP (100 x 60)	0828807	25	US-EMLP (60 x 15) YE	0828903	25
US-EMLP (100 x 60) SR	0828910	25	US-EMLP (60 x 30)	0828805	25
US-EMLP (100 x 60) YE	0828909	25	US-EMLP (60 x 30) SR	0828906	25
US-EMLP (11 x 9)	0828789	25	US-EMLP (60 x 30) YE	0828905	25
US-EMLP (11 x 9) SR	0828872	25	US-EMLP (85,6 x 54)	0828806	25
US-EMLP (11 x 9) YE	0828871	25	US-EMLP (85,6 x 54) SR	0828908	25
US-EMLP (15 x 5)	0828790	25	US-EMLP (85,6 x 54) YE	0828907	25
US-EMLP (15 x 5) SR	0828874	25	US-EMP (100 x 15)	0829521	24
US-EMLP (15 x 5) YE	0828873	25	US-EMP (100 x 15) SR	0829523	24
US-EMLP (17 x 15)	0828793	25	US-EMP (100 x 15) YE	0829522	24
US-EMLP (17 x 15) SR	0828880	25	US-EMP (17 x 15)	0828774	24
US-EMLP (17 x 15) YE	0828879	25	US-EMP (17 x 15) SR	0828843	24
US-EMLP (17 x 7)	0828792	25	US-EMP (20 x 9)	0829439	24
US-EMLP (17 x 7) SR	0828878	25	US-EMP (25 x 6)	0829435	24
US-EMLP (17 x 7) YE	0828877	25	US-EMP (27 x 12,5)	0828776	24
US-EMLP (20 x 9)	0828795	25	US-EMP (27 x 12,5) SR	0828847	24
US-EMLP (20 x 9) SR	0828884	25	US-EMP (27 x 12,5) YE	0828846	24
US-EMLP (20 x 9) YE	0828883	25	US-EMP (27 x 15)	0828777	24
US-EMLP (22 x 22)	0828796	25	US-EMP (27 x 15) SR	0828849	24
US-EMLP (22 x 22) SR	0828886	25	US-EMP (27 x 15) YE	0828848	24
US-EMLP (22 x 22) YE	0828885	25	US-EMP (27 x 18)	0828778	24
US-EMLP (27 x 12,5)	0828798	25	US-EMP (27 x 18) SR	0828851	24
US-EMLP (27 x 12,5) SR	0828892	25	US-EMP (27 x 18) YE	0828850	24
US-EMLP (27 x 12,5) YE	0828891	25	US-EMP (27 x 27)	0828779	24
US-EMLP (27 x 15)	0828799	25	US-EMP (27 x 27) SR	0828853	24
US-EMLP (27 x 15) SR	0828894	25	US-EMP (27 x 27) YE	0828852	24
US-EMLP (27 x 15) YE	0828893	25	US-EMP (27 x 8)	0828775	24
US-EMLP (27 x 18)	0828800	25	US-EMP (27 x 8) SR	0828845	24
US-EMLP (27 x 18) SR	0828896	25	US-EMP (27 x 8) YE	0828844	24
US-EMLP (27 x 18) YE	0828895	25	US-EMP (29 x 8)	0829436	24
US-EMLP (27 x 27)	0828801	25	US-EMP (29 x 8) YE	0829440	24
US-EMLP (27 x 27) SR	0828898	25	US-EMP (40 x 17)	0829437	24
US-EMLP (27 x 27) YE	0828897	25	US-EMP (44 x 7)	0829438	24
US-EMLP (27 x 8)	0828797	25	US-EMP (49 x 15)	0828780	24
US-EMLP (27 x 8) SR	0828890	25	US-EMP (49 x 15) YE	0828854	24
US-EMLP (27 x 8) YE	0828889	25	US-EMP (60 x 15)	0828781	24
US-EMLP (35 x 9)	0828802	25	US-EMP (60 x 15) SR	0828857	24
US-EMLP (35 x 9) SR	0829430	25	US-EMP (60 x 15) YE	0828856	24
US-EMLP (35 x 9) YE	0828899	25	US-EMP (60 x 30)	0828782	24
US-EMLP (49 x 15)	0828803	25	US-EMP (60 x 30) SR	0828859	24

## Index

Type	Order No.	Page	Type	Order No.	Page
US-EMP (60 x 30) YE	0828858	24	US-WMT (18 x 4) VT	0829297	22
US-EMP (85,6 x 54)	0828783	24	US-WMT (18 x 4) YE	0828955	22
US-EMP (85,6 x 54) SR	0828861	24	US-WMT (23 x 4)	0828769	22
US-EMP (85,6 x 54) YE	0828860	24	US-WMT (23 x 4) BU	0829305	22
US-EMSP (50 x 30)	0828786	24	US-WMT (23 x 4) GN	0829306	22
US-EMSP (50 x 30) SR	0828928	24	US-WMT (23 x 4) OG	0829302	22
US-EMSP (50 x 30) YE	0828927	24	US-WMT (23 x 4) RD	0829301	22
US-EMSP (75,6 x 54)	0828787	24	US-WMT (23 x 4) VT	0829304	22
US-EMSP (75,6 x 54) SR	0828930	24	US-WMT (23 x 4) YE	0828956	22
US-EMSP (75,6 x 54) YE	0828929	24	US-WMT (30 x 4)	0828770	22
US-EMSP (90 x 60)	0828788	24	US-WMT (30 x 4) BU	0829312	22
US-EMSP (90 x 60) SR	0828932	24	US-WMT (30 x 4) GN	0829313	22
US-EMSP (90 x 60) YE	0828931	24	US-WMT (30 x 4) OG	0829309	22
US-TM 100	0829255	20	US-WMT (30 x 4) RD	0829308	22
US-TMF 100	0829260	20	US-WMT (30 x 4) VT	0829311	22
US-WML 14 (25 x 19)	0800473	23	US-WMT (30 x 4) YE	0828957	22
US-WML 36 (25 x 25)	0800474	23	US-WMTB (24 x 5)	0828771	23
US-WML 6 (13 x 13)	0800472	23	US-WMTB (24 x 5) BU	0829324	23
US-WMT (10 x 4)	0828765	22	US-WMTB (24 x 5) GN	0829325	23
US-WMT (10 x 4) BU	0829277	22	US-WMTB (24 x 5) OG	0829321	23
US-WMT (10 x 4) GN	0829278	22	US-WMTB (24 x 5) RD	0829320	23
US-WMT (10 x 4) OG	0829274	22	US-WMTB (24 x 5) VT	0829323	23
US-WMT (10 x 4) RD	0829273	22	US-WMTB (24 x 5) YE	0828958	23
US-WMT (10 x 4) VT	0829276	22	US-WMTB (29 x 8)	0828772	23
US-WMT (10 x 4) YE	0828952	22	US-WMTB (29 x 8) BU	0829331	23
US-WMT (12 x 4)	0828766	22	US-WMTB (29 x 8) GN	0829332	23
US-WMT (12 x 4) BU	0829284	22	US-WMTB (29 x 8) OG	0829328	23
US-WMT (12 x 4) GN	0829285	22	US-WMTB (29 x 8) RD	0829327	23
US-WMT (12 x 4) OG	0829281	22	US-WMTB (29 x 8) VT	0829330	23
US-WMT (12 x 4) RD	0829280	22	US-WMTB (29 x 8) YE	0828959	23
US-WMT (12 x 4) VT	0829283	22	US-WMTB (44 x 15)	0828773	23
US-WMT (12 x 4) YE	0828953	22	US-WMTB (44 x 15) BU	0829338	23
US-WMT (15 x 4)	0828767	22	US-WMTB (44 x 15) GN	0829339	23
US-WMT (15 x 4) BU	0829291	22	US-WMTB (44 x 15) OG	0829335	23
US-WMT (15 x 4) GN	0829292	22	US-WMTB (44 x 15) RD	0829334	23
US-WMT (15 x 4) OG	0829288	22	US-WMTB (44 x 15) VT	0829337	23
US-WMT (15 x 4) RD	0829287	22	US-WMTB (44 x 15) YE	0828960	23
US-WMT (15 x 4) VT	0829290	22	US2-TM 100	0829268	21
US-WMT (15 x 4) YE	0828954	22			
US-WMT (18 x 4)	0828768	22			
US-WMT (18 x 4) BU	0829298	22			
US-WMT (18 x 4) GN	0829299	22			
US-WMT (18 x 4) OG	0829295	22			
US-WMT (18 x 4) RD	0829294	22			

## Index

Type	Order No.	Page	Type	Order No.	Page
<b>W</b>					
WML 5 (25 x 10)R	0817523	28	WMS 3,2 (60 x 5)R YE	0800399	30
WML 6 (13 x 13)R	0816252	28	WMS 3,2 (60 x 5)RL	0800384	30
WML 7,5 (17 x 9)R	0828444	28	WMS 38,1 (60 x 60)R	0800372	30
WML 14 (25 x 19)R	0817536	28	WMS 38,1 (60 x 60)R YE	0800406	30
WML 14 (25 x 19)R YE	0817549	28	WMS 6,4 (30 x 10)R	0800376	30
WML 14 (38 x 19)R	0817552	28	WMS 6,4 (30 x 10)R YE	0800410	30
WML 18 (12 x 12)R	0817507	28	WMS 6,4 (60 x 10)R	0800367	30
WML 20 (31 x 25)R	0828457	28	WMS 6,4 (60 x 10)R YE	0800401	30
WML 3 (13 x 10)R	0800073	28	WMS 9,5 (30 x 16)R	0800377	30
WML 36 (25 x 38)R	0817510	28	WMS 9,5 (30 x 16)R YE	0800411	30
WML 7,5 (13 x 13)R	0800074	28	WMS 9,5 (60 x 16)R	0800368	30
WML 7,5 (25 x 13)R	0800075	28	WMS 9,5 (60 x 16)R YE	0800402	30
WML 12 (25 x 19)R	0800076	28	WMS 12,7 (E x 20)R	0800294	31
WML 22 (25 x 25)R	0800078	28	WMS 12,7 (E x 20)R BK	0800422	31
WML 46 (25 x 38)R	0800067	28	WMS 12,7 (E x 20)R YE	0800305	31
WMS 12,7 (60 x 20)R	0800369	30	WMS 12,7 (E x 20)RL	0800325	31
WMS 12,7 (60 x 20)R YE	0800403	30	WMS 12,7 (E x 20)RL BK	0800432	31
WMS 19,1 (60 x 30)R	0800370	30	WMS 12,7 (E x 20)RL YE	0800333	31
WMS 19,1 (60 x 30)R YE	0800404	30	WMS 19,1 (E x 30)R	0800295	31
WMS 2,4 (15 x 4)R	0800379	30	WMS 19,1 (E x 30)R BK	0800423	31
WMS 2,4 (15 x 4)R YE	0800412	30	WMS 19,1 (E x 30)R YE	0800306	31
WMS 2,4 (15 x 4)RL	0800389	30	WMS 19,1 (E x 30)RL	0800326	31
WMS 2,4 (15 x 4)RXL	0800396	30	WMS 19,1 (E x 30)RL BK	0800434	31
WMS 2,4 (30 x 4)R	0800373	30	WMS 19,1 (E x 30)RL YE	0800334	31
WMS 2,4 (30 x 4)R YE	0800407	30	WMS 2,4 (E x 4)R	0800289	31
WMS 2,4 (30 x 4)RL	0800386	30	WMS 2,4 (E x 4)R BK	0800415	31
WMS 2,4 (30 x 4)RXL	0800394	30	WMS 2,4 (E x 4)R YE	0800300	31
WMS 2,4 (60 x 4)R	0800363	30	WMS 2,4 (E x 4)RL	0800319	31
WMS 2,4 (60 x 4)R YE	0800398	30	WMS 2,4 (E x 4)RL BK	0800427	31
WMS 2,4 (60 x 4)RL	0800383	30	WMS 2,4 (E x 4)RL YE	0800328	31
WMS 2,4 (60 x 4)RXL	0800392	30	WMS 25,4 (E x 40)R	0800296	31
WMS 25,4 (60 x 40)R	0800371	30	WMS 25,4 (E x 40)R BK	0800424	31
WMS 25,4 (60 x 40)R YE	0800405	30	WMS 25,4 (E x 40)R YE	0800308	31
WMS 3,2 (15 x 5)R	0800380	30	WMS 25,4 (E x 40)RL	0800327	31
WMS 3,2 (15 x 5)R YE	0800413	30	WMS 25,4 (E x 40)RL BK	0800435	31
WMS 3,2 (15 x 5)RL	0800390	30	WMS 25,4 (E x 40)RL YE	0800335	31
WMS 3,2 (30 x 5)R	0800374	30	WMS 3,2 (E x 5)R	0800290	31
WMS 3,2 (30 x 5)R YE	0800408	30	WMS 3,2 (E x 5)R BK	0800416	31
WMS 3,2 (30 x 5)RL	0800387	30	WMS 3,2 (E x 5)R YE	0800301	31
WMS 3,2 (60 x 5)R	0800364	30	WMS 3,2 (E x 5)RL	0800320	31
			WMS 3,2 (E x 5)RL BK	0800428	31
			WMS 3,2 (E x 5)RL YE	0800329	31
			WMS 38,1 (E x 60)R	0800298	31
			WMS 38,1 (E x 60)R BK	0800425	31

## Index

Type	Order No.	Page	Type	Order No.	Page
WMS 38,1 (E x 60)R YE	0800309	31			
WMS 4,8 (15 x 9)R	0800382	30			
WMS 4,8 (15 x 9)R YE	0800414	30			
WMS 4,8 (15 x 9)RL	0800391	30			
WMS 4,8 (15 x 9)RXL	0800397	30			
WMS 4,8 (30 x 9)R	0800375	30			
WMS 4,8 (30 x 9)R YE	0800409	30			
WMS 4,8 (30 x 9)RL	0800388	30			
WMS 4,8 (30 x 9)RXL	0800395	30			
WMS 4,8 (60 x 9)R	0800366	30			
WMS 4,8 (60 x 9)R YE	0800400	30			
WMS 4,8 (60 x 9)RL	0800385	30			
WMS 4,8 (60 x 9)RXL	0800393	30			
WMS 4,8 (E x 9)R	0800291	31			
WMS 4,8 (E x 9)R BK	0800418	31			
WMS 4,8 (E x 9)R YE	0800302	31			
WMS 4,8 (E x 9)RL	0800321	31			
WMS 4,8 (E x 9)RL BK	0800429	31			
WMS 4,8 (E x 9)RL YE	0800330	31			
WMS 50,8 (E x 80)R	0800299	31			
WMS 50,8 (E x 80)R BK	0800426	31			
WMS 50,8 (E x 80)R YE	0800311	31			
WMS 6,4 (E x 10)R	0800292	31			
WMS 6,4 (E x 10)R BK	0800419	31			
WMS 6,4 (E x 10)R YE	0800303	31			
WMS 6,4 (E x 10)RL	0800322	31			
WMS 6,4 (E x 10)RL BK	0800430	31			
WMS 6,4 (E x 10)RL YE	0800331	31			
WMS 9,5 (E x 16)R	0800293	31			
WMS 9,5 (E x 16)R BK	0800421	31			
WMS 9,5 (E x 16)R YE	0800304	31			
WMS 9,5 (E x 16)RL	0800324	31			
WMS 9,5 (E x 16)RL BK	0800431	31			
WMS 9,5 (E x 16)RL YE	0800332	31			
WMT 2,4 (15 x 4)R	0816281	29			
WMT 3,5 (15 x 5)R	0817222	29			
WMT 4,2 (15 x 6)R	0817235	29			
WMT 5,5 (15 x 8)R	0817248	29			
WMT 8,4 (17 x 10)R	0817251	29			
WMTB (24 x 8)R	0816278	29			
WMTB (35 x 15)R	0817316	29			





Further information on the products presented here and on the world of solutions from Phoenix Contact can be found at [www.phoenixcontact.net/catalog](http://www.phoenixcontact.net/catalog)



Or contact us directly.



PHOENIX CONTACT GmbH & Co. KG  
32823 Blomberg, Germany  
Phone: +49 5235 3-00  
Fax: +49 5235 3-4 12 00  
[www.phoenixcontact.com](http://www.phoenixcontact.com)

Компания «Океан Электроники» предлагает заключение долгосрочных отношений при поставках импортных электронных компонентов на взаимовыгодных условиях!

Наши преимущества:

- Поставка оригинальных импортных электронных компонентов напрямую с производств Америки, Европы и Азии, а так же с крупнейших складов мира;
- Широкая линейка поставок активных и пассивных импортных электронных компонентов (более 30 млн. наименований);
- Поставка сложных, дефицитных, либо снятых с производства позиций;
- Оперативные сроки поставки под заказ (от 5 рабочих дней);
- Экспресс доставка в любую точку России;
- Помощь Конструкторского Отдела и консультации квалифицированных инженеров;
- Техническая поддержка проекта, помощь в подборе аналогов, поставка прототипов;
- Поставка электронных компонентов под контролем ВП;
- Система менеджмента качества сертифицирована по Международному стандарту ISO 9001;
- При необходимости вся продукция военного и аэрокосмического назначения проходит испытания и сертификацию в лаборатории (по согласованию с заказчиком);
- Поставка специализированных компонентов военного и аэрокосмического уровня качества (Xilinx, Altera, Analog Devices, Intersil, Interpoint, Microsemi, Actel, Aeroflex, Peregrine, VPT, Syfer, Eurofarad, Texas Instruments, MS Kennedy, Miteq, Cobham, E2V, MA-COM, Hittite, Mini-Circuits, General Dynamics и др.);

Компания «Океан Электроники» является официальным дистрибьютором и эксклюзивным представителем в России одного из крупнейших производителей разъемов военного и аэрокосмического назначения «JONHON», а так же официальным дистрибьютором и эксклюзивным представителем в России производителя высокотехнологичных и надежных решений для передачи СВЧ сигналов «FORSTAR».



## JONHON

«JONHON» (основан в 1970 г.)

Разъемы специального, военного и аэрокосмического назначения:

(Применяются в военной, авиационной, аэрокосмической, морской, железнодорожной, горно- и нефтедобывающей отраслях промышленности)

«FORSTAR» (основан в 1998 г.)

ВЧ соединители, коаксиальные кабели, кабельные сборки и микроволновые компоненты:

(Применяются в телекоммуникациях гражданского и специального назначения, в средствах связи, РЛС, а так же военной, авиационной и аэрокосмической отраслях промышленности).



Телефон: 8 (812) 309-75-97 (многоканальный)

Факс: 8 (812) 320-03-32

Электронная почта: [ocean@oceanchips.ru](mailto:ocean@oceanchips.ru)

Web: <http://oceanchips.ru/>

Адрес: 198099, г. Санкт-Петербург, ул. Калинина, д. 2, корп. 4, лит. А