

**GENERAL DESCRIPTION**

This document describes the specifications for the IDTF1152 Zero-Distortion™ RF to IF Downconverting Mixer. This device is part of a series of mixers offered with high side or low side injection options for all UTRA bands. See the Part# Matrix for the details of all devices in this series.

The F1152 dual channel device is designed to operate with a single 5V supply. It is optimized for operation in a Multi-mode, Multi-carrier BaseStation Receiver for RF bands from 1700 - 2200 MHz with Low Side Injection or from 1400 to 1700 MHz with High Side Injection. IF frequencies from 50 to 350 MHz are supported. Nominally, the device offers +43 dBm Output IP3 with 327 mA of I<sub>CC</sub>. Alternately one can adjust 4 resistor values and a toggle pin to run the device in low current mode with +40 dBm Output IP3 and 232 mA of I<sub>CC</sub>.

**COMPETITIVE ADVANTAGE**

In typical basestation receivers the RF to IF mixer dominates the linearity performance for the entire receive system. The Zero-Distortion™ family of mixers dramatically improve the maximum signal levels (IM<sub>3</sub> tones) that the BTS can withstand at a desired Signal to Noise Ratio (SNR.) Alternately, one can run the device in Low Current Mode to reduce Power consumption significantly. Zero-Distortion™ technology allows realization of either benefit.

- ✓ IP<sub>30</sub>: ↑ **9 dB** STD Mode, ↑ **6 dB** LC Mode
- ✓ Dissipation: ↓ **40%** LC Mode, ↓ **12%** STD Mode
- ✓ Allows for higher RF gain improving **Sensitivity**



**PART# MATRIX**

Part#	RF freq range	UTRA bands	IF freq range	Typ. Gain	Injection
F1100	698 - 915	5,6,8,12,13,14,17,19,20	50 - 450	8.5	High Side
F1102	698 - 915	5,6,8,12,13,14,17,19,20	50 - 250	8.5	Both
F1150	1700 - 2200	1,2,3,4,9,10,33,34,35,36,37,39	50 - 450	8.5	High Side
<b>F1152</b>	<b>1400 - 2200</b>	<b>1,2,3,4,9,10,11<sup>1</sup>,21<sup>1</sup>,24<sup>1</sup>,33,34,35,36,37,39</b>	<b>50 - 350</b>	<b>8.5</b>	<b>Low Side</b>
F1162	2300 - 2700	7,38,40,41	50 - 500	8.9	Both

1 - with High side injection

**FEATURES**

- Dual Path for Diversity Systems
- Ideal for Multi-Carrier Systems
- 8.5 dB Gain
- Ultra linear **+43 dBm IP<sub>30</sub>**
- Low NF < 10 dB
- 200 Ω output impedance
- Ultra high +13 dBm P1dB<sub>1</sub>
- **Pin Compatible** w/existing solutions
- 6x6 36 pin package
- **Power Down mode**
- < 200 nsec settling from Power Down
- Minimizes Synth pulling in Standby Mode
- Low Current Mode : **I<sub>CC</sub> = 232 mA**
- Standard Mode: I<sub>CC</sub> = 327 mA
- NOTE production BOM on p. 20

**DEVICE BLOCK DIAGRAM**

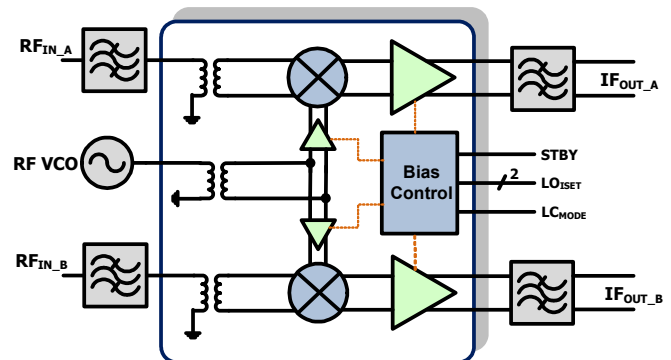

**ORDERING INFORMATION**

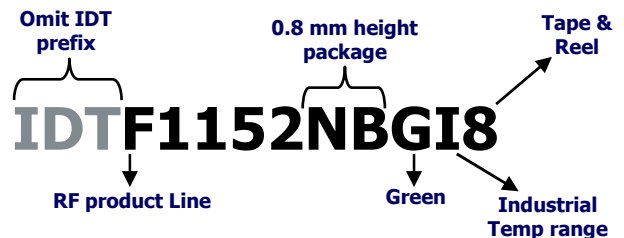

**ABSOLUTE MAXIMUM RATINGS**

VCC to GND	-0.3V to +5.5V
STBY, LC <sub>MODE</sub>	-0.3V to (VCC <sub>-</sub> + 0.3V)
IF_A+, IF_B+, IF_A-, IF_B-, LO1_ADJ, LO2_ADJ	-0.3V to (VCC <sub>-</sub> + 0.3V)
LO_IN, LO_IN_ALT, RF_A, RF_B	-0.3V to +0.3V
IF_BiasA, IF_BiasB to GND	-0.3V to +0.3V
RF Input Power (RF_IN[A+, A-, B+, B-])	+20dBm
Continuous Power Dissipation	2.2W
$\theta_{JA}$ (Junction – Ambient)	+35°C/W
$\theta_{JC}$ (Junction – Case) The Case is defined as the exposed paddle	+2.5°C/W
Operating Temperature Range (Case Temperature)	T <sub>C</sub> = -40°C to +100°C
Maximum Junction Temperature	150°C
Storage Temperature Range	-65°C to +150°C
Lead Temperature (soldering, 10s) .	+260°C

*Stresses above those listed above may cause permanent damage to the device. Functional operation of the device at these or any other conditions above those indicated in the operational section of this specification is not implied. Exposure to absolute maximum rating conditions for extended periods may affect device reliability.*

**RF to IF Dual Downconverting Mixer**
**1400 - 2200 MHz F1152NBGI**
**IDTF1152 SPECIFICATION**

Specifications apply at  $V_{CC} = +5.00V$ ,  $T_C = +25^\circ C$   $F_{RF} = 1850 \text{ MHz}$ ,  $F_{IF} = 200\text{MHz}$ ,  $P_{LO} = 0 \text{ dBm}$ ,  $STBY = GND$ ,  $LC_{MODE} = V_{IH}$  (STD Mode), EVKit BOM = Standard Mode, Transformer Loss included (not de-embedded) unless otherwise noted.

Parameter	Comment	Symbol	min	typ	max	units
Logic Input High	For Standby, $LC_{MODE}$ Pins	$V_{IH}$	<b>2</b>			V
Logic Input Low	For Standby, $LC_{MODE}$ Pins	$V_{IL}$			<b>0.8</b>	V
Logic Current	For Standby, $LC_{MODE}$ Pins	$I_{IH}, I_{IL}$	<b>-100</b>		<b>-20</b>	$\mu A$
Supply Voltage(s)	All $V_{CC}$ pins	$V_{CC}$		4.75 to 5.25		V
Operating Temperature Range	Case Temperature	$T_{CASE}$		-40 to +100		degC
Supply Current	Total $V_{CC}$ , STD Mode ▪ Total Both Channels	$I_{STD}$		<b>327</b>	<b>380<sup>1</sup></b>	mA
Supply Current	Total $V_{CC}$ , LC Mode ▪ $LC_{MODE} = GND$ ▪ EVkit BOM = LC Mode ▪ Total Both Channels	$I_{LC}$		<b>232</b>	<b>260</b>	mA
Supply Current	Standby Mode ▪ $STBY = V_{IH}$ ▪ Total Both Channels	$I_{STBY}$		<b>17</b>	<b>26</b>	mA
RF Freq Range	Operating Range (low side injection)	$F_{RF}$		1700 to 2200		MHz
RF Freq Range	Operating Range (hi-side inj. with RF match p. 20)			1400 - 1700		MHz
IF Freq Range	Operating Range	$F_{IF}$		50 to 350		MHz
LO Freq Range	Low Side Injection	$F_{LO}$		1350 to 2100		MHz
LO Power		$P_{LO}$		-3 to +6		dBm
RF Input Impedance	Single Ended <i>Return Loss ~17 dB</i>	$Z_{RF}$		50		$\Omega$
IF Output Impedance	Differential <i>Return Loss ~ 13 dB</i>	$Z_{IF}$		200		$\Omega$
LO port Impedance	Single Ended <i>Return Loss ~15 dB</i>	$Z_{LO}$		50		$\Omega$
Settling Time	• Pin = -13 dBm • Gate STBY from $V_{IH}$ to $V_{IL}$ • Time for IF Signal to settle to within 0.1 dB of final value	$T_{SETT}$		0.155		$\mu sec$
Gain STD Mode	Conversion Gain • $F_{RF} = 1710 \text{ MHz}$ • $LC_{MODE} = V_{IH}$ • EVkit BOM = STD Mode • $F_{IF} = 200 \text{ MHz}$	$G_{STD}$	<b>7.6</b>	<b>8.5</b>	<b>9.5</b>	dB

**IDTF1152 SPECIFICATION (CONTINUED)**

Parameter	Comment	Symbol	min	typ	max	units
Gain LC Mode	Conversion Gain • $F_{RF} = 2050$ MHz • $LC_{MODE} = GND$ • EVkit BOM = LC Mode • $F_{IF} = 200$ MHz	$G_{LC}$	<b>7.1</b>	<b>8.0</b>	<b>9.1</b>	dB
NF STD Mode	Noise Figure	$NF_{STD}$		10		dB
NF LC Mode	Noise Figure • $LC_{MODE} = GND$ • EVkit BOM = LC Mode • $F_{IF} = 200$ MHz	$NF_{LC}$		9.6		dB
NF w/Blocker	▪ +100 MHz offset blocker ▪ $P_{IN} = +4$ dBm ▪ $F_{IF} = 250$ MHz	$NF_{BLK}$		16.5		dB
Output IP3 – Narrowband	▪ $P_{IN} = -5$ dBm per tone ▪ 800 KHz Tone Separation	$IP3_{O1}$	39 <sup>2</sup>	43		dBm
Output IP3 – Wideband	▪ $P_{IN} = -5$ dBm per tone ▪ 30 MHz Tone Separation	$IP3_{O2}$		42		dBm
Output IP3 – $LC_{MODE}$	▪ $P_{IN} = -10$ dBm per tone ▪ $F_{IF} = 200$ MHz ▪ 800 KHz Tone Separation ▪ $LC_{MODE} = GND$ ▪ EVKit BOM = LC Mode	$IP3_{O3}$	<b>36</b>	<b>41</b>		dBm
2RF – 2LO rejection	▪ $P_{RF} = -10$ dBm ▪ Frequency = $F_{RF} - \frac{1}{2} F_{IF}$	2x2		-72		dBc
1 dB Compression	▪ Input referred	$P1dB_{I1}$	11.5	13.2		dBm
1 dB Compression - $LC_{MODE}$	▪ Input referred ▪ $LC_{MODE} = GND$ ▪ EVKit BOM = LC Mode ▪ $F_{IF} = 200$ MHz	$P1dB_{I2}$	<b>8</b>	<b>10.8</b>		dBm
Gain Comp. w/blocker	▪ Blocker → unmodulated tone ▪ $P_{IN} = +8$ dBm, -100 MHz offset ▪ Signal Pin Tone = -20 dBm ▪ Measure $\Delta G$ of signal ▪ $F_{IF} = 250$ MHz	$\Delta G_{AC}$		0.15		dB
Channel Isolation	IF_B Pout vs. IF_A w/ RF_A input	$ISO_C$	45	49		dB
LO to IF leakage		$ISO_{LI}$		-22	-15	dBm
RF to IF leakage	$P_{in} = -10$ dBm	$ISO_{RI}$		-32	-25	dBm
LO to RF leakage		$ISO_{LR}$		-40		dBm

1 – Items in min/max columns in **bold italics** are Guaranteed by Test

2 – All other Items in min/max columns are Guaranteed by Design Characterization

**TYPICAL OPERATING CONDITIONS**

Unless otherwise Noted, the following Apply to the Typ Ops Graphs

- Low Side Injection, 200 MHz IF, 800 KHz Tone Spacing
- RF frequency = 1850 MHz for single point measurements
- Average of Channel A & Channel B
- Pin = - 10 dBm (all graphs, note exception immediately below)
- Pin = -5 dBm (STD Mode IP3 Traces)
- LO port = Pin 19 (Main Port)
- Listed Temperatures are Case Temperature ( $T_C$  = Case Temperature)
- Where noted,  $T_A$  or  $T_{AMB}$  = Ambient Temperature

TYPICAL OPERATING CONDITIONS (-1-)

Gain vs.  $T_{CASE}$

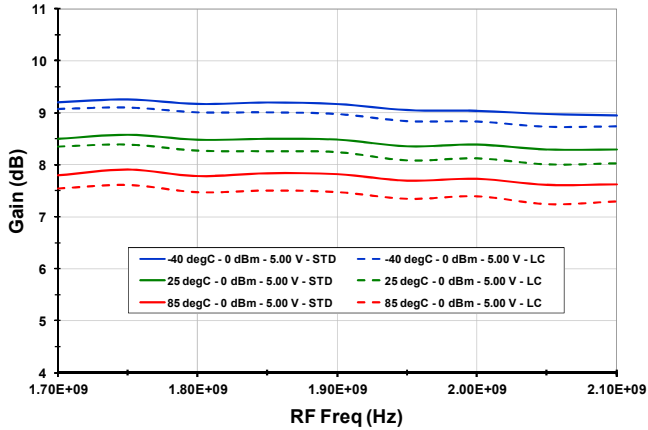

Gain vs.  $V_{CC}$

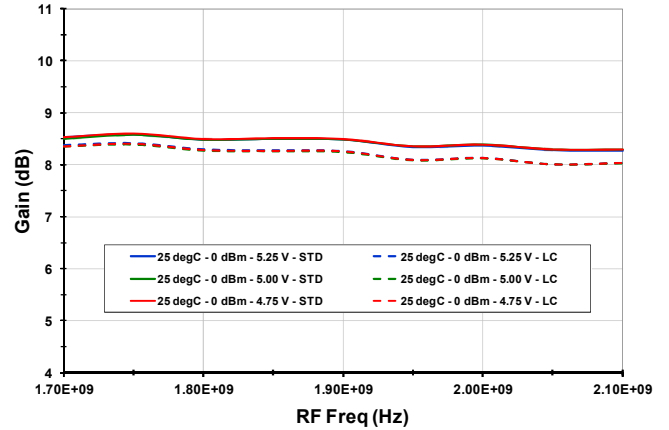

Gain vs. LO Level

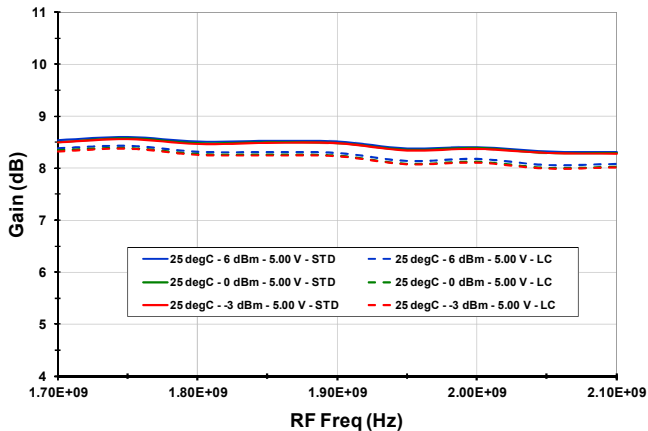

Output IP3 vs.  $T_{CASE}$

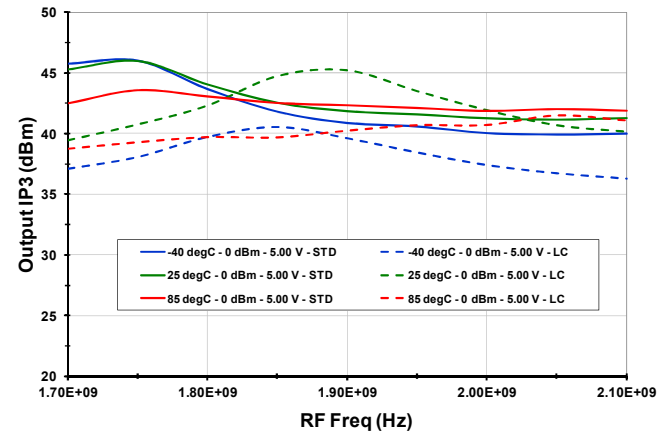

Output IP3 vs.  $V_{CC}$

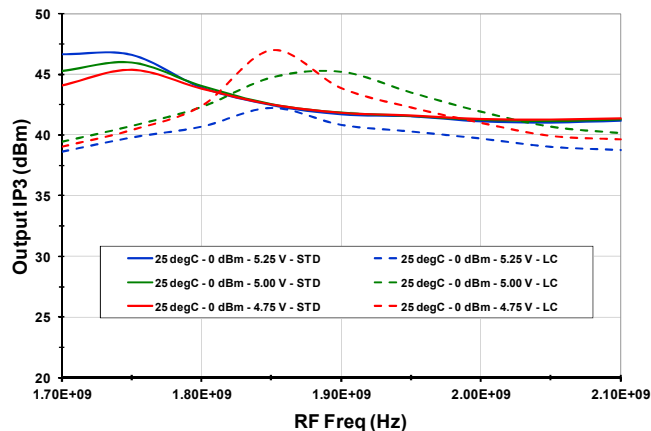

Output IP3 vs. LO Level

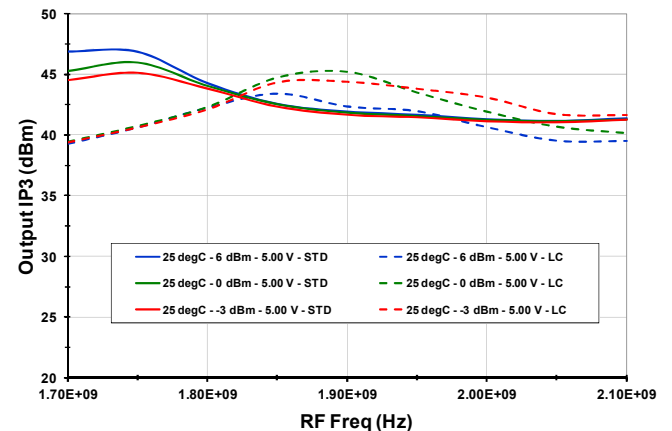

RF to IF Dual Downconverting Mixer

1400 - 2200 MHz F1152NBGI

TYPICAL OPERATING CONDITIONS (-2-)

P1dB vs. T<sub>CASE</sub>

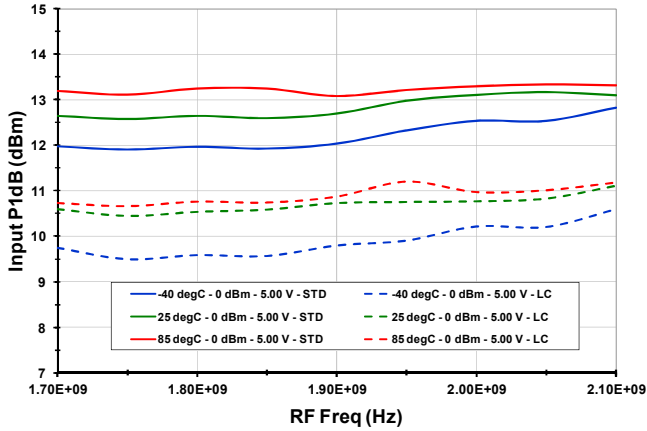

P1dB vs. V<sub>CC</sub>

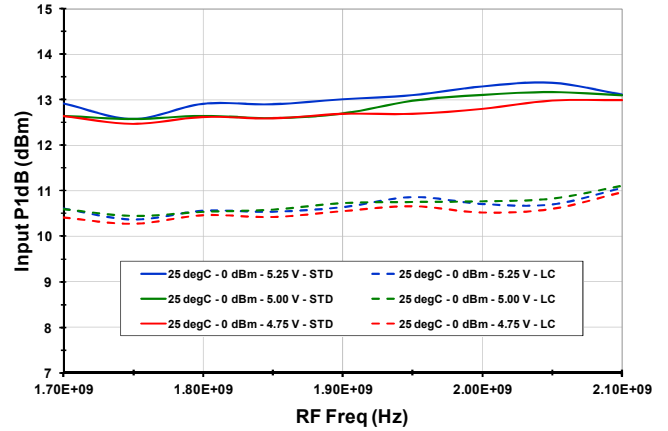

P1dB vs. LO Level

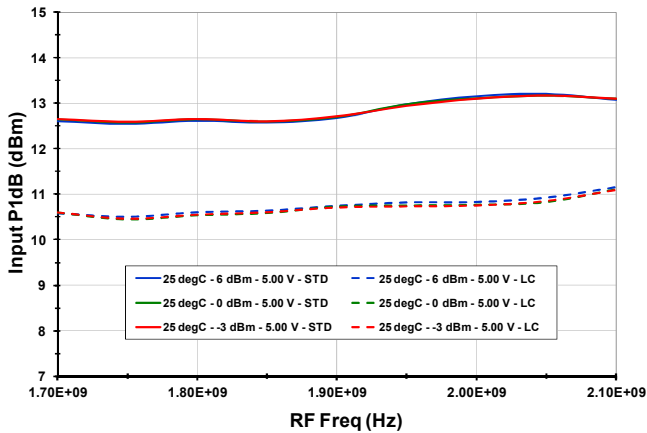

2RF x 2LO rejection vs. T<sub>CASE</sub>

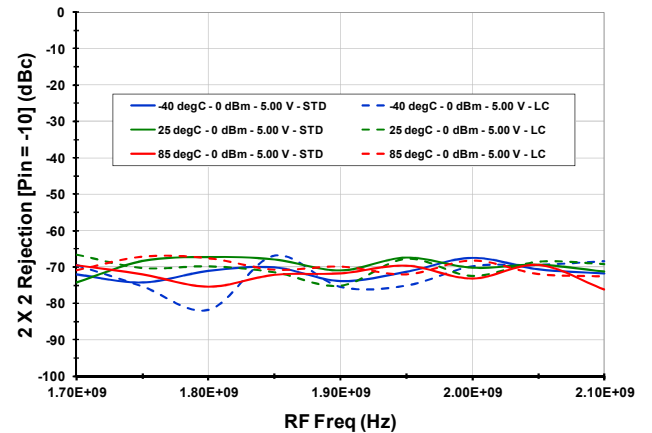

2RF x 2LO Rejection vs. V<sub>CC</sub>

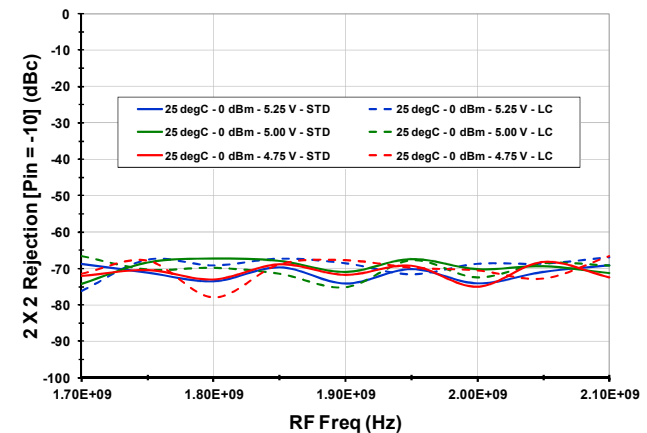

2RF x 2LO rejection vs. LO Level

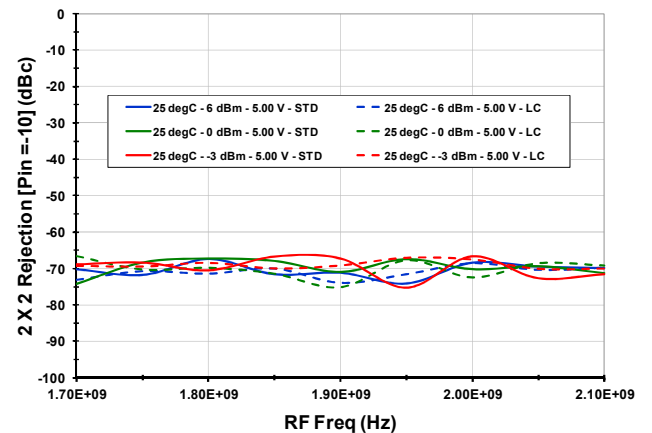

RF to IF Dual Downconverting Mixer

1400 - 2200 MHz F1152NBGI

TYPICAL OPERATING CONDITIONS (-3-)

**I<sub>CC</sub> vs. T<sub>CASE</sub>**

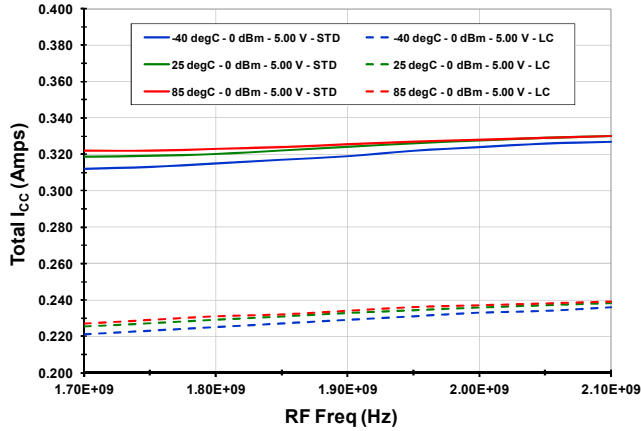

**I<sub>CC</sub> vs. V<sub>CC</sub>**

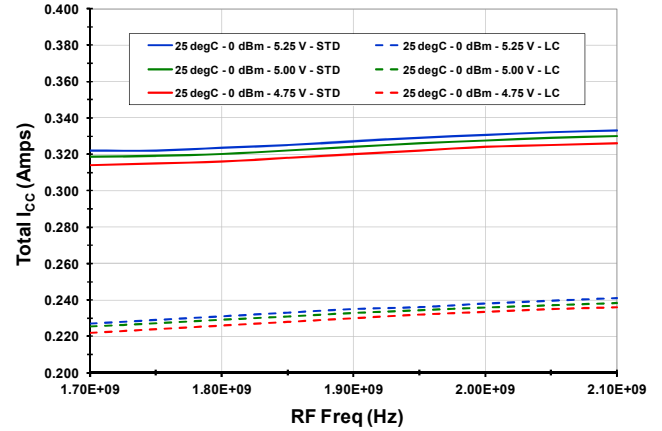

**I<sub>CC</sub> vs. LO Level**

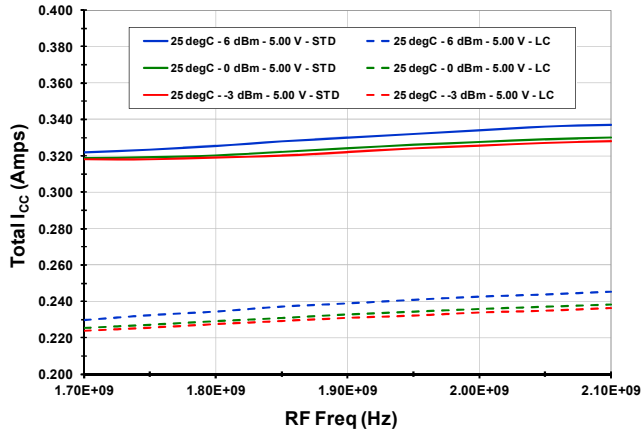

**LO-IF Leakage vs. T<sub>CASE</sub>**

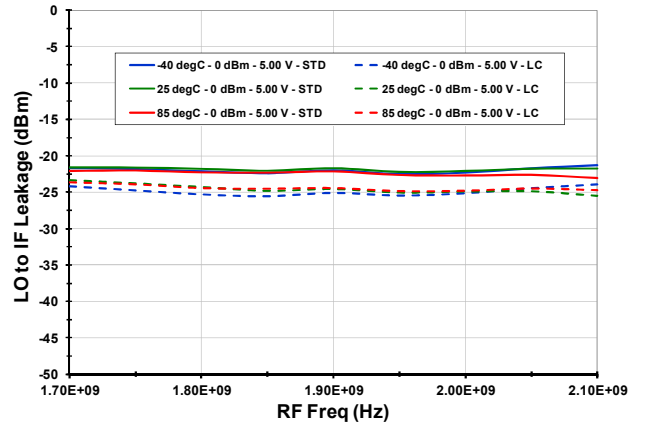

**LO-IF Leakage vs. V<sub>CC</sub>**

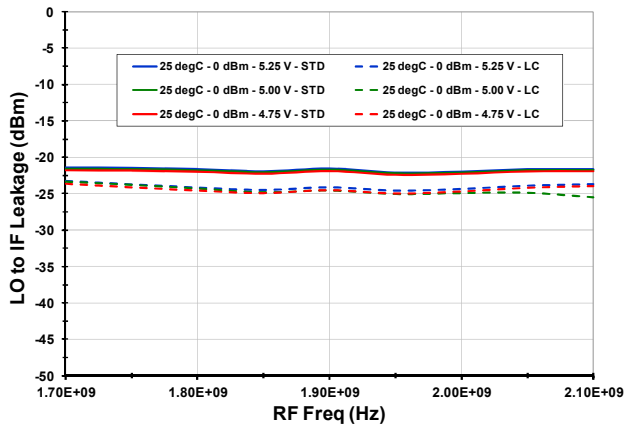

**LO-IF Leakage vs. LO Level**

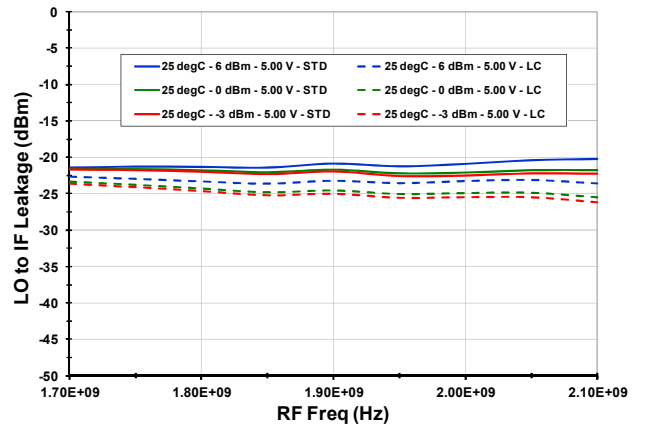



RF to IF Dual Downconverting Mixer

1400 - 2200 MHz F1152NBGI

TYPICAL OPERATING CONDITIONS (-4-)

RF-IF Leakage vs.  $T_{CASE}$

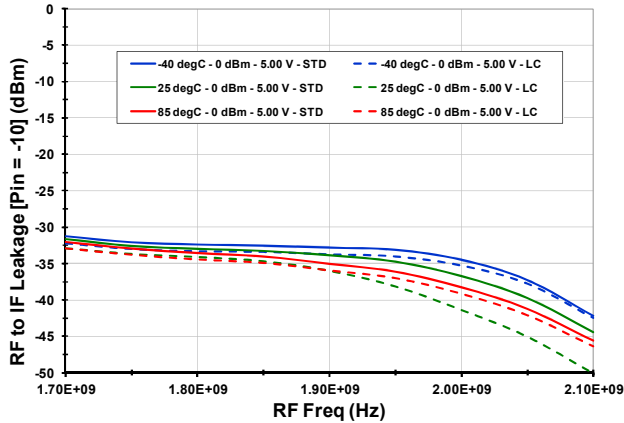

RF-IF Leakage vs.  $V_{CC}$

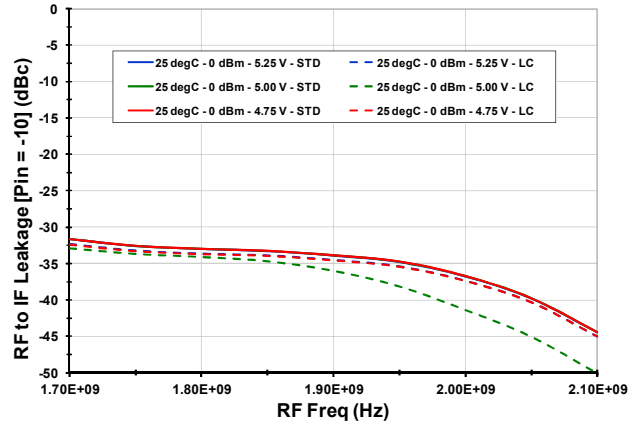

RF-IF Leakage vs. LO Level

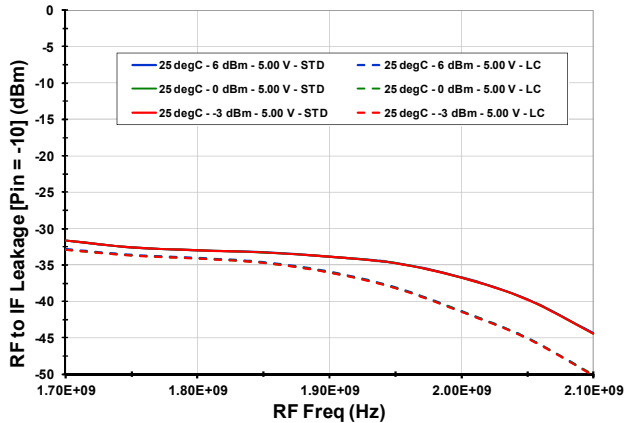

3RF X 3LO Rejection vs. LO Level

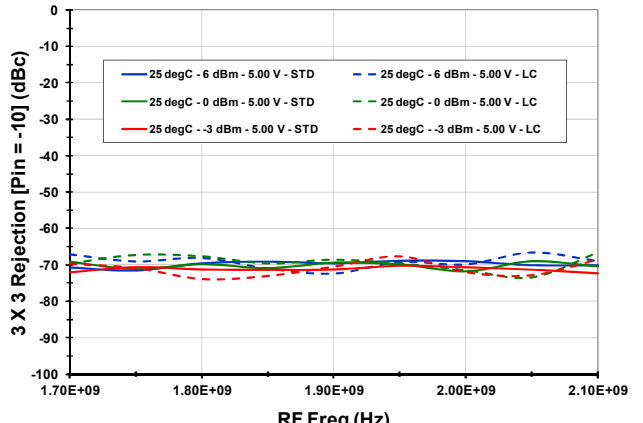

IP<sub>3O</sub> Distribution ( $F_{RF} = 1850\text{MHz}$ , LC mode,  $N = 3168$ )

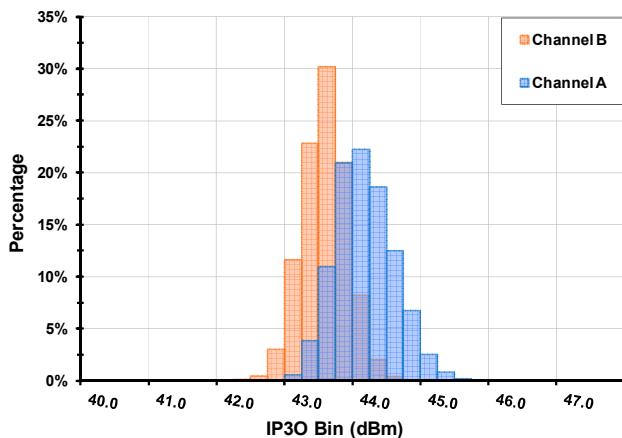

Gain Distribution ( $F_{RF} = 1710\text{MHz}$ , STD mode,  $N = 3168$ )

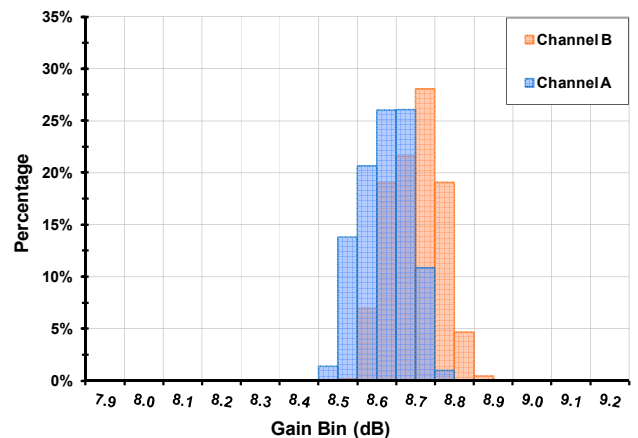

RF to IF Dual Downconverting Mixer

1400 - 2200 MHz F1152NBGI

TYPICAL OPERATING CONDITIONS (-5-)

Channel Isolation vs.  $T_{CASE}$

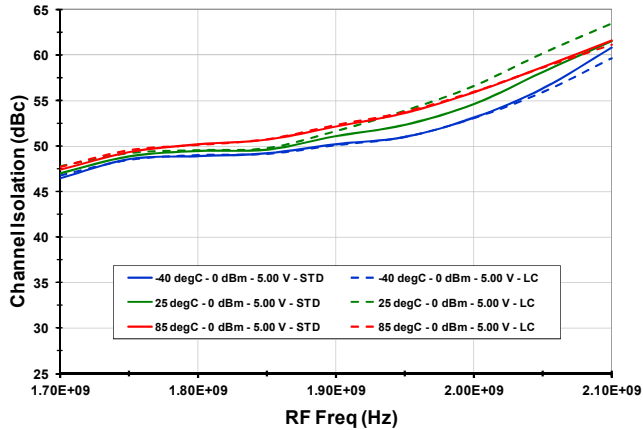

Channel Isolation vs.  $V_{CC}$

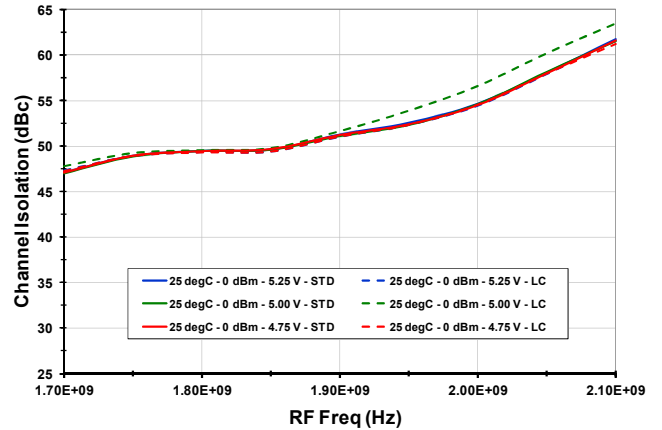

Channel Isolation vs. LO Level

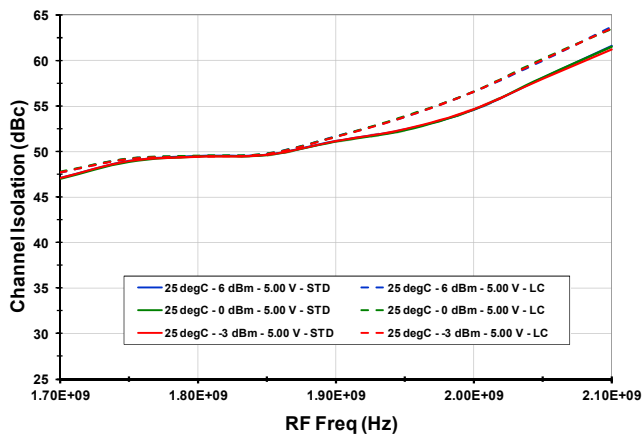

Noise Figure vs.  $T_{CASE}$  (LC Mode)

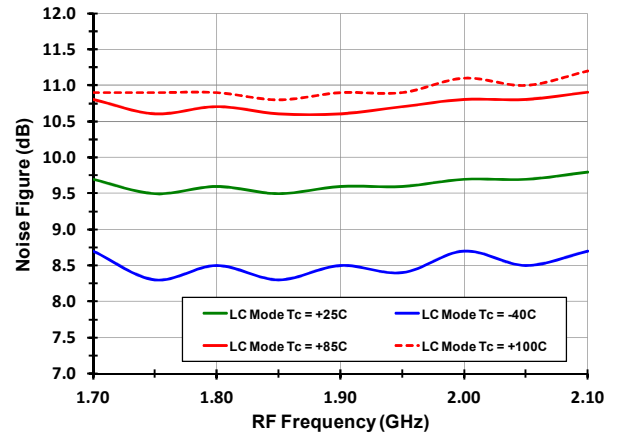

Noise Figure vs.  $T_{CASE}$  (STD Mode)

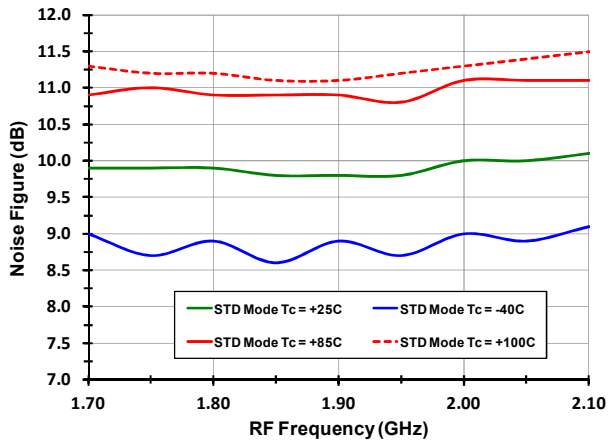

NF vs. Blocker (RF = 1850 MHz, IF = 250 MHz,  $T_A = 25C$ )

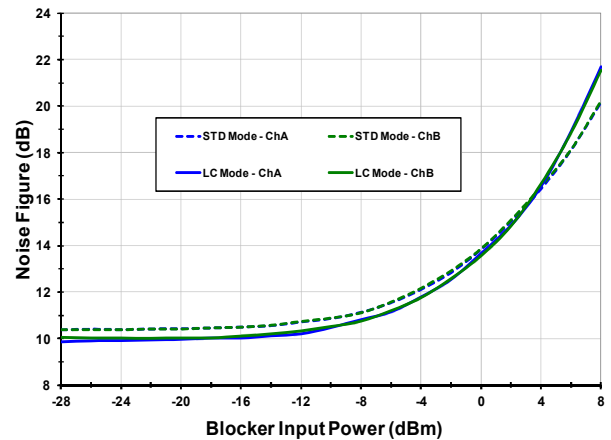

RF to IF Dual Downconverting Mixer

1400 - 2200 MHz F1152NBGI

TYPICAL OPERATING CONDITIONS (-6-)

EVkit IF Port Match ( $T_A = 25C$ )

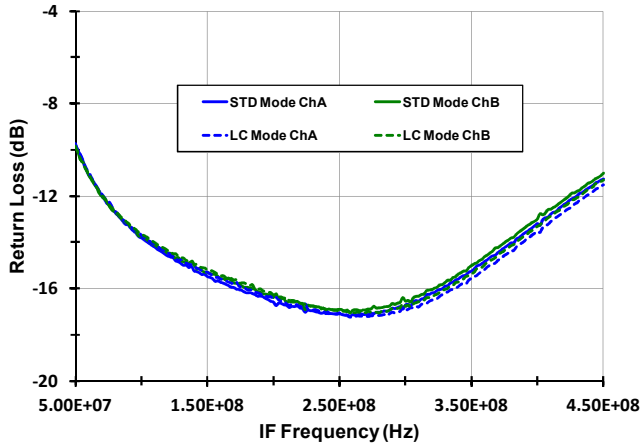

Alt. LO port (pin27) vs. Main LO port (pin19)

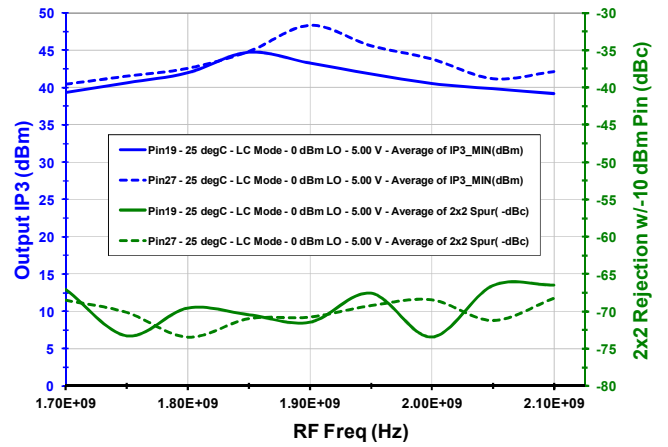

Settling Time (STBY ->  $V_{IL}$ )

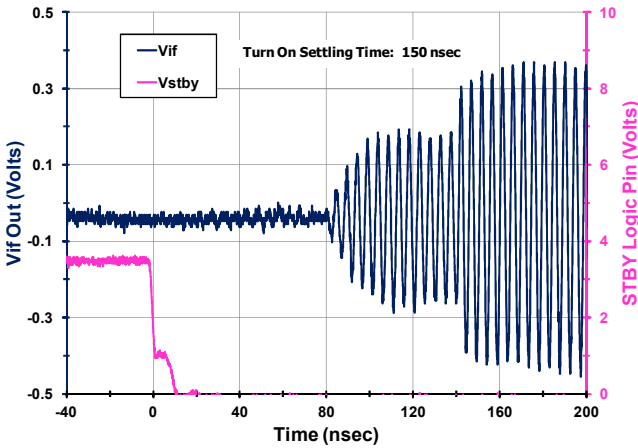

Settling Time (STBY ->  $V_{IH}$ )

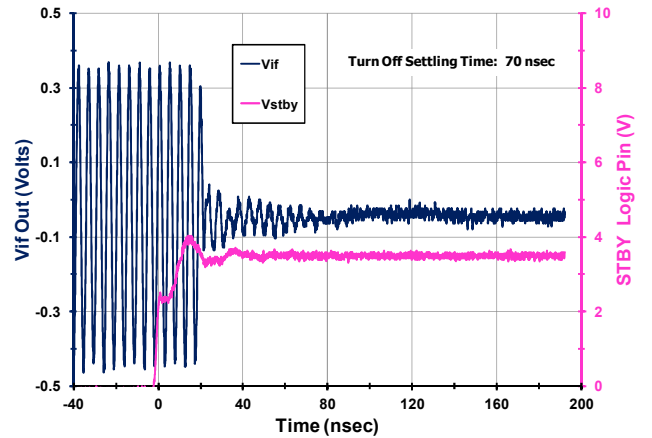

EVKit LO Port Match ( $T_A = 25C, P_{MEAS} = 0 \text{ dBm}$ )

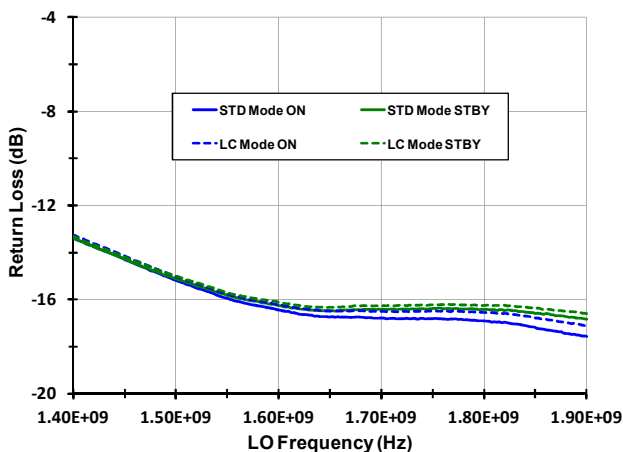

EVkit RF Port Match ( $T_A = 25C$ )

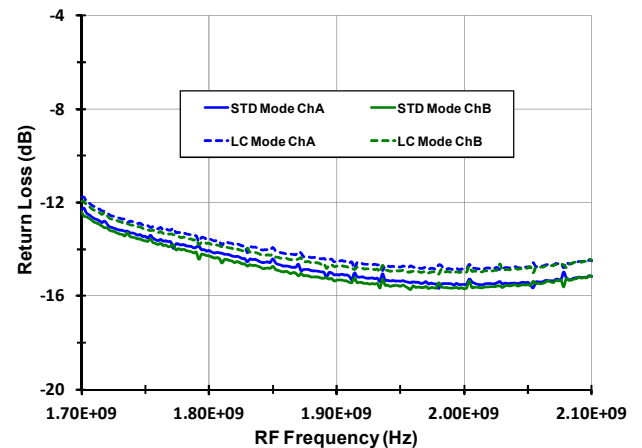

RF to IF Dual Downconverting Mixer

1400 - 2200 MHz F1152NBGI

TYPICAL OPERATING CONDITIONS (-7-)

IP<sub>3O</sub> vs. Tone  $\Delta f$  (T<sub>A</sub> = 25C, Freq = 1850 MHz)

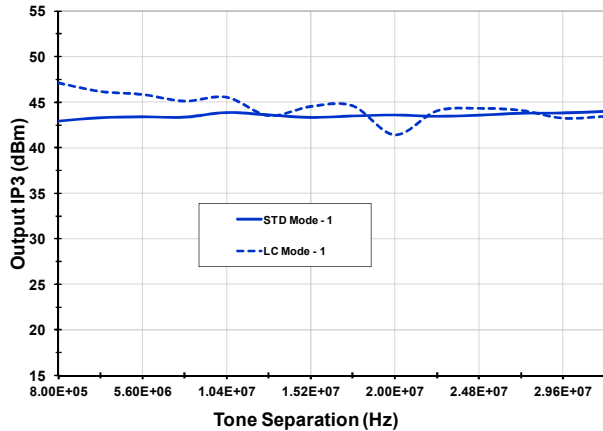

IP<sub>3O</sub> vs. P<sub>IN</sub> (T<sub>A</sub> = 25C, Freq = 1850 MHz)

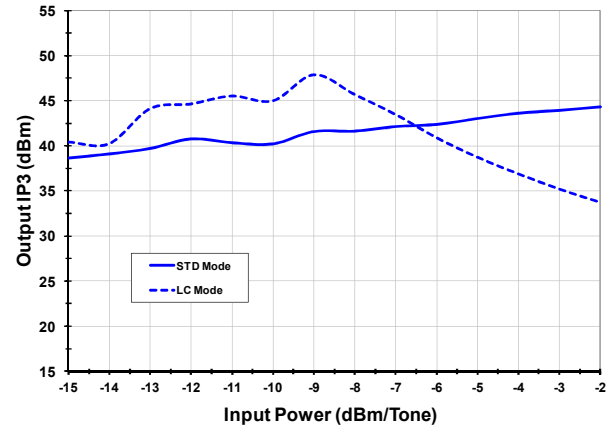

Hi-side Injection Gain (Bands 11, 21, 24 see p. 20)

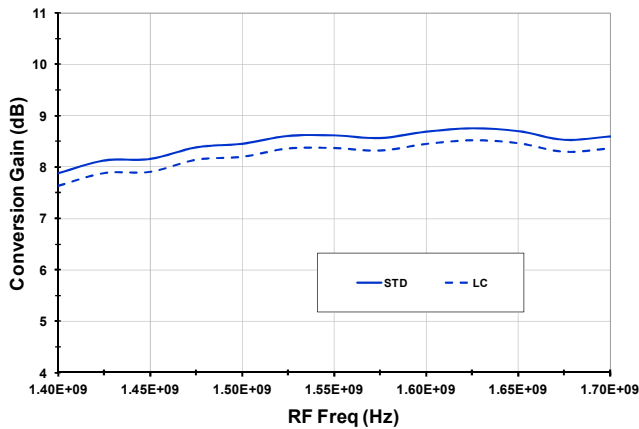

Hi-side Injection Output IP3 (Bands 11, 21, 24)

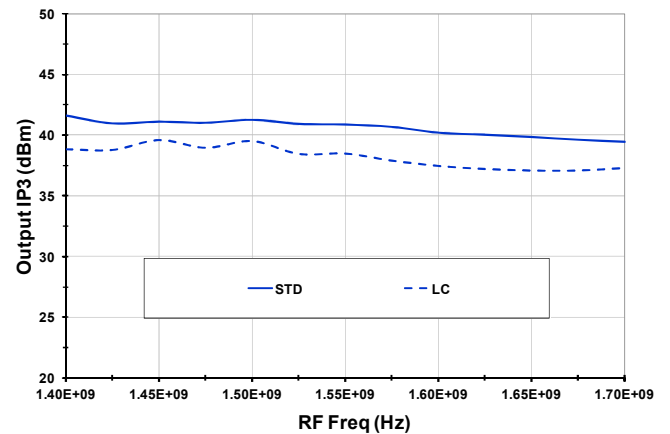

Hi-side Injection P1dB<sub>I</sub> (Bands 11, 21, 24)

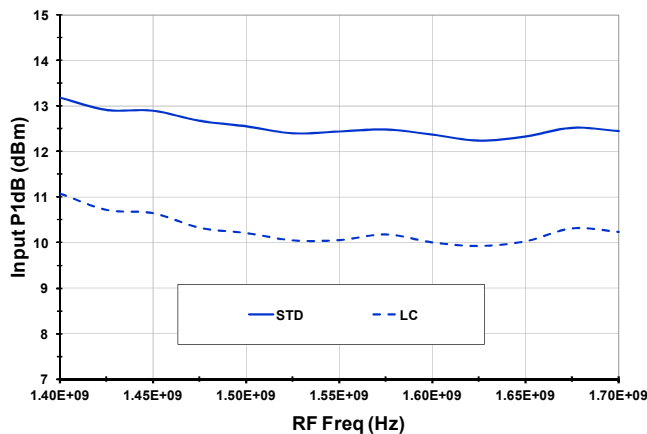

Hi-side Injection 2x2 (Bands 11, 21, 24)

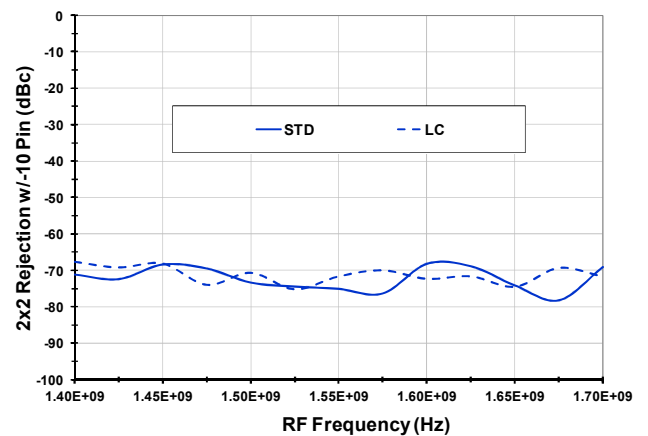

RF to IF Dual Downconverting Mixer

1400 - 2200 MHz F1152NBGI

TYPICAL OPERATING CONDITIONS (-8-)

Hi-side Injection LO to IF (Bands 11, 21, 24)

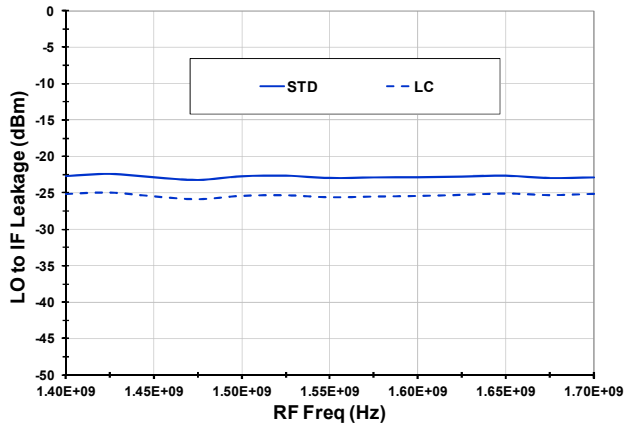

Hi-side Injection RF to IF (Bands 11, 21, 24)

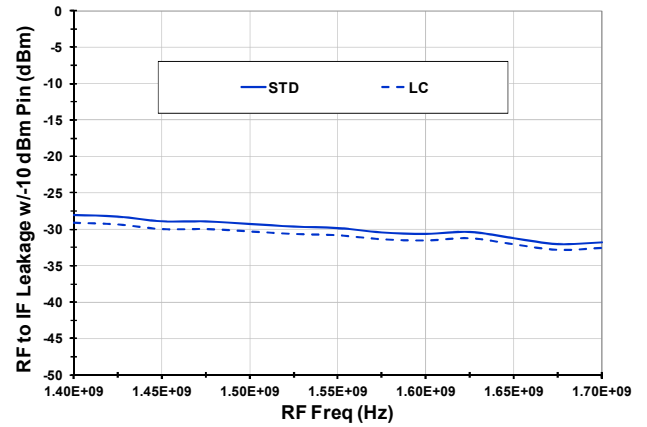

Hi-side Injection 3x3 (Bands 11, 21, 24)

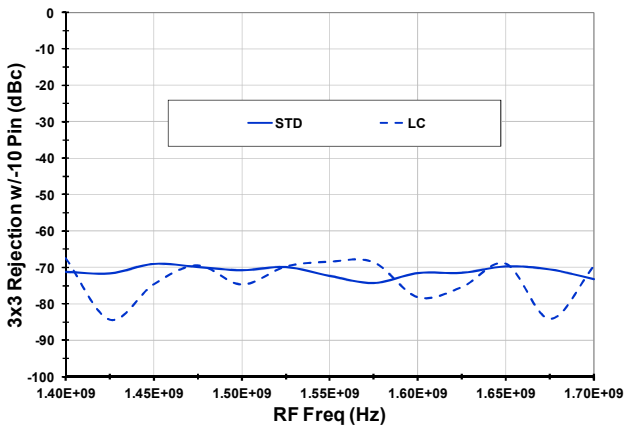

Hi-side Injection Channel Iso (Bands 11, 21, 24)

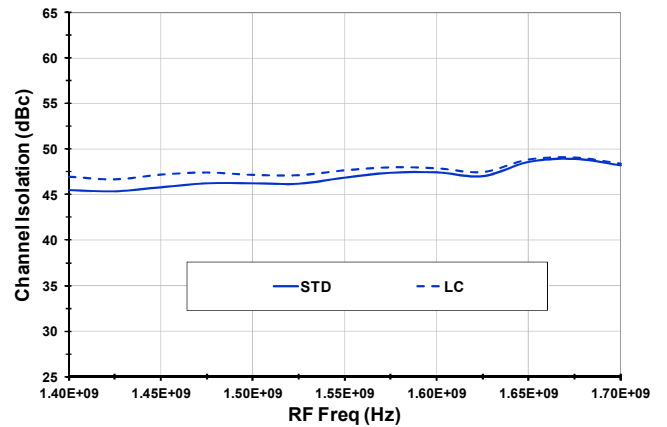

Hi-side Injection I<sub>CC</sub> (Bands 11, 21, 24)

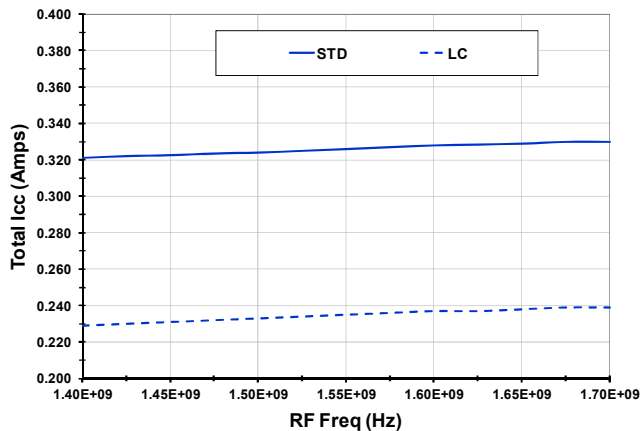

Hi-side Injection RF Port Matches (see p. 22)

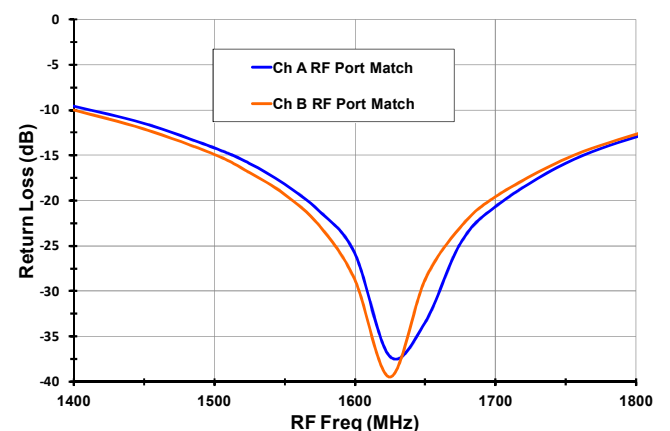

**HIGH TEMPERATURE OPERATING CONDITIONS (-1-)**

**Gain at Normal and High (+100C) Temps**

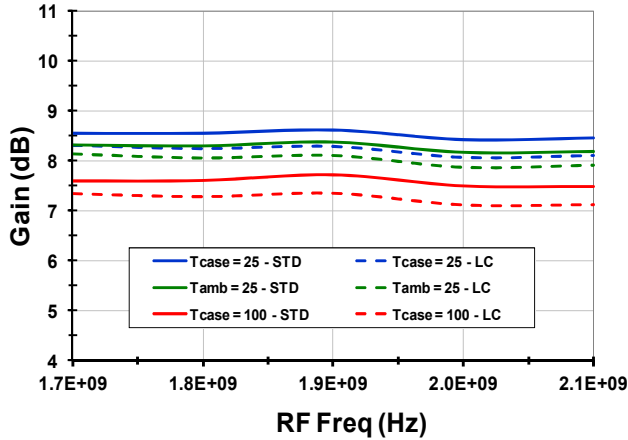

**Output IP3 at Normal and High (+100C) Temps**

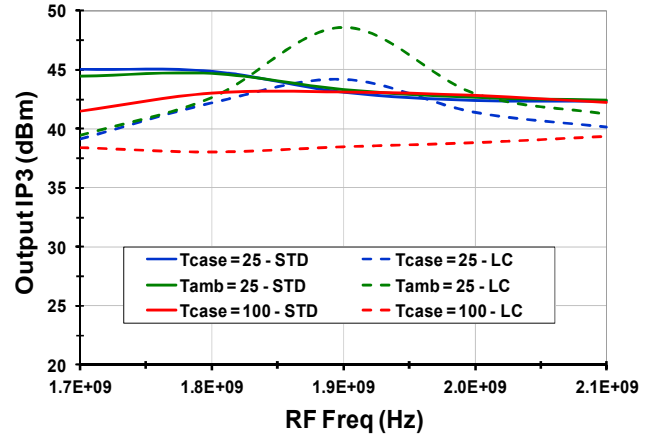

**Input P1dB at Normal and High (+100C) Temps**

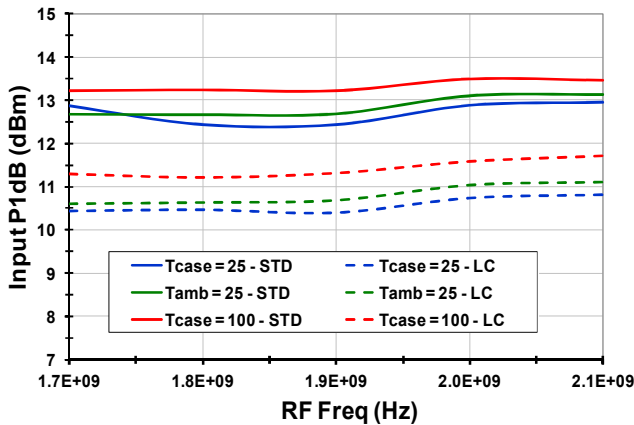

**2RF X 2LO at Normal and High (+100C) Temps**

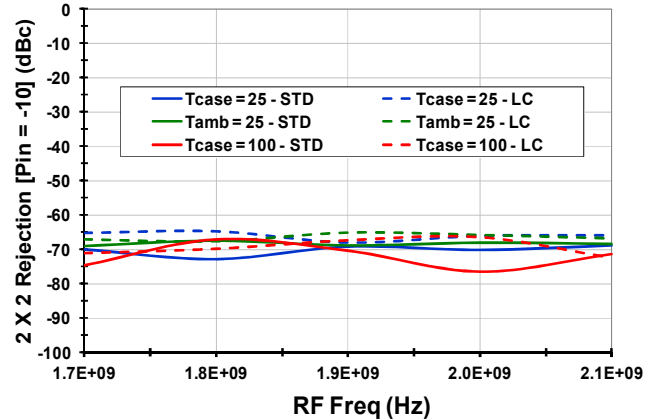

**3RF X 3LO at Normal and High (+100C) Temps**

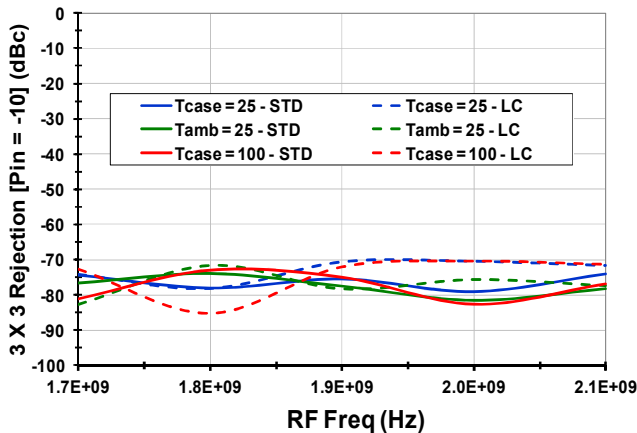

**Output P1dB at Normal and High (+100C) Temps**

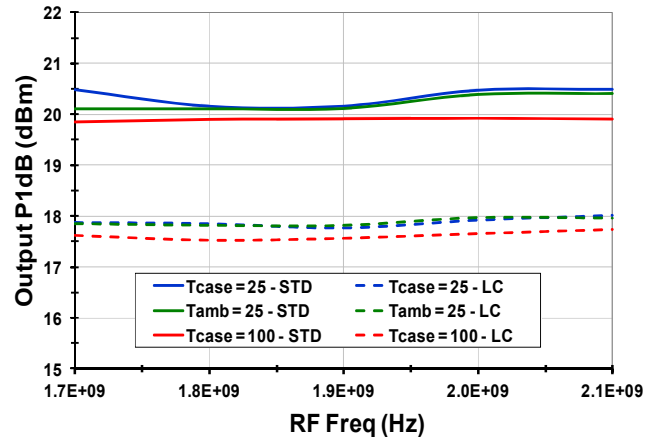



RF to IF Dual Downconverting Mixer

1400 - 2200 MHz F1152NBGI

PACKAGE DRAWING (6X6 QFN)

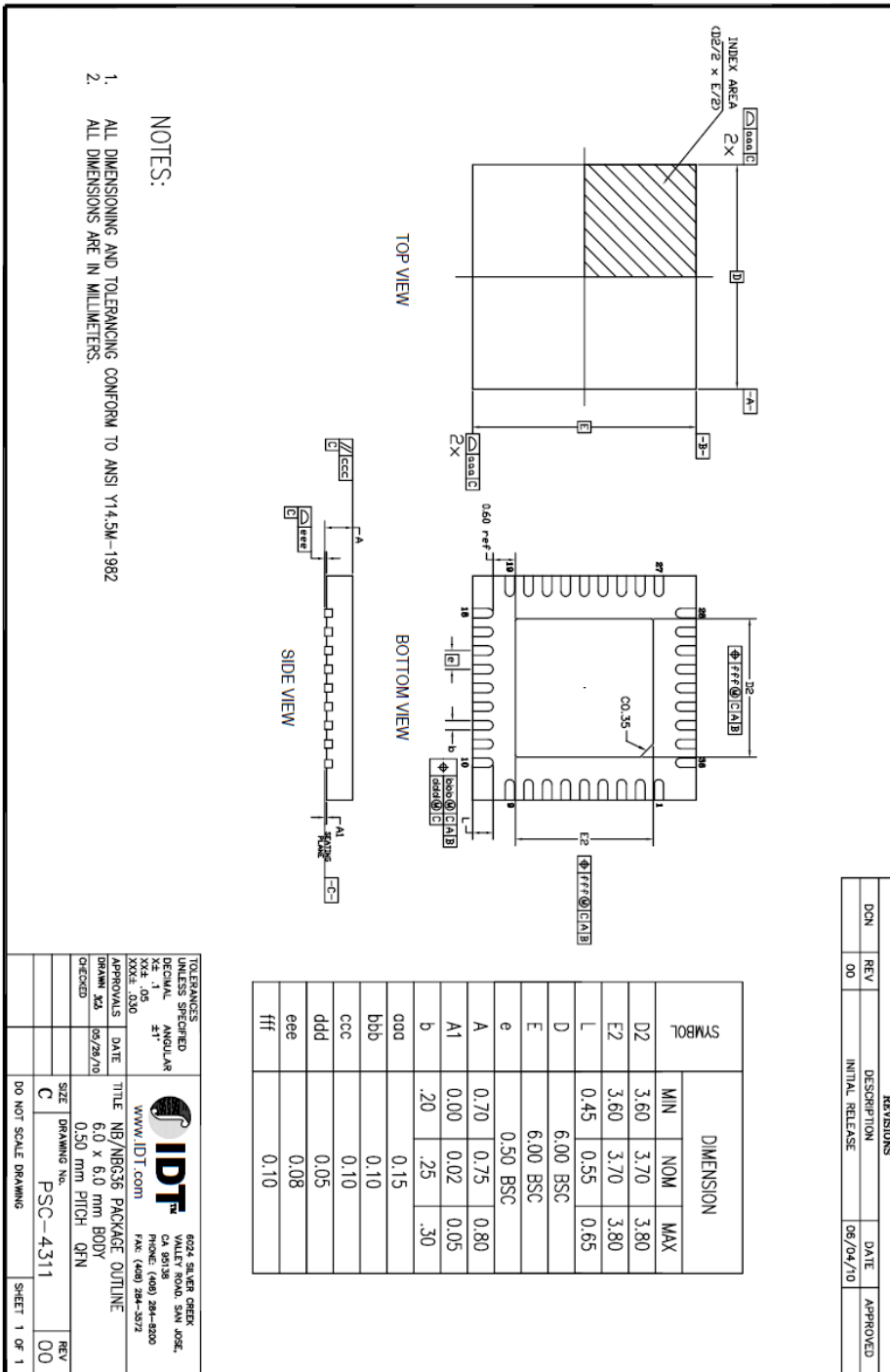

RF to IF Dual Downconverting Mixer

1400 - 2200 MHz F1152NBGI

PINOUTS

Black Text denotes recommended external connection

Red Text denotes internal Function or Connection

- DB GND = Downbonded to Paddle
- Internal NC = Pin not connected

**Please Note!**

- Only connect to one LO feed
- Choose Either Pin 19 or Pin 27
- Do not connect the unused LO pin to ensure good LO return loss

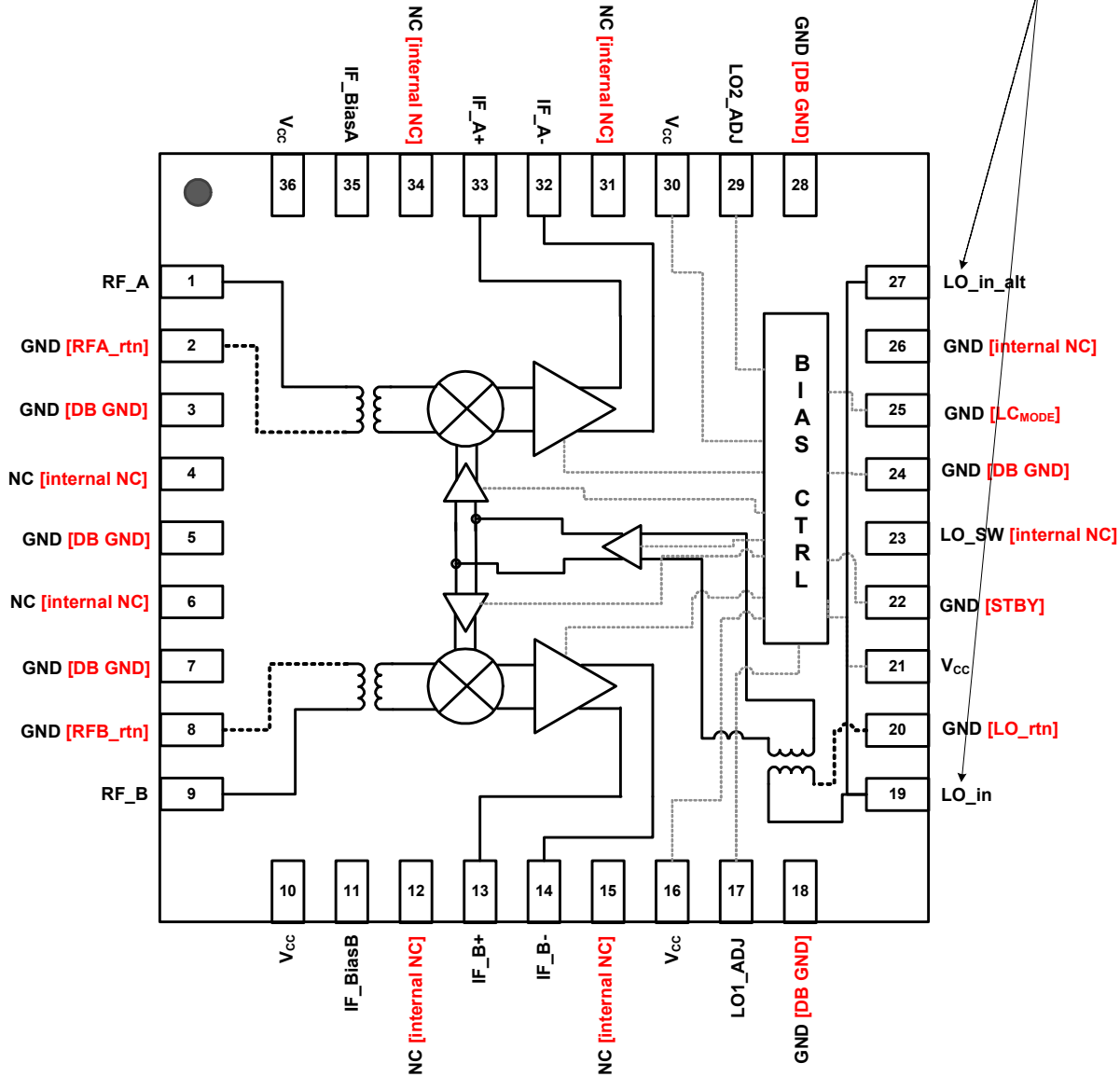



**PIN DESCRIPTIONS**

Pin	Name	Function
1	RF_A	Main Channel RF Input. Internally matched to 50Ω. DO NOT apply DC to these pins
2, 8, 20	RF_Artn, RF_Brtn, LO_rtn	Transformer Ground Returns. Ground these pins.
3, 5, 7, 18, 24, 28	GND	Ground these pins.
4, 6, 12, 15, 31, 23, 26, 34	N.C.	No Connection. Not internally connected. OK to connect to Vcc. OK to connect to GND
10, 16, 21, 30, 36	VCC	Power Supply. Bypass to GND with capacitors shown in the Typical Application Circuit as close as possible to pin.
9	RF_B	Diversity Channel RF Input. Internally matched to 50Ω
11	IF_BiasB	Connect the specified resistor from this pin to ground to set the bias for the Diversity IF amplifier. This is NOT a current set resistor
13, 14	IFB+, IFB-	Diversity Mixer Differential IF Output. Connect pullup inductors from each of these pins to VCC (see the Typical Application Circuit).
17	LO1_ADJ	Connect the specified resistor for either Standard or LC mode from this pin to ground to set the LO common buffer Icc
19, 27	LO_in LO_in_alt	Local Oscillator Input. Connect the LO to this port through the recommended coupling capacitor. <b>Note that you can only drive one LO port at a time. Remove the series capacitor from the unused port.</b>
25	LC_MODE	Low Current Mode. Set this pin to low or ground for LC mode. Set to high or No-Connect for Standard mode. There is an internal pull-up resistor.
22	STBY	STBY Mode. Pull this pin high for Standby mode (~20 mA). Pull low or Ground for normal Operation
29	LO2_ADJ	Connect the specified resistor for either Standard or LC mode from this pin to ground to set the LO drive buffers Icc
32, 33	IFA-, IFA+	Main Mixer Differential IF Output. Connect pullup inductors from each of these pins to VCC (see the Typical Application Circuit).
35	IF_BiasA	Connect the specified resistor from this pin to ground to set the bias for the Main IF amplifier. This is NOT a current set resistor
	— EP	Exposed Pad. Internally connected to GND. Solder this exposed pad to a PCB pad that uses multiple ground vias to provide heat transfer out of the device into the PCB ground planes. These multiple via grounds are also required to achieve the noted RF performance.

EVKIT SCHEMATIC

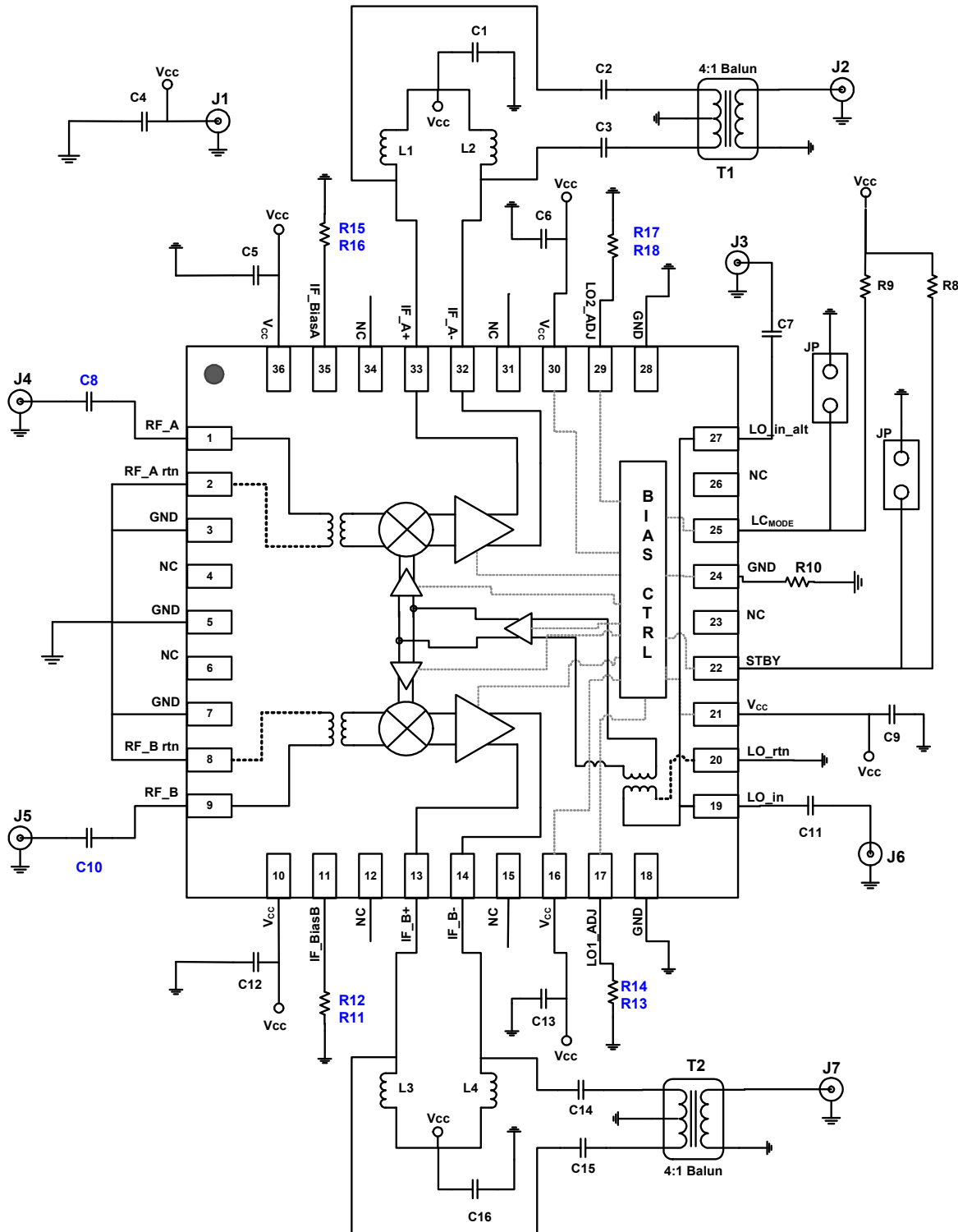

**EVKIT PICTURE/LAYOUT/OPERATION**

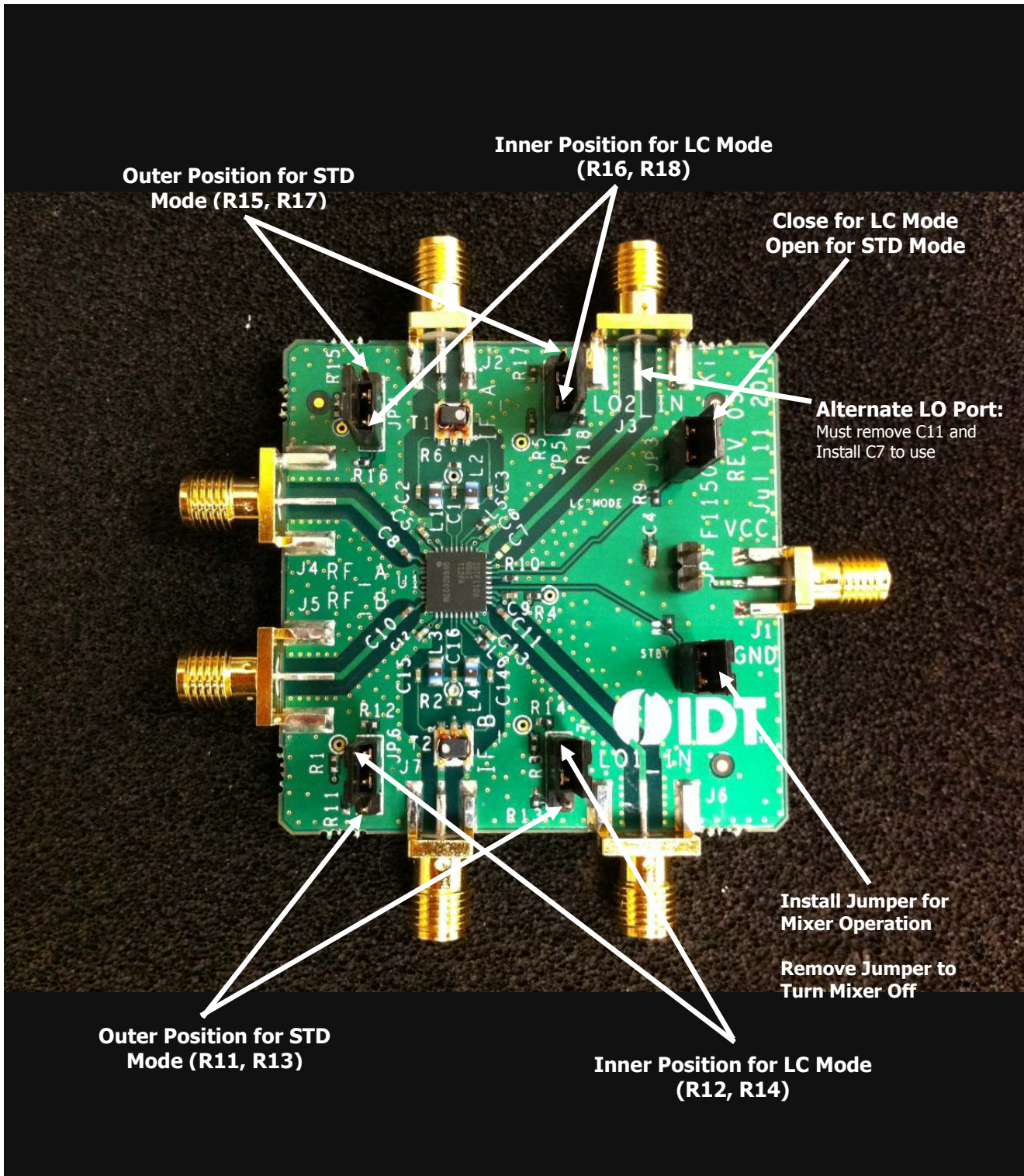

RF to IF Dual Downconverting Mixer

1400 - 2200 MHz F1152NBGI

**EVKIT BOM**

For Standard Mode, Open the LC<sub>MODE</sub> jumper in conjunction with positioning the 4 dual jumpers to select the resistors in **red**.

For Low Current Mode close the LC<sub>MODE</sub> jumper in conjunction with positioning the 4 dual jumpers to select the resistors in **blue**.

**F1152 BOM**

Item #	Value	Size	Desc	Mfr. Part #	Mfr.	Part Reference	Qty
1	10nF	0402	CAP CER 10000PF 16V 10% X7R 0402	GRM155R71C103KA01D	MURATA	C1,5,6,9,12,13,16	7
2	1000pF	0402	CAP CER 1000PF 50V COG 0402	GRM1555C1H102JA01D	MURATA	C2,3,14,15	4
3	39pF	0402	CAP CER 39PF 50V 5% COG 0402	GRM1555C1H390JZ010	MURATA	C8,10,11	3
4	6pF	0402	<i>Note: C7 and C11 cannot be installed together. C7 for Pin27 LO feed. C11 for Pin19 LO feed.</i>			C7	1
5	10uF	0603	CAP CER 10UF 6.3V X5R 0603	GRM188R60J106ME47D	MURATA	C4	1
6	Header 2 Pin	TH 2	CONN HEADER VERT SGL 2POS GOLD	961102-6404-AR	3M	JP1,2,3	3
7	Header 3 Pin	TH 3	CONN HEADER VERT SGL 3POS GOLD	961103-6404-AR	3M	JP4,5,6,7	4
8	SMA_END_LAUNCH	062	SMA_END_LAUNCH	142-0711-821	Emerson Johnson	J1,2,3,4,5,6,7	7
9	270nH	0805	0805CS (2012) Ceramic Chip Inductor	0805CS-271XJLB	COILCRAFT	L1,2,3,4	4
10	27	0402	RES 27 OHM 1/10W 1% 0402 SMD	ERJ-2RKF27R0X	Panasonic	R11,15	2
11	63	0402	RES 63 OHM 1/10W 1% 0402 SMD	ERJ-2RKF63R0X	Panasonic	R12,16	2
12	220	0402	RES 220 OHM 1/10W 1% 0402 SMD	ERJ-2RKF2200X	Panasonic	R13	1
13	240	0402	RES 240 OHM 1/10W 1% 0402 SMD	ERJ-2RKF2400X	Panasonic	R14	1
14	2.15K	0402	RES 2.15K OHM 1/10W 1% 0402 SMD		Panasonic	R18	1
15	1.3K	0402	RES 1.3K OHM 1/10W 1% 0402 SMD	ERJ-2RKF1311X	Panasonic	R17	1
16	47K	0402	RES 47.0K OHM 1/16W 1% 0402 SMD	RC0402FR-0747KL	Yageo	R8,9	2
17	0	0402	RES 0.0 OHM 1/10W 0402 SMD	ERJ-2GE0R00X	Panasonic	R1,2,3,4,5,6,7,10	10
18	4:1 Balun	SM-22	4:1 Center Tap Balun	TC4-1TG2+	Mini Circuits	T1,2	2
19	F1152 (Date Code >= 1201)	QFN-36	Diversity Downconverter	IDTF1152NBGI	IDT	U1	1
20	PCB			F1152 EVKit Rev5			1

**RF Matching for High Side Injection (1400 – 1700 MHz Bands 11, 21, 24)**

See Graphs on Pages 12, 13

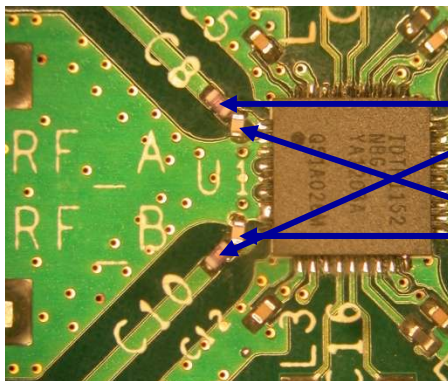

**Change C8 and C10 to 4.3 nH**

**Scrape Trace Resist and add shunt 0.5 pF**

**TOPMARKINGS**

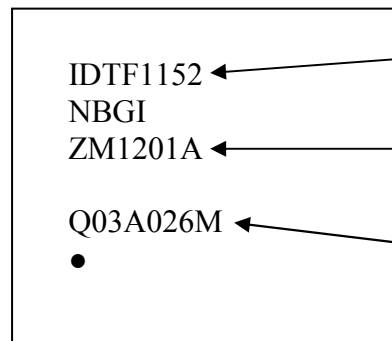

Part Number

Date Code: [xxYYWWx]  
(Work Week 1 of 2012)

Lot Code

**NOTE: Production Devices are DateCode 1201 or later.**

Компания «Океан Электроники» предлагает заключение долгосрочных отношений при поставках импортных электронных компонентов на взаимовыгодных условиях!

Наши преимущества:

- Поставка оригинальных импортных электронных компонентов напрямую с производств Америки, Европы и Азии, а так же с крупнейших складов мира;
- Широкая линейка поставок активных и пассивных импортных электронных компонентов (более 30 млн. наименований);
- Поставка сложных, дефицитных, либо снятых с производства позиций;
- Оперативные сроки поставки под заказ (от 5 рабочих дней);
- Экспресс доставка в любую точку России;
- Помощь Конструкторского Отдела и консультации квалифицированных инженеров;
- Техническая поддержка проекта, помощь в подборе аналогов, поставка прототипов;
- Поставка электронных компонентов под контролем ВП;
- Система менеджмента качества сертифицирована по Международному стандарту ISO 9001;
- При необходимости вся продукция военного и аэрокосмического назначения проходит испытания и сертификацию в лаборатории (по согласованию с заказчиком);
- Поставка специализированных компонентов военного и аэрокосмического уровня качества (Xilinx, Altera, Analog Devices, Intersil, Interpoint, Microsemi, Actel, Aeroflex, Peregrine, VPT, Syfer, Eurofarad, Texas Instruments, MS Kennedy, Miteq, Cobham, E2V, MA-COM, Hittite, Mini-Circuits, General Dynamics и др.);

Компания «Океан Электроники» является официальным дистрибьютором и эксклюзивным представителем в России одного из крупнейших производителей разъемов военного и аэрокосмического назначения «**JONHON**», а так же официальным дистрибьютором и эксклюзивным представителем в России производителя высокотехнологичных и надежных решений для передачи СВЧ сигналов «**FORSTAR**».



## JONHON

«**JONHON**» (основан в 1970 г.)

Разъемы специального, военного и аэрокосмического назначения:

(Применяются в военной, авиационной, аэрокосмической, морской, железнодорожной, горно- и нефтедобывающей отраслях промышленности)

«**FORSTAR**» (основан в 1998 г.)

ВЧ соединители, коаксиальные кабели, кабельные сборки и микроволновые компоненты:

(Применяются в телекоммуникациях гражданского и специального назначения, в средствах связи, РЛС, а так же военной, авиационной и аэрокосмической отраслях промышленности).



Телефон: 8 (812) 309-75-97 (многоканальный)

Факс: 8 (812) 320-03-32

Электронная почта: [ocean@oceanchips.ru](mailto:ocean@oceanchips.ru)

Web: <http://oceanchips.ru/>

Адрес: 198099, г. Санкт-Петербург, ул. Калинина, д. 2, корп. 4, лит. А