

DESCRIPTION

The MPQ2143 is a monolithic, step-down, switch-mode converter with internal power MOSFETs. It can achieve up to 3A continuous output current from a 2.5V-to-5.5V input voltage with excellent load and line regulation. The output voltage can be regulated as low as 0.6V.

Constant-on-time control provides fast transient response and eases loop stabilization. Fault-condition protections include cycle-by-cycle current limiting and thermal shutdown.

The MPQ2143 is available in small TSOT23-8 package and requires only a minimal number of readily-available standard external components.

The MPQ2143 is ideal for a wide range of applications including high-performance DSPs, FPGAs, smartphones, portable instruments, and DVD drivers.

FEATURES

- Guaranteed Industrial/Automotive Temp
- Wide 2.5V-to-5.5V Operating Input Range
- Output Voltage as Low as 0.6V
- 100% Duty Cycle in Dropout
- Up to 3A Output Current
- Low I_Q: 40μA
- 80mΩ and 40mΩ Internal Power MOSFET Switches
- Default 1.2MHz Switching Frequency
- EN and Power-Good for Power Sequencing
- Cycle-by-Cycle Over-Current Protection
- Auto Discharge at Power Off
- Short-Circuit Protect with Hiccup Mode
- Stable with Low-ESR Output Ceramic Capacitors
- Available in a TSOT23-8 Package
- Available in AEC-Q100 Grade 1

APPLICATIONS

- Low Voltage I/O System Power
- Handheld/Battery-powered Systems
- Wireless/Networking Cards

All MPS parts are lead-free, halogen free, and adhere to the RoHS directive. For MPS green status, please visit MPS website under Quality Assurance.
“MPS” and “The Future of Analog IC Technology” are Registered Trademarks of Monolithic Power Systems, Inc.

TYPICAL APPLICATION

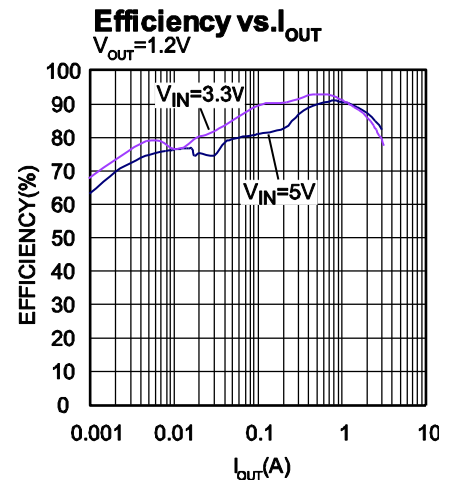
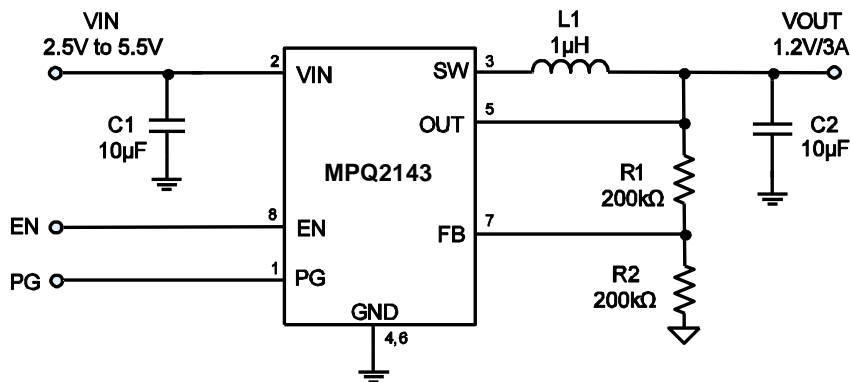

ORDERING INFORMATION

Part Number	Package	Top Marking
MPQ2143DJ*	TSOT23-8	ACE
MPQ2143DJ-AEC1**	TSOT23-8	ACE

* For Tape & Reel, add suffix –Z (e.g. MPQ2143DJ–Z);
For RoHS compliant packaging, add suffix –LF (e.g. MPQ2143DJ–LF–Z)

PACKAGE REFERENCE

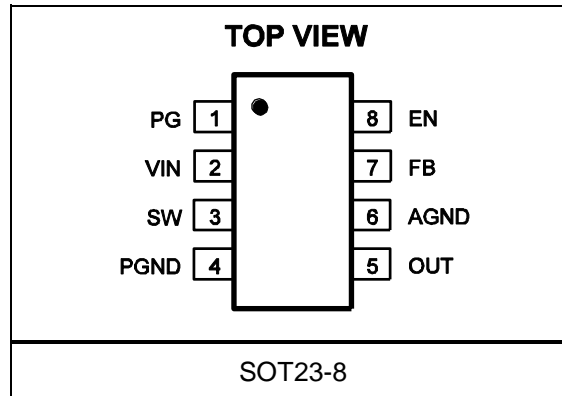

ABSOLUTE MAXIMUM RATINGS ⁽¹⁾

Supply Voltage V _{IN}	6V
V _{SW}	(-3V for < 5ns) to (V _{IN} +0.3V)
All Other Pins.....	-0.3V to +6 V
Junction Temperature.....	150°C
Lead Temperature.....	260°C
Continuous Power Dissipation (T _A = 25°C) ⁽²⁾	1.25W
Storage Temperature.....	-65°C to +150°C

Recommended Operating Conditions ⁽³⁾

Supply Voltage V _{IN}	2.5V to 5.5V
Output Voltage V _{OUT}	0.6V to V _{IN} -0.5V
Operating Junction Temp. (T _J).....	-40°C to +125°C

Thermal Resistance ⁽⁴⁾	θ_{JA}	θ_{JC}
TSOT23-8.....	100.....	55... °C/W

Notes:

- Exceeding these ratings may damage the device.
- The maximum allowable power dissipation is a function of the maximum junction temperature T_J (MAX), the junction-to-ambient thermal resistance θ_{JA} , and the ambient temperature T_A. The maximum allowable continuous power dissipation at any ambient temperature is calculated by P_D (MAX) = (T_J (MAX)-T_A)/ θ_{JA} . Exceeding the maximum allowable power dissipation will cause excessive die temperature, and the regulator will go into thermal shutdown. Internal thermal shutdown circuitry protects the device from permanent damage.
- The device is not guaranteed to function outside of its operating conditions.
- Measured on JESD51-7, 4-layer PCB.

ELECTRICAL CHARACTERISTICS ⁽⁵⁾

V_{IN} = 5V, T_J = 40°C to +125°C, Typical values are at T_J = +25°C, unless otherwise noted.

Parameter	Symbol	Condition	Min	Typ	Max	Units
Feedback Voltage	V _{FB}	2.5V ≤ V _{IN} ≤ 5.5V	-1.5%	0.600	+1.5%	V/%
		T _J = -40°C to +125°C	-2%		+2%	
Feedback Current	I _{FB}	V _{FB} = 0.63V		10		nA
PFET Switch ON Resistance	R _{DSON_P}			65		mΩ
NFET Switch ON Resistance	R _{DSON_N}			40		mΩ
Switch Leakage		V _{EN} = 0V, V _{IN} = 5V, T _J = +25°C		0.1	2	μA
		T _J = -40°C to +125°C			35	
PFET Current Limit		T _J = +25°C	4.2	4.8		A
		T _J = -40°C to +125°C	4.0			
NFET Switch Sinking Current	I _{NSW}	V _{OUT} = 1.2V, V _{FB} = 0.7V		100		μA
ON Time	t _{ON}	V _{IN} = 5V, V _{OUT} = 1.2V		200		nS
		V _{IN} = 3.6V, V _{OUT} = 1.2V		277		
Switching frequency	f _s	V _{IN} = 5V, V _{OUT} = 1.2V, I _{OUT} = 1A	-20%	1200	+20%	kHz
		T _J = -40°C to +125°C	-25%	1200	+25%	
Minimum OFF Time	t _{MIN-OFF}			50		ns
Soft-Start Time	t _{SS-ON}			1.3		ms
Soft-Stop Time	t _{SS-OFF}			1		ms
Power-Good Upper Trip Threshold	PG _H	FB voltage respect to the regulation		+10%		%
Power-Good Lower Trip Threshold	PG _L			-10%		%
Power-Good Delay	PG _D			110		μs
Power-Good Sink Current Capability	V _{PG-L}	Sink 1mA			0.4	V
Power-Good Logic High Voltage	V _{PG-H}	V _{IN} = 5V, V _{FB} = 0.6V, T _J = +25°C	4.9			V
		T _J = -40°C to +125°C	4.85			
Power-Good Internal Pull-Up Resistor	R _{PG}			500		kΩ
Under-Voltage Lockout Threshold Rising			2.0	2.2	2.4	V
Under-Voltage Lockout Threshold Hysteresis				150		mV
EN Input Logic Low Voltage					0.4	V
EN Input Logic High Voltage			1.2			V

ELECTRICAL CHARACTERISTICS ⁽⁵⁾ (continued)

V_{IN} = 5V, T_J = 40°C to + 125°C, Typical values are at T_J = +25°C, unless otherwise noted.

Parameter	Symbol	Condition	Min	Typ	Max	Units
EN Input Current		V _{EN} =2V		2		μ A
		V _{EN} =0V		0.1		μ A
Supply Current (Shutdown)		V _{EN} =0V		0.1		μ A
Supply Current (Quiescent)		V _{EN} =2V, V _{F_{FB}} =0.63V, V _{IN} =3.6V		40		μ A
Thermal Shutdown				150		°C
Thermal Hysteresis				30		°C

Notes:

5) Guaranteed by design.

TYPICAL PERFORMANCE CHARACTERISTICS

V_{IN} = 5V, V_{OUT} = 1.2V, L = 1.0 μ H, C_{OUT}=22 μ F, T_A = 25°C, unless otherwise noted.

Efficiency Vs. I_{out}

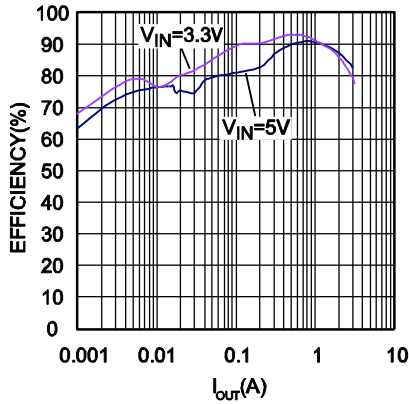

Efficiency Vs. I_{out}

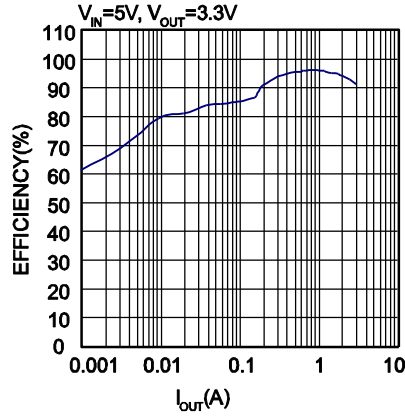

Quiescent Current vs. Input Voltage

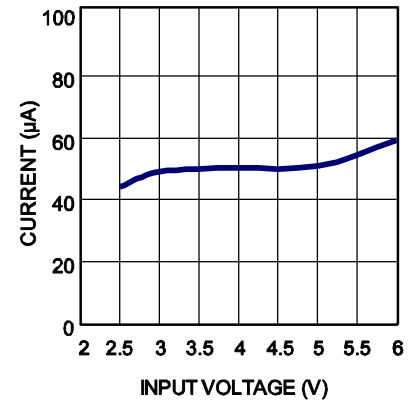

Shutdown Current vs. Input Voltage

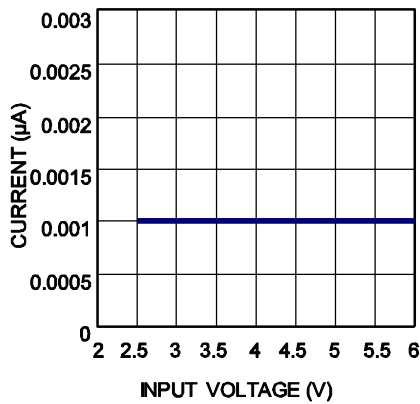

Load Regulation

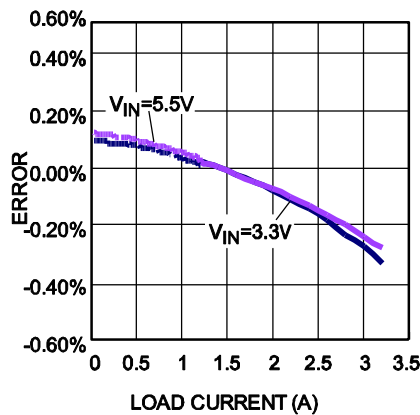

Line Regulation

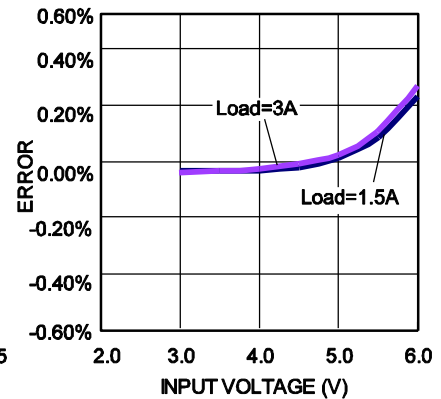

Case Temp Rise

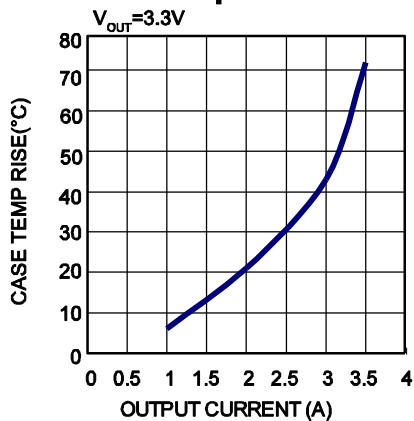

TYPICAL PERFORMANCE CHARACTERISTICS (continued)

V_{IN} = 5V, V_{OUT} = 1.2V, L = 1.0µH, C_{OUT}=22µF, T_A = 25°C, unless otherwise noted

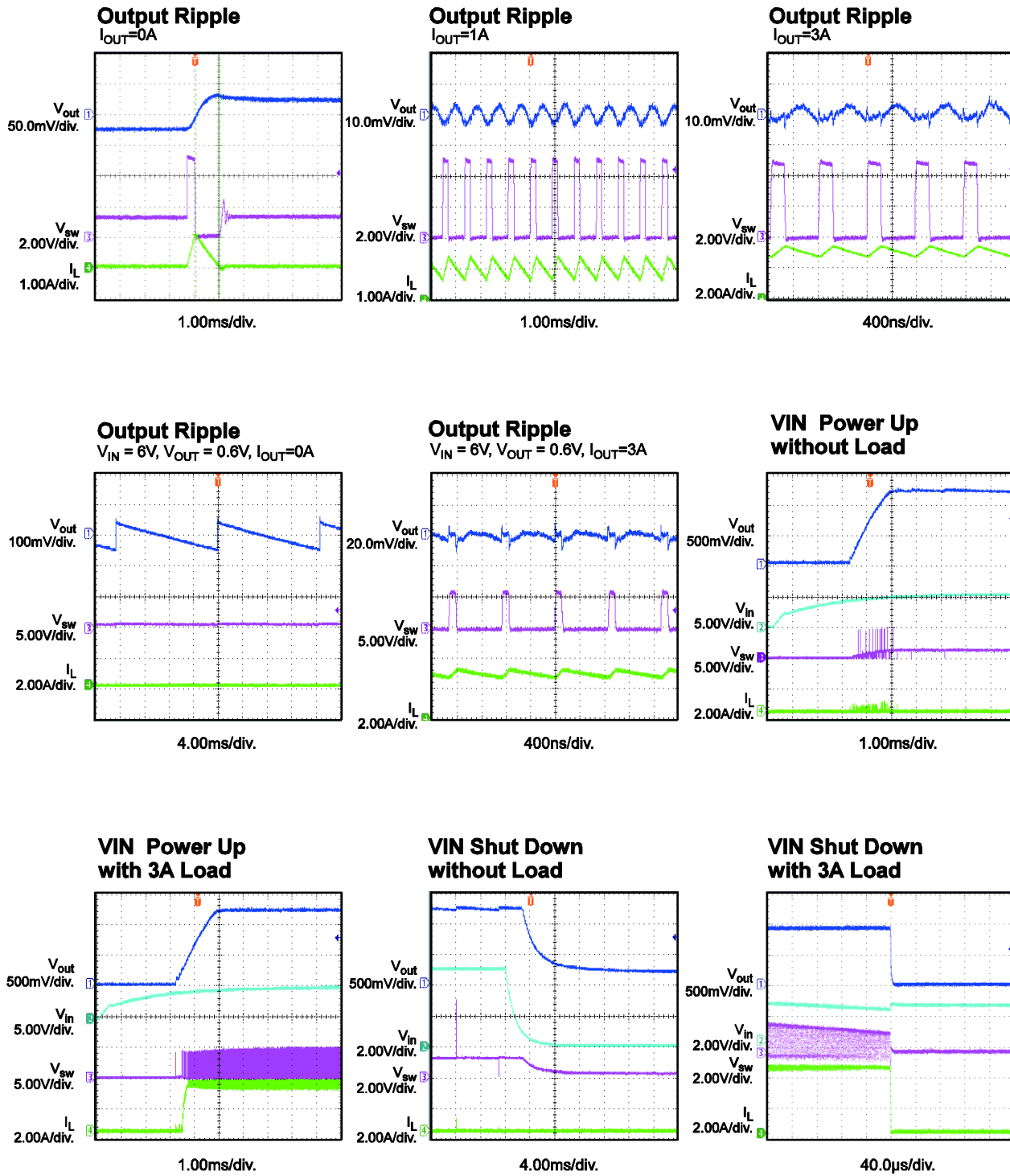

.TYPICAL PERFORMANCE CHARACTERISTICS (continued)

$V_{IN} = 5V$, $V_{OUT} = 1.2V$, $L = 1.0\mu H$, $C_{OUT}=22\mu F$, $T_A = 25^\circ C$, unless otherwise noted.

EN Start Up without Load

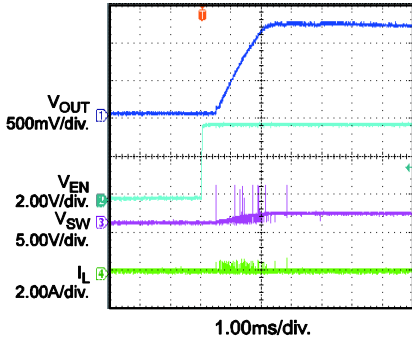

EN Start Up with 3A Load

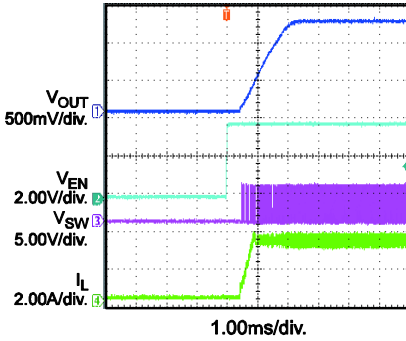

EN Shut Down without Load

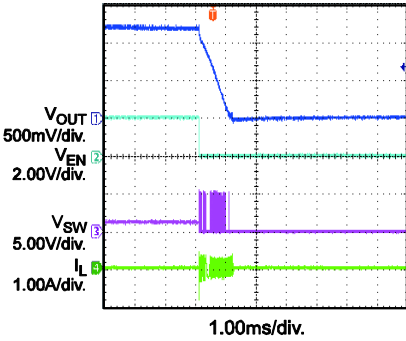

EN Shut Down with 3A Load

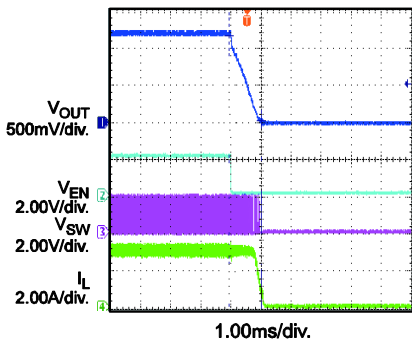

Power Good On without Load

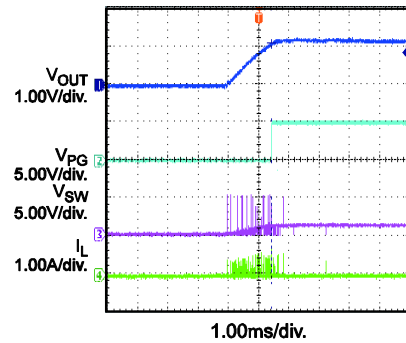

Power Good On with 3A Load

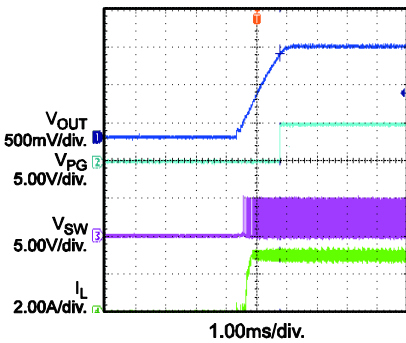

Power Good Off without Load

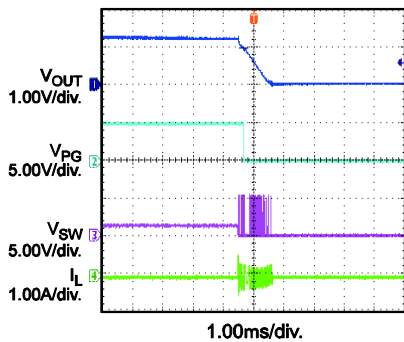

Power Good Off with 3A Load

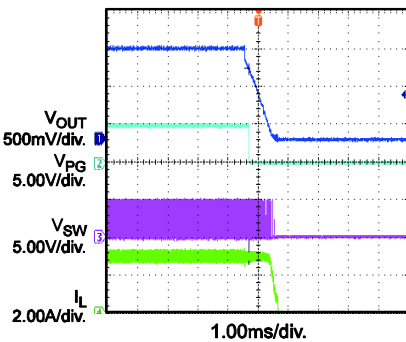

Load Transient Response

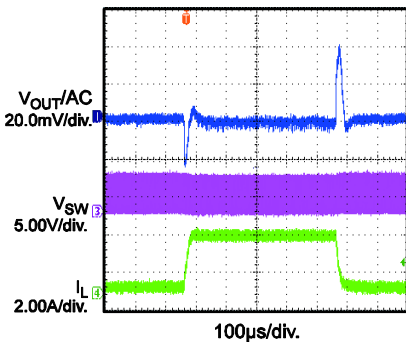

TYPICAL PERFORMANCE CHARACTERISTICS *(continued)*

V_{IN} = 5V, V_{OUT} = 1.2V, L = 1.0 μ H, C_{OUT}=22 μ F, T_A = 25°C, unless otherwise noted.

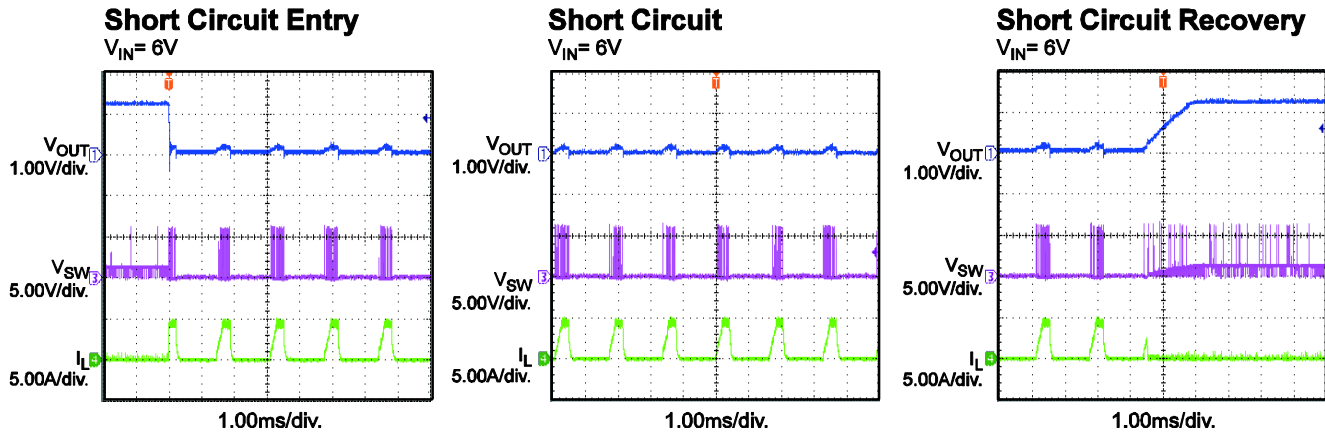

PIN FUNCTIONS

TSOT23 Pin #	Name	Description
1	PG	Power-Good Indicator. The pin output is an open drain that connects to VIN by an internal pull-up resistor. PG is pulled up to VIN when the FB voltage is within 10% of the regulation level. If FB voltage is out of that regulation range, it is LOW.
2	VIN	Supply Voltage. The MPQ2143 operates from a 2.5V-to-5.5V unregulated input. C1 prevents large voltage spikes from appearing at the input.
3	SW	Switch Output
4	PGND	Power Ground
5	OUT	Input Sense. For output voltage feedback
6	AGND	Analog ground. Reference for the internal control circuit.
7	FB	Feedback pin. Connect an external resistor divider from the output to GND to set the output voltage.
8	EN	On/Off Control

FUNCTIONAL BLOCK DIAGRAM

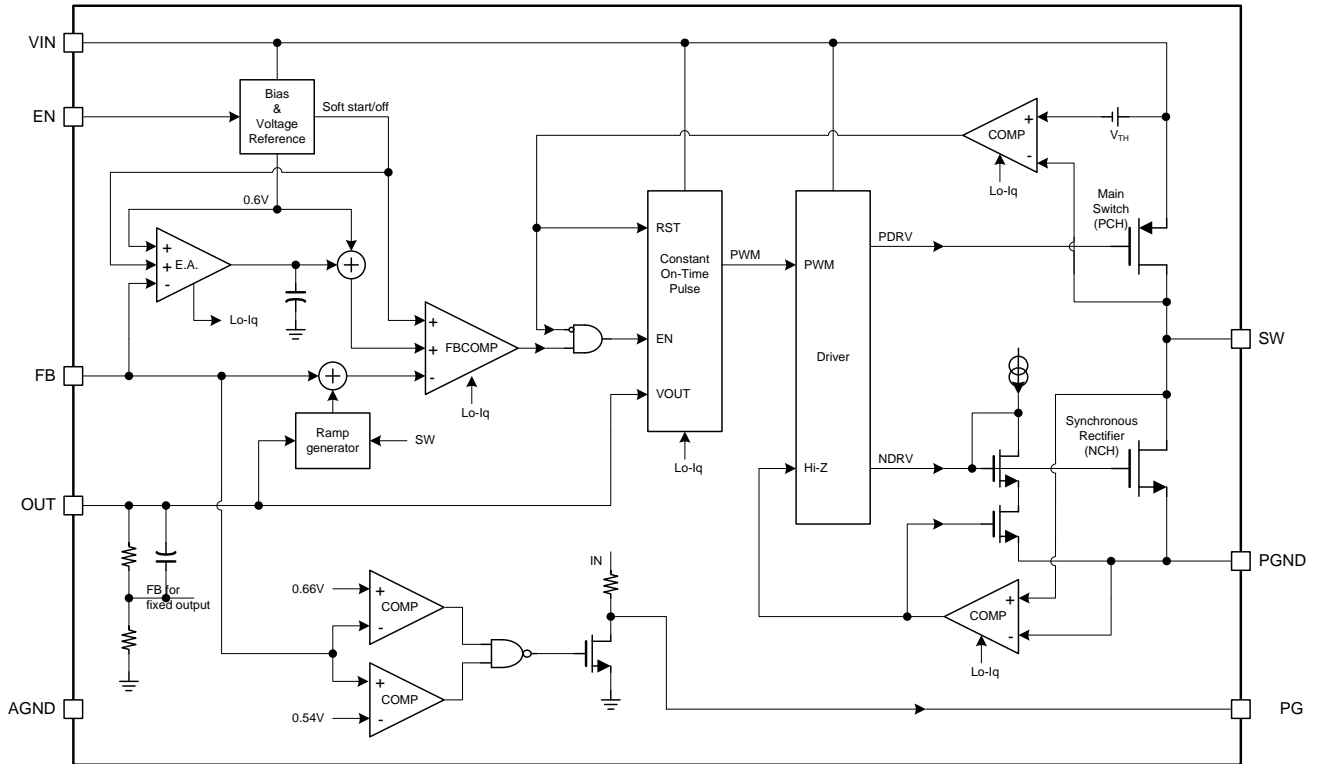

Figure 1: Functional Block Diagram

OPERATION

The MPQ2143 uses constant on-time control with input-voltage feed-forward to stabilize the switching frequency over its full input range. At light load, the MPQ2143 employs a proprietary control over the low-side MOSFET (LS-FET) and inductor current to eliminate ringing on switching node and to improve efficiency.

Constant On-Time Control

When compared to fixed-frequency PWM control, constant on-time control offers a simpler control loop and faster transient response. By using input-voltage feed-forward, the MPQ2143 maintains a nearly constant switching frequency across the entire input and output voltage range. The switching pulse ON time can be estimated as:

$$t_{ON} = \frac{V_{OUT}}{V_{IN}} \cdot 0.833\mu\text{s}$$

To prevent inductor current runaway during the load transient, the MPQ2143 has a fixed minimum OFF time of 50ns. However, this minimum OFF time limit does not affect the operation of the MPQ2143 in steady state in any way.

Light Load Operation

In light load condition, the MPQ2143 uses a proprietary control scheme to save power and improve efficiency: It gradually ramps down the LS-FET current to its minimum instead of turning off the LS-FET immediately when the inductor current starts to reverse. The gradual current drop avoids ringing at the switching node that always occurs in discontinuous conduction mode (DCM) operation.

Enable

When the input voltage exceeds the under-voltage lockout (UVLO) threshold—typically 2.2V—the MPQ2143 is enabled by pulling the EN pin above 1.2V. Leaving the EN pin floating or

grounded will disable the MPQ2143. There is an internal 1MΩ resistor from the EN pin to ground.

Soft-Start/Stop

MPQ2143 has a built-in soft-start that ramps up the output voltage at a constant slew rate that avoids overshooting at startup. The soft-start time is typically about 1ms. When disabled, the MPQ2143 ramps down the internal reference voltage to allow the load to linearly discharge the output.

Power GOOD Indicator

MPQ2143 has an open drain with 500kΩ pull-up resistor pin for power good (PG) indication. When the FB pin is within ±10% of regulation voltage (0.6V), the PG pin is pulled up to V_{IN} by the internal resistor. If the FB pin voltage is outside the ±10% window, the PG pin is pulled to ground by an internal MOSFET. The MOSFET has a maximum R_{dson} of less than 100Ω.

Current limit

The MPQ2143 has a 4.8A current limit for the high side switch (HS-FET). When the HS-FET hits its current limit, the MPQ2143 enters hiccup mode until the current drops to prevent the inductor current from building and possibly damaging the components.

Short Circuit and Recovery

The MPQ2143 also enters short-circuit protection (SCP) mode when it hits the current limit, and tries to recover from the short circuit by entering hiccup mode. In SCP, the MPQ2143 disables the output power stage, discharges a soft-start capacitor, and then enacts a soft-start procedure. If the short-circuit condition still holds after soft-start ends, the MPQ2143 repeats this operation until the short circuit ceases and output rises back to regulation level.

APPLICATION INFORMATION

COMPONENT SELECTION

Setting the Output Voltage

The external resistor divider sets the output voltage (see the Typical Application schematic on page 1). The feedback resistor R1 must account for both stability and dynamic response, and thus can not be too large or too small. Choose an R1 value between 120kΩ and 200kΩ. R2 is then given by:

$$R2 = \frac{R1}{\frac{V_{out}}{0.6} - 1}$$

The feedback circuit is shown as Figure 2.

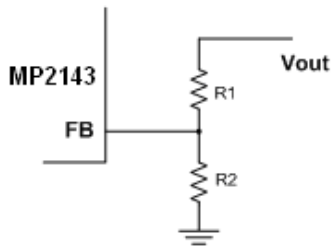

Figure 2: Feedback Network

Table 1 lists the recommended resistors values for common output voltages.

Table 1: Resistor Values for Common Output Voltages

V _{OUT} (V)	R1 (kΩ)	R2 (kΩ)
1.0	200(1%)	300(1%)
1.2	200(1%)	200(1%)
1.8	200(1%)	100(1%)
2.5	200(1%)	63.2(1%)
3.3	200(1%)	44.2(1%)

Selecting the Inductor

A 0.82µH to 4.7µH inductor is recommended for most applications. For highest efficiency, choose an inductor with a DC resistance less than 15mΩ. For most designs, the inductance value can be derived from the following equation.

$$L_1 = \frac{V_{OUT} \times (V_{IN} - V_{OUT})}{V_{IN} \times \Delta I_L \times f_{OSC}}$$

Where ΔI_L is the inductor ripple current.

Choose an inductor current to be approximately 30% of the maximum load current. The maximum inductor peak current is:

$$I_{L(MAX)} = I_{LOAD} + \frac{\Delta I_L}{2}$$

Selecting the Input Capacitor

The input current to the step-down converter is discontinuous, and requires a capacitor to supply the AC current to the step-down converter while maintaining the DC input voltage. Use low-ESR capacitors for the best performance. Ceramic capacitors with X5R or X7R dielectrics are highly recommended because of their low ESR values and small temperature coefficients. For most applications, a 10µF capacitor is sufficient. For higher output voltage, use 47µF to improve system stability.

Since the input capacitor absorbs the input switching current it requires an adequate ripple current rating. The RMS current in the input capacitor can be estimated by:

$$I_{C1} = I_{LOAD} \times \sqrt{\frac{V_{OUT}}{V_{IN}} \times \left(1 - \frac{V_{OUT}}{V_{IN}}\right)}$$

The worse case condition occurs at $V_{IN} = 2V_{OUT}$, where:

$$I_{C1} = \frac{I_{LOAD}}{2}$$

For simplification, choose an input capacitor whose RMS current rating greater than half of the maximum load current.

The input capacitor can be electrolytic, tantalum or ceramic. When using electrolytic or tantalum capacitors, use a small high-quality ceramic capacitor (0.1µF), placed as close to the IC as possible. When using ceramic capacitors, make sure that they have enough capacitance to prevent excessive voltage ripple at input. The input voltage ripple caused by capacitance can be estimated by:

$$\Delta V_{IN} = \frac{I_{LOAD}}{f_s \times C1} \times \frac{V_{OUT}}{V_{IN}} \times \left(1 - \frac{V_{OUT}}{V_{IN}}\right)$$

Selecting the Output Capacitor

The output capacitor (C2) maintains the output DC voltage. Use ceramic capacitors. Low-ESR capacitors keep the output voltage ripple low. The output voltage ripple can be estimated by:

$$\Delta V_{OUT} = \frac{V_{OUT}}{f_s \times L_1} \times \left(1 - \frac{V_{OUT}}{V_{IN}}\right) \times \left(R_{ESR} + \frac{1}{8 \times f_s \times C2}\right)$$

Where L₁ is the inductor value and R_{ESR} is the equivalent series resistance of the output capacitor.

Using ceramic capacitors, the impedance at the switching frequency is dominated by the capacitance. The output voltage ripple is mainly caused by the capacitance. For simplification, the output voltage ripple can be estimated by:

$$\Delta V_{OUT} = \frac{V_{OUT}}{8 \times f_s^2 \times L_1 \times C2} \times \left(1 - \frac{V_{OUT}}{V_{IN}}\right)$$

For tantalum or electrolytic capacitors, the ESR dominates the impedance at the switching frequency. For simplification, the output ripple can be approximated as:

$$\Delta V_{OUT} = \frac{V_{OUT}}{f_s \times L_1} \times \left(1 - \frac{V_{OUT}}{V_{IN}}\right) \times R_{ESR}$$

The characteristics of the output capacitor also affect the stability of the regulation system.

PCB Recommendation of MPQ2143

Proper layout of the switching power supplies is very important, and sometimes critical for proper operation. For high-frequency switching converters, poor layout could lead to poor line or load regulation and stability issues.

The high current paths (GND, IN, and SW) should be placed very close to the device using short, direct, and wide traces. The input capacitor needs to be as close as possible to the IN and GND pins. The external feedback resistors should be placed next to the FB pin. Keep the switching node SW short and away from the feedback network.

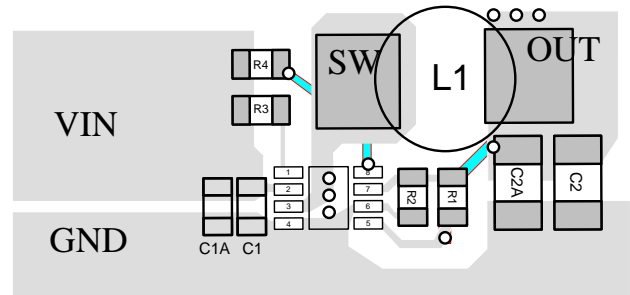

Figure 3: Layout Recommendation

TYPICAL APPLICATION CIRCUITS

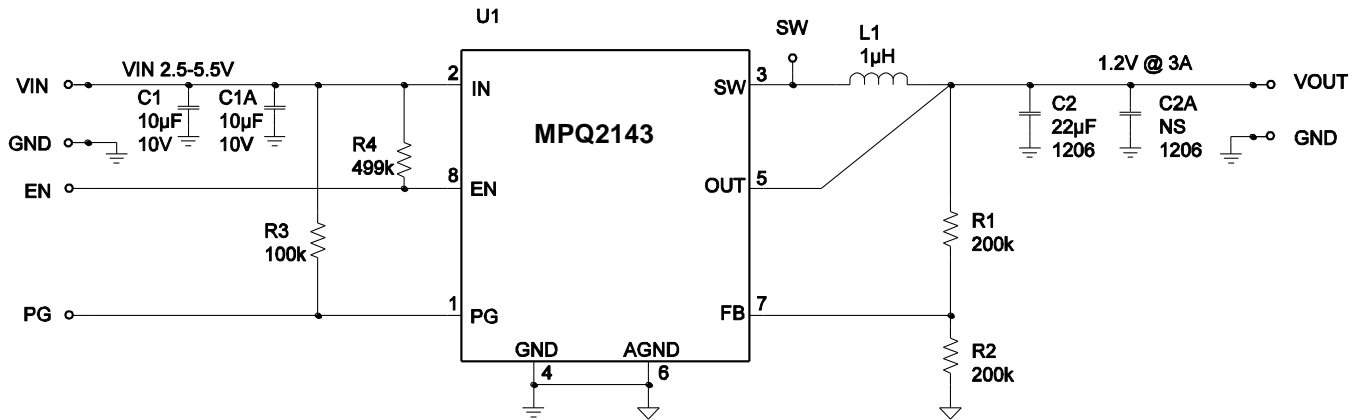
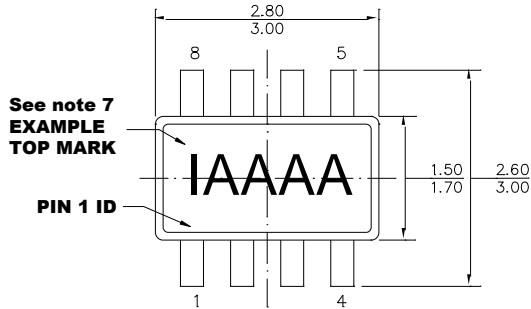

Figure 4: MPQ2143 Typical Application Circuit

PACKAGE INFORMATION

TSOT23-8



TOP VIEW

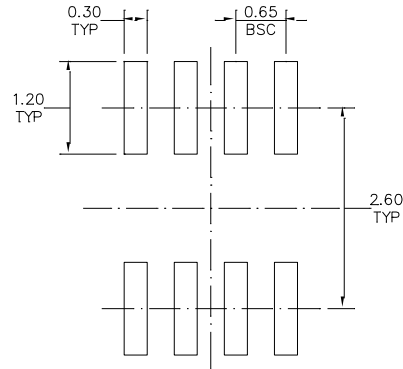

RECOMMENDED LAND PATTERN

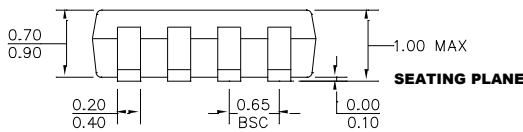

FRONT VIEW

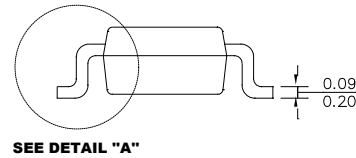

SIDE VIEW

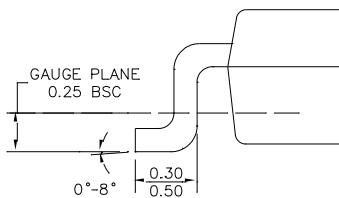

DETAIL "A"

NOTE:

- 1) ALL DIMENSIONS ARE IN MILLIMETERS.
- 2) PACKAGE LENGTH DOES NOT INCLUDE MOLD FLASH, PROTRUSION OR GATE BURR.
- 3) PACKAGE WIDTH DOES NOT INCLUDE INTERLEAD FLASH OR PROTRUSION.
- 4) LEAD COPLANARITY (BOTTOM OF LEADS AFTER FORMING) SHALL BE 0.10 MILLIMETERS MAX.
- 5) JEDEC REFERENCE IS MO-193, VARIATION BA.
- 6) DRAWING IS NOT TO SCALE.
- 7) PIN 1 IS LOWER LEFT PIN WHEN READING TOP MARK FROM LEFT TO RIGHT, (SEE EXAMPLE TOP MARK)

NOTICE: The information in this document is subject to change without notice. Please contact MPS for current specifications. Users should warrant and guarantee that third party Intellectual Property rights are not infringed upon when integrating MPS products into any application. MPS will not assume any legal responsibility for any said applications.

Компания «Океан Электроники» предлагает заключение долгосрочных отношений при поставках импортных электронных компонентов на взаимовыгодных условиях!

Наши преимущества:

- Поставка оригинальных импортных электронных компонентов напрямую с производств Америки, Европы и Азии, а так же с крупнейших складов мира;
- Широкая линейка поставок активных и пассивных импортных электронных компонентов (более 30 млн. наименований);
- Поставка сложных, дефицитных, либо снятых с производства позиций;
- Оперативные сроки поставки под заказ (от 5 рабочих дней);
- Экспресс доставка в любую точку России;
- Помощь Конструкторского Отдела и консультации квалифицированных инженеров;
- Техническая поддержка проекта, помощь в подборе аналогов, поставка прототипов;
- Поставка электронных компонентов под контролем ВП;
- Система менеджмента качества сертифицирована по Международному стандарту ISO 9001;
- При необходимости вся продукция военного и аэрокосмического назначения проходит испытания и сертификацию в лаборатории (по согласованию с заказчиком);
- Поставка специализированных компонентов военного и аэрокосмического уровня качества (Xilinx, Altera, Analog Devices, Intersil, Interpoint, Microsemi, Actel, Aeroflex, Peregrine, VPT, Syfer, Eurofarad, Texas Instruments, MS Kennedy, Miteq, Cobham, E2V, MA-COM, Hittite, Mini-Circuits, General Dynamics и др.);

Компания «Океан Электроники» является официальным дистрибьютором и эксклюзивным представителем в России одного из крупнейших производителей разъемов военного и аэрокосмического назначения «**JONHON**», а так же официальным дистрибьютором и эксклюзивным представителем в России производителя высокотехнологичных и надежных решений для передачи СВЧ сигналов «**FORSTAR**».



JONHON

«**JONHON**» (основан в 1970 г.)

Разъемы специального, военного и аэрокосмического назначения:

(Применяются в военной, авиационной, аэрокосмической, морской, железнодорожной, горно- и нефтедобывающей отраслях промышленности)

«**FORSTAR**» (основан в 1998 г.)

ВЧ соединители, коаксиальные кабели,
кабельные сборки и микроволновые компоненты:

(Применяются в телекоммуникациях гражданского и специального назначения, в средствах связи, РЛС, а так же военной, авиационной и аэрокосмической отраслях промышленности).



Телефон: 8 (812) 309-75-97 (многоканальный)

Факс: 8 (812) 320-03-32

Электронная почта: ocean@oceanchips.ru

Web: <http://oceanchips.ru/>

Адрес: 198099, г. Санкт-Петербург, ул. Калинина, д. 2, корп. 4, лит. А