

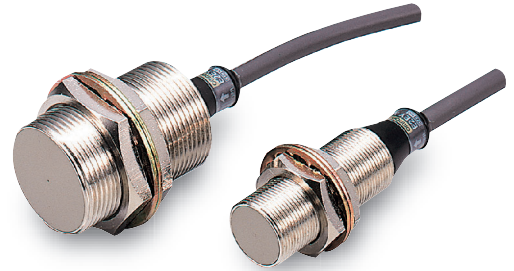

A Proximity Sensor for Non-Ferrous Metals: Aluminum, Brass, etc. Iron Is Not Detected.



- Detects only non-ferrous metals without detecting ferrous metals (such as iron and nickel). (Aluminum foil is also not detected.)
- Built-in amplifier for easy application.
- Easy-to-see detection indicator provided.



 Be sure to read *Safety Precautions* on page 4.

Ordering Information

Sensors

Appearance	Sensing distance		Output configuration/Operation mode	Model
Shielded 	M18	 4 mm	DC 3-wire, NPN NO	E2EY-X4C1 2M
	M30	 8 mm		E2EY-X8C1 2M

Accessories (Order Separately)

[Mounting Brackets](#)

[Protective Covers](#)

[Sputter Protective Covers](#)

Refer to Y92□ for details.

Ratings and Specifications

Item	Model	E2EY-X4C1	E2EY-X8C1
Sensing distance		4 mm \pm 10%	8 mm \pm 10%
Set distance		0 to 2.8 mm	0 to 5.6 mm
Differential travel		20% max. of sensing distance	
Detectable object		Non-ferrous metal (Does not detect ferrous metal.)	
Standard sensing object		Aluminum: 18 \times 18 \times 1 mm	Aluminum: 30 \times 30 \times 1 mm
Response frequency *		70 Hz	
Power supply voltage (operating voltage range)		12 to 24 VDC (10 to 30 VDC), ripple (p-p): 10% max.	
Current consumption		20 mA max.	
Control output	Load current	NPN open-collector output, 100 mA max. (at 30 VDC)	
	Residual voltage	2 V max. (Load current: 100 mA, Cable length: 2 m)	
Indicators		Detection indicator (red)	
Operation mode (with sensing object approaching)		Load ON: NO (Refer to the timing charts under <i>I/O Circuit Diagrams</i> on page 3 for details.)	
Protection circuits		Reverse polarity protection, Load short-circuit protection, Surge suppressor	
Ambient temperature range		Operating/Storage: -10 to 55°C (with no icing or condensation)	
Ambient humidity range		Operating/Storage: 35% to 95% (with no condensation)	
Temperature influence		\pm 20% max. of sensing distance at 23°C in the temperature range of -10 to 55°C	
Voltage influence		\pm 2.5% max. of sensing distance at rated voltage in rated voltage \pm 15% range	
Insulation resistance		50 M Ω min. (at 500 VDC) between current-carrying parts and case	
Dielectric strength		1,000 VAC, 50/60 Hz for 1 minute between current-carrying parts and case	
Vibration resistance		Destruction: 10 to 55 Hz, 1.5-mm double amplitude for 2 hours each in X, Y, and Z directions	
Shock resistance		Destruction: 1,000 m/s ² 10 times each in X, Y, and Z directions	
Degree of protection		IEC 60529 IP67, in-house standards: oil-resistant	
Connection method		Pre-wired Models (Standard cable length: 2 m)	
Weight (packed state)		Approx. 140 g	Approx. 190 g
Materials	Case	Nickel-plated brass	
	Sensing surface	Heat-resistant ABS	
	Clamping nuts	Nickel-plated brass	
	Toothed washer	Zinc-plated iron	
Accessories		---	

* The response frequency is an average value. Measurement conditions are as follows: standard sensing object, a distance of twice the standard sensing object, and a set distance of half the sensing distance.

Engineering Data (Typical)

Sensing Area

E2EY-X4C1

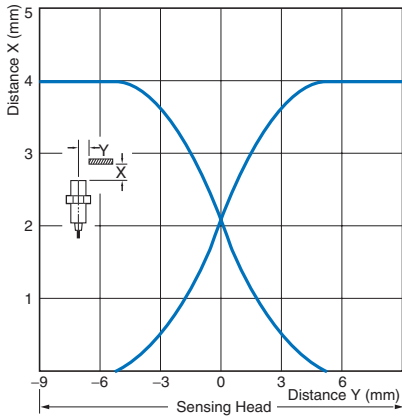

E2EY-X8C1

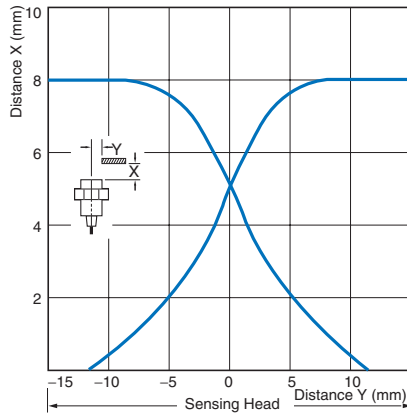

Influence of Sensing Object Size and Material

E2EY-X4C1

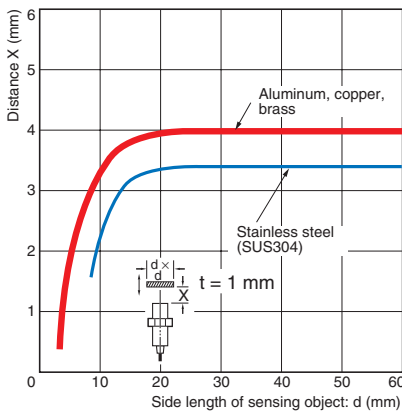

E2EY-X8C1

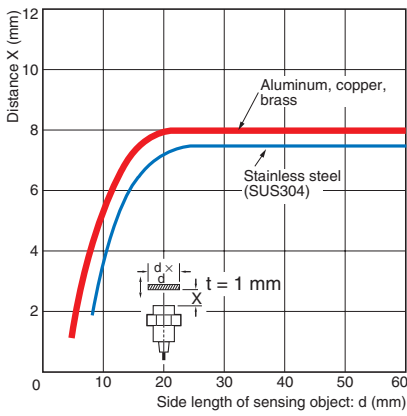

I/O Circuit Diagrams

DC 3-Wire Models

Operation mode	Model	Timing chart	Output circuit
NO	E2EY-X4C1 E2EY-X8C1	<p>Sensing object Present </p> <p>Not present </p> <p>Output transistor (load) ON </p> <p>OFF </p> <p>Detection indicator (red) ON </p> <p>OFF </p>	<p>* Load current: 100 mA max.</p>

Safety Precautions

Refer to *Warranty and Limitations of Liability*.

⚠ WARNING

This product is not designed or rated for ensuring safety of persons either directly or indirectly. Do not use it for such purposes.



Precautions for Correct Use

Do not use this product under ambient conditions that exceed the ratings.

● Design

Influence of Surrounding Metal

When mounting the Sensor within a metal panel, ensure that the clearances given in the following table are maintained. Failure to maintain these distances may cause deterioration in the performance of the Sensor.

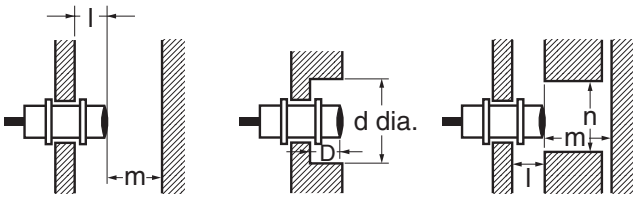

Influence of Surrounding Metal

(Unit: mm)

Model	Item	l	d	D	m	n
E2EY-X4C1	0	0	18	0	20	27
E2EY-X8C1			30		40	45

Mutual Interference

When installing Sensors face-to-face or side-by-side, ensure that the minimum distances given in the following table are maintained.

Mutual Interference (Unit: mm)

Model	Item	A	B
E2EY-X4C1		50	35
E2EY-X8C1		100	70

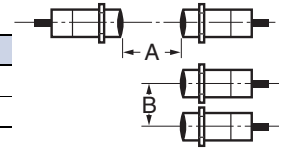

Note: Aluminum (non-ferrous metal) cannot be detected through iron (ferrous metal).

Mounting

Do not tighten the nut with excessive force. A toothed washer must be used with the nut.

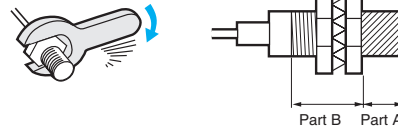

Note: 1. The allowable tightening strength depends on the distance from the edge of the head, as shown in the following table. (A is the distance from the edge of the head. B includes the nut on the head side. If the edge of the nut is in part A, the tightening torque for part A applies instead.)

2. The following torque assume washers are being used.

Model	Tightening Torque	Part A		Part B
		Dimension (mm)	Torque	Torque
E2EY-X4C1		22	15 N·m	49 N·m
E2EY-X8C1		26	39 N·m	78 N·m

Dimensions

(Unit: mm)
Tolerance class IT16 applies to dimensions in this data sheet unless otherwise specified.

E2EY-X4C1

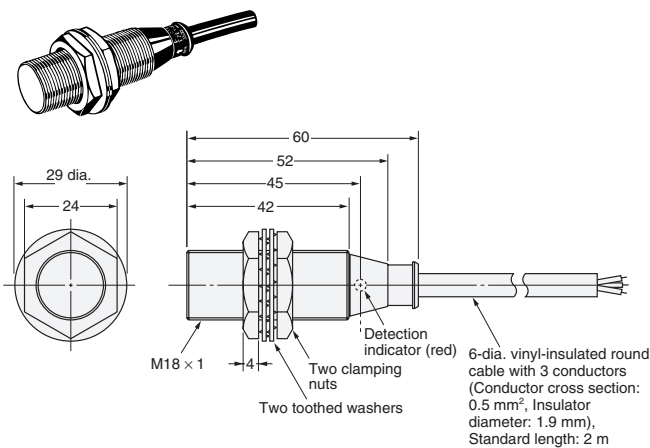

E2EY-X8C1

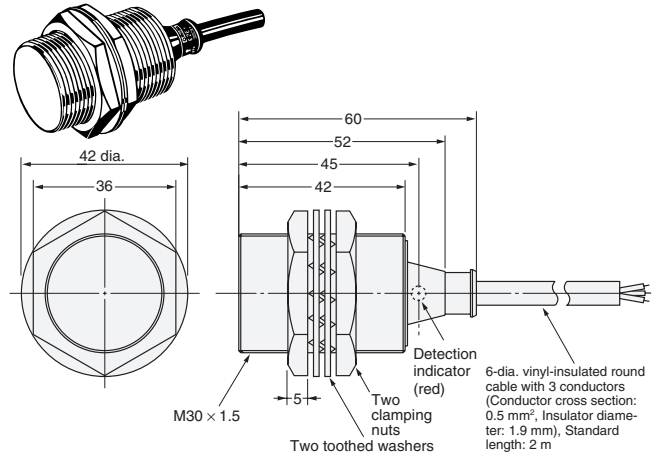

Mounting Hole Dimensions

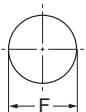

Model	F (mm)
E2EY-X4C1	18.5 ⁺⁵ ₀ dia.
E2EY-X8C1	30.5 ⁺⁵ ₀ dia.

Read and Understand This Catalog

Please read and understand this catalog before purchasing the products. Please consult your OMRON representative if you have any questions or comments.

Warranty and Limitations of Liability

WARRANTY

OMRON's exclusive warranty is that the products are free from defects in materials and workmanship for a period of one year (or other period if specified) from date of sale by OMRON.

OMRON MAKES NO WARRANTY OR REPRESENTATION, EXPRESS OR IMPLIED, REGARDING NON-INFRINGEMENT, MERCHANTABILITY, OR FITNESS FOR PARTICULAR PURPOSE OF THE PRODUCTS. ANY BUYER OR USER ACKNOWLEDGES THAT THE BUYER OR USER ALONE HAS DETERMINED THAT THE PRODUCTS WILL SUITABLY MEET THE REQUIREMENTS OF THEIR INTENDED USE. OMRON DISCLAIMS ALL OTHER WARRANTIES, EXPRESS OR IMPLIED.

LIMITATIONS OF LIABILITY

OMRON SHALL NOT BE RESPONSIBLE FOR SPECIAL, INDIRECT, OR CONSEQUENTIAL DAMAGES, LOSS OF PROFITS OR COMMERCIAL LOSS IN ANY WAY CONNECTED WITH THE PRODUCTS, WHETHER SUCH CLAIM IS BASED ON CONTRACT, WARRANTY, NEGLIGENCE, OR STRICT LIABILITY.

In no event shall the responsibility of OMRON for any act exceed the individual price of the product on which liability is asserted.

IN NO EVENT SHALL OMRON BE RESPONSIBLE FOR WARRANTY, REPAIR, OR OTHER CLAIMS REGARDING THE PRODUCTS UNLESS OMRON'S ANALYSIS CONFIRMS THAT THE PRODUCTS WERE PROPERLY HANDLED, STORED, INSTALLED, AND MAINTAINED AND NOT SUBJECT TO CONTAMINATION, ABUSE, MISUSE, OR INAPPROPRIATE MODIFICATION OR REPAIR.

Application Considerations

SUITABILITY FOR USE

OMRON shall not be responsible for conformity with any standards, codes, or regulations that apply to the combination of products in the customer's application or use of the products.

At the customer's request, OMRON will provide applicable third party certification documents identifying ratings and limitations of use that apply to the products. This information by itself is not sufficient for a complete determination of the suitability of the products in combination with the end product, machine, system, or other application or use.

The following are some examples of applications for which particular attention must be given. This is not intended to be an exhaustive list of all possible uses of the products, nor is it intended to imply that the uses listed may be suitable for the products:

- Outdoor use, uses involving potential chemical contamination or electrical interference, or conditions or uses not described in this catalog.
- Nuclear energy control systems, combustion systems, railroad systems, aviation systems, medical equipment, amusement machines, vehicles, safety equipment, and installations subject to separate industry or government regulations.
- Systems, machines, and equipment that could present a risk to life or property.

Please know and observe all prohibitions of use applicable to the products.

NEVER USE THE PRODUCTS FOR AN APPLICATION INVOLVING SERIOUS RISK TO LIFE OR PROPERTY WITHOUT ENSURING THAT THE SYSTEM AS A WHOLE HAS BEEN DESIGNED TO ADDRESS THE RISKS, AND THAT THE OMRON PRODUCTS ARE PROPERLY RATED AND INSTALLED FOR THE INTENDED USE WITHIN THE OVERALL EQUIPMENT OR SYSTEM.

PROGRAMMABLE PRODUCTS

OMRON shall not be responsible for the user's programming of a programmable product, or any consequence thereof.

Disclaimers

CHANGE IN SPECIFICATIONS

Product specifications and accessories may be changed at any time based on improvements and other reasons.

It is our practice to change model numbers when published ratings or features are changed, or when significant construction changes are made. However, some specifications of the products may be changed without any notice. When in doubt, special model numbers may be assigned to fix or establish key specifications for your application on your request. Please consult with your OMRON representative at any time to confirm actual specifications of purchased products.

DIMENSIONS AND WEIGHTS

Dimensions and weights are nominal and are not to be used for manufacturing purposes, even when tolerances are shown.

PERFORMANCE DATA

Performance data given in this catalog is provided as a guide for the user in determining suitability and does not constitute a warranty. It may represent the result of OMRON's test conditions, and the users must correlate it to actual application requirements. Actual performance is subject to the OMRON Warranty and Limitations of Liability.

ERRORS AND OMISSIONS

The information in this document has been carefully checked and is believed to be accurate; however, no responsibility is assumed for clerical, typographical, or proofreading errors, or omissions.

2008.11

In the interest of product improvement, specifications are subject to change without notice.

OMRON Corporation
Industrial Automation Company

<http://www.ia.omron.com/>

(c)Copyright OMRON Corporation 2008 All Right Reserved.

Компания «Океан Электроники» предлагает заключение долгосрочных отношений при поставках импортных электронных компонентов на взаимовыгодных условиях!

Наши преимущества:

- Поставка оригинальных импортных электронных компонентов напрямую с производств Америки, Европы и Азии, а так же с крупнейших складов мира;
- Широкая линейка поставок активных и пассивных импортных электронных компонентов (более 30 млн. наименований);
- Поставка сложных, дефицитных, либо снятых с производства позиций;
- Оперативные сроки поставки под заказ (от 5 рабочих дней);
- Экспресс доставка в любую точку России;
- Помощь Конструкторского Отдела и консультации квалифицированных инженеров;
- Техническая поддержка проекта, помощь в подборе аналогов, поставка прототипов;
- Поставка электронных компонентов под контролем ВП;
- Система менеджмента качества сертифицирована по Международному стандарту ISO 9001;
- При необходимости вся продукция военного и аэрокосмического назначения проходит испытания и сертификацию в лаборатории (по согласованию с заказчиком);
- Поставка специализированных компонентов военного и аэрокосмического уровня качества (Xilinx, Altera, Analog Devices, Intersil, Interpoint, Microsemi, Actel, Aeroflex, Peregrine, VPT, Syfer, Eurofarad, Texas Instruments, MS Kennedy, Miteq, Cobham, E2V, MA-COM, Hittite, Mini-Circuits, General Dynamics и др.);

Компания «Океан Электроники» является официальным дистрибьютором и эксклюзивным представителем в России одного из крупнейших производителей разъемов военного и аэрокосмического назначения «**JONHON**», а так же официальным дистрибьютором и эксклюзивным представителем в России производителя высокотехнологичных и надежных решений для передачи СВЧ сигналов «**FORSTAR**».



JONHON

«**JONHON**» (основан в 1970 г.)

Разъемы специального, военного и аэрокосмического назначения:

(Применяются в военной, авиационной, аэрокосмической, морской, железнодорожной, горно- и нефтедобывающей отраслях промышленности)

«**FORSTAR**» (основан в 1998 г.)

ВЧ соединители, коаксиальные кабели,
кабельные сборки и микроволновые компоненты:

(Применяются в телекоммуникациях гражданского и специального назначения, в средствах связи, РЛС, а так же военной, авиационной и аэрокосмической отраслях промышленности).



Телефон: 8 (812) 309-75-97 (многоканальный)

Факс: 8 (812) 320-03-32

Электронная почта: ocean@oceanchips.ru

Web: <http://oceanchips.ru/>

Адрес: 198099, г. Санкт-Петербург, ул. Калинина, д. 2, корп. 4, лит. А