



VNP10N06

"OMNIFET": FULLY AUTOPROTECTED POWER MOSFET

TYPE	V _{clamp}	R _{DS(on)}	I _{lim}
VNP10N06	60 V	0.3 Ω	10 A

- LINEAR CURRENT LIMITATION
- THERMAL SHUT DOWN
- SHORT CIRCUIT PROTECTION
- INTEGRATED CLAMP
- LOW CURRENT DRAWN FROM INPUT PIN
- LOGIC LEVEL INPUT THRESHOLD
- ESD PROTECTION
- SCHMITT TRIGGER ON INPUT
- HIGH NOISE IMMUNITY
- STANDARD TO-220 PACKAGE

DESCRIPTION

The VNP10N06 is a monolithic device made using STMicroelectronics VIPower Technology, intended for replacement of standard power MOSFETS in DC to 50 KHz applications.

Built-in thermal shut-down, linear current limitation and overvoltage clamp protect the chip in harsh environments.

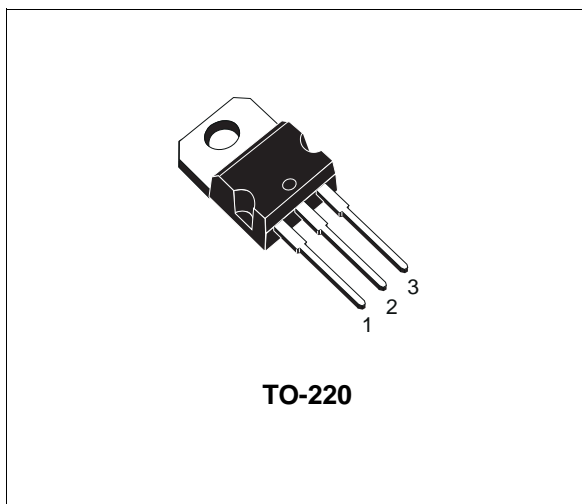

BLOCK DIAGRAM

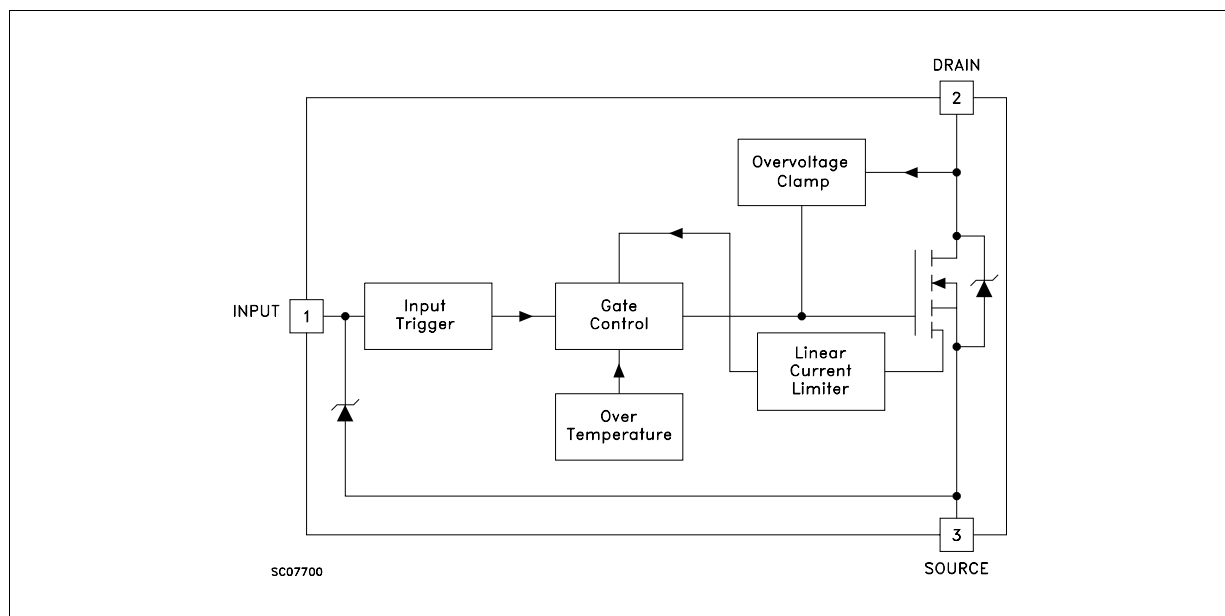

VNP10N06

ABSOLUTE MAXIMUM RATING

Symbol	Parameter	Value	Unit
V _{DS}	Drain-source Voltage (V _{in} = 0)	Internally Clamped	V
V _{in}	Input Voltage	Internally Clamped	V
I _{in}	Input Current	± 20	mA
I _D	Drain Current	Internally Limited	A
I _R	Reverse DC Output Current	-15	A
V _{esd}	Electrostatic Discharge (C= 100 pF, R=1.5 KΩ)	4000	V
P _{tot}	Total Dissipation at T _c = 25 °C	42	W
T _j	Operating Junction Temperature	Internally Limited	°C
T _c	Case Operating Temperature	Internally Limited	°C
T _{stg}	Storage Temperature	-55 to 150	°C

THERMAL DATA

R _{thj-case}	Thermal Resistance Junction-case	Max	3	°C/W
R _{thj-amb}	Thermal Resistance Junction-ambient	Max	62.5	°C/W

ELECTRICAL CHARACTERISTICS (T_{case} = 25 °C unless otherwise specified)

OFF

Symbol	Parameter	Test Conditions	Min.	Typ.	Max.	Unit
V _{CLAMP}	Drain-source Clamp Voltage	I _D = 200 mA V _{in} = 0	50	60	70	V
V _{IL}	Input Low Level Voltage	I _D = 100 μA V _{DS} = 16 V			1.5	V
V _{IH}	Input High Level Voltage	R _L = 27 Ω V _{DD} = 16 V V _{DS} = 0.5 V	3.2			V
V _{INCL}	Input-Source Reverse Clamp Voltage	I _{in} = -1 mA I _{in} = 1 mA	-1 8		-0.3 11	V V
I _{DSS}	Zero Input Voltage Drain Current (V _{in} = 0)	V _{DS} = 50 V V _{in} = V _{IL} V _{DS} < 35 V V _{in} = V _{IL}			250 100	μA μA
I _{ISS}	Supply Current from Input Pin	V _{DS} = 0 V V _{in} = 5 V		150	300	μA

ON (*)

Symbol	Parameter	Test Conditions	Min.	Typ.	Max.	Unit
R _{DS(on)}	Static Drain-source On Resistance	V _{in} = 7 V I _D = 1 A T _J < 125 °C		0.15	0.3	Ω

DYNAMIC

Symbol	Parameter	Test Conditions	Min.	Typ.	Max.	Unit
C _{oss}	Output Capacitance	V _{DS} = 13 V f = 1 MHz V _{in} = 0		350	500	pF

ELECTRICAL CHARACTERISTICS (continued)**SWITCHING (**)**

Symbol	Parameter	Test Conditions	Min.	Typ.	Max.	Unit
$t_{d(on)}$	Turn-on Delay Time	$V_{DD} = 16\text{ V}$ $I_d = 1\text{ A}$		1100	1600	ns
t_r	Rise Time	$V_{gen} = 7\text{ V}$ $R_{gen} = 10\ \Omega$		550	900	ns
$t_{d(off)}$	Turn-off Delay Time	(see figure 3)		200	400	ns
t_f	Fall Time			100	200	ns
$t_{d(on)}$	Turn-on Delay Time	$V_{DD} = 16\text{ V}$ $I_d = 1\text{ A}$		1.2	1.8	μs
t_r	Rise Time	$V_{gen} = 7\text{ V}$ $R_{gen} = 1000\ \Omega$		1	1.5	μs
$t_{d(off)}$	Turn-off Delay Time	(see figure 3)		1.6	2.3	μs
t_f	Fall Time			1.2	1.8	μs
$(di/dt)_{on}$	Turn-on Current Slope	$V_{DD} = 16\text{ V}$ $I_D = 1\text{ A}$ $V_{in} = 7\text{ V}$ $R_{gen} = 10\ \Omega$		1.5		A/ μs
Q_i	Total Input Charge	$V_{DD} = 12\text{ V}$ $I_D = 1\text{ A}$ $V_{in} = 7\text{ V}$		13		nC

SOURCE DRAIN DIODE

Symbol	Parameter	Test Conditions	Min.	Typ.	Max.	Unit
$V_{SD} (*)$	Forward On Voltage	$I_{SD} = 1\text{ A}$ $V_{in} = V_{IL}$		0.8	1.6	V
$t_{rr} (**)$	Reverse Recovery Time	$I_{SD} = 1\text{ A}$ $di/dt = 100\text{ A}/\mu\text{s}$ $V_{DD} = 30\text{ V}$ $T_j = 25\text{ }^\circ\text{C}$		125		ns
$Q_{rr} (**)$	Reverse Recovery Charge	(see test circuit, figure 5)		0.22		μC
$I_{RRM} (**)$	Reverse Recovery Current			3.5		A

PROTECTION

Symbol	Parameter	Test Conditions	Min.	Typ.	Max.	Unit
I_{lim}	Drain Current Limit	$V_{in} = 7\text{ V}$ $V_{DS} = 13\text{ V}$	6	10	15	A
$t_{dlim} (**)$	Step Response Current Limit	$V_{in} = 7\text{ V}$ V_{DS} step from 0 to 13 V		12	20	μs
$T_{jsh} (**)$	Overtemperature Shutdown		150			$^\circ\text{C}$
$T_{jrs} (**)$	Overtemperature Reset		135			$^\circ\text{C}$
$E_{as} (**)$	Single Pulse Avalanche Energy	starting $T_j = 25\text{ }^\circ\text{C}$ $V_{DD} = 24\text{ V}$ $V_{in} = 7\text{ V}$ $R_{gen} = 1\text{ K}\Omega$ $L = 10\text{ mH}$	250			mJ

(*) Pulsed: Pulse duration = 300 μs , duty cycle 1.5 %

(**) Parameters guaranteed by design/characterization

PROTECTION FEATURES

During Normal Operation, the INPUT pin is electrically connected to the gate of the internal power MOSFET through a low impedance path as soon as $V_{IN} > V_{IH}$.

The device then behaves like a standard power MOSFET and can be used as a switch from DC to 50KHz. The only difference from the user's standpoint is that a small DC current (typically 150 μ A) flows into the INPUT pin in order to supply the internal circuitry.

During turn-off of an unclamped inductive load the output voltage is clamped to a safe level by an integrated Zener clamp between DRAIN pin and the gate of the internal Power MOSFET.

In this condition, the Power MOSFET gate is set

to a voltage high enough to sustain the inductive load current even if the INPUT pin is driven to 0V.

The device integrates an active current limiter circuit which limits the drain current I_D to I_{lim} whatever the INPUT pin Voltage.

When the current limiter is active, the device operates in the linear region, so power dissipation may exceed the heatsinking capability. Both case and junction temperatures increase, and if this phase lasts long enough, junction temperature may reach the overtemperature threshold T_{jsh} .

If T_j reaches T_{jsh} , the device shuts down whatever the INPUT pin voltage. The device will restart automatically when T_j has cooled down to T_{jrs}

Thermal Impedance

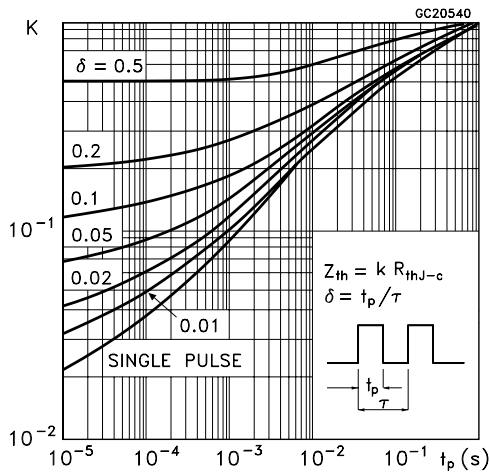

Derating Curve

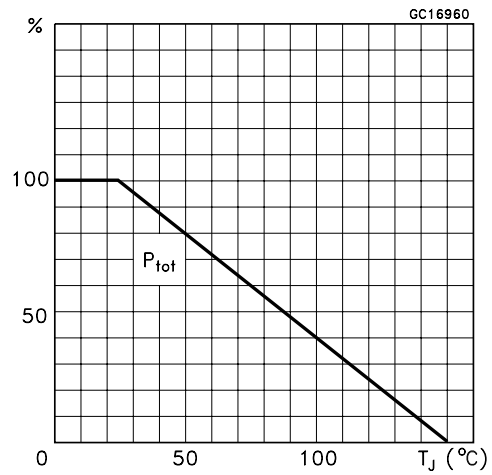

Output Characteristics

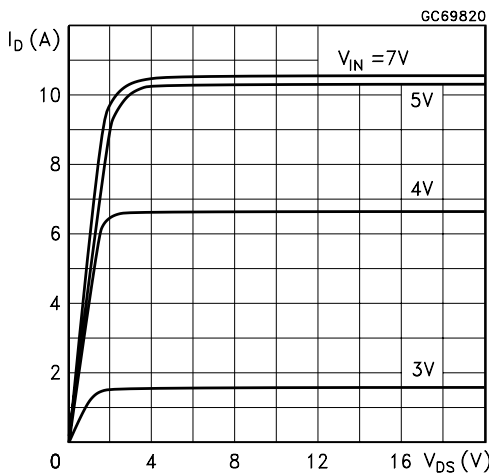

Static Drain-Source On Resistance vs Input Voltage

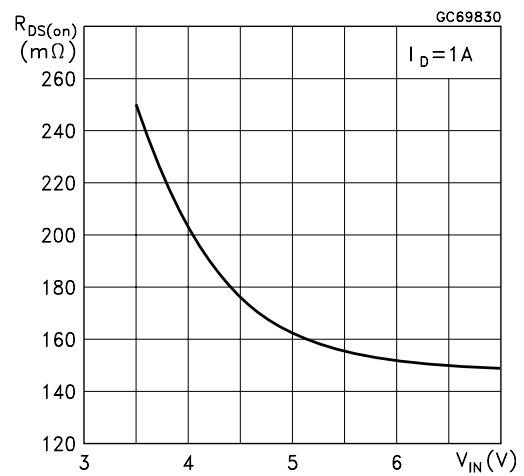

Static Drain-Source On Resistance

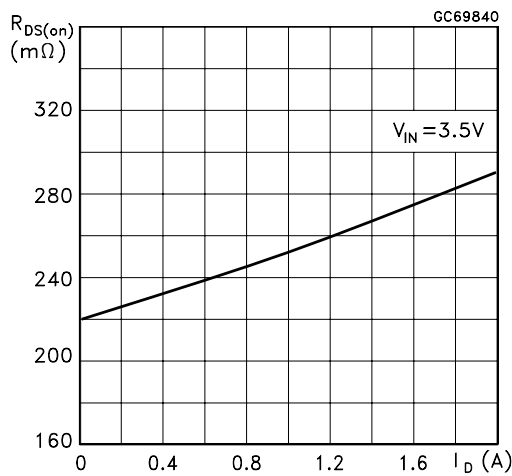

Static Drain-Source On Resistance

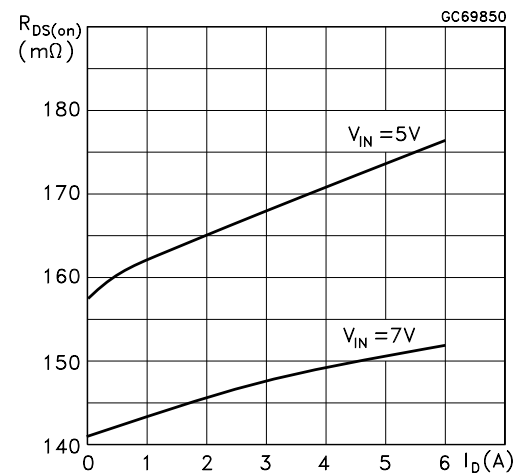

Input Charge vs Input Voltage

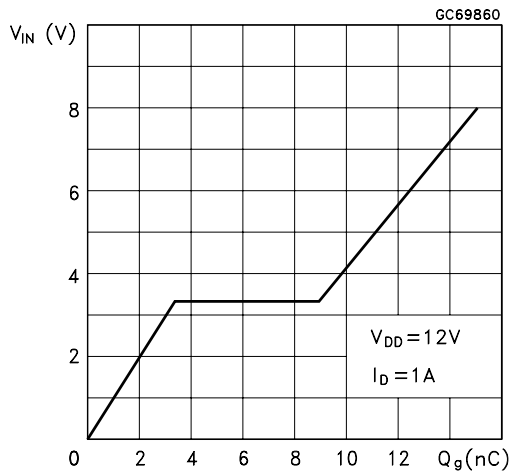

Capacitance Variations

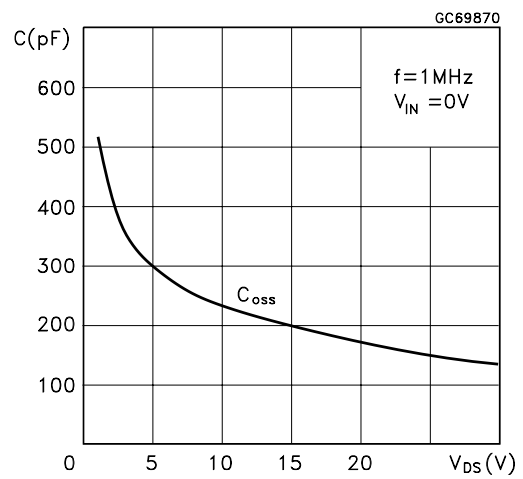

Normalized Input Threshold Voltage vs Temperature

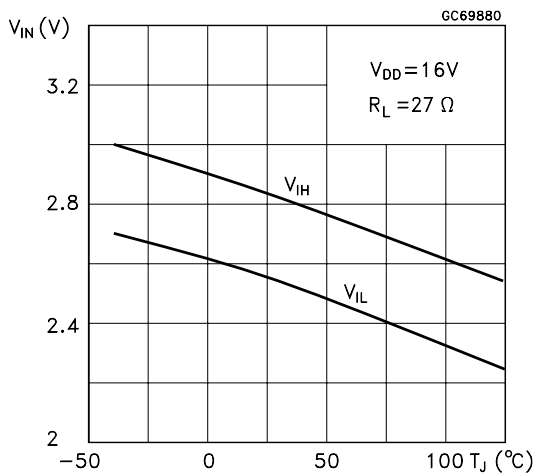

Normalized On Resistance vs Temperature

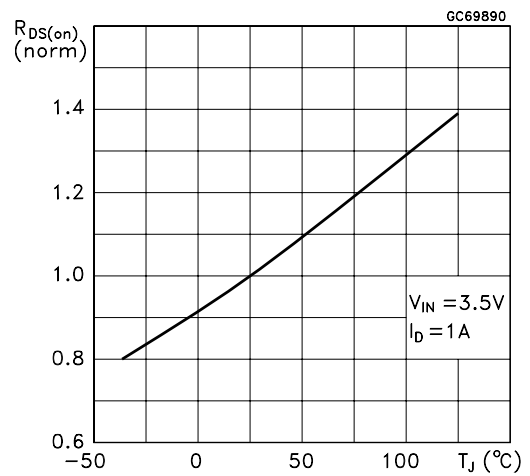

Normalized On Resistance vs Temperature

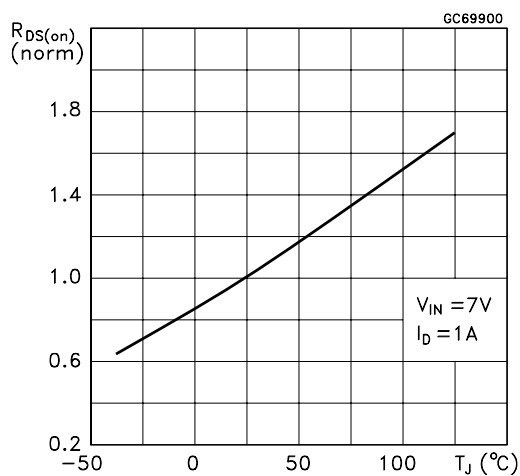

Turn-on Current Slope

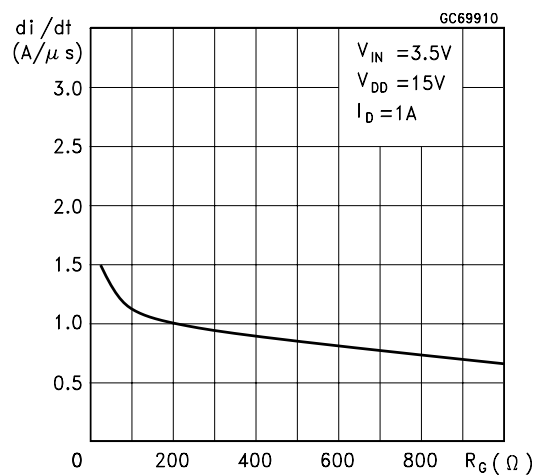

Turn-on Current Slope

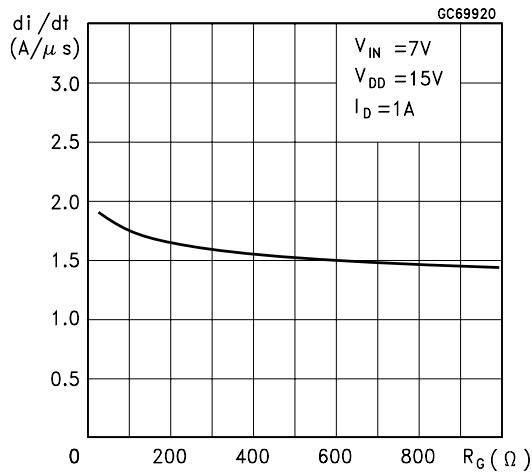

Turn-off Drain-Source Voltage Slope

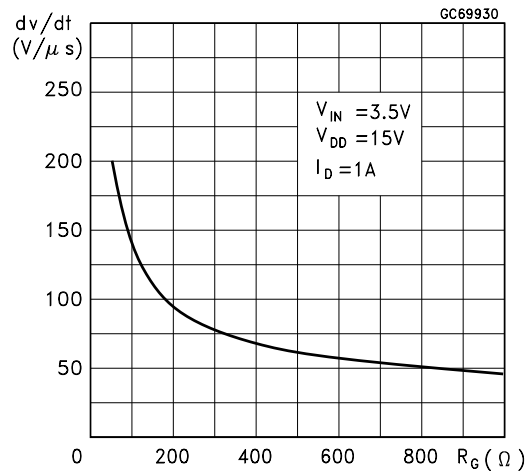

Turn-off Drain-Source Voltage Slope

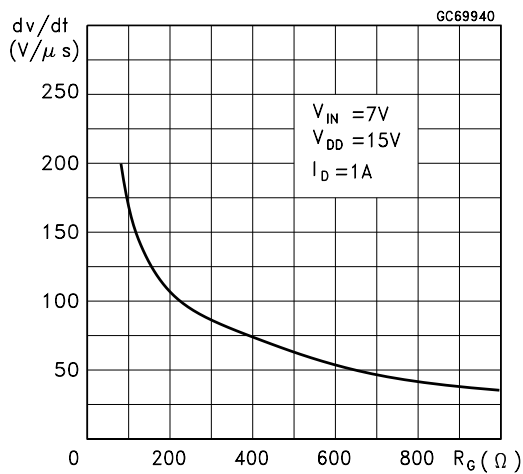

Switching Time Resistive Load

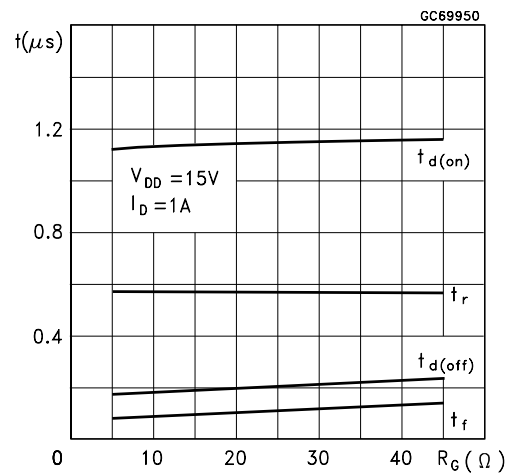

Switching Time Resistive Load

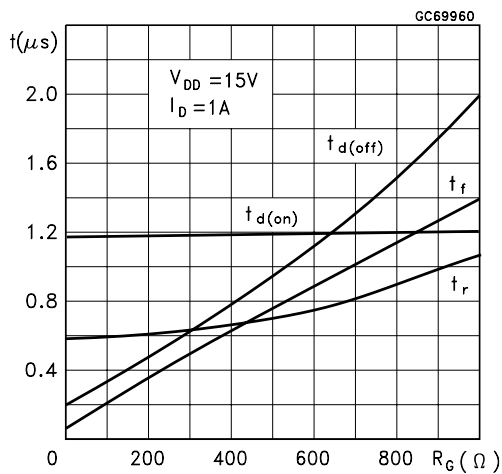

Switching Time Resistive Load

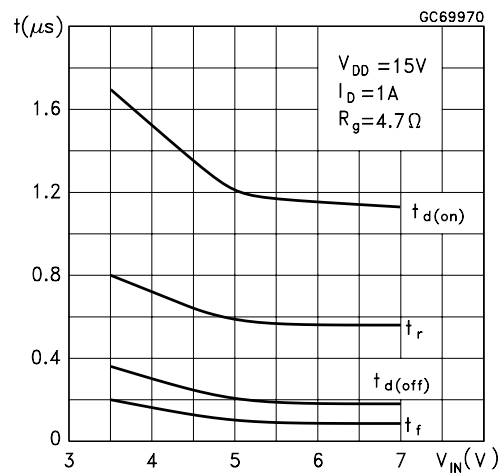

Current Limit vs Junction Temperature

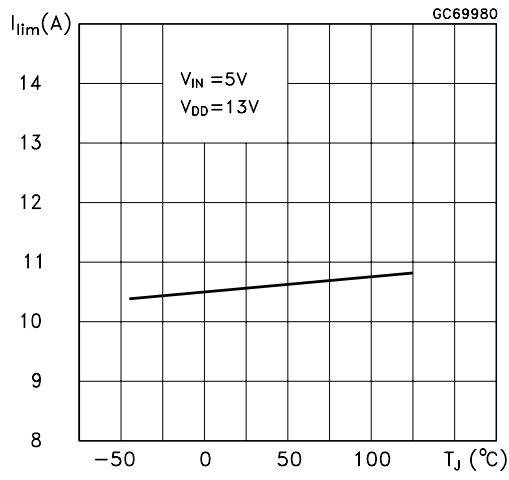

Step Response Current Limit

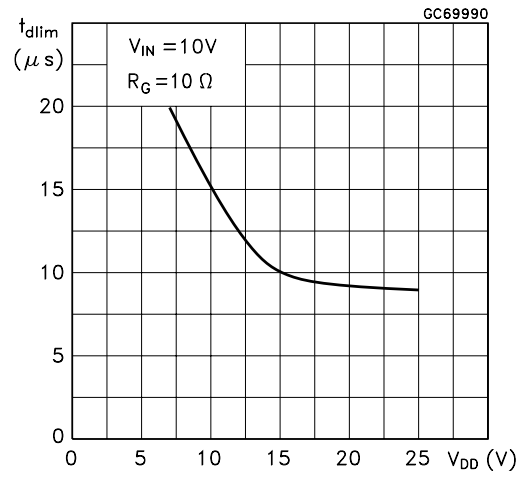

Source Drain Diode Voltage vs Junction Temperature

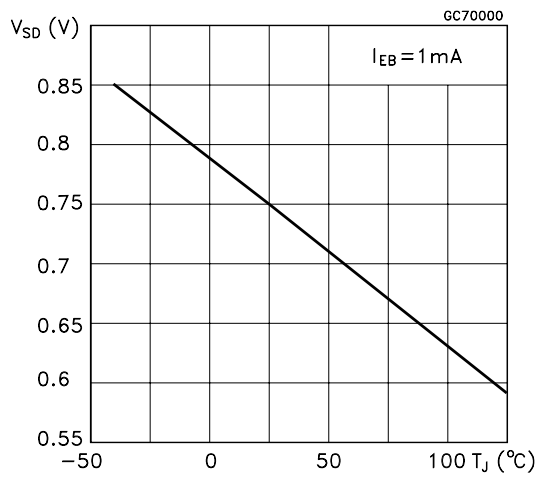

Fig. 1: Unclamped Inductive Load Test Circuits

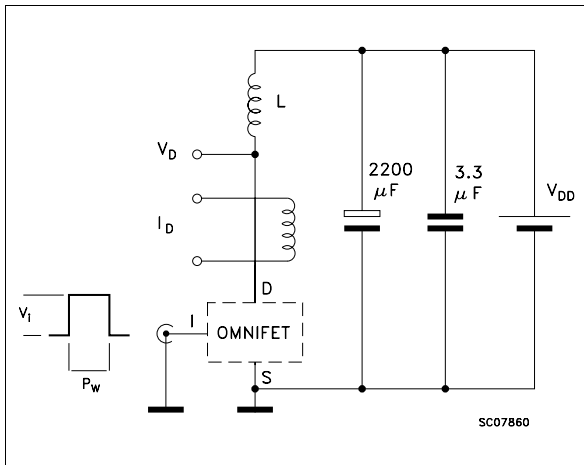

Fig. 2: Unclamped Inductive Waveforms

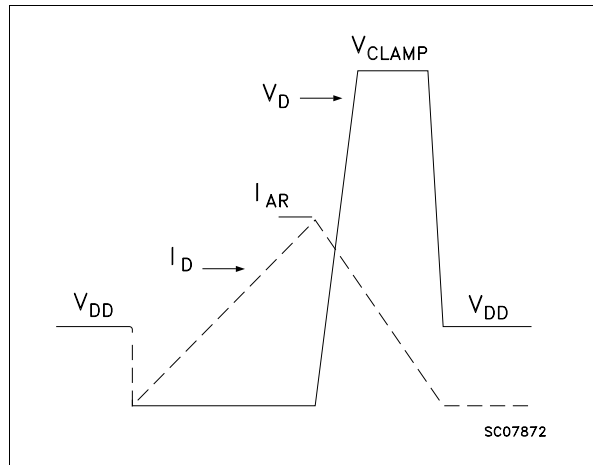

Fig. 3: Switching Times Test Circuits For Resistive Load

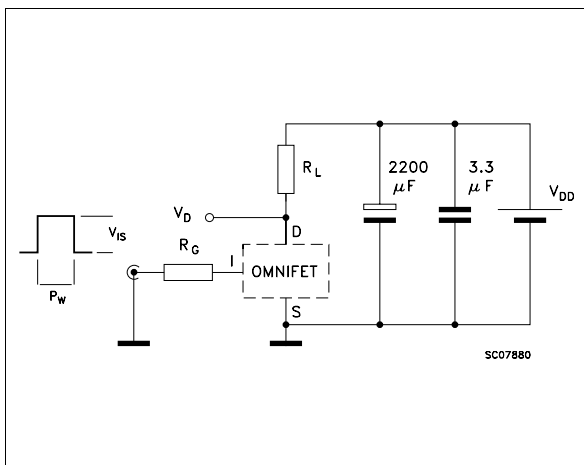

Fig. 4: Input Charge Test Circuit

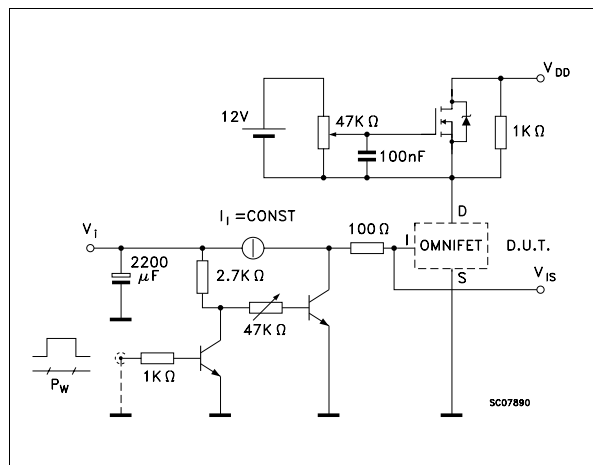

Fig. 5: Test Circuit For Inductive Load Switching And Diode Recovery Times

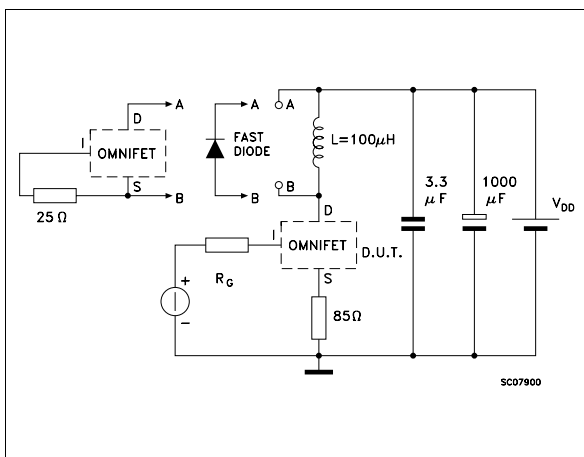
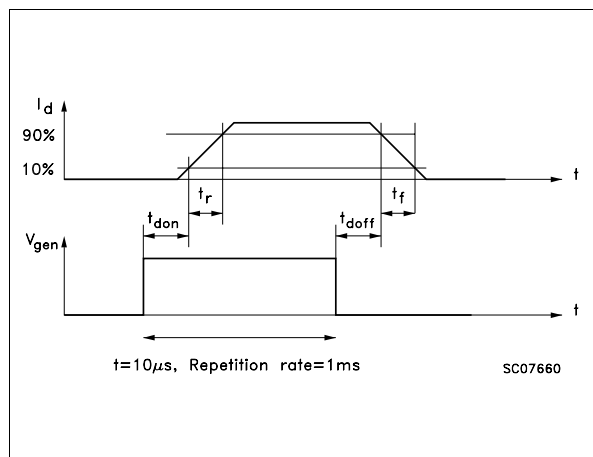

Fig. 6: Waveforms



TO-220 MECHANICAL DATA

DIM.	mm.		
	MIN.	TYP	MAX.
A	4.40		4.60
b	0.61		0.88
b1	1.15		1.70
c	0.49		0.70
D	15.25		15.75
E	10		10.40
e	2.40		2.70
e1	4.95		5.15
F	1.23		1.32
H1	6.20		6.60
J1	2.40		2.72
L	13		14
L1	3.50		3.93
L20		16.40	
L30		28.90	
ØP	3.75		3.85
Q	2.65		2.95
Package Weight	1.9Gr. (Typ.)		



Please Read Carefully:

Information in this document is provided solely in connection with ST products. STMicroelectronics NV and its subsidiaries ("ST") reserve the right to make changes, corrections, modifications or improvements, to this document, and the products and services described herein at any time, without notice.

All ST products are sold pursuant to ST's terms and conditions of sale.

Purchasers are solely responsible for the choice, selection and use of the ST products and services described herein, and ST assumes no liability whatsoever relating to the choice, selection or use of the ST products and services described herein.

No license, express or implied, by estoppel or otherwise, to any intellectual property rights is granted under this document. If any part of this document refers to any third party products or services it shall not be deemed a license grant by ST for the use of such third party products or services, or any intellectual property contained therein or considered as a warranty covering the use in any manner whatsoever of such third party products or services or any intellectual property contained therein.

UNLESS OTHERWISE SET FORTH IN ST'S TERMS AND CONDITIONS OF SALE ST DISCLAIMS ANY EXPRESS OR IMPLIED WARRANTY WITH RESPECT TO THE USE AND/OR SALE OF ST PRODUCTS INCLUDING WITHOUT LIMITATION IMPLIED WARRANTIES OF MERCHANTABILITY, FITNESS FOR A PARTICULAR PURPOSE (AND THEIR EQUIVALENTS UNDER THE LAWS OF ANY JURISDICTION), OR INFRINGEMENT OF ANY PATENT, COPYRIGHT OR OTHER INTELLECTUAL PROPERTY RIGHT.

ST PRODUCTS ARE NOT DESIGNED OR AUTHORIZED FOR USE IN: (A) SAFETY CRITICAL APPLICATIONS SUCH AS LIFE SUPPORTING, ACTIVE IMPLANTED DEVICES OR SYSTEMS WITH PRODUCT FUNCTIONAL SAFETY REQUIREMENTS; (B) AERONAUTIC APPLICATIONS; (C) AUTOMOTIVE APPLICATIONS OR ENVIRONMENTS, AND/OR (D) AEROSPACE APPLICATIONS OR ENVIRONMENTS. WHERE ST PRODUCTS ARE NOT DESIGNED FOR SUCH USE, THE PURCHASER SHALL USE PRODUCTS AT PURCHASER'S SOLE RISK, EVEN IF ST HAS BEEN INFORMED IN WRITING OF SUCH USAGE, UNLESS A PRODUCT IS EXPRESSLY DESIGNATED BY ST AS BEING INTENDED FOR "AUTOMOTIVE, AUTOMOTIVE SAFETY OR MEDICAL" INDUSTRY DOMAINS ACCORDING TO ST PRODUCT DESIGN SPECIFICATIONS. PRODUCTS FORMALLY ESCC, QML OR JAN QUALIFIED ARE DEEMED SUITABLE FOR USE IN AEROSPACE BY THE CORRESPONDING GOVERNMENTAL AGENCY.

Resale of ST products with provisions different from the statements and/or technical features set forth in this document shall immediately void any warranty granted by ST for the ST product or service described herein and shall not create or extend in any manner whatsoever, any liability of ST.

ST and the ST logo are trademarks or registered trademarks of ST in various countries.

Information in this document supersedes and replaces all information previously supplied.

The ST logo is a registered trademark of STMicroelectronics. All other names are the property of their respective owners.

© 2013 STMicroelectronics - All rights reserved

STMicroelectronics group of companies

Australia - Belgium - Brazil - Canada - China - Czech Republic - Finland - France - Germany - Hong Kong - India - Israel - Italy - Japan - Malaysia - Malta - Morocco - Philippines - Singapore - Spain - Sweden - Switzerland - United Kingdom - United States of America

www.st.com



Компания «Океан Электроники» предлагает заключение долгосрочных отношений при поставках импортных электронных компонентов на взаимовыгодных условиях!

Наши преимущества:

- Поставка оригинальных импортных электронных компонентов напрямую с производств Америки, Европы и Азии, а так же с крупнейших складов мира;
- Широкая линейка поставок активных и пассивных импортных электронных компонентов (более 30 млн. наименований);
- Поставка сложных, дефицитных, либо снятых с производства позиций;
- Оперативные сроки поставки под заказ (от 5 рабочих дней);
- Экспресс доставка в любую точку России;
- Помощь Конструкторского Отдела и консультации квалифицированных инженеров;
- Техническая поддержка проекта, помощь в подборе аналогов, поставка прототипов;
- Поставка электронных компонентов под контролем ВП;
- Система менеджмента качества сертифицирована по Международному стандарту ISO 9001;
- При необходимости вся продукция военного и аэрокосмического назначения проходит испытания и сертификацию в лаборатории (по согласованию с заказчиком);
- Поставка специализированных компонентов военного и аэрокосмического уровня качества (Xilinx, Altera, Analog Devices, Intersil, Interpoint, Microsemi, Actel, Aeroflex, Peregrine, VPT, Syfer, Eurofarad, Texas Instruments, MS Kennedy, Miteq, Cobham, E2V, MA-COM, Hittite, Mini-Circuits, General Dynamics и др.);

Компания «Океан Электроники» является официальным дистрибьютором и эксклюзивным представителем в России одного из крупнейших производителей разъемов военного и аэрокосмического назначения «JONHON», а так же официальным дистрибьютором и эксклюзивным представителем в России производителя высокотехнологичных и надежных решений для передачи СВЧ сигналов «FORSTAR».



JONHON

«JONHON» (основан в 1970 г.)

Разъемы специального, военного и аэрокосмического назначения:

(Применяются в военной, авиационной, аэрокосмической, морской, железнодорожной, горно- и нефтедобывающей отраслях промышленности)

«FORSTAR» (основан в 1998 г.)

ВЧ соединители, коаксиальные кабели, кабельные сборки и микроволновые компоненты:

(Применяются в телекоммуникациях гражданского и специального назначения, в средствах связи, РЛС, а так же военной, авиационной и аэрокосмической отраслях промышленности).



Телефон: 8 (812) 309-75-97 (многоканальный)

Факс: 8 (812) 320-03-32

Электронная почта: ocean@oceanchips.ru

Web: <http://oceanchips.ru/>

Адрес: 198099, г. Санкт-Петербург, ул. Калинина, д. 2, корп. 4, лит. А