



## PMP Series

### Proportional Control SSRs

- Single Phase Proportional Controller
- Output ratings up to 90 Amps at 600 VAC
- Selectable operation mode: Phase Angle or Burst Fire control
- Selectable Control Input: 0-5 VDC, 0-10 VDC, 4-20 mA
- 50/60 Hz Adaptive Operational Frequency function
- 4-20 mA input does not require an auxiliary power supply
- LED multifunction status indicator
- Contactor configuration with "Elevator" screw terminals
- cURus, IEC Rated, CE & RoHS Compliant

The PMP Series of micro-controller based Single-Phase Proportional Control SSRs are designed to offer precise control of the power delivered to a resistive load in a compact 22.5mm housing, with ratings from 25 up to 90 Amps at 90 to 600 VAC. PMP Series solid state relays can vary the output load power proportionally to an analog control input from 0 to 100%. This can be achieved by two different methods: Phase Angle control and Burst Fire control (with Distributive Zero Cross). The control

method to be used can be selected on the unit by means of a selector switch located on top of the SSR.

This selector switch also allows to select the type of analog signal to be used at the control input. The available input types are: 0- 5 VDC, 0-10 VDC, and 4-20 mA.

PMP Series Proportional SSRs are ideal for lamp dimming and resistive heating control, among other type of applications requiring proportional control.

## PRODUCT SELECTION

| Output Voltage | 25 A     | 50 A     | 90 A     |
|----------------|----------|----------|----------|
| 90-280 VAC     | PMP2425W | PMP2450W | PMP2490W |
| 345-530 VAC    | PMP4825W | PMP4850W | PMP4890W |
| 420-600 VAC    | PMP6025W | PMP6050W | PMP6090W |

## AVAILABLE OPTIONS

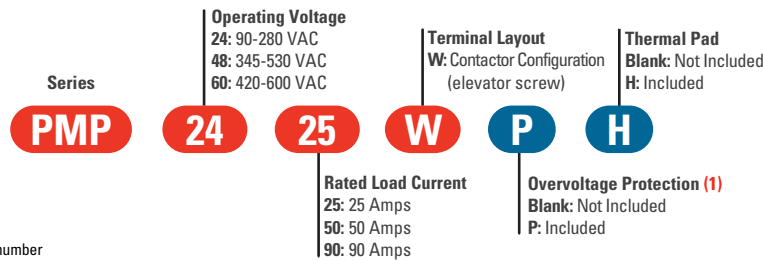

## OUTPUT VOLTAGE SPECIFICATIONS <sup>(2)</sup>

| Description  | PMP24xxW | PMP48xxW | PMP60xxW |
|--|----------|----------|----------|
| Operating Voltage (45-65Hz) [V <sub>RMS</sub> ]                        | 90-280   | 345-530  | 420-600  |
| Transient Overvoltage [V <sub>pk</sub> ] (1)                           | 600      | 1200     | 1200     |
| Maximum Off-State Leakage Current @ Rated Voltage [mA <sub>RMS</sub> ] | 4        | 2.2      | 2        |
| Minimum Off-State dV/dt @ Maximum Rated Voltage [V/μsec]               | 500      | 500      | 500      |

**OUTPUT SPECIFICATIONS <sup>(2)</sup>**

| Description  | 25 A           | 50 A           | 90 A           |
|--|----------------|----------------|----------------|
| Load Current, General Use UL508 @ 40°C [ARMS] <sup>(3)</sup>                 | 25             | 50             | 90             |
| Minimum Load Current [mARMS] <sup>(4)</sup>                                  | 100            | 100            | 150            |
| Maximum 1 Cycle Surge Current (50/60Hz) [Apk]                                | 286/300        | 716/750        | 1290/1350      |
| Maximum On-State Voltage Drop @ Rated Current [Vrms]                         | 1.15           | 1.15           | 1.2            |
| Maximum 1/2 Cycle I <sup>2</sup> t for Fusing (50/60Hz) [A <sup>2</sup> sec] | 409/375        | 2563/2343      | 8320/7593      |
| Thermal Resistance Junction to Case (Rjc) [°C/W]                             | 0.49           | 0.27           | 0.2            |
| Maximum Power Dissipation @ Rated Current [W]                                | 29             | 58             | 104            |
| Recommended Heat Sink for Rated Current @ 40°C [°C/W]                        | 2              | 1              | 0.36           |
| Minimum Power Factor (at Maximum load)                                       | 0.7            | 0.7            | 0.7            |
| Phase Angle Control Range [%]  | 0 to 100       | 0 to 100       | 0 to 100       |
| Burst Fire Distributive Control Time Base Period                             | 0 to 20 Cycles | 0 to 20 Cycles | 0 to 20 Cycles |

**POWER SUPPLY SPECIFICATIONS <sup>(2)(5)(6)</sup>**

| Description                 | PMP                          |
|-----------------------------|------------------------------|
| Supply Voltage Range [VDC]  | 8-30                         |
| Maximum Supply Current [mA] | 30                           |
| Oversvoltage Protection     | Limited to 35 VDC for 60 sec |
| Reverse Polarity Protection | Yes                          |

**INPUT SPECIFICATIONS <sup>(2)</sup>**

| Description  | Voltage Control | Current Control |
|--|-----------------|-----------------|
| Valid Input Voltage [VDC] / Current [mA]           | 0-10, 0-5       | 4-20            |
| Maximum Allowed Input Voltage [VDC] / Current [mA] | 30              | 35              |
| Maximum Reverse Voltage [VDC] / Current [mA]       | -30             | -35             |
| Pick up Voltage [VDC] / Current [mA]               | 0.4             | 4.3             |
| Dropout Voltage [VDC] / Current [mA]               | 0.1             | 4               |
| Nominal Input Impedance [Ohms]                     | 28.8k           | 230 @ 20 mA     |
| Maximum Initialization Time [msec]                 | 5 Cycles        | 5 Cycles        |
| Response Time                                      | 1 Cycle         | 1 Cycle         |

**GENERAL SPECIFICATIONS <sup>(2)</sup>**

| Description  | Parameters            |
|--|-----------------------|
| Dielectric Strength, Input to Output (50/60Hz)           | 4000 V <sub>RMS</sub> |
| Dielectric Strength, Input/Output to Baseplate (50/60Hz) | 4000 V <sub>RMS</sub> |
| Minimum Insulation Resistance (@ 500 VDC)                | 10 <sup>9</sup> Ohms  |
| Maximum Capacitance, Input/Output                        | 8 pF                  |
| Ambient Operating Temperature Range <sup>(7)</sup>       | -25 to 70 °C          |
| Ambient Storage Temperature Range <sup>(7)</sup>         | -25 to 70 °C          |
| Weight (typical)   | 2.6 oz (73 g)         |
| Housing Material   | UL94 V-0              |
| Baseplate Material                                       | Aluminum              |
| Hardware Finish  | Nickel Plating        |
| SSR Mounting Screw Torque Range (in-lb/Nm)               | 20-25/2.2-2.8         |
| Humidity per IEC 60068-2-78                              | 93% non-condensing    |
| LED Input Status Indicator                               | See Status Chart      |
| Oversvoltage Category                                    | III                   |
| Impulse Withstand Voltage According to IEC 60664-1       | 6 kV                  |
| Adaptative Operational Frequency Function                | Yes                   |

**SURGE CURRENT INFORMATION**

**PMPxx25W**

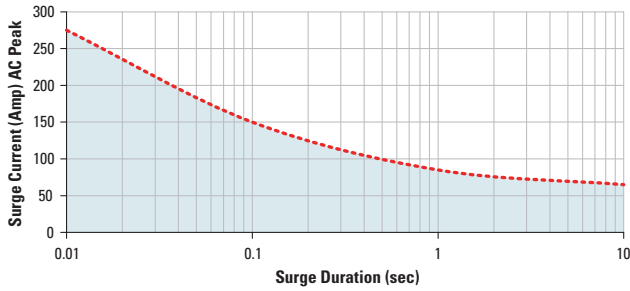

**PMPxx50W**

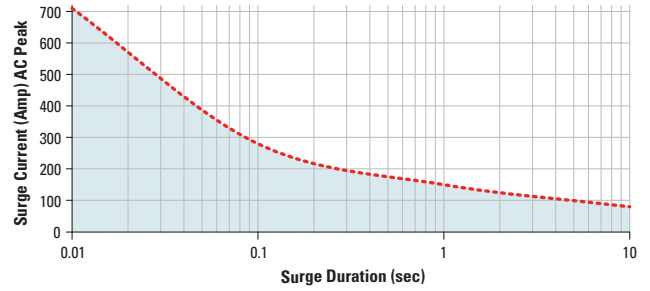

**PMPxx90W**

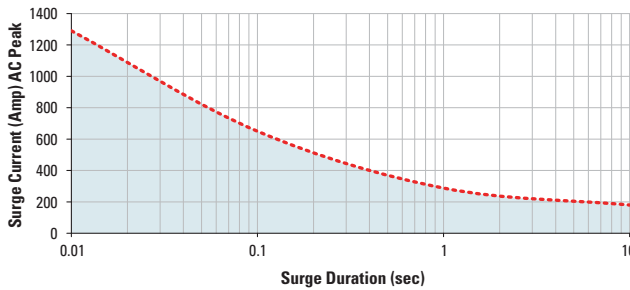

--- Single Pulse (8)

**POWER DISSIPATION**

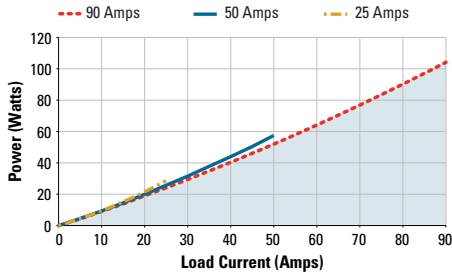

**THERMAL DERATE INFORMATION (9)**

**PMPxx25W**

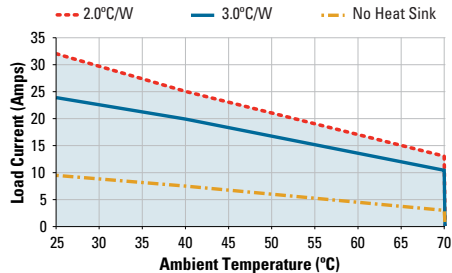

**PMPxx50W**

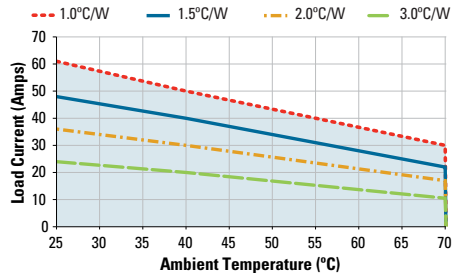

**PMPxx90W**

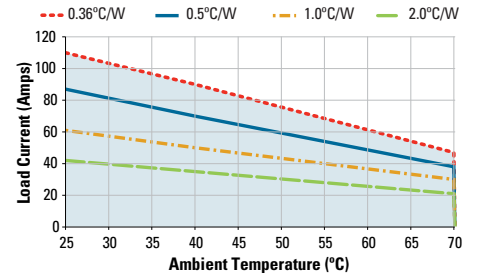

**TRANSFER CHARACTERISTICS**

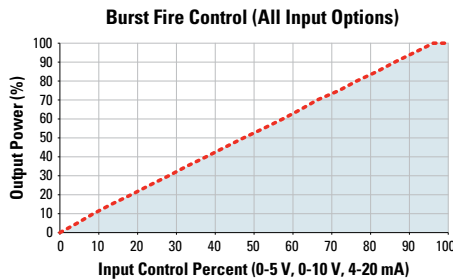
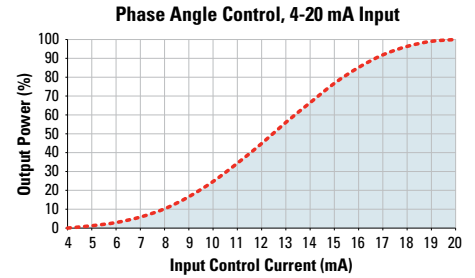
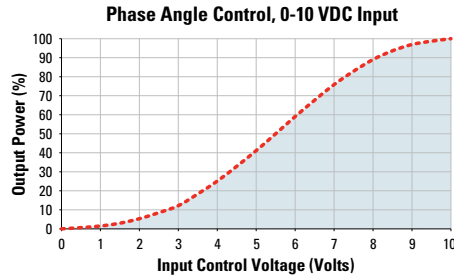
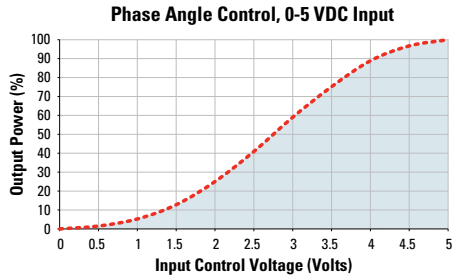

**INPUT CURRENT VS INPUT VOLTAGE**

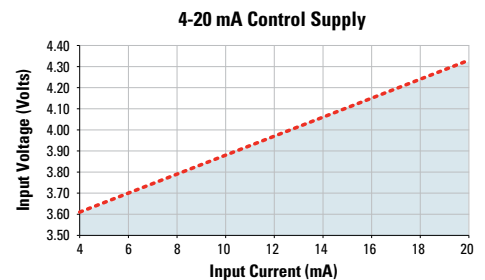
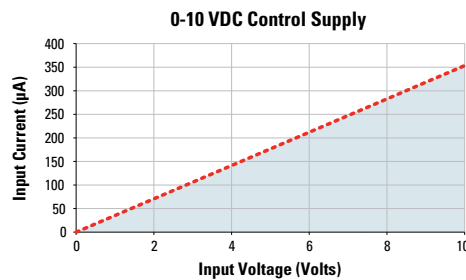
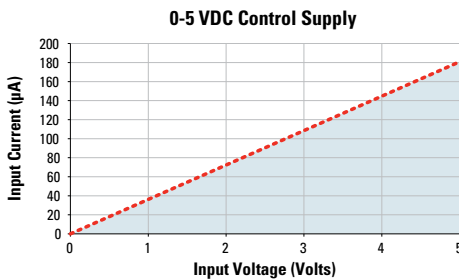

**EQUIVALENT CIRCUIT BLOCK DIAGRAM/WIRING DIAGRAM**

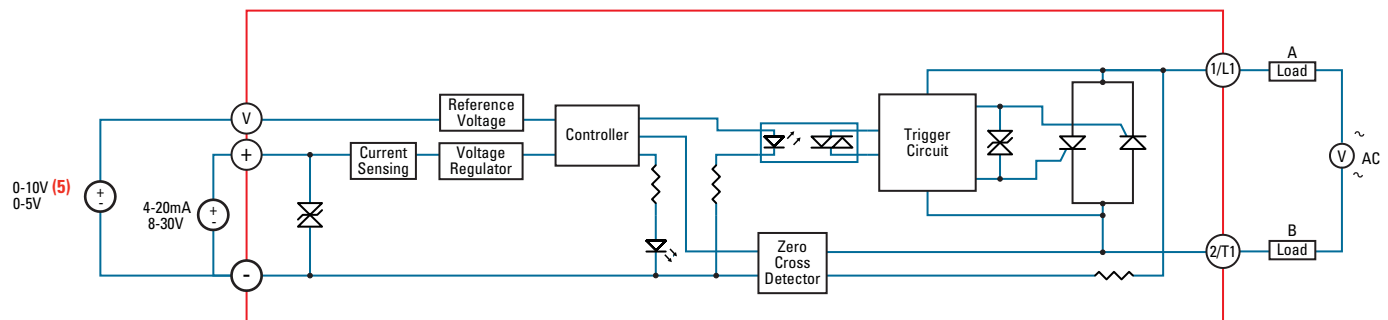

**INSTALLATION INSTRUCTIONS**

**■ Mounting on Heat Sink**

- ◆ Select adequate heat sink (see thermal derating curves).
- ◆ Be sure to use a thermal pad or thermal compound (0.006-0.008 in layer thickness recommended) SSR and the selected heat sink.
- ◆ SSR housing mounting holes have a diameter of 0.341 in (8.66mm). Two screws are needed to mount the SSR onto a heat sink (See Fig 1). Mounting screws are sold separately as HK8 and are suitable for all Crydom heat sinks. Otherwise, recommended screw size is 8-32 (socket) using an allen wrench (9/64 in) for the installation. Choose screw length considering mounting surface hole depth and SSR baseplate thickness of 0.125 in (3.2 mm).
- ◆ Before applying full torque tighten down both screws until they contact the baseplate. Then, tighten them to 20 in-lb (2.2 Nm) min.
- ◆ For optimal thermal performance heat sink fins should be oriented vertically to promote natural convection airflow.

**■ Mounting on Panel**

- ◆ Locate the panel section on which the SSR will be mounted. Panel mount surface must provide adequate heat sinking capability, uncoated, clean, flat (0.004 in/in recommended) and preferably aluminum.
- ◆ Be sure to use a thermal pad or thermal compound (0.006-0.008 in layer thickness recommended) between the SSR and the panel.
- ◆ SSR housing mounting slots have a diameter of 0.341 in (8.66 mm). Two screws are needed (not included) to mount the SSR onto a panel. Mounting screws are sold separately as HK8. Otherwise, recommended screw size is 8-32 (socket) using allen wrench (9/64 in) for the installation. Choose screw length considering the mounting surface and that the SSR baseplate thickness is 0.125 in (3.2 mm).
- ◆ Before applying full torque tighten down both screws until they contact the baseplate. Then, tighten them to 20 in-lb (2.2 Nm) min.
- Wire input and output as shown in the Wiring Diagram. For recommended wire sizes and terminal torques see TABLE 1
- Select operation mode using the parameter selector switch See TABLE 2

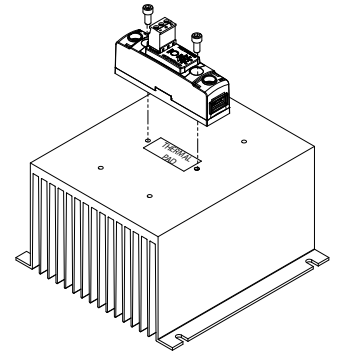

**TABLE 1. Recommended Torque and Wire Sizes**

| Terminal | Max. Screw Torque [in-lb (Nm)] | Wire Size (Solid / Stranded)                 | Wire Pull-Out Strength (lb)[N] |
|----------|--------------------------------|--|--------------------------------|
| Output   | 18-20 (2.0-2.2)                | 2 x 20 AWG (0.75 mm <sup>2</sup> ) [minimum] | 25 [111]                       |
|          |                                | 2 x 10 AWG (6 mm <sup>2</sup> )              | 80 [355]                       |
|          |                                | 2 x 8 AWG (10 mm <sup>2</sup> ) [maximum]    | 90 [400]                       |
| Input    | 5 (0.5)                        | 28 AWG (0.09 mm <sup>2</sup> ) [minimum]     | 2.2 [9.8]                      |
|          |                                | 12 AWG (3.3 mm <sup>2</sup> ) [maximum]      | 22 [98]                        |

**TABLE 2. Operation Mode**

| Parameter Selector Switch | Mode | Function                      |
|---------------------------|------|-------------------------------|
|                           | A    | Phase Angle, 0-5 VDC control  |
|                           | B    | Phase Angle, 0-10 VDC control |
|                           | C    | Phase Angle, 4-20 mA control  |
|                           | D    | Burst Fire, 0-5 VDC control   |
|                           | E    | Burst Fire, 0-10 VDC control  |
|                           | F    | Burst Fire, 4-20 mA control   |

**STATUS CHARTS**

**TABLE 3. LED Status**

| Status                 | LED Indicator                      | SSR Output |
|------------------------|------------------------------------|------------|
| No Mains Voltage (10)  | Flashes twice intermittently       | OFF        |
| Frequency Out of Range | Flashes three times intermittently | OFF        |
| Error on Selector      | Flashes four times intermittently  | OFF        |
| Overtemperature (11)   | Flashes five times intermittently  | OFF        |
| Phase Control          | Varying brightness                 | ON         |
| Burst Control          | Varying pulsing rate               | ON         |

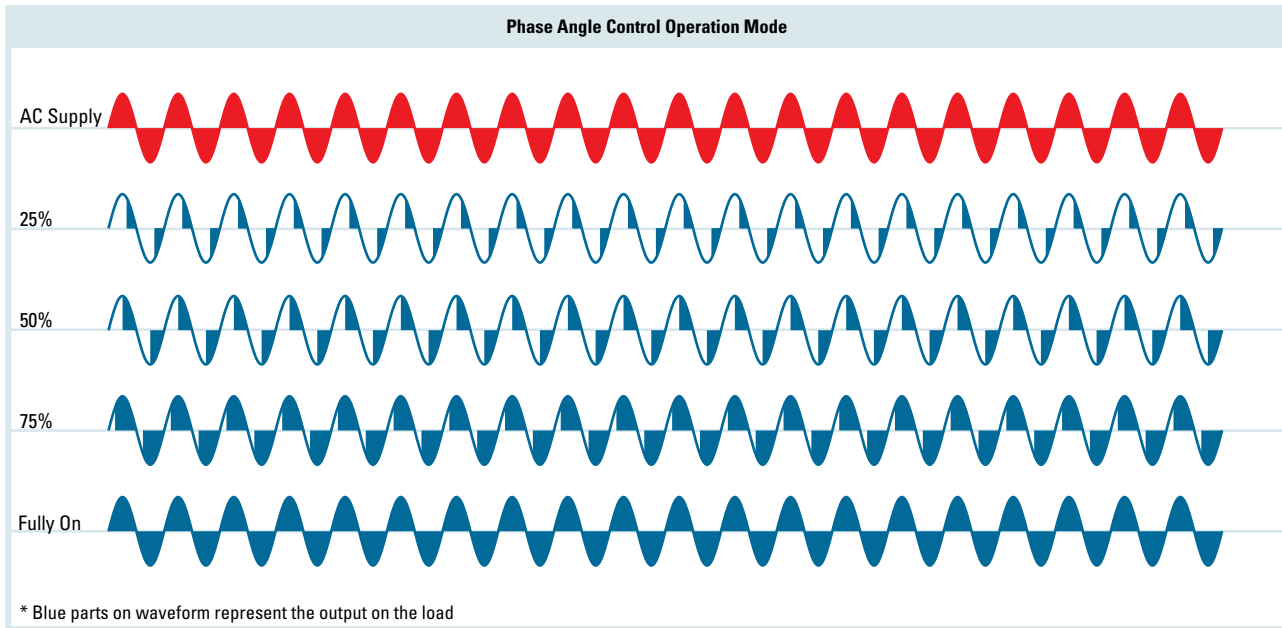
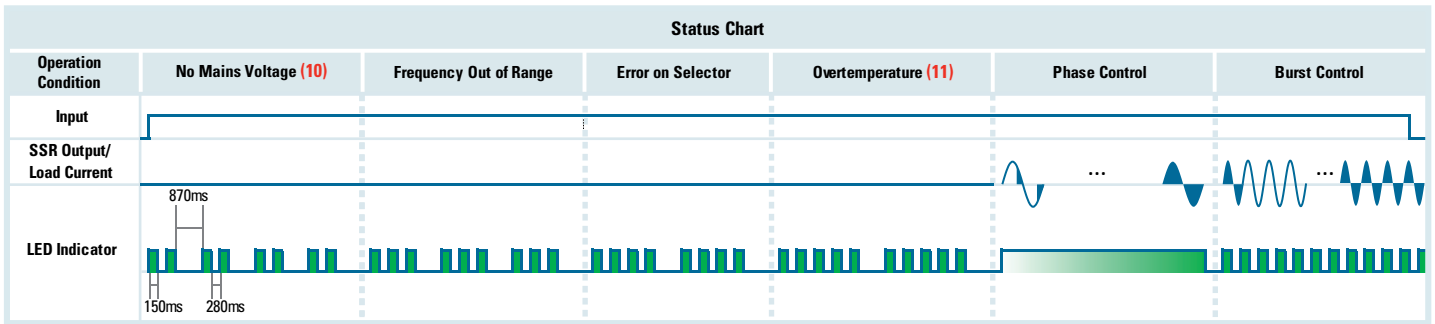

**Burst Fire Control Operation Mode**

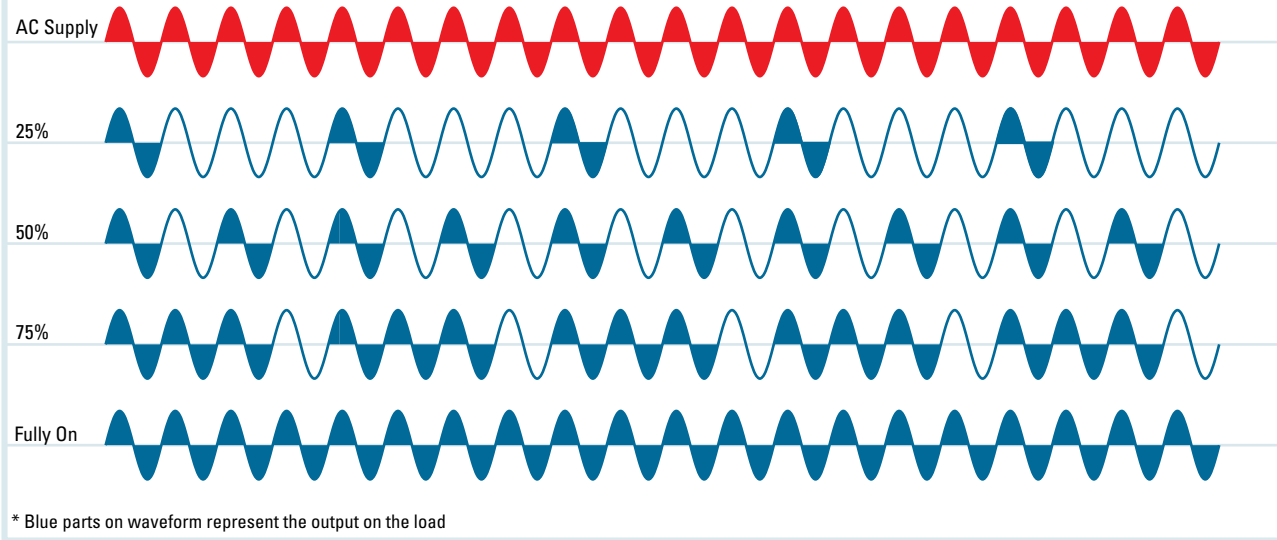

**MECHANICAL SPECIFICATIONS**

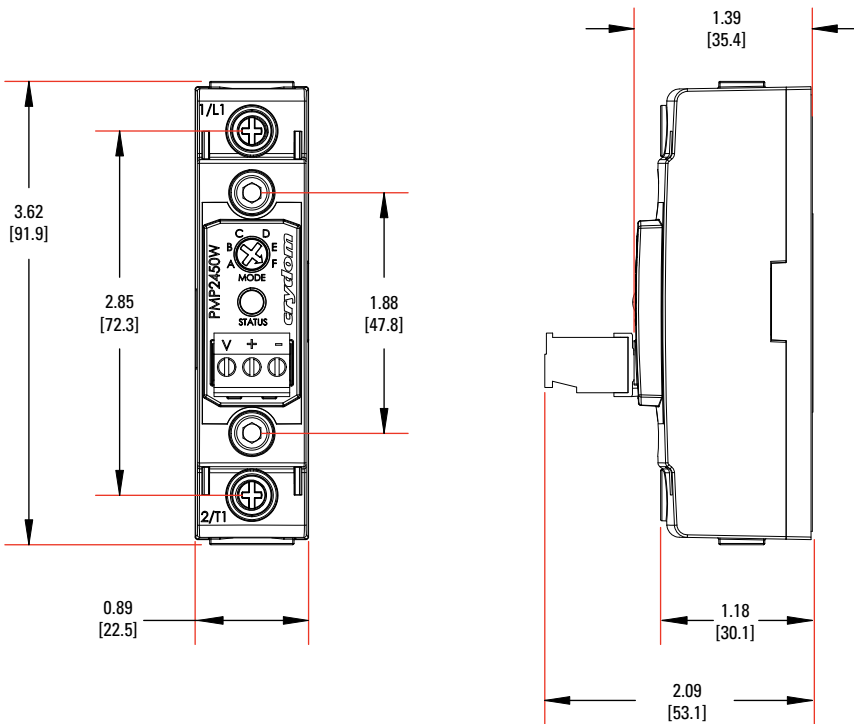

Tolerances:  $\pm 0.02$  in / 0.5 mm  
All dimensions are in: inches [millimeters]

**ACCESSORIES**

| Recommended Accessories |                    |                           |             |              |
|-------------------------|--------------------|---------------------------|-------------|--------------|
| Hardware Kit            | Heat Sink Part No. | Thermal Resistance [°C/W] | Thermal Pad | Lug Terminal |
| HK8                     | HS259DR            | 2.5                       | HSP-7       | TRM0         |
|                         | HS073              | 0.7                       |             | TRM6         |
|                         | HS072              | 0.7                       |             |              |
|                         | HS053              | 0.5                       |             |              |
|                         | HS033              | 0.36                      |             |              |
|                         | HS023              | 0.25                      |             |              |

**AGENCY APPROVALS, CONFORMANCES AND EMC**

| Approvals   |
|---|
|      |

| Conformances  |
|---|
| United States Standard for Industrial Control Equipment - UL 508 and Canadian Standard Association for Industrial Control Equipment – C22.2 No. 14. |
| Vibration Resistance IEC 60068-2-6: Amplitude Range 10-55 Hz, Displacement 0.75 mm  |
| Shock Resistance IEC 60068-2-27: Peak Acceleration 15g, Duration 11ms.  |

| Electromagnetic Compatibility                         |  |                          |                   |             |
|---|--|--------------------------|-------------------|-------------|
| Generic Standard                                      | Immunity Tests                           | Test Specification Level | Performance       |             |
| IEC 61000-6-2<br>Immunity for Industrial Environments | Electrostatic Discharge<br>IEC 61000-4-2 | 8kV air discharge        | Criterion A       |             |
|   |  | 6kV contact discharge    | Criterion A       |             |
|   | Fast transients (burst)<br>IEC 61000-4-4 | Output                   | 2kV, 5kHz, 100kHz | Criterion B |
|   |  | Input                    | 1kV, 5kHz, 100kHz | Criterion B |
|   | Surge<br>IEC 61000-4-5                   | Output                   | 1kV Line to Line  | Criterion B |
|   |  |                          | 2kV Line to Earth | Criterion B |
|   |  | Input Power Supply       | 500 VDC +/-       | Criterion A |

**GENERAL NOTES**

- (1) "P" option output will self-trigger between 450-600Vpk (for Operating Voltage option 24) or 900-1200Vpk (for Operating Voltage options 48 and 60). Not suitable for capacitive loads.
- (2) All parameters at 25°C unless otherwise specified.
- (3) Heat sinking required, see derating curves. For load currents greater than 50A use conductors with at least 75°C insulation.
- (4) If load current is lower than SSR minimum current, connect resistor in parallel to the load to increase current.
- (5) Not required for Current control.
- (6) Input should be supplied by Class 2 or double insulated power supply.
- (7) No freezing or condensation allowed.
- (8) For single surge pulse Tc=25°C; Tj=125°C. For AC Output SSRs, AC RMS value of surge current equals the peak value divided by  $\sqrt{2}$  (1.414).
- (9) UL approved rating is the one that intersects at 40°C.
- (10) This function is disabled when control signal is set at 100%.
- (11) This condition can be caused by excessive ambient temperature, an incorrect heat sink or high input voltage. The condition will be cleared once the internal temperature cools down below 80 °C.



**⚠ DANGER / PELIGRO / DANGER /GEFAHR / PERICOLO / 危險**

|  |  |   |   |  |   |
|--|--|---|---|--|---|
| <p><b>HAZARD OF ELECTRIC SHOCK, EXPLOSION, OR ARC FLASH.</b></p> <ul style="list-style-type: none"> <li>• Disconnect all power before installing or working with this equipment.</li> <li>• Verify all connections and replace all covers before turning on power.</li> </ul> <p><b>Failure to follow these instructions will result in death or serious injury.</b></p> | <p><b>RIESGO DE DESCARGA ELECTRICA O EXPLOSION.</b></p> <ul style="list-style-type: none"> <li>• Desconectar todos los suministros de energia a este equipo antes de trabajar con este equipo.</li> <li>• Verificar todas las conexiones y colocar todas las tapas antes de energizar el equipo.</li> </ul> <p><b>El incumplimiento de estas instrucciones puede provocar la muerte o lesiones serias.</b></p> | <p><b>RISQUE DE DESCARGE ELECTRIQUE OU EXPLOSION</b></p> <ul style="list-style-type: none"> <li>• Eteindre toutes les sources d'énergie de cet appareil avant de travailler dessus de cet appareil</li> <li>• Vérifier tous connections, et remettre tous couverts en place avant de mettre sous</li> </ul> <p><b>De non-suivi de ces instructions provoquera la mort ou des lésions sérieuses.</b></p> | <p><b>GEFAHR EINES ELEKTRISCHEN SCHLAGES ODER EINER EXPLOSION.</b></p> <ul style="list-style-type: none"> <li>• Stellen Sie jeglichen Strom ab, der dieses Gerät versorgt, bevor Sie an dem Gerät Arbeiten durchführen</li> <li>• Vor dem Drehen auf Energie alle Anschlüsse überprüfen und alle Abdeckungen ersetzen.</li> </ul> <p><b>Unterlassung dieser Anweisungen können zum Tode oder zu schweren Verletzungen führen.</b></p> | <p><b>RISCHIO DI SCOSSA ELETTRICA O DELL'ESPLOSIONE.</b></p> <ul style="list-style-type: none"> <li>• Spenga tutta l'alimentazione che fornisce questa apparecchiatura prima di lavorare a questa apparecchiatura</li> <li>• Verificare tutti i collegamenti e sostituire tutte le coperture prima dell'accensione</li> </ul> <p><b>L'omissione di queste istruzioni provocherà la morte o lesioni serie</b></p> | <p><b>存在电击、爆炸或电弧闪烁危险</b></p> <ul style="list-style-type: none"> <li>• 在操作此设备之前请先关闭电源。</li> </ul> <p><b>若不遵守这些说明,可能会导致严重的人身伤害甚至死亡。</b></p> |
|--|--|---|---|--|---|

**⚠ WARNING / AVERTISSEMENT / WARNUNG /ADVERTENCIA / AVVERTENZA / 警告**

|  |  |  |
|--|--|--|
| <p><b>RISK OF MATERIAL DAMAGE AND HOT ENCLOSURE</b></p> <ul style="list-style-type: none"> <li>• The product's side panels may be hot, allow the product to cool before touching.</li> <li>• Follow proper mounting instructions including torque values.</li> <li>• Do not allow liquids or foreign objects to enter this product.</li> </ul> <p><b>Failure to follow these instructions can result in serious injury, or equipment damage.</b></p>   | <p><b>RISQUE DE DOMMAGE MATERIEL ET DE SURCHAUFFE DU BOITIER</b></p> <ul style="list-style-type: none"> <li>• Les panneaux latéraux du produit peuvent être chauds. Laisser le produit refroidir avant de le toucher.</li> <li>• Respecter les consignes de montage, et notamment les couples de serrage.</li> <li>• Ne pas laisser pénétrer de liquide ni de corps étrangers à l'intérieur du produit.</li> </ul> <p><b>Le non-respect de cette directive peut entraîner, des lésions corporelles graves ou des dommages matériels.</b></p> | <p><b>GEFAHR VON MATERIALSCHÄDEN UND GEHÄUSEERHITZUNG</b></p> <ul style="list-style-type: none"> <li>• Die Seitenwände können heiß sein. Lassen Sie das Produkt abkühlen, bevor Sie es berühren.</li> <li>• Beachten Sie die Montageanweisungen,</li> <li>• Führen Sie keine Flüssigkeiten oder Fremdkörper in das Produkt ein.</li> </ul> <p><b>Die Nichtbeachtung dieser Anweisung kann Körperverletzung oder Materialschäden zur Folge haben.</b></p> |
| <p><b>RIESGO DE DAÑOS MATERIALES Y DE SOBRECALENTAMIENTO DE LA UNIDAD</b></p> <ul style="list-style-type: none"> <li>• Los paneles laterales del producto pueden estar calientes. Esperar que el producto se enfríe antes de tocarlo.</li> <li>• Respetar las instrucciones de montaje, y en particular los pares de apretado.</li> <li>• No dejar que penetren líquidos o cuerpos extraños en el producto.</li> </ul> <p><b>Si no se respetan estas precauciones pueden producirse graves lesiones, daños materiales.</b></p> | <p><b>RISCHIO DI DANNI MATERIALI E D'INVOLUCRO CALDO</b></p> <ul style="list-style-type: none"> <li>• I pannelli laterali dell'apparecchio possono scottare; lasciar quindi raffreddare il prodotto prima di toccarlo.</li> <li>• Seguire le istruzioni di montaggio corrette.</li> <li>• Non far entrare liquidi o oggetti estranei in questo apparecchio.</li> </ul> <p><b>La mancata osservanza di questa precauzione può causare gravi rischi per l'incolumità personale o danni alle apparecchiature.</b></p>                           | <p><b>材料损坏和高温外壳的危险性</b></p> <ul style="list-style-type: none"> <li>• 产品的一侧面板可能很热, 在其冷却前请不要触碰。</li> <li>• 遵照正确的安装说明, 包括扭矩值。</li> <li>• 请勿让液体及其他异物进入本产品。</li> </ul> <p><b>如不能正确执行这些操作说明, 极有可能造成严重人体伤害或者设备的损坏。</b></p>  |

**ANNEX - ENVIROMENTAL INFORMATION**

The environmental information disclosed in this annex including the EIP Pollution logo are in compliance with People’s Republic of China Electronic Industry Standard SJ/T11364 – 2006, Marking for Control of Pollution Caused by Electronic Information Products.

| Part Name         | Toxic or hazardous Substance and Elements |              |              |                               |                                |                                       |
|-------------------|---|--------------|--------------|-------------------------------|--------------------------------|---------------------------------------|
|                   | Lead (Pb)                                 | Mercury (Hg) | Cadmium (Cd) | Hexavalent Chromium (Cr (VI)) | Polybrominated biphenyls (PBB) | Polybrominated diphenyl ethers (PBDE) |
| Semiconductor die | X   | O            | O            | O                             | O                              | O                                     |
| Solder            | X   | O            | O            | O                             | O                              | O                                     |

附件 – 环保信息

此附件所标示的包括电子信息产品污染图标的环保信息符合中华人民共和国电子行业标准 SJ/T11364 - 2006, 电子信息产品污染控制标识要求。

| 部件名称  | 有毒有害物质或元素 |        |        |               |            |              |
|-------|-----------|--------|--------|---------------|------------|--------------|
|       | 铅 (Pb)    | 汞 (Hg) | 镉 (Cd) | 六价铬 (Cr (VI)) | 多溴联苯 (PBB) | 多溴二苯醚 (PBDE) |
| 半导体芯片 | X         | O      | O      | O             | O          | O            |
| 焊接点   | X         | O      | O      | O             | O          | O            |



Компания «Океан Электроники» предлагает заключение долгосрочных отношений при поставках импортных электронных компонентов на взаимовыгодных условиях!

Наши преимущества:

- Поставка оригинальных импортных электронных компонентов напрямую с производств Америки, Европы и Азии, а так же с крупнейших складов мира;
- Широкая линейка поставок активных и пассивных импортных электронных компонентов (более 30 млн. наименований);
- Поставка сложных, дефицитных, либо снятых с производства позиций;
- Оперативные сроки поставки под заказ (от 5 рабочих дней);
- Экспресс доставка в любую точку России;
- Помощь Конструкторского Отдела и консультации квалифицированных инженеров;
- Техническая поддержка проекта, помощь в подборе аналогов, поставка прототипов;
- Поставка электронных компонентов под контролем ВП;
- Система менеджмента качества сертифицирована по Международному стандарту ISO 9001;
- При необходимости вся продукция военного и аэрокосмического назначения проходит испытания и сертификацию в лаборатории (по согласованию с заказчиком);
- Поставка специализированных компонентов военного и аэрокосмического уровня качества (Xilinx, Altera, Analog Devices, Intersil, Interpoint, Microsemi, Actel, Aeroflex, Peregrine, VPT, Syfer, Eurofarad, Texas Instruments, MS Kennedy, Miteq, Cobham, E2V, MA-COM, Hittite, Mini-Circuits, General Dynamics и др.);

Компания «Океан Электроники» является официальным дистрибьютором и эксклюзивным представителем в России одного из крупнейших производителей разъемов военного и аэрокосмического назначения «JONHON», а так же официальным дистрибьютором и эксклюзивным представителем в России производителя высокотехнологичных и надежных решений для передачи СВЧ сигналов «FORSTAR».



## JONHON

«JONHON» (основан в 1970 г.)

Разъемы специального, военного и аэрокосмического назначения:

(Применяются в военной, авиационной, аэрокосмической, морской, железнодорожной, горно- и нефтедобывающей отраслях промышленности)

«FORSTAR» (основан в 1998 г.)

ВЧ соединители, коаксиальные кабели, кабельные сборки и микроволновые компоненты:

(Применяются в телекоммуникациях гражданского и специального назначения, в средствах связи, РЛС, а так же военной, авиационной и аэрокосмической отраслях промышленности).



Телефон: 8 (812) 309-75-97 (многоканальный)

Факс: 8 (812) 320-03-32

Электронная почта: [ocean@oceanchips.ru](mailto:ocean@oceanchips.ru)

Web: <http://oceanchips.ru/>

Адрес: 198099, г. Санкт-Петербург, ул. Калинина, д. 2, корп. 4, лит. А