

APPROVAL SHEET

MULTILAYER CERAMIC CAPACITORS

Microwave Series (RF)

01005 to 1111 Sizes (6.3V to 1500V)

NP0 Dielectric

Halogen Free & RoHS Compliance



*Contents in this sheet are subject to change without prior notice.

Multilayer Ceramic Capacitors

1. INTRODUCTION

MLCC consists of a conducting material and electrodes. To manufacture a chip-type SMT and achieve miniaturization, high density and high efficiency, ceramic condensers are used.

WTC RF series MLCC is used at high frequencies generally have a small temperature coefficient of capacitance, typical within the $\pm 30\text{ppm}/^\circ\text{C}$ required for NP0 (C0G) classification and have excellent conductivity internal electrode. Thus, WTC RF series MLCC will be with the feature of low ESR and high Q characteristics.

2. FEATURES

- a. High Q and low ESR performance at high frequency.
- b. Ultra low capacitance to 0.1pF.
- c. Can offer high precision tolerance to $\pm 0.05\text{pF}$.
- d. Quality improvement of telephone calls for low power loss and better performance.

3. APPLICATIONS

- a. Telecommunication products & equipments: Mobile phone, WLAN, Base station.
- b. RF module: Power amplifier, VCO.
- c. Tuners.

4. HOW TO ORDER

<u>RF</u>	<u>15</u>	<u>N</u>	<u>100</u>	<u>J</u>	<u>500</u>	<u>C</u>	<u>I</u>
<u>Series</u>	<u>Size</u>	<u>Dielectric</u>	<u>Capacitance</u>	<u>Tolerance</u>	<u>Rated voltage</u>	<u>Termination</u>	<u>Packaging</u>
RF=Ultra High Q & Low ESR	02=01005(0402) 03=0201 (0603) 15=0402 (1005) 18=0603 (1608) 11=0505 (1414) 21=0805 (2012) 22=1111 (2828)	N=NP0	Two significant digits followed by no. of zeros. And R is in place of decimal point. eg.: 0R5=0.5pF 1R0=1.0pF 100=10x10 ⁰ =10pF	A= $\pm 0.05\text{pF}$ B= $\pm 0.1\text{pF}$ C= $\pm 0.25\text{pF}$ D= $\pm 0.5\text{pF}$ F= $\pm 1\%$ G= $\pm 2\%$ J= $\pm 5\%$	Two significant digits followed by no. of zeros. And R is in place of decimal point. 6R3=6.3 VDC 100=10 VDC 250=25 VDC 500=50 VDC 101=100 VDC 201=200 VDC 251=250 VDC 501=500 VDC 152=1500 VDC	C=Cu/Ni/Sn	T=7" reeled G= 13" reeled

Multilayer Ceramic Capacitors

5. EXTERNAL DIMENSIONS

Size Inch (mm)	L (mm)	W (mm)	T (mm)/Symbol	Remark	M _B (mm)
01005 (0402)	0.40±0.02	0.20±0.02	0.20±0.02	V #	0.10±0.03
0201 (0603)	0.60±0.03	0.30±0.03	0.30±0.03	L #	0.15±0.05
0402 (1005)	1.00±0.05	0.50±0.05	0.50±0.05	N #	0.25±0.05/-0.10
0603 (1608)	1.60±0.10	0.80±0.10	0.80±0.07	S	0.40±0.15
	1.60 +0.15/-0.10	0.80 +0.15/-0.10	0.50±0.10	H	
0805 (2012)	2.00±0.15	1.25±0.10	0.60±0.10	A	0.50±0.20
	2.00±0.20	1.25±0.20	0.85±0.10	T	
0505 (1414)	1.40 +0.38/-0.25	1.40±0.38	1.15±0.15	J #	0.25±0.25/-0.13
1111 (2828)	2.79 +0.51/-0.25	2.79±0.38	≤ 1.78	G #	0.38±0.25



Reflow soldering only is recommended.

6. GENERAL ELECTRICAL DATA

Dielectric	NP0
Size	01005, 0201, 0402, 0505, 0603, 0805, 1111
Capacitance*	0.1pF to 1000pF
Capacitance tolerance	Cap≤5pF: A (±0.05pF), B (±0.1pF), C (±0.25pF) 5pF<Cap<10pF: B (±0.1pF), C (±0.25pF), D (±0.5pF) Cap≥10pF: F (±1%), G (±2%), J (±5%)
Rated voltage (WVDC)	6.3V, 10V, 25V, 50V, 100V, 200V, 250V, 500V, 1500V
Q*	01005, 0201, 0402/25V~50V: Cap<30pF:Q≥400+20C; Cap≥30pF:Q≥1000 0402/100V~200V, 0603, 0805, 0505, 1111: Cap<30pF:Q≥800+20C; Cap≥30pF:Q≥1400
Insulation resistance at U_r	≥10GΩ or R _x C≥100Ω·F whichever is smaller.
Operating temperature	-55 to +125°C
Capacitance change	±30ppm/°C
Termination	Ni/Sn (lead-free termination)

* Measured at the conditions of 25°C ambient temperature and 30~70% related humidity.

Apply 1.0±0.2Vrms, 1.0MHz±10% for Cap≤1000pF and 1.0±0.2Vrms, 1.0kHz±10% for Cap>1000pF.

7. PACKAGING DIMENSION AND QUANTITY

Size	Thickness (mm)/Symbol		Paper tape	
			7" reel	13" reel
01005 (0402)	0.20±0.02	V	20,000	-
0201 (0603)	0.30±0.03	L	15,000	70,000
0402 (1005)	0.50±0.05	N	10,000	50,000
0603 (1608)	0.80±0.07	S	4,000	15,000
	0.50±0.10	H	4,000	-
0805 (2012)	0.60±0.10	A	4,000	15,000
	0.85±0.10	T	4,000	15,000
Size	Thickness (mm)/Symbol		Plastic tape	
			7" reel	13" reel
0505 (1414)	1.15±0.15	J	3,000	-
1111 (2828)	≤ 1.78	G	2,000	-

Unit: pieces

Multilayer Ceramic Capacitors

8. CAPACITANCE RANGE

DIELECTRIC		NP0		Tolerance
SIZE		01005		
RATED VOLTAGE (VDC)		16	25	
Capacitance	0.2pF (0R2)	V	V	A, B
	0.3pF (0R3)	V	V	A, B
	0.4pF (0R4)	V	V	A, B
	0.5pF (0R5)	V	V	A, B, C
	0.6pF (0R6)	V	V	A, B, C
	0.7pF (0R7)	V	V	A, B, C
	0.75pF (R75)	V	V	A, B, C
	0.8pF (0R8)	V	V	A, B, C
	0.9pF (0R9)	V	V	A, B, C
	1.0pF (1R0)	V	V	A, B, C
	1.2pF (1R2)	V	V	A, B, C
	1.5pF (1R5)	V	V	A, B, C
	1.8pF (1R8)	V	V	A, B, C
	2.0pF (2R0)	V	V	A, B, C
	2.2pF (2R2)	V	V	A, B, C
	2.7pF (2R7)	V	V	A, B, C
	3.0pF (3R0)	V	V	A, B, C
	3.3pF (3R3)	V	V	A, B, C
	3.9pF (3R9)	V	V	A, B, C
	4.0pF (4R0)	V	V	A, B, C
	4.7pF (4R7)	V	V	A, B, C
	5.0pF (5R0)	V	V	A, B, C
5.6pF (5R6)	V	V	B, C, D	
6.0pF (6R0)	V	V	B, C, D	
6.8pF (6R8)	V	V	B, C, D	
7.0pF (7R0)	V	V	B, C, D	
8.0pF (8R0)	V	V	B, C, D	
8.2pF (8R2)	V	V	B, C, D	
9.0pF (9R0)	V	V	B, C, D	
10pF (100)	V	V	C, D, G	
12pF (120)	V	V	J	
15pF (150)	V	V	J	
20pF (200)	V	V	J	
22pF (220)	V	V	J	

1. The letter in cell is expressed the symbol of product thickness.
2. For more information about products with special capacitance or other data, please contact WTC local representative.

Multilayer Ceramic Capacitors

DIELECTRIC		NP0								Tolerance	
SIZE		0201				0402					
RATED VOLTAGE (VDC)		6.3	10	25	50	100	25	50	100		200
Capacitance	0.1pF (0R1)	L	L	L	L	L	N	N	N*	N*	A, B
	0.2pF (0R2)	L	L	L	L	L	N	N	N	N	A, B
	0.3pF (0R3)	L	L	L	L	L	N	N	N	N	A, B
	0.4pF (0R4)	L	L	L	L	L	N	N	N	N	A, B
	0.5pF (0R5)	L	L	L	L	L	N	N	N	N	A, B, C
	0.6pF (0R6)	L	L	L	L	L	N	N	N	N	A, B, C
	0.7pF (0R7)	L	L	L	L	L	N	N	N	N	A, B, C
	0.75pF (R75)	L	L	L	L	L	N	N	N	N	A, B, C
	0.8pF (0R8)	L	L	L	L	L	N	N	N	N	A, B, C
	0.9pF (0R9)	L	L	L	L	L	N	N	N	N	A, B, C
	1.0pF (1R0)	L	L	L	L	L	N	N	N	N	A, B, C
	1.1pF (1R1)	L	L	L	L	L	N	N	N	N	A, B, C
	1.2pF (1R2)	L	L	L	L	L	N	N	N	N	A, B, C
	1.3pF (1R3)	L	L	L	L	L	N	N	N	N	A, B, C
	1.4pF (1R4)	L	L	L	L	L	N	N	N	N	A, B, C
	1.5pF (1R5)	L	L	L	L	L	N	N	N	N	A, B, C
	1.6pF (1R6)	L	L	L	L	L	N	N	N	N	A, B, C
	1.7pF (1R7)	L	L	L	L	L	N	N	N	N	A, B, C
	1.8pF (1R8)	L	L	L	L	L	N	N	N	N	A, B, C
	1.9pF (1R9)	L	L	L	L	L	N	N	N	N	A, B, C
	2.0pF (2R0)	L	L	L	L	L	N	N	N	N	A, B, C
	2.1pF (2R1)	L	L	L	L	L	N	N	N	N	A, B, C
	2.2pF (2R2)	L	L	L	L	L	N	N	N	N	A, B, C
	2.3pF (2R3)	L	L	L	L	L	N	N	N	N	A, B, C
	2.4pF (2R4)	L	L	L	L	L	N	N	N	N	A, B, C
	2.5pF (2R5)	L	L	L	L	L	N	N	N	N	A, B, C
	2.6pF (2R6)	L	L	L	L	L	N	N	N	N	A, B, C
	2.7pF (2R7)	L	L	L	L	L	N	N	N	N	A, B, C
	2.8pF (2R8)	L	L	L	L	L	N	N	N	N	A, B, C
	2.9pF (2R9)	L	L	L	L	L	N	N	N	N	A, B, C
	3.0pF (3R0)	L	L	L	L	L	N	N	N	N	A, B, C
	3.1pF (3R1)	L	L	L	L	L	N	N	N	N	A, B, C
	3.2pF (3R2)	L	L	L	L	L	N	N	N	N	A, B, C
	3.3pF (3R3)	L	L	L	L	L	N	N	N	N	A, B, C
	3.4pF (3R4)	L	L	L	L	L	N	N	N	N	A, B, C
	3.5pF (3R5)	L	L	L	L	L	N	N	N	N	A, B, C
	3.6pF (3R6)	L	L	L	L	L	N	N	N	N	A, B, C
	3.7pF (3R7)	L	L	L	L	L	N	N	N	N	A, B, C
	3.8pF (3R8)	L	L	L	L	L	N	N	N	N	A, B, C
	3.9pF (3R9)	L	L	L	L	L	N	N	N	N	A, B, C
4.0pF (4R0)	L	L	L	L	L	N	N	N	N	A, B, C	
4.1pF (4R1)	L	L	L	L	L	N	N	N	N	A, B, C	
4.2pF (4R2)	L	L	L	L	L	N	N	N	N	A, B, C	
4.3pF (4R3)	L	L	L	L	L	N	N	N	N	A, B, C	
4.4pF (4R4)	L	L	L	L	L	N	N	N	N	A, B, C	
4.5pF (4R5)	L	L	L	L	L	N	N	N	N	A, B, C	
4.6pF (4R6)	L	L	L	L	L	N	N	N	N	A, B, C	
4.7pF (4R7)	L	L	L	L	L	N	N	N	N	A, B, C	
4.8pF (4R8)	L	L	L	L	L	N	N	N	N	A, B, C	
4.9pF (4R9)	L	L	L	L	L	N	N	N	N	A, B, C	
5.0pF (5R0)	L	L	L	L	L	N	N	N	N	A, B, C	
5.1pF (5R1)	L	L	L	L	L	N	N	N	N	B, C, D	
5.2pF (5R2)	L	L	L	L	L	N	N	N	N	B, C, D	
5.3pF (5R3)	L	L	L	L	L	N	N	N	N	B, C, D	
5.4pF (5R4)	L	L	L	L	L	N	N	N	N	B, C, D	
5.5pF (5R5)	L	L	L	L	L	N	N	N	N	B, C, D	
5.6pF (5R6)	L	L	L	L	L	N	N	N	N	B, C, D	
5.7pF (5R7)	L	L	L	L	L	N	N	N	N	B, C, D	
5.8pF (5R8)	L	L	L	L	L	N	N	N	N	B, C, D	
5.9pF (5R9)	L	L	L	L	L	N	N	N	N	B, C, D	
6.0pF (6R0)	L	L	L	L	L	N	N	N	N	B, C, D	

. The letter in cell with “” mark is expressed the capacitance tolerance “B tolerance(±0.1pF)” only.

1. The letter in cell is expressed the symbol of product thickness.

2. For more information about products with special capacitance or other data, please contact WTC local representative.

Multilayer Ceramic Capacitors

Approval Sheet

DIELECTRIC		NP0								Tolerance	
SIZE		0201				0402					
RATED VOLTAGE (VDC)		6.3	10	25	50	100	25	50	100		200
Capacitance	6.1pF (6R1)	L	L	L	L	L	N	N	N	N	B, C, D
	6.2pF (6R2)	L	L	L	L	L	N	N	N	N	B, C, D
	6.3pF (6R3)	L	L	L	L	L	N	N	N	N	B, C, D
	6.4pF (6R4)	L	L	L	L	L	N	N	N	N	B, C, D
	6.5pF (6R5)	L	L	L	L	L	N	N	N	N	B, C, D
	6.6pF (6R6)	L	L	L	L	L	N	N	N	N	B, C, D
	6.7pF (6R7)	L	L	L	L	L	N	N	N	N	B, C, D
	6.8pF (6R8)	L	L	L	L	L	N	N	N	N	B, C, D
	6.9pF (6R9)	L	L	L	L	L	N	N	N	N	B, C, D
	7.0pF (7R0)	L	L	L	L	L	N	N	N	N	B, C, D
	7.1pF (7R1)	L	L	L	L	L	N	N	N	N	B, C, D
	7.2pF (7R2)	L	L	L	L	L	N	N	N	N	B, C, D
	7.3pF (7R3)	L	L	L	L	L	N	N	N	N	B, C, D
	7.4pF (7R4)	L	L	L	L	L	N	N	N	N	B, C, D
	7.5pF (7R5)	L	L	L	L	L	N	N	N	N	B, C, D
	7.6pF (7R6)	L	L	L	L	L	N	N	N	N	B, C, D
	7.7pF (7R7)	L	L	L	L	L	N	N	N	N	B, C, D
	7.8pF (7R8)	L	L	L	L	L	N	N	N	N	B, C, D
	7.9pF (7R9)	L	L	L	L	L	N	N	N	N	B, C, D
	8.0pF (8R0)	L	L	L	L	L	N	N	N	N	B, C, D
	8.1pF (8R1)	L	L	L	L	L	N	N	N	N	B, C, D
	8.2pF (8R2)	L	L	L	L	L	N	N	N	N	B, C, D
	8.3pF (8R3)	L	L	L	L	L	N	N	N	N	B, C, D
	8.4pF (8R4)	L	L	L	L	L	N	N	N	N	B, C, D
	8.5pF (8R5)	L	L	L	L	L	N	N	N	N	B, C, D
	8.6pF (8R6)	L	L	L	L	L	N	N	N	N	B, C, D
	8.7pF (8R7)	L	L	L	L	L	N	N	N	N	B, C, D
	8.8pF (8R8)	L	L	L	L	L	N	N	N	N	B, C, D
	8.9pF (8R9)	L	L	L	L	L	N	N	N	N	B, C, D
	9.0pF (9R0)	L	L	L	L	L	N	N	N	N	B, C, D
	9.1pF (9R1)	L	L	L	L	L	N	N	N	N	B, C, D
	9.2pF (9R2)	L	L	L	L	L	N	N	N	N	B, C, D
	9.3pF (9R3)	L	L	L	L	L	N	N	N	N	B, C, D
	9.4pF (9R4)	L	L	L	L	L	N	N	N	N	B, C, D
	9.5pF (9R5)	L	L	L	L	L	N	N	N	N	B, C, D
	9.6pF (9R6)	L	L	L	L	L	N	N	N	N	B, C, D
	9.7pF (9R7)	L	L	L	L	L	N	N	N	N	B, C, D
	9.8pF (9R8)	L	L	L	L	L	N	N	N	N	B, C, D
	9.9pF (9R9)	L	L	L	L	L	N	N	N	N	B, C, D
	10pF (100)	L	L	L	L	L	N	N	N	N	F, G, J
11pF (110)	L	L	L	L	L	N	N	N	N	F, G, J	
12pF (120)	L	L	L	L	L	N	N	N	N	F, G, J	
13pF (130)	L	L	L	L	L	N	N	N	N	F, G, J	
15pF (150)	L	L	L	L	L	N	N	N	N	F, G, J	
16pF (160)	L	L	L	L	L	N	N	N	N	F, G, J	
18pF (180)	L	L	L	L	L	N	N	N	N	F, G, J	
20pF (200)	L	L	L	L	L	N	N	N	N	F, G, J	
22pF (220)	L	L	L	L	L	N	N	N	N	F, G, J	
24pF (240)	L	L	L	L	L	N	N	N	N	F, G, J	
27pF (270)	L	L	L	L	L	N	N	N	N	F, G, J	
30pF (300)	L	L	L	L	L	N	N	N	N	F, G, J	
33pF (330)	L	L	L	L	L	N	N	N	N	F, G, J	
36pF (360)						N	N	N	N	F, G, J	
39pF (390)						N	N	N	N	F, G, J	
43pF (430)						N	N	N	N	F, G, J	
47pF (470)						N	N	N	N	F, G, J	
56pF (560)						N	N	N	N	F, G, J	
68pF (680)						N	N	N	N	F, G, J	
82pF (820)						N	N	N	N	F, G, J	
100pF (101)						N	N	N	N	F, G, J	

1. The letter in cell is expressed the symbol of product thickness.
2. For more information about products with special capacitance or other data, please contact WTC local representative.

Multilayer Ceramic Capacitors

Approval Sheet

DIELECTRIC		NP0										Tolerance
SIZE		0505			0603			0805				
RATED VOLTAGE (VDC)		50	100	250	50	100	250	50	100	250	500	
Capacitance	0.1pF (0R1)				H	H	H					A, B
	0.2pF (0R2)				H	H	H	A	A	A	A	A, B
	0.3pF (0R3)				S	S	S	T	T	T	T	A, B
	0.4pF (0R4)	J	J	J	S	S	S	T	T	T	T	A, B
	0.5pF (0R5)	J	J	J	S	S	S	T	T	T	T	A, B, C
	0.6pF (0R6)	J	J	J	S	S	S	T	T	T	T	A, B, C
	0.7pF (0R7)	J	J	J	S	S	S	T	T	T	T	A, B, C
	0.8pF (0R8)	J	J	J	S	S	S	T	T	T	T	A, B, C
	0.9pF (0R9)	J	J	J	S	S	S	T	T	T	T	A, B, C
	1.0pF (1R0)	J	J	J	S	S	S	T	T	T	T	A, B, C
	1.1pF (1R1)	J	J	J	S	S	S	T	T	T	T	A, B, C
	1.2pF (1R2)	J	J	J	S	S	S	T	T	T	T	A, B, C
	1.3pF (1R3)	J	J	J	S	S	S	T	T	T	T	A, B, C
	1.4pF (1R4)	J	J	J	S	S	S	T	T	T	T	A, B, C
	1.5pF (1R5)	J	J	J	S	S	S	T	T	T	T	A, B, C
	1.6pF (1R6)	J	J	J	S	S	S	T	T	T	T	A, B, C
	1.7pF (1R7)	J	J	J	S	S	S	T	T	T	T	A, B, C
	1.8pF (1R8)	J	J	J	S	S	S	T	T	T	T	A, B, C
	1.9pF (1R9)	J	J	J	S	S	S	T	T	T	T	A, B, C
	2.0pF (2R0)	J	J	J	S	S	S	T	T	T	T	A, B, C
	2.1pF (2R1)	J	J	J	S	S	S	T	T	T	T	A, B, C
	2.2pF (2R2)	J	J	J	S	S	S	T	T	T	T	A, B, C
	2.3pF (2R3)	J	J	J	S	S	S	T	T	T	T	A, B, C
	2.4pF (2R4)	J	J	J	S	S	S	T	T	T	T	A, B, C
	2.5pF (2R5)	J	J	J	S	S	S	T	T	T	T	A, B, C
	2.6pF (2R6)	J	J	J	S	S	S	T	T	T	T	A, B, C
	2.7pF (2R7)	J	J	J	S	S	S	T	T	T	T	A, B, C
	2.8pF (2R8)	J	J	J	S	S	S	T	T	T	T	A, B, C
	2.9pF (2R9)	J	J	J	S	S	S	T	T	T	T	A, B, C
	3.0pF (3R0)	J	J	J	S	S	S	T	T	T	T	A, B, C
	3.1pF (3R1)	J	J	J	S	S	S	T	T	T	T	A, B, C
	3.2pF (3R2)	J	J	J	S	S	S	T	T	T	T	A, B, C
	3.3pF (3R3)	J	J	J	S	S	S	T	T	T	T	A, B, C
	3.4pF (3R4)	J	J	J	S	S	S	T	T	T	T	A, B, C
	3.5pF (3R5)	J	J	J	S	S	S	T	T	T	T	A, B, C
	3.6pF (3R6)	J	J	J	S	S	S	T	T	T	T	A, B, C
	3.7pF (3R7)	J	J	J	S	S	S	T	T	T	T	A, B, C
	3.8pF (3R8)	J	J	J	S	S	S	T	T	T	T	A, B, C
	3.9pF (3R9)	J	J	J	S	S	S	T	T	T	T	A, B, C
	4.0pF (4R0)	J	J	J	S	S	S	T	T	T	T	A, B, C
	4.1pF (4R1)	J	J	J	S	S	S	T	T	T	T	A, B, C
	4.2pF (4R2)	J	J	J	S	S	S	T	T	T	T	A, B, C
	4.3pF (4R3)	J	J	J	S	S	S	T	T	T	T	A, B, C
	4.4pF (4R4)	J	J	J	S	S	S	T	T	T	T	A, B, C
	4.5pF (4R5)	J	J	J	S	S	S	T	T	T	T	A, B, C
	4.6pF (4R6)	J	J	J	S	S	S	T	T	T	T	A, B, C
	4.7pF (4R7)	J	J	J	S	S	S	T	T	T	T	A, B, C
	4.8pF (4R8)	J	J	J	S	S	S	T	T	T	T	A, B, C
	4.9pF (4R9)	J	J	J	S	S	S	T	T	T	T	A, B, C
	5.0pF (5R0)	J	J	J	S	S	S	T	T	T	T	A, B, C
	5.1pF (5R1)	J	J	J	S	S	S	T	T	T	T	B, C, D
	5.2pF (5R2)	J	J	J	S	S	S	T	T	T	T	B, C, D
	5.3pF (5R3)	J	J	J	S	S	S	T	T	T	T	B, C, D
	5.4pF (5R4)	J	J	J	S	S	S	T	T	T	T	B, C, D
	5.5pF (5R5)	J	J	J	S	S	S	T	T	T	T	B, C, D
	5.6pF (5R6)	J	J	J	S	S	S	T	T	T	T	B, C, D
	5.7pF (5R7)	J	J	J	S	S	S	T	T	T	T	B, C, D
	5.8pF (5R8)	J	J	J	S	S	S	T	T	T	T	B, C, D
	5.9pF (5R9)	J	J	J	S	S	S	T	T	T	T	B, C, D
	6.0pF (6R0)	J	J	J	S	S	S	T	T	T	T	B, C, D

1. The letter in cell is expressed the symbol of product thickness.
2. For more information about products with special capacitance or other data, please contact WTC local representative.

Multilayer Ceramic Capacitors

Approval Sheet

DIELECTRIC		NP0										Tolerance
SIZE		0505			0603			0805				
RATED VOLTAGE (VDC)		50	100	250	50	100	250	50	100	250	500	
Capacitance	6.1pF (6R1)	J	J	J	S	S	S	T	T	T	T	B, C, D
	6.2pF (6R2)	J	J	J	S	S	S	T	T	T	T	B, C, D
	6.3pF (6R3)	J	J	J	S	S	S	T	T	T	T	B, C, D
	6.4pF (6R4)	J	J	J	S	S	S	T	T	T	T	B, C, D
	6.5pF (6R5)	J	J	J	S	S	S	T	T	T	T	B, C, D
	6.6pF (6R6)	J	J	J	S	S	S	T	T	T	T	B, C, D
	6.7pF (6R7)	J	J	J	S	S	S	T	T	T	T	B, C, D
	6.8pF (6R8)	J	J	J	S	S	S	T	T	T	T	B, C, D
	6.9pF (6R9)	J	J	J	S	S	S	T	T	T	T	B, C, D
	7.0pF (7R0)	J	J	J	S	S	S	T	T	T	T	B, C, D
	7.1pF (7R1)	J	J	J	S	S	S	T	T	T	T	B, C, D
	7.2pF (7R2)	J	J	J	S	S	S	T	T	T	T	B, C, D
	7.3pF (7R3)	J	J	J	S	S	S	T	T	T	T	B, C, D
	7.4pF (7R4)	J	J	J	S	S	S	T	T	T	T	B, C, D
	7.5pF (7R5)	J	J	J	S	S	S	T	T	T	T	B, C, D
	7.6pF (7R6)	J	J	J	S	S	S	T	T	T	T	B, C, D
	7.7pF (7R7)	J	J	J	S	S	S	T	T	T	T	B, C, D
	7.8pF (7R8)	J	J	J	S	S	S	T	T	T	T	B, C, D
	7.9pF (7R9)	J	J	J	S	S	S	T	T	T	T	B, C, D
	8.0pF (8R0)	J	J	J	S	S	S	T	T	T	T	B, C, D
	8.1pF (8R1)	J	J	J	S	S	S	T	T	T	T	B, C, D
	8.2pF (8R2)	J	J	J	S	S	S	T	T	T	T	B, C, D
	8.3pF (8R3)	J	J	J	S	S	S	T	T	T	T	B, C, D
	8.4pF (8R4)	J	J	J	S	S	S	T	T	T	T	B, C, D
	8.5pF (8R5)	J	J	J	S	S	S	T	T	T	T	B, C, D
	8.6pF (8R6)	J	J	J	S	S	S	T	T	T	T	B, C, D
	8.7pF (8R7)	J	J	J	S	S	S	T	T	T	T	B, C, D
	8.8pF (8R8)	J	J	J	S	S	S	T	T	T	T	B, C, D
	8.9pF (8R9)	J	J	J	S	S	S	T	T	T	T	B, C, D
	9.0pF (9R0)	J	J	J	S	S	S	T	T	T	T	B, C, D
	9.1pF (9R1)	J	J	J	S	S	S	T	T	T	T	B, C, D
	9.2pF (9R2)	J	J	J	S	S	S	T	T	T	T	B, C, D
	9.3pF (9R3)	J	J	J	S	S	S	T	T	T	T	B, C, D
	9.4pF (9R4)	J	J	J	S	S	S	T	T	T	T	B, C, D
	9.5pF (9R5)	J	J	J	S	S	S	T	T	T	T	B, C, D
	9.6pF (9R6)	J	J	J	S	S	S	T	T	T	T	B, C, D
	9.7pF (9R7)	J	J	J	S	S	S	T	T	T	T	B, C, D
	9.8pF (9R8)	J	J	J	S	S	S	T	T	T	T	B, C, D
	9.9pF (9R9)	J	J	J	S	S	S	T	T	T	T	B, C, D
	10pF (100)	J	J	J	S	S	S	T	T	T	T	F, G, J
	11pF (110)	J	J	J	S	S	S	T	T	T	T	F, G, J
	12pF (120)	J	J	J	S	S	S	T	T	T	T	F, G, J
13pF (130)	J	J	J	S	S	S	T	T	T	T	F, G, J	
15pF (150)	J	J	J	S	S	S	T	T	T	T	F, G, J	
16pF (160)	J	J	J	S	S	S	T	T	T	T	F, G, J	
18pF (180)	J	J	J	S	S	S	T	T	T	T	F, G, J	
20pF (200)	J	J	J	S	S	S	T	T	T	T	F, G, J	
22pF (220)	J	J	J	S	S	S	T	T	T	T	F, G, J	
24pF (240)	J	J	J	S	S	S	T	T	T	T	F, G, J	
27pF (270)	J	J	J	S	S	S	T	T	T	T	F, G, J	
30pF (300)	J	J	J	S	S	S	T	T	T	T	F, G, J	
33pF (330)	J	J	J	S	S	S	T	T	T	T	F, G, J	
36pF (360)	J	J	J	S	S	S	T	T	T	T	F, G, J	
39pF (390)	J	J	J	S	S	S	T	T	T	T	F, G, J	
43pF (430)	J	J	J	S	S	S	T	T	T	T	F, G, J	
47pF (470)	J	J	J	S	S	S	T	T	T	T	F, G, J	
56pF (560)	J	J	J	S	S	S	T	T	T	T	F, G, J	
68pF (680)	J	J	J	S	S	S	T	T	T	T	F, G, J	
82pF (820)	J	J	J	S	S	S	T	T	T	T	F, G, J	
100pF (101)	J	J	J	S	S	S	T	T	T	T	F, G, J	
120pF (121)				S			T	T	T		F, G, J	
150pF (151)				S			T	T	T		F, G, J	
180pF (181)				S			T	T	T		F, G, J	
220pF (221)				S			T	T	T		F, G, J	

1. The letter in cell is expressed the symbol of product thickness.
2. For more information about products with special capacitance or other data, please contact WTC local representative.

Multilayer Ceramic Capacitors

DIELECTRIC		NP0						Tolerance
SIZE		1111						
RATED VOLTAGE (VDC)		50	100	200	250	500	1500	
Capacitance	1.0pF (1R0)	G	G	G	G	G	G	A, B, C
	1.1pF (1R1)	G	G	G	G	G	G	A, B, C
	1.2pF (1R2)	G	G	G	G	G	G	A, B, C
	1.3pF (1R3)	G	G	G	G	G	G	A, B, C
	1.5pF (1R5)	G	G	G	G	G	G	A, B, C
	1.6pF (1R6)	G	G	G	G	G	G	A, B, C
	1.8pF (1R8)	G	G	G	G	G	G	A, B, C
	2.0pF (2R0)	G	G	G	G	G	G	A, B, C
	2.2pF (2R2)	G	G	G	G	G	G	A, B, C
	2.4pF (2R4)	G	G	G	G	G	G	A, B, C
	2.7pF (2R7)	G	G	G	G	G	G	A, B, C
	3.0pF (3R0)	G	G	G	G	G	G	A, B, C
	3.3pF (3R3)	G	G	G	G	G	G	A, B, C
	3.6pF (3R6)	G	G	G	G	G	G	A, B, C
	3.9pF (3R9)	G	G	G	G	G	G	A, B, C
	4.0pF (4R0)	G	G	G	G	G	G	A, B, C
	4.3pF (4R3)	G	G	G	G	G	G	A, B, C
	5.0pF (5R0)	G	G	G	G	G	G	A, B, C
	5.1pF (5R1)	G	G	G	G	G	G	B, C, D
	5.6pF (5R6)	G	G	G	G	G	G	B, C, D
	6.0pF (6R0)	G	G	G	G	G	G	B, C, D
	6.8pF (6R8)	G	G	G	G	G	G	B, C, D
	7.0pF (7R0)	G	G	G	G	G	G	B, C, D
	8.0pF (8R0)	G	G	G	G	G	G	B, C, D
	8.2pF (8R2)	G	G	G	G	G	G	B, C, D
	10pF (100)	G	G	G	G	G	G	F, G, J
	12pF (120)	G	G	G	G	G	G	F, G, J
	15pF (150)	G	G	G	G	G	G	F, G, J
	18pF (180)	G	G	G	G	G	G	F, G, J
	22pF (220)	G	G	G	G	G	G	F, G, J
	27pF (270)	G	G	G	G	G	G	F, G, J
	33pF (330)	G	G	G	G	G	G	F, G, J
	39pF (390)	G	G	G	G	G	G	F, G, J
	47pF (470)	G	G	G	G	G	G	F, G, J
	56pF (560)	G	G	G	G	G	G	F, G, J
	68pF (680)	G	G	G	G	G	G	F, G, J
	82pF (820)	G	G	G	G	G	G	F, G, J
	100pF (101)	G	G	G	G	G	G	F, G, J
	120pF (121)	G	G	G	G	G	G	F, G, J
	150pF (151)	G	G	G	G	G	G	F, G, J
180pF (181)	G	G	G	G	G	G	F, G, J	
220pF (221)	G	G	G	G	G	G	F, G, J	
270pF (271)	G	G	G	G	G	G	F, G, J	
330pF (331)	G	G	G	G	G	G	F, G, J	
390pF (391)	G	G	G	G	G	G	F, G, J	
470pF (471)	G	G	G	G	G	G	F, G, J	
560pF (561)	G	G	G	G	G	G	F, G, J	
680pF (681)	G	G	G	G	G	G	F, G, J	
820pF (821)	G	G	G	G	G	G	F, G, J	
1000pF (102)	G	G	G	G	G	G	F, G, J	

1. The letter in cell is expressed the symbol of product thickness.
2. For more information about products with special capacitance or other data, please contact WTC local representative.

Multilayer Ceramic Capacitors

9. ELECTRICAL CHARACTERISTICS



Multilayer Ceramic Capacitors



Fig. 8 ESR vs. Frequency (0603 size)



Fig. 9 ESR vs. Frequency (0805 size)



Fig. 10 Q vs. Frequency (0603 size)



Fig. 11 Q vs. Frequency (0805 size)



Fig.12 Impedance vs. Frequency. (0603 size)



Fig.13 Impedance vs. Frequency (0805 size)

Multilayer Ceramic Capacitors

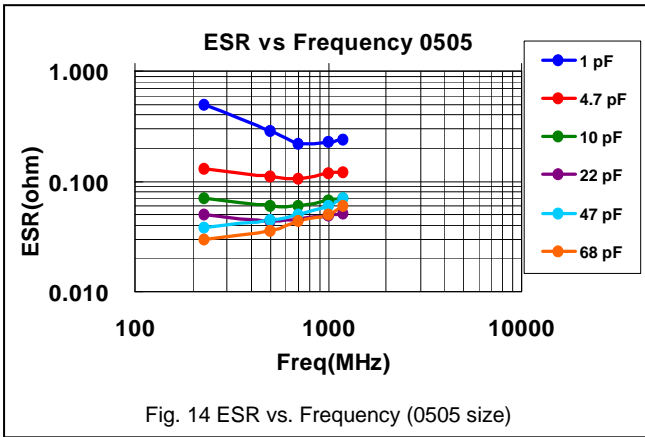

Fig. 14 ESR vs. Frequency (0505 size)



Fig. 15 ESR vs. Frequency (1111 size)

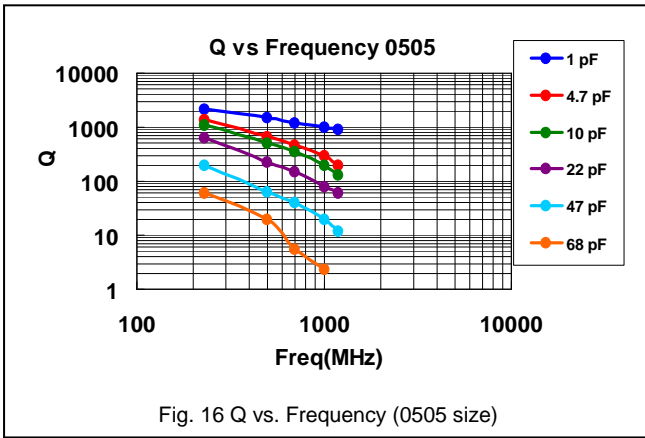

Fig. 16 Q vs. Frequency (0505 size)

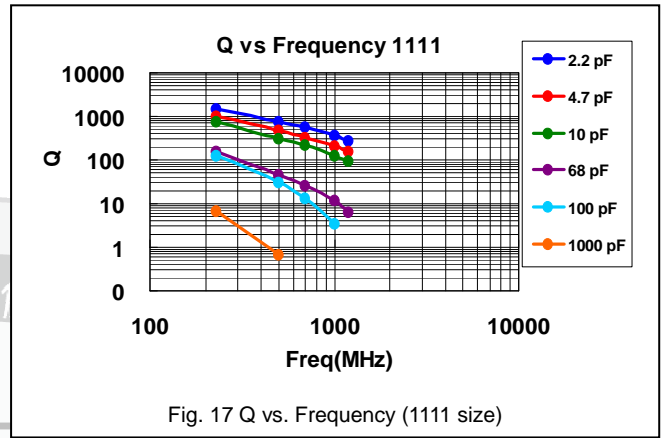

Fig. 17 Q vs. Frequency (1111 size)

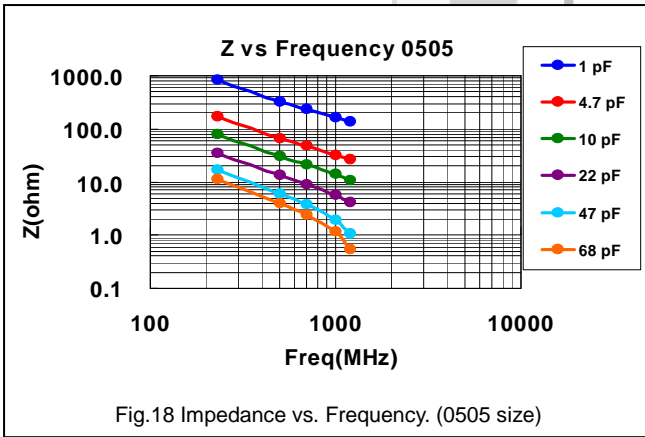

Fig.18 Impedance vs. Frequency. (0505 size)

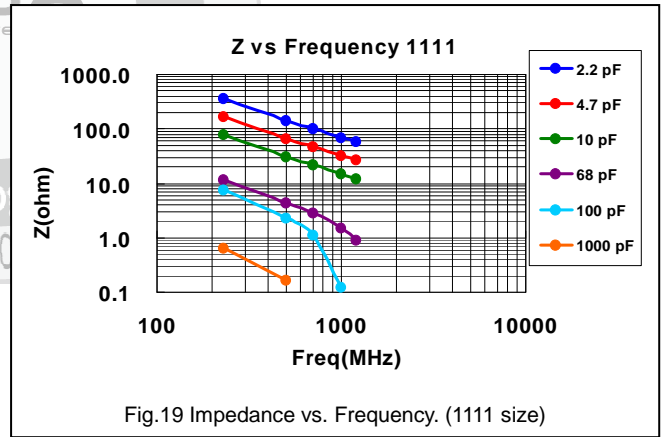

Fig.19 Impedance vs. Frequency. (1111 size)

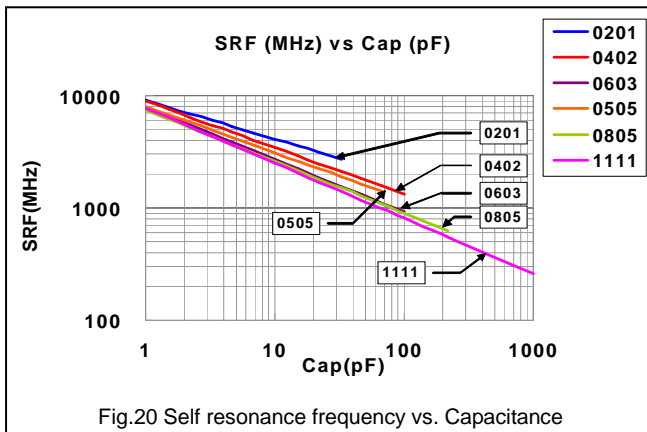

Fig.20 Self resonance frequency vs. Capacitance

Multilayer Ceramic Capacitors

10. RELIABILITY TEST CONDITIONS AND REQUIREMENTS

No.	Item	Test Conditions	Requirements
1.	Visual and Mechanical		* No remarkable defect. * Dimensions to conform to individual specification sheet.
2.	Capacitance	1.0±0.2Vrms, 1MHz±10%	* Shall not exceed the limits given in the detailed spec.
3.	Q/ D.F. (Dissipation Factor)	At 25°C ambient temperature.	* 01005, 0201, 0402/25V~50V: Cap<30pF,Q≥400+20C;Cap≥30pF, Q≥1000 * 0402/100V~200V, 0603, 0805, 0505, 1111: Cap<30pF:Q≥800+20C;Cap≥30pF:Q≥1400
4.	Dielectric Strength	*To apply voltage: ≤100V : 250% of rated voltage. 200V ~ 300V : 200% of rated voltage. 500V ~ 999V : 150% of rated voltage. 1000V ~ 3000V : 120% of rated voltage. 4000V : 110% of rated voltage. *Duration: 1 to 5 sec. *Charge & discharge current less than 50mA.	* No evidence of damage or flash over during test.
5.	Insulation Resistance	≤100V : To apply rated voltage for max. 120 sec. ≥200V :To apply rated voltage (500V max.) for 60 sec.	* ≥10GΩ or RxC≥100Ω-F whichever is smaller
6.	Temperature Coefficient	With no electrical load. Operating temperature: -55~125°C at 25°C	* Capacitance change: within ±30ppm/°C;
7.	Adhesive Strength of Termination	* Pressurizing force : 01005: 1N 0201: 2N 0402 to 0603: 5N >0603: 10N * Test time: 10±1 sec.	* No remarkable damage or removal of the terminations.
8.	Vibration Resistance	* Vibration frequency: 10~55 Hz/min. * Total amplitude: 1.5mm * Test time: 6 hrs. (Two hrs each in three mutually perpendicular directions.) *Cap./DF(Q) Measurement to be made after de-aging at 150°C for 1hr then set for 24±2 hrs at room temp.	* No remarkable damage. * Cap change and Q/D.F.: To meet initial spec.
9.	Solderability	* Solder temperature: 235±5°C * Dipping time: 2±0.5 sec.	* 95% min. coverage of all metalized area.
10.	Bending Test	* The middle part of substrate shall be pressurized by means of the pressurizing rod at a rate of about 1 mm per second until the deflection becomes 1 mm and then the pressure shall be maintained for 5±1 sec. * Measurement to be made after keeping at room temp. for 24±2 hrs.	* No remarkable damage. * Cap change: within ±5.0% or ±0.5pF whichever is larger. (This capacitance change means the change of capacitance under specified flexure of substrate from the capacitance measured before the test.)
11.	Resistance to Soldering Heat	* Solder temperature: 260±5°C * Dipping time: 10±1 sec * Preheating: 120 to 150°C for 1 minute before immerse the capacitor in a eutectic solder. *Cap. / DF(Q) / I.R. Measurement to be made after de-aging at 150°C for 1hr then set for 24±2 hrs at room temp.	* No remarkable damage. * Cap change: within ±2.5% or ±0.25pF whichever is larger. * Q/D.F., I.R. and dielectric strength: To meet initial requirements. * 25% max. leaching on each edge.

Multilayer Ceramic Capacitors

No.	Item	Test Condition	Requirements													
12.	Temperature Cycle	* Conduct the five cycles according to the temperatures and time.	* No remarkable damage.													
		<table border="1"> <thead> <tr> <th>Step</th> <th>Temp. (°C)</th> <th>Time (min.)</th> </tr> </thead> <tbody> <tr> <td>1</td> <td>Min. operating temp. +0/-3</td> <td>30±3</td> </tr> <tr> <td>2</td> <td>Room temp.</td> <td>2~3</td> </tr> <tr> <td>3</td> <td>Max. operating temp. +3/-0</td> <td>30±3</td> </tr> <tr> <td>4</td> <td>Room temp.</td> <td>2~3</td> </tr> </tbody> </table>	Step	Temp. (°C)	Time (min.)	1	Min. operating temp. +0/-3	30±3	2	Room temp.	2~3	3	Max. operating temp. +3/-0	30±3	4	Room temp.
Step	Temp. (°C)	Time (min.)														
1	Min. operating temp. +0/-3	30±3														
2	Room temp.	2~3														
3	Max. operating temp. +3/-0	30±3														
4	Room temp.	2~3														
		* Q/D.F., I.R. and dielectric strength: To meet initial requirements.														
		* Cap. / DF(Q) / I.R. Measurement to be made after de-aging at 150°C for 1hr then set for 24±2 hrs at room temp.														
13.	Humidity (Damp Heat) Steady State	* Test temp.: 40±2°C	* No remarkable damage.													
		* Humidity: 90~95% RH	* Cap change: within ±5.0% or ±0.5pF whichever is larger.													
		* Test time: 500+24/-0hrs.	* Q/D.F. value: Cap≥30pF, Q≥350;													
		* Cap. / DF(Q) / I.R. Measurement to be made after de-aging at 150°C for 1hr then set for 24±2 hrs at room temp.	10pF≤Cap<30pF, Q≥275+2.5C Cap<10pF; Q≥200+10C													
			* I.R.: ≥1GΩ.													
14.	Humidity (Damp Heat) Load	* Test temp.: 40±2°C	* No remarkable damage.													
		* Humidity: 90~95%RH	* Cap change: within ±7.5% or ±0.75pF whichever is larger.													
		* Test time: 500+24/-0 hrs.	* Q/D.F. value: Cap≥30pF, Q≥200;													
		* To apply voltage : rated voltage (MAX. 500V)	Cap<30pF, Q≥100+10/3C													
		* Cap. / DF(Q) / I.R. Measurement to be made after de-aging at 150°C for 1hr then set for 24±2 hrs at room temp.	* I.R.: ≥500MΩ.													
15.	High Temperature Load (Endurance)	* Test temp.: 125±3°C	* No remarkable damage.													
		* To apply voltage:	* Cap change: within ±3.0% or ±0.3pF whichever is larger.													
		(1) 10V ≤ Ur < 500V: 200% of rated voltage.	* Q/D.F. value: Cap≥30pF, Q≥350													
		(2) ≤ 6.3V or 500V: 150% of rated voltage.	10pF≤Cap<30pF, Q≥275+2.5C													
		(3) Ur ≥ 630V: 120% of rated voltage.	Cap<10pF, Q≥200+10C													
		* Test time: 1000+24/-0 hrs.	* I.R.: ≥1GΩ.													
		* Cap. / DF(Q) / I.R. Measurement to be made after de-aging at 150°C for 1hr then set for 24±2 hrs at room temp														
16.	ESR	The ESR should be measured at room temperature and tested at frequency 1±0.1 GHz.	01005													
			0505													
			0.2pF≤Cap≤1pF:< 700mΩ/pF	0.4pF≤Cap<1.0pF: < 1500mΩ												
			1pF<Cap≤2pF:< 600mΩ	1.0pF≤Cap<10pF: < 250mΩ												
			2pF<Cap≤5pF:< 500mΩ	10pF≤Cap≤100pF: < 200mΩ												
			5pF<Cap≤10pF:< 300mΩ													
			10pF<Cap≤22pF:< 350mΩ													
			0201	0402												
			0.1pF≤Cap≤1pF:< 350mΩ/pF	0.1pF≤Cap≤1pF:< 350mΩ/pF												
			1pF<Cap≤5pF:< 300mΩ	1pF<Cap≤5pF:< 300mΩ												
			5pF<Cap≤22pF:< 250mΩ	5pF<Cap≤100pF:< 250mΩ												
			0603	0805												
			0.3pF≤Cap≤1pF:< 1500mΩ	0.3pF≤Cap≤1pF: < 1500mΩ												
			1pF<Cap≤10pF:< 250mΩ	1pF<Cap≤10pF: < 250mΩ												
			10pF<Cap≤220pF:< 200mΩ	Cap>10pF: < 200mΩ												
	0201, 22pF≤Cap≤33pF: < 300mΩ															
	The ESR should be measured at room temperature and tested at frequency 500±50 MHz.															

Multilayer Ceramic Capacitors

APPENDIXES

▣ Tape & reel dimensions



Fig. 21 The dimension of paper tape



Fig. 22 The dimension of plastic tape



Fig. 23 The dimension of reel

Size	01005	0201	0402	0505	0603	0805	1111
Thickness	V	L	N	J	S	T	G
A ₀	0.25 +/-0.05	0.40 +/-0.10	0.70 +/-0.20	< 1.90	1.05 +/-0.30	1.50 +/-0.20	< 3.05
B ₀	0.45 +/-0.05	0.70 +/-0.10	1.20 +/-0.20	< 1.90	1.80 +/-0.30	2.30 +/-0.20	< 3.80
T	≤ 0.50	≤ 0.55	≤ 0.80	0.23 +/-0.1	≤ 1.20	≤ 1.20	0.23 +/-0.1
K ₀	-	-	-	< 1.50	-	-	< 2.50
W	8.00 +/-0.30	8.00 +/-0.30	8.00 +/-0.30	8.00 +/-0.30	8.00 +/-0.30	8.00 +/-0.30	8.00 +/-0.30
P ₀	4.00 +/-0.10	4.00 +/-0.10	4.00 +/-0.10	4.00 +/-0.10	4.00 +/-0.10	4.00 +/-0.10	4.00 +/-0.10
10xP ₀	40.00 +/-0.10	40.00 +/-0.10	40.00 +/-0.10	40.00 +/-0.20	40.00 +/-0.20	40.00 +/-0.20	40.00 +/-0.20
P ₁	2.00 +/-0.05	2.00 +/-0.05	2.00 +/-0.05	4.00 +/-0.10	4.00 +/-0.10	4.00 +/-0.10	4.00 +/-0.10
P ₂	2.00 +/-0.05	2.00 +/-0.05	2.00 +/-0.05	2.00 +/-0.05	2.00 +/-0.05	2.00 +/-0.05	2.00 +/-0.05
D ₀	1.50 +0.1/-0	1.50 +0.1/-0	1.50 +0.1/-0	1.50 +0.1/-0	1.50 +0.1/-0	1.50 +0.1/-0	1.50 +0.1/-0
D ₁	-	-	-	1.00 +/-0.10	-	-	1.00 +/-0.10
E	1.75 +/-0.10	1.75 +/-0.10	1.75 +/-0.10	1.75 +/-0.10	1.75 +/-0.10	1.75 +/-0.10	1.75 +/-0.10
F	3.50 +/-0.05	3.50 +/-0.05	3.50 +/-0.05	3.50 +/-0.05	3.50 +/-0.05	3.50 +/-0.05	3.50 +/-0.05

Size	01005, 0201, 0402, 0505, 0603, 0805, 1111	
Reel size	7"	13"
C	13.0+0.5/-0.2	13.0+0.5/-0.2
W ₁	8.4+1.5/-0	8.4+1.5/-0
A	178.0±1.0	330.0±1.0
N	60.0+1.0/-0	100±1.0

▣ Example of customer label



*Customized label is available upon request

- a. Customer name
- b. WTC order series and item number
- c. Customer P/O
- d. Customer P/N
- e. Description of product
- f. Quantity
- g. Bar code including quantity & WTC P/N or customer
- h. WTC P/N
- i. Shipping date
- j. Order bar code including series and item numbers
- k. Serial number of label

Multilayer Ceramic Capacitors

Constructions

No.	Name	NPO
①	Ceramic material	Hi-Q dielectric ceramic
②	Inner electrode	Cu
③	Termination	Inner layer
④		Middle layer
⑤		Outer layer
		Sn (Matt)

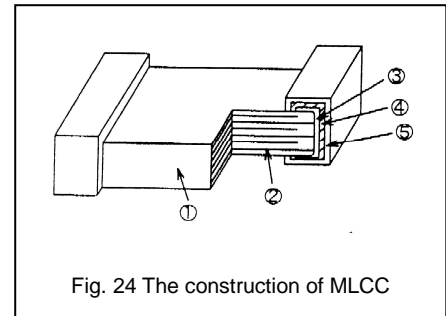

Fig. 24 The construction of MLCC

Storage and handling conditions

- (1) To store products at 5 to 40°C ambient temperature and 20 to 70% related humidity conditions.
- (2) The product is recommended to be used within one year after shipment. Check solderability in case of shelf life extension is needed.

Cautions:

- a. The corrosive gas reacts on the terminal electrodes of capacitors, and results in the poor solderability. Do not store the capacitors in the ambience of corrosive gas (e.g., hydrogen sulfide, sulfur dioxide, chlorine, ammonia gas etc.)
- b. In corrosive atmosphere, solderability might be degraded, and silver migration might occur to cause low reliability.
- c. Due to the dewing by rapid humidity change, or the photochemical change of the terminal electrode by direct sunlight, the solderability and electrical performance may deteriorate. Do not store capacitors under direct sunlight or dewing condition. To store products on the shelf and avoid exposure to moisture.

Recommended soldering conditions

The lead-free termination MLCCs are not only to be used on SMT against lead-free solder paste, but also suitable against lead-containing solder paste. If the optimized solder joint is requested, increasing soldering time, temperature and concentration of N₂ within oven are recommended.

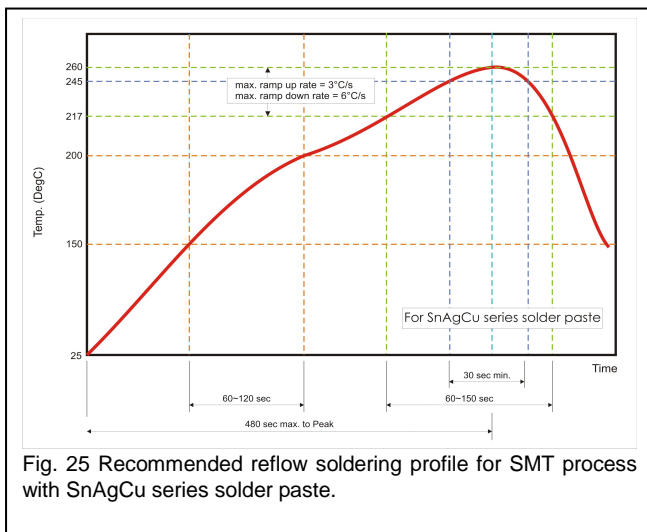

Fig. 25 Recommended reflow soldering profile for SMT process with SnAgCu series solder paste.

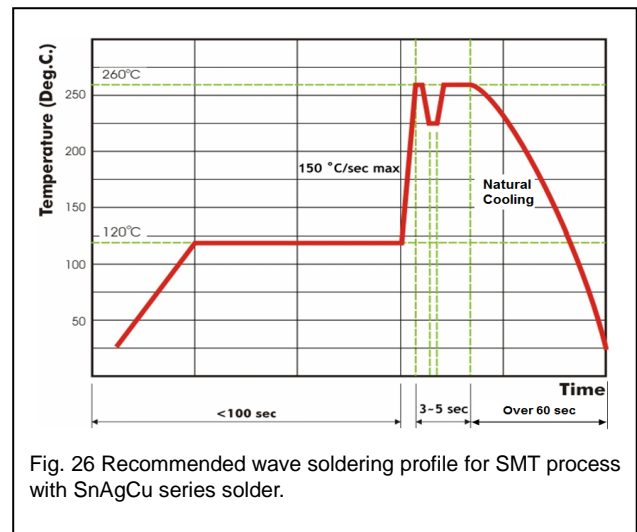

Fig. 26 Recommended wave soldering profile for SMT process with SnAgCu series solder.

Компания «Океан Электроники» предлагает заключение долгосрочных отношений при поставках импортных электронных компонентов на взаимовыгодных условиях!

Наши преимущества:

- Поставка оригинальных импортных электронных компонентов напрямую с производств Америки, Европы и Азии, а так же с крупнейших складов мира;
- Широкая линейка поставок активных и пассивных импортных электронных компонентов (более 30 млн. наименований);
- Поставка сложных, дефицитных, либо снятых с производства позиций;
- Оперативные сроки поставки под заказ (от 5 рабочих дней);
- Экспресс доставка в любую точку России;
- Помощь Конструкторского Отдела и консультации квалифицированных инженеров;
- Техническая поддержка проекта, помощь в подборе аналогов, поставка прототипов;
- Поставка электронных компонентов под контролем ВП;
- Система менеджмента качества сертифицирована по Международному стандарту ISO 9001;
- При необходимости вся продукция военного и аэрокосмического назначения проходит испытания и сертификацию в лаборатории (по согласованию с заказчиком);
- Поставка специализированных компонентов военного и аэрокосмического уровня качества (Xilinx, Altera, Analog Devices, Intersil, Interpoint, Microsemi, Actel, Aeroflex, Peregrine, VPT, Syfer, Eurofarad, Texas Instruments, MS Kennedy, Miteq, Cobham, E2V, MA-COM, Hittite, Mini-Circuits, General Dynamics и др.);

Компания «Океан Электроники» является официальным дистрибьютором и эксклюзивным представителем в России одного из крупнейших производителей разъемов военного и аэрокосмического назначения «JONHON», а так же официальным дистрибьютором и эксклюзивным представителем в России производителя высокотехнологичных и надежных решений для передачи СВЧ сигналов «FORSTAR».



JONHON

«JONHON» (основан в 1970 г.)

Разъемы специального, военного и аэрокосмического назначения:

(Применяются в военной, авиационной, аэрокосмической, морской, железнодорожной, горно- и нефтедобывающей отраслях промышленности)

«FORSTAR» (основан в 1998 г.)

ВЧ соединители, коаксиальные кабели, кабельные сборки и микроволновые компоненты:

(Применяются в телекоммуникациях гражданского и специального назначения, в средствах связи, РЛС, а так же военной, авиационной и аэрокосмической отраслях промышленности).



Телефон: 8 (812) 309-75-97 (многоканальный)

Факс: 8 (812) 320-03-32

Электронная почта: ocean@oceanchips.ru

Web: <http://oceanchips.ru/>

Адрес: 198099, г. Санкт-Петербург, ул. Калинина, д. 2, корп. 4, лит. А