

# APPROVAL SHEET

## MULTILAYER CERAMIC CAPACITORS

Microwave Series (RF)

01005 to 1111 Sizes (6.3V to 1500V)

NP0 Dielectric

Halogen Free & RoHS Compliance



\*Contents in this sheet are subject to change without prior notice.

**Multilayer Ceramic Capacitors**

**1. INTRODUCTION**

MLCC consists of a conducting material and electrodes. To manufacture a chip-type SMT and achieve miniaturization, high density and high efficiency, ceramic condensers are used.

WTC RF series MLCC is used at high frequencies generally have a small temperature coefficient of capacitance, typical within the  $\pm 30\text{ppm}/^\circ\text{C}$  required for NP0 (C0G) classification and have excellent conductivity internal electrode. Thus, WTC RF series MLCC will be with the feature of low ESR and high Q characteristics.

**2. FEATURES**

- a. High Q and low ESR performance at high frequency.
- b. Ultra low capacitance to 0.1pF.
- c. Can offer high precision tolerance to  $\pm 0.05\text{pF}$ .
- d. Quality improvement of telephone calls for low power loss and better performance.

**3. APPLICATIONS**

- a. Telecommunication products & equipments: Mobile phone, WLAN, Base station.
- b. RF module: Power amplifier, VCO.
- c. Tuners.

**4. HOW TO ORDER**

<u>RF</u>	<u>15</u>	<u>N</u>	<u>100</u>	<u>J</u>	<u>500</u>	<u>C</u>	<u>I</u>
<u>Series</u>	<u>Size</u>	<u>Dielectric</u>	<u>Capacitance</u>	<u>Tolerance</u>	<u>Rated voltage</u>	<u>Termination</u>	<u>Packaging</u>
RF=Ultra High Q & Low ESR	02=01005(0402) 03=0201 (0603) 15=0402 (1005) 18=0603 (1608) 11=0505 (1414) 21=0805 (2012) 22=1111 (2828)	N=NP0	Two significant digits followed by no. of zeros. And R is in place of decimal point. eg.: 0R5=0.5pF 1R0=1.0pF 100=10x10 <sup>0</sup> =10pF	A= $\pm 0.05\text{pF}$ B= $\pm 0.1\text{pF}$ C= $\pm 0.25\text{pF}$ D= $\pm 0.5\text{pF}$ F= $\pm 1\%$ G= $\pm 2\%$ J= $\pm 5\%$	Two significant digits followed by no. of zeros. And R is in place of decimal point. <b>6R3=6.3 VDC</b> <b>100=10 VDC</b> <b>250=25 VDC</b> <b>500=50 VDC</b> <b>101=100 VDC</b> <b>201=200 VDC</b> <b>251=250 VDC</b> <b>501=500 VDC</b> <b>152=1500 VDC</b>	C=Cu/Ni/Sn	T=7" reeled G= 13" reeled

Multilayer Ceramic Capacitors

**5. EXTERNAL DIMENSIONS**

Size Inch (mm)	L (mm)	W (mm)	T (mm)/Symbol	Remark	M <sub>B</sub> (mm)
01005 (0402)	0.40±0.02	0.20±0.02	0.20±0.02	V #	0.10±0.03
0201 (0603)	0.60±0.03	0.30±0.03	0.30±0.03	L #	0.15±0.05
0402 (1005)	1.00±0.05	0.50±0.05	0.50±0.05	N #	0.25±0.05/-0.10
0603 (1608)	1.60±0.10	0.80±0.10	0.80±0.07	S	0.40±0.15
	1.60 +0.15/-0.10	0.80 +0.15/-0.10	0.50±0.10	H	
0805 (2012)	2.00±0.15	1.25±0.10	0.60±0.10	A	0.50±0.20
	2.00±0.20	1.25±0.20	0.85±0.10	T	
0505 (1414)	1.40 +0.38/-0.25	1.40±0.38	1.15±0.15	J #	0.25±0.25/-0.13
1111 (2828)	2.79 +0.51/-0.25	2.79±0.38	≤ 1.78	G #	0.38±0.25



# Reflow soldering only is recommended.

**6. GENERAL ELECTRICAL DATA**

<b>Dielectric</b>	NP0
<b>Size</b>	01005, 0201, 0402, 0505, 0603, 0805, 1111
<b>Capacitance*</b>	0.1pF to 1000pF
<b>Capacitance tolerance</b>	Cap≤5pF: A (±0.05pF), B (±0.1pF), C (±0.25pF) 5pF<Cap<10pF: B (±0.1pF), C (±0.25pF), D (±0.5pF) Cap≥10pF: F (±1%), G (±2%), J (±5%)
<b>Rated voltage (WVDC)</b>	6.3V, 10V, 25V, 50V, 100V, 200V, 250V, 500V, 1500V
<b>Q*</b>	01005, 0201, 0402/25V~50V: Cap<30pF:Q≥400+20C; Cap≥30pF:Q≥1000 0402/100V~200V, 0603, 0805, 0505, 1111: Cap<30pF:Q≥800+20C; Cap≥30pF:Q≥1400
<b>Insulation resistance at U<sub>r</sub></b>	≥10GΩ or R <sub>x</sub> C≥100Ω·F whichever is smaller.
<b>Operating temperature</b>	-55 to +125°C
<b>Capacitance change</b>	±30ppm/°C
<b>Termination</b>	Ni/Sn (lead-free termination)

\* Measured at the conditions of 25°C ambient temperature and 30~70% related humidity.

Apply 1.0±0.2Vrms, 1.0MHz±10% for Cap≤1000pF and 1.0±0.2Vrms, 1.0kHz±10% for Cap>1000pF.

**7. PACKAGING DIMENSION AND QUANTITY**

Size	Thickness (mm)/Symbol		Paper tape	
			7" reel	13" reel
01005 (0402)	0.20±0.02	V	20,000	-
0201 (0603)	0.30±0.03	L	15,000	70,000
0402 (1005)	0.50±0.05	N	10,000	50,000
0603 (1608)	0.80±0.07	S	4,000	15,000
	0.50±0.10	H	4,000	-
0805 (2012)	0.60±0.10	A	4,000	15,000
	0.85±0.10	T	4,000	15,000
Size	Thickness (mm)/Symbol		Plastic tape	
			7" reel	13" reel
0505 (1414)	1.15±0.15	J	3,000	-
1111 (2828)	≤ 1.78	G	2,000	-

Unit: pieces

Multilayer Ceramic Capacitors

**8. CAPACITANCE RANGE**

DIELECTRIC		NP0		Tolerance
SIZE		01005		
RATED VOLTAGE (VDC)		16	25	
Capacitance	0.2pF (0R2)	V	V	A, B
	0.3pF (0R3)	V	V	A, B
	0.4pF (0R4)	V	V	A, B
	0.5pF (0R5)	V	V	A, B, C
	0.6pF (0R6)	V	V	A, B, C
	0.7pF (0R7)	V	V	A, B, C
	0.75pF (R75)	V	V	A, B, C
	0.8pF (0R8)	V	V	A, B, C
	0.9pF (0R9)	V	V	A, B, C
	1.0pF (1R0)	V	V	A, B, C
	1.2pF (1R2)	V	V	A, B, C
	1.5pF (1R5)	V	V	A, B, C
	1.8pF (1R8)	V	V	A, B, C
	2.0pF (2R0)	V	V	A, B, C
	2.2pF (2R2)	V	V	A, B, C
	2.7pF (2R7)	V	V	A, B, C
	3.0pF (3R0)	V	V	A, B, C
	3.3pF (3R3)	V	V	A, B, C
	3.9pF (3R9)	V	V	A, B, C
	4.0pF (4R0)	V	V	A, B, C
	4.7pF (4R7)	V	V	A, B, C
	5.0pF (5R0)	V	V	A, B, C
5.6pF (5R6)	V	V	B, C, D	
6.0pF (6R0)	V	V	B, C, D	
6.8pF (6R8)	V	V	B, C, D	
7.0pF (7R0)	V	V	B, C, D	
8.0pF (8R0)	V	V	B, C, D	
8.2pF (8R2)	V	V	B, C, D	
9.0pF (9R0)	V	V	B, C, D	
10pF (100)	V	V	C, D, G	
12pF (120)	V	V	J	
15pF (150)	V	V	J	
20pF (200)	V	V	J	
22pF (220)	V	V	J	

1. The letter in cell is expressed the symbol of product thickness.
2. For more information about products with special capacitance or other data, please contact WTC local representative.

Multilayer Ceramic Capacitors

DIELECTRIC		NP0								Tolerance	
SIZE		0201				0402					
RATED VOLTAGE (VDC)		6.3	10	25	50	100	25	50	100		200
Capacitance	0.1pF (0R1)	L	L	L	L	L	N	N	N*	N*	A, B
	0.2pF (0R2)	L	L	L	L	L	N	N	N	N	A, B
	0.3pF (0R3)	L	L	L	L	L	N	N	N	N	A, B
	0.4pF (0R4)	L	L	L	L	L	N	N	N	N	A, B
	0.5pF (0R5)	L	L	L	L	L	N	N	N	N	A, B, C
	0.6pF (0R6)	L	L	L	L	L	N	N	N	N	A, B, C
	0.7pF (0R7)	L	L	L	L	L	N	N	N	N	A, B, C
	0.75pF (R75)	L	L	L	L	L	N	N	N	N	A, B, C
	0.8pF (0R8)	L	L	L	L	L	N	N	N	N	A, B, C
	0.9pF (0R9)	L	L	L	L	L	N	N	N	N	A, B, C
	1.0pF (1R0)	L	L	L	L	L	N	N	N	N	A, B, C
	1.1pF (1R1)	L	L	L	L	L	N	N	N	N	A, B, C
	1.2pF (1R2)	L	L	L	L	L	N	N	N	N	A, B, C
	1.3pF (1R3)	L	L	L	L	L	N	N	N	N	A, B, C
	1.4pF (1R4)	L	L	L	L	L	N	N	N	N	A, B, C
	1.5pF (1R5)	L	L	L	L	L	N	N	N	N	A, B, C
	1.6pF (1R6)	L	L	L	L	L	N	N	N	N	A, B, C
	1.7pF (1R7)	L	L	L	L	L	N	N	N	N	A, B, C
	1.8pF (1R8)	L	L	L	L	L	N	N	N	N	A, B, C
	1.9pF (1R9)	L	L	L	L	L	N	N	N	N	A, B, C
	2.0pF (2R0)	L	L	L	L	L	N	N	N	N	A, B, C
	2.1pF (2R1)	L	L	L	L	L	N	N	N	N	A, B, C
	2.2pF (2R2)	L	L	L	L	L	N	N	N	N	A, B, C
	2.3pF (2R3)	L	L	L	L	L	N	N	N	N	A, B, C
	2.4pF (2R4)	L	L	L	L	L	N	N	N	N	A, B, C
	2.5pF (2R5)	L	L	L	L	L	N	N	N	N	A, B, C
	2.6pF (2R6)	L	L	L	L	L	N	N	N	N	A, B, C
	2.7pF (2R7)	L	L	L	L	L	N	N	N	N	A, B, C
	2.8pF (2R8)	L	L	L	L	L	N	N	N	N	A, B, C
	2.9pF (2R9)	L	L	L	L	L	N	N	N	N	A, B, C
	3.0pF (3R0)	L	L	L	L	L	N	N	N	N	A, B, C
	3.1pF (3R1)	L	L	L	L	L	N	N	N	N	A, B, C
	3.2pF (3R2)	L	L	L	L	L	N	N	N	N	A, B, C
	3.3pF (3R3)	L	L	L	L	L	N	N	N	N	A, B, C
	3.4pF (3R4)	L	L	L	L	L	N	N	N	N	A, B, C
	3.5pF (3R5)	L	L	L	L	L	N	N	N	N	A, B, C
	3.6pF (3R6)	L	L	L	L	L	N	N	N	N	A, B, C
	3.7pF (3R7)	L	L	L	L	L	N	N	N	N	A, B, C
	3.8pF (3R8)	L	L	L	L	L	N	N	N	N	A, B, C
	3.9pF (3R9)	L	L	L	L	L	N	N	N	N	A, B, C
	4.0pF (4R0)	L	L	L	L	L	N	N	N	N	A, B, C
	4.1pF (4R1)	L	L	L	L	L	N	N	N	N	A, B, C
	4.2pF (4R2)	L	L	L	L	L	N	N	N	N	A, B, C
	4.3pF (4R3)	L	L	L	L	L	N	N	N	N	A, B, C
	4.4pF (4R4)	L	L	L	L	L	N	N	N	N	A, B, C
	4.5pF (4R5)	L	L	L	L	L	N	N	N	N	A, B, C
	4.6pF (4R6)	L	L	L	L	L	N	N	N	N	A, B, C
	4.7pF (4R7)	L	L	L	L	L	N	N	N	N	A, B, C
	4.8pF (4R8)	L	L	L	L	L	N	N	N	N	A, B, C
	4.9pF (4R9)	L	L	L	L	L	N	N	N	N	A, B, C
	5.0pF (5R0)	L	L	L	L	L	N	N	N	N	A, B, C
	5.1pF (5R1)	L	L	L	L	L	N	N	N	N	B, C, D
	5.2pF (5R2)	L	L	L	L	L	N	N	N	N	B, C, D
	5.3pF (5R3)	L	L	L	L	L	N	N	N	N	B, C, D
	5.4pF (5R4)	L	L	L	L	L	N	N	N	N	B, C, D
	5.5pF (5R5)	L	L	L	L	L	N	N	N	N	B, C, D
	5.6pF (5R6)	L	L	L	L	L	N	N	N	N	B, C, D
	5.7pF (5R7)	L	L	L	L	L	N	N	N	N	B, C, D
	5.8pF (5R8)	L	L	L	L	L	N	N	N	N	B, C, D
	5.9pF (5R9)	L	L	L	L	L	N	N	N	N	B, C, D
6.0pF (6R0)	L	L	L	L	L	N	N	N	N	B, C, D	

\*. The letter in cell with “\*” mark is expressed the capacitance tolerance “B tolerance(±0.1pF)” only.

1. The letter in cell is expressed the symbol of product thickness.

2. For more information about products with special capacitance or other data, please contact WTC local representative.

DIELECTRIC		NP0								Tolerance	
SIZE		0201				0402					
RATED VOLTAGE (VDC)		6.3	10	25	50	100	25	50	100		200
Capacitance	6.1pF (6R1)	L	L	L	L	L	N	N	N	N	B, C, D
	6.2pF (6R2)	L	L	L	L	L	N	N	N	N	B, C, D
	6.3pF (6R3)	L	L	L	L	L	N	N	N	N	B, C, D
	6.4pF (6R4)	L	L	L	L	L	N	N	N	N	B, C, D
	6.5pF (6R5)	L	L	L	L	L	N	N	N	N	B, C, D
	6.6pF (6R6)	L	L	L	L	L	N	N	N	N	B, C, D
	6.7pF (6R7)	L	L	L	L	L	N	N	N	N	B, C, D
	6.8pF (6R8)	L	L	L	L	L	N	N	N	N	B, C, D
	6.9pF (6R9)	L	L	L	L	L	N	N	N	N	B, C, D
	7.0pF (7R0)	L	L	L	L	L	N	N	N	N	B, C, D
	7.1pF (7R1)	L	L	L	L	L	N	N	N	N	B, C, D
	7.2pF (7R2)	L	L	L	L	L	N	N	N	N	B, C, D
	7.3pF (7R3)	L	L	L	L	L	N	N	N	N	B, C, D
	7.4pF (7R4)	L	L	L	L	L	N	N	N	N	B, C, D
	7.5pF (7R5)	L	L	L	L	L	N	N	N	N	B, C, D
	7.6pF (7R6)	L	L	L	L	L	N	N	N	N	B, C, D
	7.7pF (7R7)	L	L	L	L	L	N	N	N	N	B, C, D
	7.8pF (7R8)	L	L	L	L	L	N	N	N	N	B, C, D
	7.9pF (7R9)	L	L	L	L	L	N	N	N	N	B, C, D
	8.0pF (8R0)	L	L	L	L	L	N	N	N	N	B, C, D
	8.1pF (8R1)	L	L	L	L	L	N	N	N	N	B, C, D
	8.2pF (8R2)	L	L	L	L	L	N	N	N	N	B, C, D
	8.3pF (8R3)	L	L	L	L	L	N	N	N	N	B, C, D
	8.4pF (8R4)	L	L	L	L	L	N	N	N	N	B, C, D
	8.5pF (8R5)	L	L	L	L	L	N	N	N	N	B, C, D
	8.6pF (8R6)	L	L	L	L	L	N	N	N	N	B, C, D
	8.7pF (8R7)	L	L	L	L	L	N	N	N	N	B, C, D
	8.8pF (8R8)	L	L	L	L	L	N	N	N	N	B, C, D
	8.9pF (8R9)	L	L	L	L	L	N	N	N	N	B, C, D
	9.0pF (9R0)	L	L	L	L	L	N	N	N	N	B, C, D
	9.1pF (9R1)	L	L	L	L	L	N	N	N	N	B, C, D
	9.2pF (9R2)	L	L	L	L	L	N	N	N	N	B, C, D
	9.3pF (9R3)	L	L	L	L	L	N	N	N	N	B, C, D
	9.4pF (9R4)	L	L	L	L	L	N	N	N	N	B, C, D
	9.5pF (9R5)	L	L	L	L	L	N	N	N	N	B, C, D
	9.6pF (9R6)	L	L	L	L	L	N	N	N	N	B, C, D
	9.7pF (9R7)	L	L	L	L	L	N	N	N	N	B, C, D
	9.8pF (9R8)	L	L	L	L	L	N	N	N	N	B, C, D
	9.9pF (9R9)	L	L	L	L	L	N	N	N	N	B, C, D
	10pF (100)	L	L	L	L	L	N	N	N	N	F, G, J
11pF (110)	L	L	L	L	L	N	N	N	N	F, G, J	
12pF (120)	L	L	L	L	L	N	N	N	N	F, G, J	
13pF (130)	L	L	L	L	L	N	N	N	N	F, G, J	
15pF (150)	L	L	L	L	L	N	N	N	N	F, G, J	
16pF (160)	L	L	L	L	L	N	N	N	N	F, G, J	
18pF (180)	L	L	L	L	L	N	N	N	N	F, G, J	
20pF (200)	L	L	L	L	L	N	N	N	N	F, G, J	
22pF (220)	L	L	L	L	L	N	N	N	N	F, G, J	
24pF (240)	L	L	L	L	L	N	N	N	N	F, G, J	
27pF (270)	L	L	L	L	L	N	N	N	N	F, G, J	
30pF (300)	L	L	L	L	L	N	N	N	N	F, G, J	
33pF (330)	L	L	L	L	L	N	N	N	N	F, G, J	
36pF (360)						N	N	N	N	F, G, J	
39pF (390)						N	N	N	N	F, G, J	
43pF (430)						N	N	N	N	F, G, J	
47pF (470)						N	N	N	N	F, G, J	
56pF (560)						N	N	N	N	F, G, J	
68pF (680)						N	N	N	N	F, G, J	
82pF (820)						N	N	N	N	F, G, J	
100pF (101)						N	N	N	N	F, G, J	

1. The letter in cell is expressed the symbol of product thickness.
2. For more information about products with special capacitance or other data, please contact WTC local representative.

Multilayer Ceramic Capacitors

Approval Sheet

DIELECTRIC		NP0										Tolerance
SIZE		0505			0603			0805				
RATED VOLTAGE (VDC)		50	100	250	50	100	250	50	100	250	500	
Capacitance	0.1pF (0R1)				H	H	H					A, B
	0.2pF (0R2)				H	H	H	A	A	A	A	A, B
	0.3pF (0R3)				S	S	S	T	T	T	T	A, B
	0.4pF (0R4)	J	J	J	S	S	S	T	T	T	T	A, B
	0.5pF (0R5)	J	J	J	S	S	S	T	T	T	T	A, B, C
	0.6pF (0R6)	J	J	J	S	S	S	T	T	T	T	A, B, C
	0.7pF (0R7)	J	J	J	S	S	S	T	T	T	T	A, B, C
	0.8pF (0R8)	J	J	J	S	S	S	T	T	T	T	A, B, C
	0.9pF (0R9)	J	J	J	S	S	S	T	T	T	T	A, B, C
	1.0pF (1R0)	J	J	J	S	S	S	T	T	T	T	A, B, C
	1.1pF (1R1)	J	J	J	S	S	S	T	T	T	T	A, B, C
	1.2pF (1R2)	J	J	J	S	S	S	T	T	T	T	A, B, C
	1.3pF (1R3)	J	J	J	S	S	S	T	T	T	T	A, B, C
	1.4pF (1R4)	J	J	J	S	S	S	T	T	T	T	A, B, C
	1.5pF (1R5)	J	J	J	S	S	S	T	T	T	T	A, B, C
	1.6pF (1R6)	J	J	J	S	S	S	T	T	T	T	A, B, C
	1.7pF (1R7)	J	J	J	S	S	S	T	T	T	T	A, B, C
	1.8pF (1R8)	J	J	J	S	S	S	T	T	T	T	A, B, C
	1.9pF (1R9)	J	J	J	S	S	S	T	T	T	T	A, B, C
	2.0pF (2R0)	J	J	J	S	S	S	T	T	T	T	A, B, C
	2.1pF (2R1)	J	J	J	S	S	S	T	T	T	T	A, B, C
	2.2pF (2R2)	J	J	J	S	S	S	T	T	T	T	A, B, C
	2.3pF (2R3)	J	J	J	S	S	S	T	T	T	T	A, B, C
	2.4pF (2R4)	J	J	J	S	S	S	T	T	T	T	A, B, C
	2.5pF (2R5)	J	J	J	S	S	S	T	T	T	T	A, B, C
	2.6pF (2R6)	J	J	J	S	S	S	T	T	T	T	A, B, C
	2.7pF (2R7)	J	J	J	S	S	S	T	T	T	T	A, B, C
	2.8pF (2R8)	J	J	J	S	S	S	T	T	T	T	A, B, C
	2.9pF (2R9)	J	J	J	S	S	S	T	T	T	T	A, B, C
	3.0pF (3R0)	J	J	J	S	S	S	T	T	T	T	A, B, C
	3.1pF (3R1)	J	J	J	S	S	S	T	T	T	T	A, B, C
	3.2pF (3R2)	J	J	J	S	S	S	T	T	T	T	A, B, C
	3.3pF (3R3)	J	J	J	S	S	S	T	T	T	T	A, B, C
	3.4pF (3R4)	J	J	J	S	S	S	T	T	T	T	A, B, C
	3.5pF (3R5)	J	J	J	S	S	S	T	T	T	T	A, B, C
	3.6pF (3R6)	J	J	J	S	S	S	T	T	T	T	A, B, C
	3.7pF (3R7)	J	J	J	S	S	S	T	T	T	T	A, B, C
	3.8pF (3R8)	J	J	J	S	S	S	T	T	T	T	A, B, C
	3.9pF (3R9)	J	J	J	S	S	S	T	T	T	T	A, B, C
	4.0pF (4R0)	J	J	J	S	S	S	T	T	T	T	A, B, C
	4.1pF (4R1)	J	J	J	S	S	S	T	T	T	T	A, B, C
	4.2pF (4R2)	J	J	J	S	S	S	T	T	T	T	A, B, C
	4.3pF (4R3)	J	J	J	S	S	S	T	T	T	T	A, B, C
	4.4pF (4R4)	J	J	J	S	S	S	T	T	T	T	A, B, C
	4.5pF (4R5)	J	J	J	S	S	S	T	T	T	T	A, B, C
	4.6pF (4R6)	J	J	J	S	S	S	T	T	T	T	A, B, C
	4.7pF (4R7)	J	J	J	S	S	S	T	T	T	T	A, B, C
	4.8pF (4R8)	J	J	J	S	S	S	T	T	T	T	A, B, C
	4.9pF (4R9)	J	J	J	S	S	S	T	T	T	T	A, B, C
	5.0pF (5R0)	J	J	J	S	S	S	T	T	T	T	A, B, C
	5.1pF (5R1)	J	J	J	S	S	S	T	T	T	T	B, C, D
	5.2pF (5R2)	J	J	J	S	S	S	T	T	T	T	B, C, D
	5.3pF (5R3)	J	J	J	S	S	S	T	T	T	T	B, C, D
	5.4pF (5R4)	J	J	J	S	S	S	T	T	T	T	B, C, D
	5.5pF (5R5)	J	J	J	S	S	S	T	T	T	T	B, C, D
	5.6pF (5R6)	J	J	J	S	S	S	T	T	T	T	B, C, D
	5.7pF (5R7)	J	J	J	S	S	S	T	T	T	T	B, C, D
	5.8pF (5R8)	J	J	J	S	S	S	T	T	T	T	B, C, D
	5.9pF (5R9)	J	J	J	S	S	S	T	T	T	T	B, C, D
	6.0pF (6R0)	J	J	J	S	S	S	T	T	T	T	B, C, D

1. The letter in cell is expressed the symbol of product thickness.
2. For more information about products with special capacitance or other data, please contact WTC local representative.



Multilayer Ceramic Capacitors

Approval Sheet

DIELECTRIC		NP0										Tolerance
SIZE		0505			0603			0805				
RATED VOLTAGE (VDC)		50	100	250	50	100	250	50	100	250	500	
Capacitance	6.1pF (6R1)	J	J	J	S	S	S	T	T	T	T	B, C, D
	6.2pF (6R2)	J	J	J	S	S	S	T	T	T	T	B, C, D
	6.3pF (6R3)	J	J	J	S	S	S	T	T	T	T	B, C, D
	6.4pF (6R4)	J	J	J	S	S	S	T	T	T	T	B, C, D
	6.5pF (6R5)	J	J	J	S	S	S	T	T	T	T	B, C, D
	6.6pF (6R6)	J	J	J	S	S	S	T	T	T	T	B, C, D
	6.7pF (6R7)	J	J	J	S	S	S	T	T	T	T	B, C, D
	6.8pF (6R8)	J	J	J	S	S	S	T	T	T	T	B, C, D
	6.9pF (6R9)	J	J	J	S	S	S	T	T	T	T	B, C, D
	7.0pF (7R0)	J	J	J	S	S	S	T	T	T	T	B, C, D
	7.1pF (7R1)	J	J	J	S	S	S	T	T	T	T	B, C, D
	7.2pF (7R2)	J	J	J	S	S	S	T	T	T	T	B, C, D
	7.3pF (7R3)	J	J	J	S	S	S	T	T	T	T	B, C, D
	7.4pF (7R4)	J	J	J	S	S	S	T	T	T	T	B, C, D
	7.5pF (7R5)	J	J	J	S	S	S	T	T	T	T	B, C, D
	7.6pF (7R6)	J	J	J	S	S	S	T	T	T	T	B, C, D
	7.7pF (7R7)	J	J	J	S	S	S	T	T	T	T	B, C, D
	7.8pF (7R8)	J	J	J	S	S	S	T	T	T	T	B, C, D
	7.9pF (7R9)	J	J	J	S	S	S	T	T	T	T	B, C, D
	8.0pF (8R0)	J	J	J	S	S	S	T	T	T	T	B, C, D
	8.1pF (8R1)	J	J	J	S	S	S	T	T	T	T	B, C, D
	8.2pF (8R2)	J	J	J	S	S	S	T	T	T	T	B, C, D
	8.3pF (8R3)	J	J	J	S	S	S	T	T	T	T	B, C, D
	8.4pF (8R4)	J	J	J	S	S	S	T	T	T	T	B, C, D
	8.5pF (8R5)	J	J	J	S	S	S	T	T	T	T	B, C, D
	8.6pF (8R6)	J	J	J	S	S	S	T	T	T	T	B, C, D
	8.7pF (8R7)	J	J	J	S	S	S	T	T	T	T	B, C, D
	8.8pF (8R8)	J	J	J	S	S	S	T	T	T	T	B, C, D
	8.9pF (8R9)	J	J	J	S	S	S	T	T	T	T	B, C, D
	9.0pF (9R0)	J	J	J	S	S	S	T	T	T	T	B, C, D
	9.1pF (9R1)	J	J	J	S	S	S	T	T	T	T	B, C, D
	9.2pF (9R2)	J	J	J	S	S	S	T	T	T	T	B, C, D
	9.3pF (9R3)	J	J	J	S	S	S	T	T	T	T	B, C, D
	9.4pF (9R4)	J	J	J	S	S	S	T	T	T	T	B, C, D
	9.5pF (9R5)	J	J	J	S	S	S	T	T	T	T	B, C, D
	9.6pF (9R6)	J	J	J	S	S	S	T	T	T	T	B, C, D
	9.7pF (9R7)	J	J	J	S	S	S	T	T	T	T	B, C, D
	9.8pF (9R8)	J	J	J	S	S	S	T	T	T	T	B, C, D
	9.9pF (9R9)	J	J	J	S	S	S	T	T	T	T	B, C, D
	10pF (100)	J	J	J	S	S	S	T	T	T	T	F, G, J
	11pF (110)	J	J	J	S	S	S	T	T	T	T	F, G, J
	12pF (120)	J	J	J	S	S	S	T	T	T	T	F, G, J
13pF (130)	J	J	J	S	S	S	T	T	T	T	F, G, J	
15pF (150)	J	J	J	S	S	S	T	T	T	T	F, G, J	
16pF (160)	J	J	J	S	S	S	T	T	T	T	F, G, J	
18pF (180)	J	J	J	S	S	S	T	T	T	T	F, G, J	
20pF (200)	J	J	J	S	S	S	T	T	T	T	F, G, J	
22pF (220)	J	J	J	S	S	S	T	T	T	T	F, G, J	
24pF (240)	J	J	J	S	S	S	T	T	T	T	F, G, J	
27pF (270)	J	J	J	S	S	S	T	T	T	T	F, G, J	
30pF (300)	J	J	J	S	S	S	T	T	T	T	F, G, J	
33pF (330)	J	J	J	S	S	S	T	T	T	T	F, G, J	
36pF (360)	J	J	J	S	S	S	T	T	T	T	F, G, J	
39pF (390)	J	J	J	S	S	S	T	T	T	T	F, G, J	
43pF (430)	J	J	J	S	S	S	T	T	T	T	F, G, J	
47pF (470)	J	J	J	S	S	S	T	T	T	T	F, G, J	
56pF (560)	J	J	J	S	S	S	T	T	T	T	F, G, J	
68pF (680)	J	J	J	S	S	S	T	T	T	T	F, G, J	
82pF (820)	J	J	J	S	S	S	T	T	T	T	F, G, J	
100pF (101)	J	J	J	S	S	S	T	T	T	T	F, G, J	
120pF (121)				S			T	T	T		F, G, J	
150pF (151)				S			T	T	T		F, G, J	
180pF (181)				S			T	T	T		F, G, J	
220pF (221)				S			T	T	T		F, G, J	

1. The letter in cell is expressed the symbol of product thickness.
2. For more information about products with special capacitance or other data, please contact WTC local representative.



Multilayer Ceramic Capacitors

DIELECTRIC		NP0						Tolerance
SIZE		1111					Tolerance	
RATED VOLTAGE (VDC)		50	100	200	250	500		
Capacitance	1.0pF (1R0)	G	G	G	G	G	G	A, B, C
	1.1pF (1R1)	G	G	G	G	G	G	A, B, C
	1.2pF (1R2)	G	G	G	G	G	G	A, B, C
	1.3pF (1R3)	G	G	G	G	G	G	A, B, C
	1.5pF (1R5)	G	G	G	G	G	G	A, B, C
	1.6pF (1R6)	G	G	G	G	G	G	A, B, C
	1.8pF (1R8)	G	G	G	G	G	G	A, B, C
	2.0pF (2R0)	G	G	G	G	G	G	A, B, C
	2.2pF (2R2)	G	G	G	G	G	G	A, B, C
	2.4pF (2R4)	G	G	G	G	G	G	A, B, C
	2.7pF (2R7)	G	G	G	G	G	G	A, B, C
	3.0pF (3R0)	G	G	G	G	G	G	A, B, C
	3.3pF (3R3)	G	G	G	G	G	G	A, B, C
	3.6pF (3R6)	G	G	G	G	G	G	A, B, C
	3.9pF (3R9)	G	G	G	G	G	G	A, B, C
	4.0pF (4R0)	G	G	G	G	G	G	A, B, C
	4.3pF (4R3)	G	G	G	G	G	G	A, B, C
	5.0pF (5R0)	G	G	G	G	G	G	A, B, C
	5.1pF (5R1)	G	G	G	G	G	G	B, C, D
	5.6pF (5R6)	G	G	G	G	G	G	B, C, D
	6.0pF (6R0)	G	G	G	G	G	G	B, C, D
	6.8pF (6R8)	G	G	G	G	G	G	B, C, D
	7.0pF (7R0)	G	G	G	G	G	G	B, C, D
	8.0pF (8R0)	G	G	G	G	G	G	B, C, D
	8.2pF (8R2)	G	G	G	G	G	G	B, C, D
	10pF (100)	G	G	G	G	G	G	F, G, J
	12pF (120)	G	G	G	G	G	G	F, G, J
	15pF (150)	G	G	G	G	G	G	F, G, J
	18pF (180)	G	G	G	G	G	G	F, G, J
	22pF (220)	G	G	G	G	G	G	F, G, J
	27pF (270)	G	G	G	G	G	G	F, G, J
	33pF (330)	G	G	G	G	G	G	F, G, J
	39pF (390)	G	G	G	G	G	G	F, G, J
	47pF (470)	G	G	G	G	G	G	F, G, J
	56pF (560)	G	G	G	G	G	G	F, G, J
	68pF (680)	G	G	G	G	G	G	F, G, J
	82pF (820)	G	G	G	G	G	G	F, G, J
	100pF (101)	G	G	G	G	G	G	F, G, J
	120pF (121)	G	G	G	G	G	G	F, G, J
	150pF (151)	G	G	G	G	G	G	F, G, J
180pF (181)	G	G	G	G	G	G	F, G, J	
220pF (221)	G	G	G	G	G	G	F, G, J	
270pF (271)	G	G	G	G	G	G	F, G, J	
330pF (331)	G	G	G	G	G	G	F, G, J	
390pF (391)	G	G	G	G	G	G	F, G, J	
470pF (471)	G	G	G	G	G	G	F, G, J	
560pF (561)	G	G	G	G	G	G	F, G, J	
680pF (681)	G	G	G	G	G	G	F, G, J	
820pF (821)	G	G	G	G	G	G	F, G, J	
1000pF (102)	G	G	G	G	G	G	F, G, J	

1. The letter in cell is expressed the symbol of product thickness.
2. For more information about products with special capacitance or other data, please contact WTC local representative.

**9. ELECTRICAL CHARACTERISTICS**

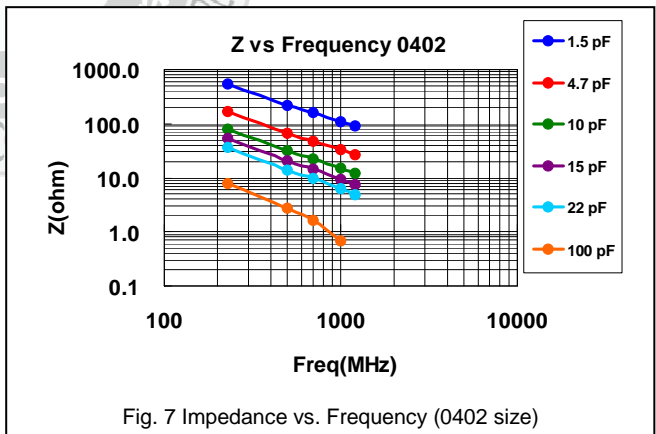
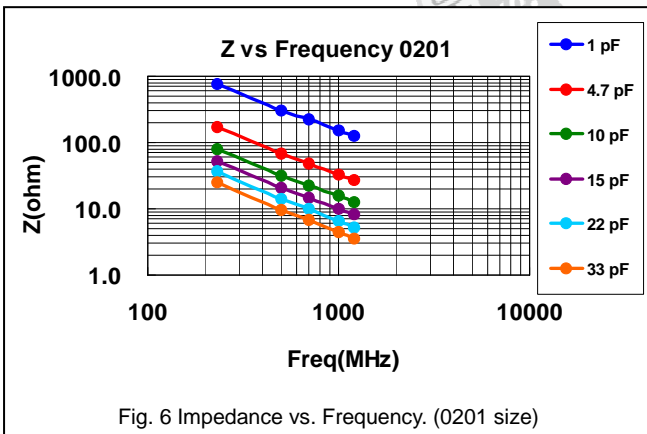
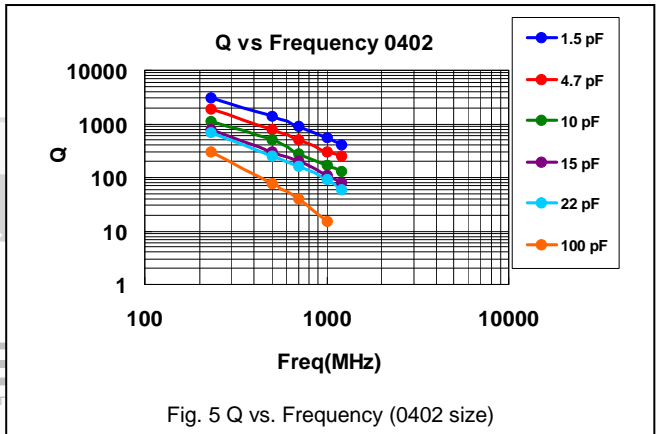
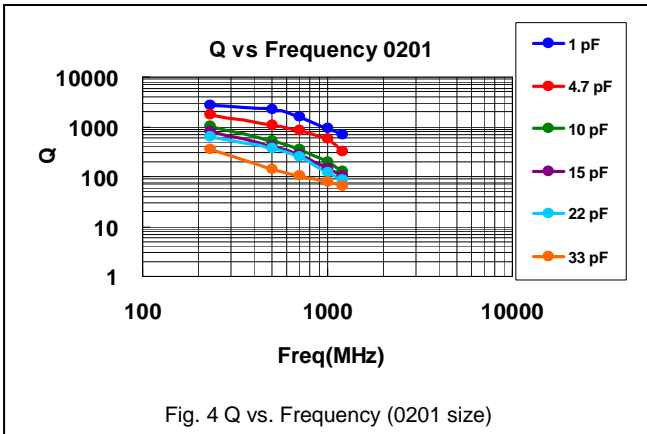
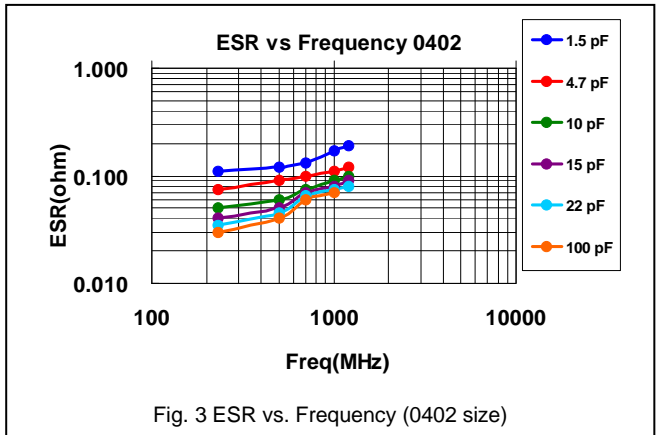

Multilayer Ceramic Capacitors



Fig. 8 ESR vs. Frequency (0603 size)



Fig. 9 ESR vs. Frequency (0805 size)



Fig. 10 Q vs. Frequency (0603 size)



Fig. 11 Q vs. Frequency (0805 size)

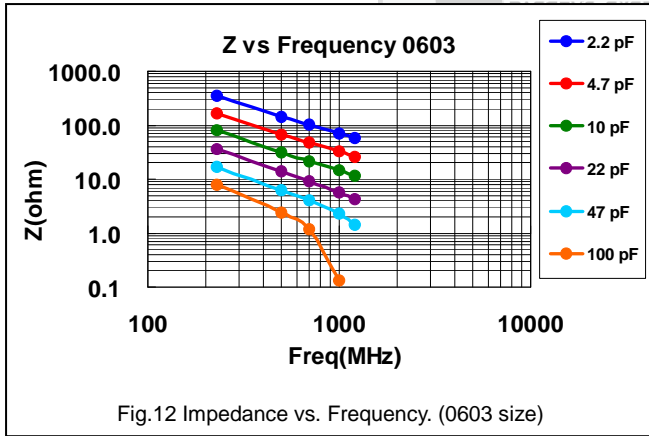

Fig.12 Impedance vs. Frequency. (0603 size)

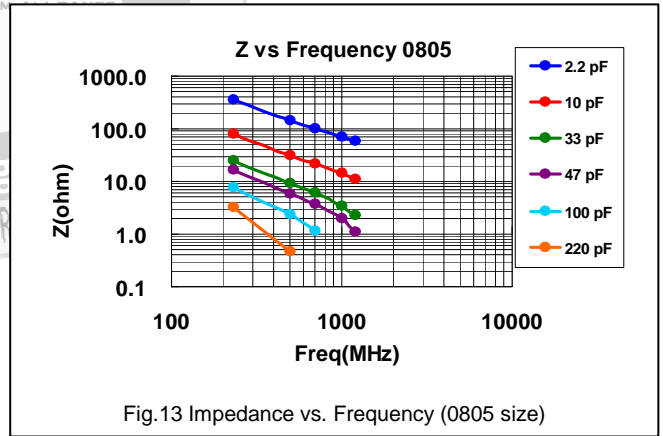
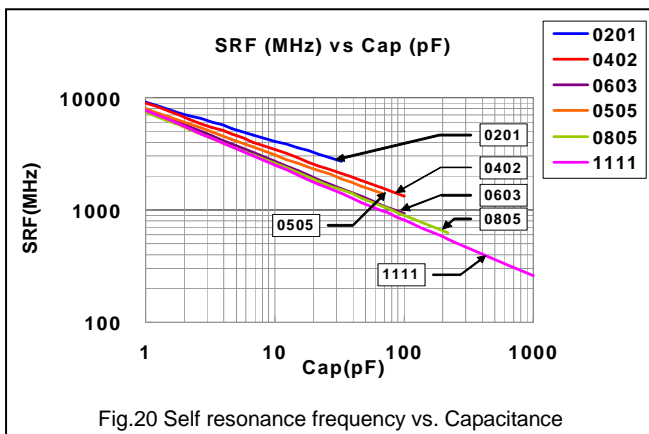

Fig.13 Impedance vs. Frequency (0805 size)

Multilayer Ceramic Capacitors



Multilayer Ceramic Capacitors

**10. RELIABILITY TEST CONDITIONS AND REQUIREMENTS**

No.	Item	Test Conditions	Requirements
1.	Visual and Mechanical		* No remarkable defect. * Dimensions to conform to individual specification sheet.
2.	Capacitance	1.0±0.2Vrms, 1MHz±10%	* Shall not exceed the limits given in the detailed spec.
3.	Q/ D.F. (Dissipation Factor)	At 25°C ambient temperature.	* 01005, 0201, 0402/25V~50V: Cap<30pF,Q≥400+20C;Cap≥30pF, Q≥1000 * 0402/100V~200V, 0603, 0805, 0505, 1111: Cap<30pF:Q≥800+20C;Cap≥30pF:Q≥1400
4.	Dielectric Strength	*To apply voltage: ≤100V : 250% of rated voltage. 200V ~ 300V : 200% of rated voltage. 500V ~ 999V : 150% of rated voltage. 1000V ~ 3000V : 120% of rated voltage. 4000V : 110% of rated voltage. *Duration: 1 to 5 sec. *Charge & discharge current less than 50mA.	* No evidence of damage or flash over during test.
5.	Insulation Resistance	≤100V : To apply rated voltage for max. 120 sec. ≥200V :To apply rated voltage (500V max.) for 60 sec.	* ≥10GΩ or RxC≥100Ω-F whichever is smaller
6.	Temperature Coefficient	With no electrical load. Operating temperature: -55~125°C at 25°C	* Capacitance change: within ±30ppm/°C;
7.	Adhesive Strength of Termination	* Pressurizing force : 01005: 1N 0201: 2N 0402 to 0603: 5N >0603: 10N * Test time: 10±1 sec.	* No remarkable damage or removal of the terminations.
8.	Vibration Resistance	* Vibration frequency: 10~55 Hz/min. * Total amplitude: 1.5mm * Test time: 6 hrs. (Two hrs each in three mutually perpendicular directions.) *Cap./DF(Q) Measurement to be made after de-aging at 150°C for 1hr then set for 24±2 hrs at room temp.	* No remarkable damage. * Cap change and Q/D.F.: To meet initial spec.
9.	Solderability	* Solder temperature: 235±5°C * Dipping time: 2±0.5 sec.	* 95% min. coverage of all metalized area.
10.	Bending Test	* The middle part of substrate shall be pressurized by means of the pressurizing rod at a rate of about 1 mm per second until the deflection becomes 1 mm and then the pressure shall be maintained for 5±1 sec. * Measurement to be made after keeping at room temp. for 24±2 hrs.	* No remarkable damage. * Cap change: within ±5.0% or ±0.5pF whichever is larger. (This capacitance change means the change of capacitance under specified flexure of substrate from the capacitance measured before the test.)
11.	Resistance to Soldering Heat	* Solder temperature: 260±5°C * Dipping time: 10±1 sec * Preheating: 120 to 150°C for 1 minute before immerse the capacitor in a eutectic solder. *Cap. / DF(Q) / I.R. Measurement to be made after de-aging at 150°C for 1hr then set for 24±2 hrs at room temp.	* No remarkable damage. * Cap change: within ±2.5% or ±0.25pF whichever is larger. * Q/D.F., I.R. and dielectric strength: To meet initial requirements. * 25% max. leaching on each edge.

Multilayer Ceramic Capacitors

No.	Item	Test Condition	Requirements																								
12.	Temperature Cycle	* Conduct the five cycles according to the temperatures and time.	* No remarkable damage. * Cap change : within $\pm 2.5\%$ or $\pm 0.25\text{pF}$ whichever is larger. * Q/D.F., I.R. and dielectric strength: To meet initial requirements.																								
		<table border="1"> <thead> <tr> <th>Step</th> <th>Temp. (°C)</th> <th>Time (min.)</th> </tr> </thead> <tbody> <tr> <td>1</td> <td>Min. operating temp. +0/-3</td> <td>30<math>\pm</math>3</td> </tr> <tr> <td>2</td> <td>Room temp.</td> <td>2~3</td> </tr> <tr> <td>3</td> <td>Max. operating temp. +3/-0</td> <td>30<math>\pm</math>3</td> </tr> <tr> <td>4</td> <td>Room temp.</td> <td>2~3</td> </tr> </tbody> </table> <p>* Cap. / DF(Q) / I.R. Measurement to be made after de-aging at 150°C for 1hr then set for 24<math>\pm</math>2 hrs at room temp.</p>	Step	Temp. (°C)	Time (min.)	1	Min. operating temp. +0/-3	30 $\pm$ 3	2	Room temp.	2~3	3	Max. operating temp. +3/-0	30 $\pm$ 3	4	Room temp.	2~3										
Step	Temp. (°C)	Time (min.)																									
1	Min. operating temp. +0/-3	30 $\pm$ 3																									
2	Room temp.	2~3																									
3	Max. operating temp. +3/-0	30 $\pm$ 3																									
4	Room temp.	2~3																									
13.	Humidity (Damp Heat) Steady State	* Test temp.: 40 $\pm$ 2°C * Humidity: 90~95% RH * Test time: 500+24/-0hrs. * Cap. / DF(Q) / I.R. Measurement to be made after de-aging at 150°C for 1hr then set for 24 $\pm$ 2 hrs at room temp.	* No remarkable damage. * Cap change: within $\pm 5.0\%$ or $\pm 0.5\text{pF}$ whichever is larger. * Q/D.F. value: Cap $\geq$ 30pF, Q $\geq$ 350; 10pF $\leq$ Cap<30pF, Q $\geq$ 275+2.5C Cap<10pF; Q $\geq$ 200+10C * I.R.: $\geq 1\text{G}\Omega$ .																								
14.	Humidity (Damp Heat) Load	* Test temp.: 40 $\pm$ 2°C * Humidity: 90~95%RH * Test time: 500+24/-0 hrs. * To apply voltage : rated voltage (MAX. 500V) * Cap. / DF(Q) / I.R. Measurement to be made after de-aging at 150°C for 1hr then set for 24 $\pm$ 2 hrs at room temp.	* No remarkable damage. * Cap change: within $\pm 7.5\%$ or $\pm 0.75\text{pF}$ whichever is larger. * Q/D.F. value: Cap $\geq$ 30pF, Q $\geq$ 200; Cap<30pF, Q $\geq$ 100+10/3C * I.R.: $\geq 500\text{M}\Omega$ .																								
15.	High Temperature Load (Endurance)	* Test temp.: 125 $\pm$ 3°C * To apply voltage: (1) 10V $\leq$ Ur<500V: 200% of rated voltage. (2) $\leq 6.3\text{V}$ or 500V: 150% of rated voltage. (3) Ur $\geq 630\text{V}$ : 120% of rated voltage. * Test time: 1000+24/-0 hrs. * Cap. / DF(Q) / I.R. Measurement to be made after de-aging at 150°C for 1hr then set for 24 $\pm$ 2 hrs at room temp.	* No remarkable damage. * Cap change: within $\pm 3.0\%$ or $\pm 0.3\text{pF}$ whichever is larger. * Q/D.F. value: Cap $\geq$ 30pF, Q $\geq$ 350 10pF $\leq$ Cap<30pF, Q $\geq$ 275+2.5C Cap<10pF, Q $\geq$ 200+10C * I.R.: $\geq 1\text{G}\Omega$ .																								
16.	ESR	The ESR should be measured at room temperature and tested at frequency 1 $\pm$ 0.1 GHz.	<table border="1"> <thead> <tr> <th colspan="2">01005</th> <th colspan="2">0505</th> </tr> </thead> <tbody> <tr> <td>0.2pF<math>\leq</math>Cap<math>\leq</math>1pF:<math>&lt;</math> 700m<math>\Omega</math>/pF</td> <td>0.4pF<math>\leq</math>Cap<math>\leq</math>1.0pF: <math>&lt;</math> 1500m<math>\Omega</math></td> <td></td> <td></td> </tr> <tr> <td>1pF&lt;Cap<math>\leq</math>2pF:<math>&lt;</math> 600m<math>\Omega</math></td> <td>1.0pF<math>\leq</math>Cap<math>\leq</math>10pF: <math>&lt;</math> 250m<math>\Omega</math></td> <td></td> <td></td> </tr> <tr> <td>2pF&lt;Cap<math>\leq</math>5pF:<math>&lt;</math> 500m<math>\Omega</math></td> <td>10pF<math>\leq</math>Cap<math>\leq</math>100pF: <math>&lt;</math> 200m<math>\Omega</math></td> <td></td> <td></td> </tr> <tr> <td>5pF&lt;Cap<math>\leq</math>10pF:<math>&lt;</math> 300m<math>\Omega</math></td> <td></td> <td></td> <td></td> </tr> <tr> <td>10pF&lt;Cap<math>\leq</math>22pF:<math>&lt;</math> 350m<math>\Omega</math></td> <td></td> <td></td> <td></td> </tr> </tbody> </table>	01005		0505		0.2pF $\leq$ Cap $\leq$ 1pF: $<$ 700m $\Omega$ /pF	0.4pF $\leq$ Cap $\leq$ 1.0pF: $<$ 1500m $\Omega$			1pF<Cap $\leq$ 2pF: $<$ 600m $\Omega$	1.0pF $\leq$ Cap $\leq$ 10pF: $<$ 250m $\Omega$			2pF<Cap $\leq$ 5pF: $<$ 500m $\Omega$	10pF $\leq$ Cap $\leq$ 100pF: $<$ 200m $\Omega$			5pF<Cap $\leq$ 10pF: $<$ 300m $\Omega$				10pF<Cap $\leq$ 22pF: $<$ 350m $\Omega$			
			01005		0505																						
			0.2pF $\leq$ Cap $\leq$ 1pF: $<$ 700m $\Omega$ /pF	0.4pF $\leq$ Cap $\leq$ 1.0pF: $<$ 1500m $\Omega$																							
			1pF<Cap $\leq$ 2pF: $<$ 600m $\Omega$	1.0pF $\leq$ Cap $\leq$ 10pF: $<$ 250m $\Omega$																							
			2pF<Cap $\leq$ 5pF: $<$ 500m $\Omega$	10pF $\leq$ Cap $\leq$ 100pF: $<$ 200m $\Omega$																							
			5pF<Cap $\leq$ 10pF: $<$ 300m $\Omega$																								
			10pF<Cap $\leq$ 22pF: $<$ 350m $\Omega$																								
			<table border="1"> <thead> <tr> <th colspan="2">0201</th> <th colspan="2">0402</th> </tr> </thead> <tbody> <tr> <td>0.1pF<math>\leq</math>Cap<math>\leq</math>1pF:<math>&lt;</math> 350m<math>\Omega</math>/pF</td> <td>0.1pF<math>\leq</math>Cap<math>\leq</math>1pF:<math>&lt;</math> 350m<math>\Omega</math>/pF</td> <td></td> <td></td> </tr> <tr> <td>1pF&lt;Cap<math>\leq</math>5pF:<math>&lt;</math> 300m<math>\Omega</math></td> <td>1pF&lt;Cap<math>\leq</math>5pF:<math>&lt;</math> 300m<math>\Omega</math></td> <td></td> <td></td> </tr> <tr> <td>5pF&lt;Cap<math>\leq</math>22pF:<math>&lt;</math> 250m<math>\Omega</math></td> <td>5pF&lt;Cap<math>\leq</math>100pF:<math>&lt;</math> 250m<math>\Omega</math></td> <td></td> <td></td> </tr> </tbody> </table>	0201		0402		0.1pF $\leq$ Cap $\leq$ 1pF: $<$ 350m $\Omega$ /pF	0.1pF $\leq$ Cap $\leq$ 1pF: $<$ 350m $\Omega$ /pF			1pF<Cap $\leq$ 5pF: $<$ 300m $\Omega$	1pF<Cap $\leq$ 5pF: $<$ 300m $\Omega$			5pF<Cap $\leq$ 22pF: $<$ 250m $\Omega$	5pF<Cap $\leq$ 100pF: $<$ 250m $\Omega$										
			0201		0402																						
			0.1pF $\leq$ Cap $\leq$ 1pF: $<$ 350m $\Omega$ /pF	0.1pF $\leq$ Cap $\leq$ 1pF: $<$ 350m $\Omega$ /pF																							
1pF<Cap $\leq$ 5pF: $<$ 300m $\Omega$	1pF<Cap $\leq$ 5pF: $<$ 300m $\Omega$																										
5pF<Cap $\leq$ 22pF: $<$ 250m $\Omega$	5pF<Cap $\leq$ 100pF: $<$ 250m $\Omega$																										
<table border="1"> <thead> <tr> <th colspan="2">0603</th> <th colspan="2">0805</th> </tr> </thead> <tbody> <tr> <td>0.3pF<math>\leq</math>Cap<math>\leq</math>1pF:<math>&lt;</math> 1500m<math>\Omega</math></td> <td>0.3pF<math>\leq</math>Cap<math>\leq</math>1pF: <math>&lt;</math> 1500m<math>\Omega</math></td> <td></td> <td></td> </tr> <tr> <td>1pF&lt;Cap<math>\leq</math>10pF:<math>&lt;</math> 250m<math>\Omega</math></td> <td>1pF&lt;Cap<math>\leq</math>10pF: <math>&lt;</math> 250m<math>\Omega</math></td> <td></td> <td></td> </tr> <tr> <td>10pF&lt;Cap<math>\leq</math>220pF:<math>&lt;</math> 200m<math>\Omega</math></td> <td>Cap&gt;10pF: <math>&lt;</math> 200m<math>\Omega</math></td> <td></td> <td></td> </tr> </tbody> </table>	0603		0805		0.3pF $\leq$ Cap $\leq$ 1pF: $<$ 1500m $\Omega$	0.3pF $\leq$ Cap $\leq$ 1pF: $<$ 1500m $\Omega$			1pF<Cap $\leq$ 10pF: $<$ 250m $\Omega$	1pF<Cap $\leq$ 10pF: $<$ 250m $\Omega$			10pF<Cap $\leq$ 220pF: $<$ 200m $\Omega$	Cap>10pF: $<$ 200m $\Omega$													
0603		0805																									
0.3pF $\leq$ Cap $\leq$ 1pF: $<$ 1500m $\Omega$	0.3pF $\leq$ Cap $\leq$ 1pF: $<$ 1500m $\Omega$																										
1pF<Cap $\leq$ 10pF: $<$ 250m $\Omega$	1pF<Cap $\leq$ 10pF: $<$ 250m $\Omega$																										
10pF<Cap $\leq$ 220pF: $<$ 200m $\Omega$	Cap>10pF: $<$ 200m $\Omega$																										
The ESR should be measured at room temperature and tested at frequency 500 $\pm$ 50 MHz.	0201, 22pF $\leq$ Cap $\leq$ 33pF: $<$ 300m $\Omega$																										

Multilayer Ceramic Capacitors

**APPENDIXES**

▣ Tape & reel dimensions

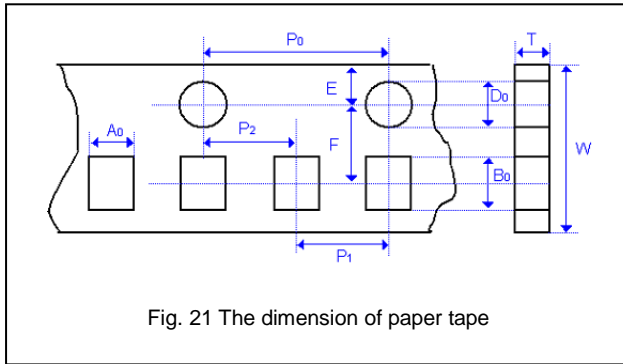

Fig. 21 The dimension of paper tape

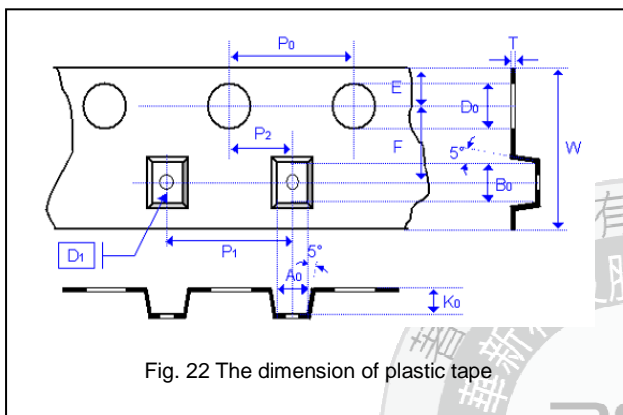

Fig. 22 The dimension of plastic tape

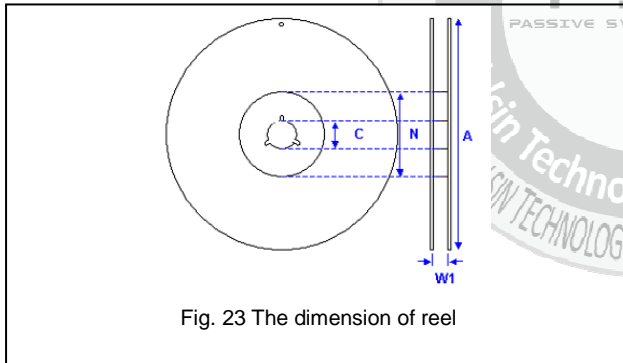
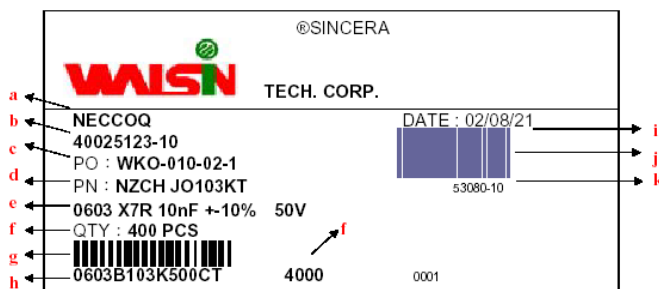

Fig. 23 The dimension of reel

Size	01005	0201	0402	0505	0603	0805	1111
Thickness	V	L	N	J	S	T	G
A <sub>0</sub>	0.25 +/-0.05	0.40 +/-0.10	0.70 +/-0.20	< 1.90	1.05 +/-0.30	1.50 +/-0.20	< 3.05
B <sub>0</sub>	0.45 +/-0.05	0.70 +/-0.10	1.20 +/-0.20	< 1.90	1.80 +/-0.30	2.30 +/-0.20	< 3.80
T	≤ 0.50	≤ 0.55	≤ 0.80	0.23 +/-0.1	≤ 1.20	≤ 1.20	0.23 +/-0.1
K <sub>0</sub>	-	-	-	< 1.50	-	-	< 2.50
W	8.00 +/-0.30	8.00 +/-0.30	8.00 +/-0.30	8.00 +/-0.30	8.00 +/-0.30	8.00 +/-0.30	8.00 +/-0.30
P <sub>0</sub>	4.00 +/-0.10	4.00 +/-0.10	4.00 +/-0.10	4.00 +/-0.10	4.00 +/-0.10	4.00 +/-0.10	4.00 +/-0.10
10xP <sub>0</sub>	40.00 +/-0.10	40.00 +/-0.10	40.00 +/-0.10	40.00 +/-0.20	40.00 +/-0.20	40.00 +/-0.20	40.00 +/-0.20
P <sub>1</sub>	2.00 +/-0.05	2.00 +/-0.05	2.00 +/-0.05	4.00 +/-0.10	4.00 +/-0.10	4.00 +/-0.10	4.00 +/-0.10
P <sub>2</sub>	2.00 +/-0.05	2.00 +/-0.05	2.00 +/-0.05	2.00 +/-0.05	2.00 +/-0.05	2.00 +/-0.05	2.00 +/-0.05
D <sub>0</sub>	1.50 +0.1/-0	1.50 +0.1/-0	1.50 +0.1/-0	1.50 +0.1/-0	1.50 +0.1/-0	1.50 +0.1/-0	1.50 +0.1/-0
D <sub>1</sub>	-	-	-	1.00 +/-0.10	-	-	1.00 +/-0.10
E	1.75 +/-0.10	1.75 +/-0.10	1.75 +/-0.10	1.75 +/-0.10	1.75 +/-0.10	1.75 +/-0.10	1.75 +/-0.10
F	3.50 +/-0.05	3.50 +/-0.05	3.50 +/-0.05	3.50 +/-0.05	3.50 +/-0.05	3.50 +/-0.05	3.50 +/-0.05

Size	01005, 0201, 0402, 0505, 0603, 0805, 1111	
Reel size	7"	13"
C	13.0+0.5/-0.2	13.0+0.5/-0.2
W <sub>1</sub>	8.4+1.5/-0	8.4+1.5/-0
A	178.0±1.0	330.0±1.0
N	60.0+1.0/-0	100±1.0

▣ Example of customer label



\*Customized label is available upon request

- a. Customer name
- b. WTC order series and item number
- c. Customer P/O
- d. Customer P/N
- e. Description of product
- f. Quantity
- g. Bar code including quantity & WTC P/N or customer
- h. WTC P/N
- i. Shipping date
- j. Order bar code including series and item numbers
- k. Serial number of label



**Multilayer Ceramic Capacitors**

**Constructions**

No.	Name	NPO
①	Ceramic material	Hi-Q dielectric ceramic
②	Inner electrode	Cu
③	Termination	Inner layer
④		Middle layer
⑤		Outer layer
		Sn (Matt)

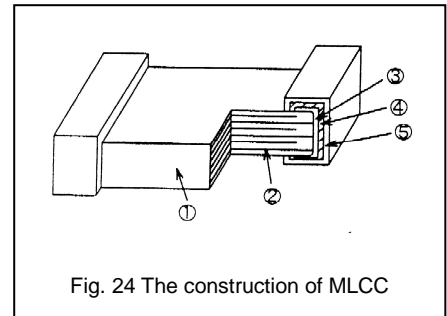

Fig. 24 The construction of MLCC

**Storage and handling conditions**

- (1) To store products at 5 to 40°C ambient temperature and 20 to 70% related humidity conditions.
- (2) The product is recommended to be used within one year after shipment. Check solderability in case of shelf life extension is needed.

Cautions:

- a. The corrosive gas reacts on the terminal electrodes of capacitors, and results in the poor solderability. Do not store the capacitors in the ambience of corrosive gas (e.g., hydrogen sulfide, sulfur dioxide, chlorine, ammonia gas etc.)
- b. In corrosive atmosphere, solderability might be degraded, and silver migration might occur to cause low reliability.
- c. Due to the dewing by rapid humidity change, or the photochemical change of the terminal electrode by direct sunlight, the solderability and electrical performance may deteriorate. Do not store capacitors under direct sunlight or dewing condition. To store products on the shelf and avoid exposure to moisture.

**Recommended soldering conditions**

The lead-free termination MLCCs are not only to be used on SMT against lead-free solder paste, but also suitable against lead-containing solder paste. If the optimized solder joint is requested, increasing soldering time, temperature and concentration of N<sub>2</sub> within oven are recommended.

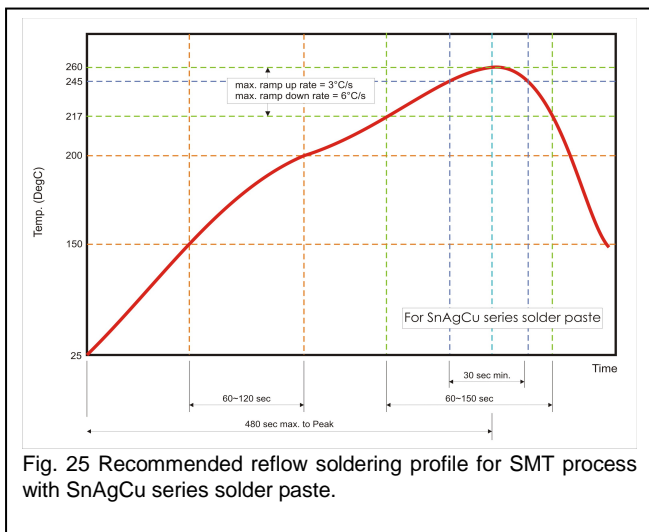

Fig. 25 Recommended reflow soldering profile for SMT process with SnAgCu series solder paste.

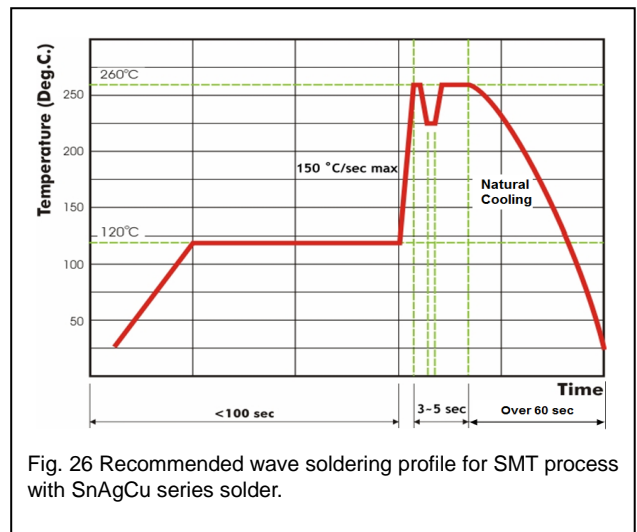

Fig. 26 Recommended wave soldering profile for SMT process with SnAgCu series solder.

Компания «Океан Электроники» предлагает заключение долгосрочных отношений при поставках импортных электронных компонентов на взаимовыгодных условиях!

Наши преимущества:

- Поставка оригинальных импортных электронных компонентов напрямую с производств Америки, Европы и Азии, а так же с крупнейших складов мира;
- Широкая линейка поставок активных и пассивных импортных электронных компонентов (более 30 млн. наименований);
- Поставка сложных, дефицитных, либо снятых с производства позиций;
- Оперативные сроки поставки под заказ (от 5 рабочих дней);
- Экспресс доставка в любую точку России;
- Помощь Конструкторского Отдела и консультации квалифицированных инженеров;
- Техническая поддержка проекта, помощь в подборе аналогов, поставка прототипов;
- Поставка электронных компонентов под контролем ВП;
- Система менеджмента качества сертифицирована по Международному стандарту ISO 9001;
- При необходимости вся продукция военного и аэрокосмического назначения проходит испытания и сертификацию в лаборатории (по согласованию с заказчиком);
- Поставка специализированных компонентов военного и аэрокосмического уровня качества (Xilinx, Altera, Analog Devices, Intersil, Interpoint, Microsemi, Actel, Aeroflex, Peregrine, VPT, Syfer, Eurofarad, Texas Instruments, MS Kennedy, Miteq, Cobham, E2V, MA-COM, Hittite, Mini-Circuits, General Dynamics и др.);

Компания «Океан Электроники» является официальным дистрибьютором и эксклюзивным представителем в России одного из крупнейших производителей разъемов военного и аэрокосмического назначения «JONHON», а так же официальным дистрибьютором и эксклюзивным представителем в России производителя высокотехнологичных и надежных решений для передачи СВЧ сигналов «FORSTAR».



## JONHON

«JONHON» (основан в 1970 г.)

Разъемы специального, военного и аэрокосмического назначения:

(Применяются в военной, авиационной, аэрокосмической, морской, железнодорожной, горно- и нефтедобывающей отраслях промышленности)

«FORSTAR» (основан в 1998 г.)

ВЧ соединители, коаксиальные кабели, кабельные сборки и микроволновые компоненты:

(Применяются в телекоммуникациях гражданского и специального назначения, в средствах связи, РЛС, а так же военной, авиационной и аэрокосмической отраслях промышленности).



Телефон: 8 (812) 309-75-97 (многоканальный)

Факс: 8 (812) 320-03-32

Электронная почта: [ocean@oceanchips.ru](mailto:ocean@oceanchips.ru)

Web: <http://oceanchips.ru/>

Адрес: 198099, г. Санкт-Петербург, ул. Калинина, д. 2, корп. 4, лит. А