

96 x 64 Graphic OLED

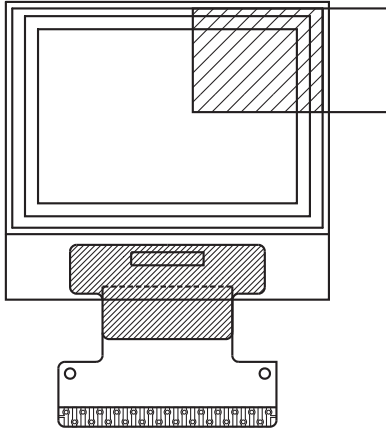

FEATURES

- Type: graphic
- Display format: 96 x 64 dots
- Built-in controller: SSD1305Z
- Duty cycle: 1/64
- +3 V power supply
- Interface: 6800, 8080, SPI, I²C
- With polarizer
- Material categorization: for definitions of compliance please see www.vishay.com/doc?99912

**RoHS
COMPLIANT**

MECHANICAL DATA		
ITEM	STANDARD VALUE	UNIT
Module dimension	24.9 x 22.95 x 1.65	mm
Viewing area	21.953 x 15.424	
Active area	19.946 x 13.418	
Dot size	0.186 x 0.188	
Dot pitch	0.208 x 0.210	
Mounting hole	n/a	

ABSOLUTE MAXIMUM RATINGS				
ITEM	SYMBOL	STANDARD VALUE		UNIT
		MIN.	MAX.	
Supply voltage for logic ⁽¹⁾⁽²⁾	V _{DD}	-0.3	4	V
Supply voltage for display ⁽¹⁾⁽²⁾	V _{CC}	0	15	
Operating temperature	T _{OP}	-40	+80	°C
Storage temperature	T _{STG}	-40	+80	

Notes

- ⁽¹⁾ All the above voltages are on the basis of “V_{SS} = 0 V”
- ⁽²⁾ When this module is used beyond the above absolute maximum ratings, permanent breakage of the module may occur. Also, for normal operations, it is desirable to use this module under the conditions according to “Electrical Characteristics”. If this module is used beyond these conditions, malfunctioning of the module can occur and the reliability of the module may deteriorate

ELECTRICAL CHARACTERISTICS						
ITEM	SYMBOL	CONDITION	STANDARD VALUE			UNIT
			MIN.	TYP.	MAX.	
Supply voltage for logic	V _{DD}	-	2.8	3.0	3.3	V
Supply voltage for display	V _{CC}	-	11	12	13	
Input high voltage	V _{IH}	-	0.8 V _{DD}	-	V _{DDI/O}	
Input low voltage	V _{IL}	-	0	-	0.2 V _{DD}	
Output high voltage	V _{OH}	-	0.9 V _{DD}	-	V _{DDI/O}	
Output low voltage	V _{OL}	-	0	-	0.1 V _{DD}	
50 % check board operating current	I _{CC}	V _{CC} = 12 V	5.8	6.0	7.5	mA

OPTIONS				
EMITTING COLOR				
YELLOW	GREEN	RED	BLUE	WHITE
Yes	-	-	-	-



INTERFACE PIN FUNCTION																		
PIN NO.	SYMBOL	I/O	FUNCTION															
1	NC (GND)	-	Reserved pin (supporting pin) The supporting pins can reduce the influences from stresses on the function pins. These pins must be connected to external ground															
2	V _{CC}	P	Power supply for OLED panel This is the most positive voltage supply pin of the chip. It must be supplied externally															
3	V _{SS}	P	Ground of logic circuit This is a ground pin. It also acts as a reference for the logic pins. It must be connected to external ground															
4	V _{DD}	P	Power supply for logic circuit This is a voltage supply pin. It must be connected to external source															
5	V _{DDI/O}	P	Power supply for interface logic level. It should be match with MCU interface voltage level. V _{DDI/O} must always be equal or lower than V _{DD}															
6	BS1	I	Communicating protocol select. These pins are MCU interface selection input. See the following table: <table border="1" style="margin-left: 20px;"> <thead> <tr> <th></th> <th>68XX-parallel</th> <th>80XX-parallel</th> <th>Serial</th> <th>I²C</th> </tr> </thead> <tbody> <tr> <td>BS1</td> <td>0</td> <td>1</td> <td>0</td> <td>1</td> </tr> <tr> <td>BS2</td> <td>1</td> <td>1</td> <td>0</td> <td>0</td> </tr> </tbody> </table>		68XX-parallel	80XX-parallel	Serial	I ² C	BS1	0	1	0	1	BS2	1	1	0	0
	68XX-parallel			80XX-parallel	Serial	I ² C												
BS1	0			1	0	1												
BS2	1	1	0	0														
7	BS2																	
8	CS#	I	Chip select This pin is the chip select input. The chip is enabled for MCU communication only when CS# is pulled low															
9	RES#	I	Power reset for controller and driver This pin is reset signal input. When the pin is low, initialization of the chip is executed															
10	D / C#	I	Data / command control This pin is data / command control pin. When the pin is pulled high, the input at D7 to D0 is treated as display data. When the pin is pulled low, the input at D7 to D0 will be transferred to the command register. For detail relationship to MCU interface signals, please refer to the timing characteristics diagrams. When the pin is pulled high and serial interface mode is selected, the data at SDIN is treated as data. When it is pulled low, the data at SDIN will be transferred to the command register. In I ² C mode, this pin acts as SA0 for slave address selection															
11	R / W#	I	Read / write selector write This pin is MCU interface input. When interfacing to a 68XX-series microprocessor, this pin will be used as read / write (R / W#) selection input. Pull this pin to "high" for read mode and pull it to "low" for write mode. When 80XX interface mode is selected, this pin will be the write (WR#) input. Data write operation is initiated when this pin is pulled low and the CS# is pulled low															
12	E / RD#	I	Read / write enable or read This pin is MCU interface input. When interfacing to a 68XX-series microprocessor, this pin will be used as the enable (E) signal. Read / write operation is initiated when this pin is pulled high and the CS# is pulled low. When connecting to an 80XX-microprocessor, this pin receives the read (RD#) signal. Data read operation is initiated when this pin is pulled low and CS# is pulled low															
13	D0 to D7	I/O	Host data in put / output bus These pins are 8-bit bi-directional data bus to be connected to the microprocessor's data bus. When serial mode is selected, D1 will be the serial data input SDIN and D0 will be the serial clock input SCLK. When I ² C mode is selected, D2 and D1 should be tied together and serve as SDA _{out} and SDA _{in} in application and D0 is the serial clock input SCL															
14																		
15																		
16																		
17																		
18																		
19																		
20																		
21	I _{REF}	I	Current reference for brightness adjustment This pin is segment current reference pin. A resistor should be connected between this pin and V _{SS} . Set the current lower than 10 μA															
22	V _{COMH}	O	Voltage output high level for COM signal This pin is the input pin for the voltage output high level for COM signals. A capacitor should be connected between this pin and V _{SS}															
23	V _{CC}	P	Power supply for OLED panel This is the most positive voltage supply pin of the chip. It must be supplied externally															
24	V _{LSS}	P	Ground of analog circuit. This is an analog ground pin. It should be connected to V _{SS} externally															
25	NC (GND)	-	Reserved pin (supporting pin) The supporting pins can reduce the influences from stresses on the function pins. These pins must be connected to external ground															

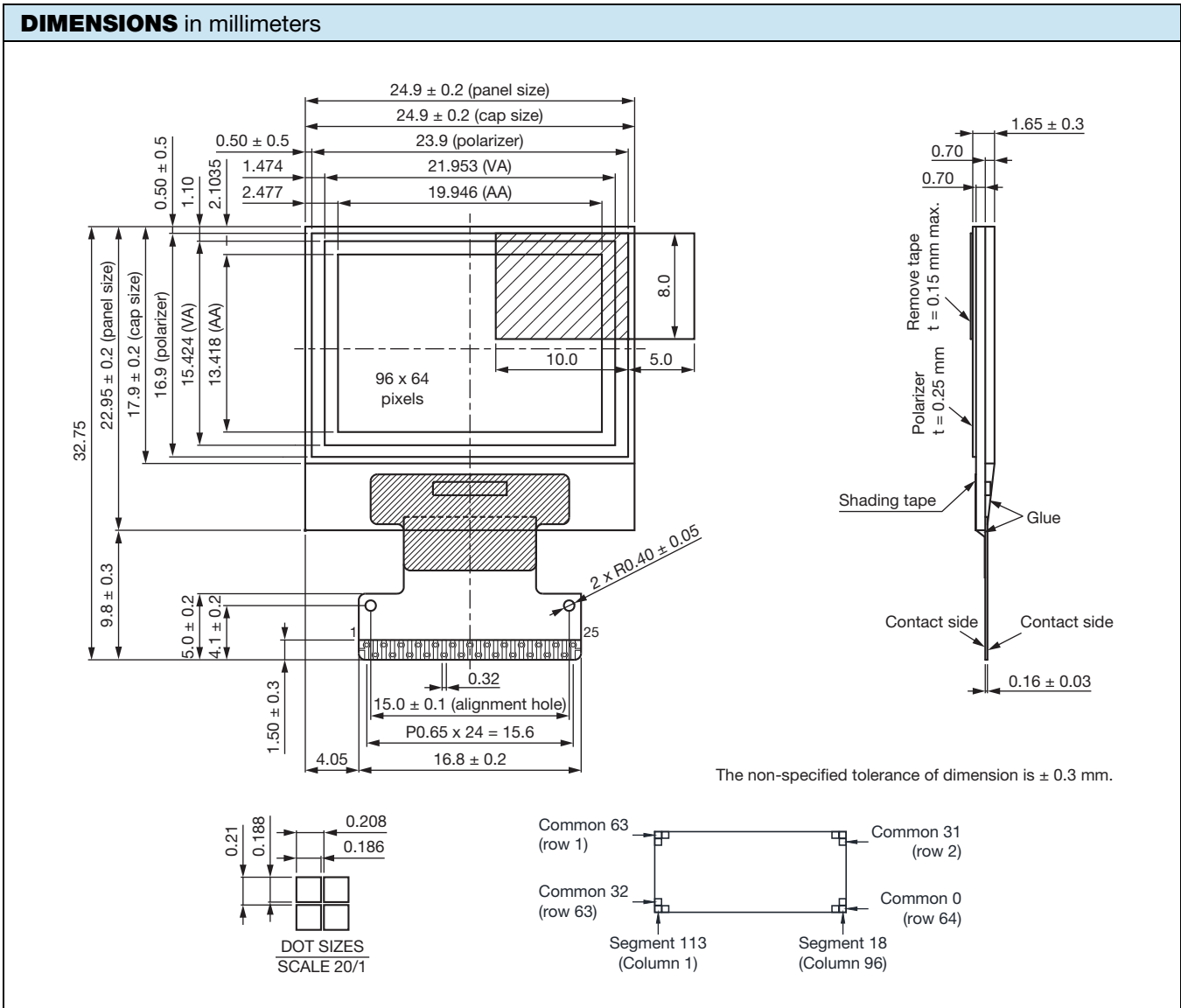



MODULE CLASSIFICATION INFORMATION

OLED	-	096	O	064	A	-	L	P	P	3	N	0	0	000
1		2	3	4	5	6	7	8	9	10	11	12	13	
1	Brand	Vishay Intertechnology, Inc.												
2	Horizontal format	96 columns												
3	Display type	F: COG type, with frame H: graphic type N: character type O: COG type Y: tab type												
4	Vertical format	64 lines												
5	Serials code	A												
6	Emitting color	A: amber B: blue C: full color G: green L: yellow R: red S: sky blue W: white X: yellow / sky blue (dual color) Y: yellow green												
7	Polarizer	N: without polarizer P: with polarizer												
8	Display mode	A: active matrix P: passive matrix												
9	Driver voltage	3: 3.0 V to 3.3 V 5: 5.0 V												
10	Touch panel	N: without touch panel T: with touch panel												
11	Products type	0: standard 1: sunlight readable 2: transparent OLED (TOLED) 3: flexible OLED 4: OLED for lighting												
12	Product grades	0: standard (A level) 2: B level 3: C level 4: high class (AA level) 5: customer offerings												
13	Serial number	Application serial number (000 to ZZZ)												

GENERAL SPECIFICATIONS		
ITEM	DIMENSION	UNIT
Number of characters	96 x 64 dots	
Module dimension	24.9 x 22.95 x 1.65	mm
View area	21.953 x 15.424	mm
Active area	19.946 x 13.418	mm
Dot size	0.186 x 0.188	mm
Dot pitch	0.208 x 0.210	mm
Panel type	OLED, yellow	
Duty	1/64	
IC	SDD1305Z	

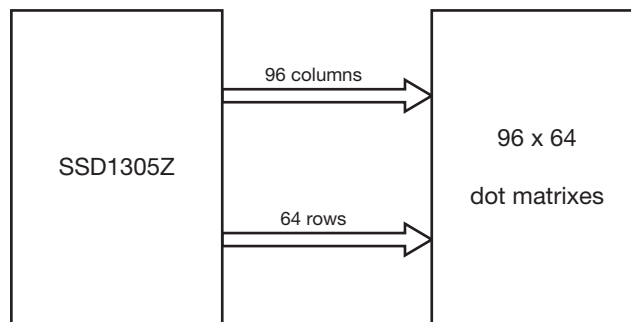
FUNCTION BLOCK DIAGRAM

Notes

- V_{CC} supplied externally
- For more information, please refer to Application Note provided by Vishay

OPTICAL CHARACTERISTICS						
ITEM	SYMBOL	CONDITION	MIN.	TYP.	MAX.	UNIT
View angle	(V) θ		160	-	-	deg
	(H) ϕ		160	-	-	
Contrast ratio	CR	Dark	2000 : 1	-	-	-
Response time	t_{rise}		-	10	-	μs
	t_{fall}		-	10	-	μs
Display with 50 % check board brightness			80	100	-	cd/m ²
CIE _x (yellow)	(CIE1931)		0.45	0.47	0.49	
CIE _y (yellow)	(CIE1931)		0.48	0.50	0.52	



OLED LIFETIME			
ITEM	CONDITIONS	MIN.	TYP.
Operating life time	T _A = 25 °C, initial 50 % check board brightness typical value	50 000 h	-

Notes

- Life time is defined the amount of time when the luminance has decayed to < 50 % of the initial value
- This analysis method uses life data obtained under accelerated conditions to extrapolate an estimated probability density function (PDF) for the product under normal use conditions
- Screen saving mode will extend OLED lifetime



RELIABILITY		
ENVIRONMENTAL TEST		
TEST ITEM	CONTENT OF TEST	TEST CONDITION
High temperature storage	Endurance test applying the high storage temperature for a long time	80 °C, 240 h
Low temperature storage	Endurance test applying the low storage temperature for a long time	-40 °C, 240 h
High temperature operation	Endurance test applying the electric stress (voltage and current) and the thermal stress to the element for a long time	80 °C, 240 h
Low temperature operation	Endurance test applying the electric stress under low temperature for a long time	-40 °C, 240 h
High temperature / humidity storage	Endurance test applying the high temperature and high humidity storage for a long time	60 °C, 90 % RH, 240 h
Temperature cycle	Endurance test applying the low and high temperature cycle 	-40 °C / 80 °C, 100 cycles
MECHANICAL TEST		
Vibration test	Endurance test applying the vibration during transportation and using	10 Hz to 22 Hz for 1.5 mm peak-to-peak, 22 Hz to 500 Hz for 1.5 g, total 0.5 h
Shock test	Constructional and mechanical endurance test applying the shock during transportation	50 g half sin wave 11 ms, 3 times of each direction
Atmospheric pressure test	Endurance test applying the atmospheric pressure during transportation by air	115 mbar, 40 h
OTHERS		
Static electricity test	Endurance test applying the electric stress to the terminal	$V_S = \pm 600$ V (contact), ± 800 V (air), $R_S = 330 \Omega$, $C_S = 150$ pF, 10 times

Note

- Supply voltage for OLED system = operating voltage at 25 °C

TEST AND MEASUREMENT CONDITIONS

1. All measurements shall not be started until the specimens attain to temperature stability. After the completion of the described reliability test, the samples were left at room temperature for 2 hours prior to conducting the failure test at 23 °C ± 5 °C, 55 % ± 15 % RH
2. All-pixels-on is used as operation test pattern
3. The degradation of polarizer are ignored for high temperature storage, high temperature / humidity storage, temperature cycle

EVALUATION CRITERIA

4. The function test is OK
5. No observable defects
6. Luminance: > 50 % of initial value
7. Current consumption: within ± 50 % of initial value

APPENDIX: RESIDUE IMAGE

Because the pixels are lighted in different time, the luminance of active pixels may reduce or differ from inactive pixels. Therefore, the residue image will occur. To avoid the residue image, every pixel needs to be lighted up uniformly.



INSPECTION SPECIFICATION			
NO.	ITEM	CRITERION	AQL
08	Backlight elements	8.1 Illumination source flickers when lit	0.65
		8.2 Spots or scratched that appear when lit must be judged. Using OLED spot, lines and contamination standards	2.5
		8.3 Backlight does not light or color wrong	0.65
09	Bezel	9.1 Bezel may not have rust, be deformed or have fingerprints, stains or other contamination	2.5
		9.2 Bezel must comply with job specifications	0.65
10	PCB, COB	10.1 COB seal may not have pinholes larger than 0.2 mm or contamination	2.5
		10.2 COB seal surface may not have pinholes through to the IC	2.5
		10.3 The height of the COB should not exceed the height indicated in the assembly diagram	0.65
		10.4 There may not be more than 2 mm of sealant outside the seal area on the PCB. And there should be no more than three places	2.5
		10.5 No oxidation or contamination PCB terminals	2.5
		10.6 Parts on PCB must be the same as on the production characteristic chart. There should be no wrong parts, missing parts or excess parts	0.65
		10.7 The jumper on the PCB should conform to the product characteristic chart	0.65
		10.8 If solder gets on bezel tab pads, OLED pad, zebra pad or screw hold pad, make sure it is smoothed down	2.5
11	Soldering	11.1 No un-melted solder paste may be present on the PCB	2.5
		11.2 No cold solder joints, missing solder connections, oxidation or icicle	2.5
		11.3 No residue or solder balls on PCB	2.5
		11.4 No short circuits in components on PCB	0.65
12	General appearance	12.1 No oxidation, contamination, curves or, bends on interface pin (OLB) of TCP	2.5
		12.2 No cracks on interface pin (OLB) of TCP	0.65
		12.3 No contamination, solder residue or solder balls on product	2.5
		12.4 The IC on the TCP may not be damaged, circuits	2.5
		12.5 The uppermost edge of the protective strip on the interface pin must be present or look as if it cause the interface pin to sever	2.5
		12.6 The residual rosin or tin oil of soldering (component or chip component) is not burned into brown or black color	2.5
		12.7 Sealant on top of the ITO circuit has not hardened	2.5
		12.8 Pin type must match type in specification sheet	0.65
		12.9 OLED pin loose or missing pins	0.65
		12.10 Product packaging must the same as specified on packaging specification sheet	0.65
		12.11 Product dimension and structure must conform to product specification sheet	0.65



CHECK ITEM	CLASSIFICATION	CRITERIA
No display	Major	
Missing line	Major	
Pixel short	Major	
Darker short	Major	
Wrong display	Major	
Un-uniform $B/A \times 100 \% < 70 \%$ $A/C \times 100 \% < 70 \%$	Major	

PRECAUTIONS IN USE OF OLED MODULES

MODULES

1. Avoid applying excessive shocks to module or making any alterations or modifications to it
2. Do not make extra holes on the printed circuit board, modify its shape or change the components of OLED display module
3. Do not disassemble the OLED display module
4. Do not operate it above the absolute maximum rating
5. Do not drop, bend or twist OLED display module
6. Soldering: only to the I/O terminals
7. Storage: please storage in anti-static electricity container and clean environment
8. It is pretty common to use “screen saver” to extend the lifetime and do not use fix information for long time in real application
9. Do not use fixed information in OLED panel for long time, that will extend “screen burn” effect time
10. Vishay has the right to change the passive components, including R2 and R3 adjust resistors. (Resistors, capacitors, and other passive components will have different appearance and color caused by the different supplier)
11. Vishay have the right to change the PCB Rev. (In order to satisfy the supplying stability, management optimization, and the best product performance... etc, under the premise of not affecting the electrical characteristics and external dimensions, Vishay have the right to modify the version)

HANDLING PRECAUTIONS

1. Since the display panel is being made of glass, do not apply mechanical impacts such as dropping from a high position
2. If the display panel is broken by some accident and the internal organic substance leaks out, be careful not to inhale nor lick the organic substance
3. If pressure is applied to the display surface or its neighborhood of the OLED display module, the cell structure may be damaged and be careful not to apply pressure to these sections
4. The polarizer covering the surface of the OLED display module is soft and easily scratched. Please be careful when handling the OLED display module
5. When the surface of the polarizer of the OLED display module has soil, clean the surface. It takes advantage of by using following adhesion tape
 - Scotch mending tape no. 810 or an equivalent

Never try to breathe upon the soiled surface nor wipe the surface using cloth containing solvent such as ethyl alcohol, since the surface of the polarizer will become cloudy. Also, pay attention that the following liquid and solvent may spoil the polarizer:

 - Water
 - Ketone
 - Aromatic solvents
6. Hold OLED display module very carefully when placing OLED display module into the system housing. Do not apply excessive stress or pressure to OLED display module. And, do not over bend the film with electrode pattern layouts. These stresses will influence the display performance. Also, secure sufficient rigidity for the outer cases



7. Do not apply stress to the LSI chips and the surrounding molded sections
8. Do not disassemble nor modify the OLED display module
9. Do not apply input signals while the logic power is off



10. Pay sufficient attention to the working environments when handing OLED display modules to prevent occurrence of element breakage accidents by static electricity
 - Be sure to make human body grounding when handling OLED display modules
 - Be sure to ground tools to use or assembly such as soldering irons
 - To suppress generation of static electricity, avoid carrying out assembly work under dry environments
 - Protective film is being applied to the surface of the display panel of the OLED display module. Be careful since static electricity may be generated when exfoliating the protective film
11. Protection film is being applied to the surface of the display panel and removes the protection film before assembling it. At this time, if the OLED display module has been stored for a long period of time, residue adhesive material of the protection film may remain on the surface of the display panel after removed of the film. In such case, remove the residue material by the method introduced in the above no. 5
12. If electric current is applied when the OLED display module is being dewed or when it is placed under high humidity environments, the electrodes may be corroded and be careful to avoid the above

STORAGE PRECAUTIONS

1. When storing OLED display modules, put them in static electricity preventive bags avoiding exposure to direct sun light nor to lights of fluorescent lamps and, also, avoiding high temperature and high humidity environment or low temperature (less than 0 °C) environments. We recommend you to store these modules in the packaged state when they were shipped from Vishay. At that time, be careful not to let water drops adhere to the packages or bags nor let dewing occur with them
2. If electric current is applied when water drops are adhering to the surface of the OLED display module, when the OLED display module is being dewed or when it is placed under high humidity environments, the electrodes may be corroded and be careful about the above

DESIGNING PRECAUTIONS

1. The absolute maximum ratings are the ratings which cannot be exceeded for OLED display module, and if these values are exceeded, panel damage may be happen
2. To prevent occurrence of malfunctioning by noise, pay attention to satisfy the V_{IL} and V_{IH} specifications and, at the same time, to make the signal line cable as short as possible
3. We recommend you to install excess current preventive unit (fuses, etc.) to the power circuit (V_{DD}) (recommend value: 0.5 A)
4. Pay sufficient attention to avoid occurrence of mutual noise interference with the neighboring devices
5. As for EMI, take necessary measures on the equipment side basically
6. When fastening the OLED display module, fasten the external plastic housing section
7. If power supply to the OLED display module is forcibly shut down by such errors as taking out the main battery while the OLED display panel is in operation, we cannot guarantee the quality of this OLED display module
 - Connection (contact) to any other potential than the above may lead to rupture of the IC

PRECAUTIONS WHEN DISPOSING OF THE OLED DISPLAY MODULES

1. Request the qualified companies to handle industrial wastes when disposing of the OLED display modules. Or, when burning them, be sure to observe the environmental and hygienic laws and regulations

OTHER PRECAUTIONS

1. When an OLED display module is operated for a long of time with fixed pattern may remain as an after image or slight contrast deviation may occur. Nonetheless, if the operation is interrupted and left unused for a while, normal state can be restored. Also, there will be no problem in the reliability of the module
2. To protect OLED display modules from performance drops by static electricity rapture, etc., do not touch the following sections whenever possible while handling the OLED display modules
 - Pins and electrodes
 - Pattern layouts such as the TCP and FPC
3. With this OLED display module, the OLED driver is being exposed. Generally speaking, semiconductor elements change their characteristics when light is radiated according to the principle of the solar battery. Consequently, if this OLED driver is exposed to light, malfunctioning may occur
 - Design the product and installation method so that the OLED driver may be shielded from light in actual usage
 - Design the product and installation method so that the OLED driver may be shielded from light during the inspection processes

4. Although this OLED display module stores the operation state data by the commands and the indication data, when excessive external noise, etc. enters into the module, the internal status may be changed. It therefore is necessary to take appropriate measures to suppress noise generation or to protect from influences of noise on the system design
5. We recommend you to construct its software to make periodical refreshment of the operation statuses (re-setting of the commands and re-transference of the display data) to cope with catastrophic noise
6. Resistors, capacitors, and other passive components will have different appearance and color caused by the different supplier
7. Our company will has the right to upgrade and modify the product function
8. The limitation of FPC bending

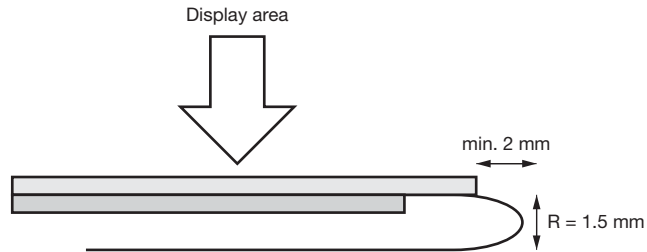



Disclaimer

ALL PRODUCT, PRODUCT SPECIFICATIONS AND DATA ARE SUBJECT TO CHANGE WITHOUT NOTICE TO IMPROVE RELIABILITY, FUNCTION OR DESIGN OR OTHERWISE.

Vishay Intertechnology, Inc., its affiliates, agents, and employees, and all persons acting on its or their behalf (collectively, "Vishay"), disclaim any and all liability for any errors, inaccuracies or incompleteness contained in any datasheet or in any other disclosure relating to any product.

Vishay makes no warranty, representation or guarantee regarding the suitability of the products for any particular purpose or the continuing production of any product. To the maximum extent permitted by applicable law, Vishay disclaims (i) any and all liability arising out of the application or use of any product, (ii) any and all liability, including without limitation special, consequential or incidental damages, and (iii) any and all implied warranties, including warranties of fitness for particular purpose, non-infringement and merchantability.

Statements regarding the suitability of products for certain types of applications are based on Vishay's knowledge of typical requirements that are often placed on Vishay products in generic applications. Such statements are not binding statements about the suitability of products for a particular application. It is the customer's responsibility to validate that a particular product with the properties described in the product specification is suitable for use in a particular application. Parameters provided in datasheets and / or specifications may vary in different applications and performance may vary over time. All operating parameters, including typical parameters, must be validated for each customer application by the customer's technical experts. Product specifications do not expand or otherwise modify Vishay's terms and conditions of purchase, including but not limited to the warranty expressed therein.

Except as expressly indicated in writing, Vishay products are not designed for use in medical, life-saving, or life-sustaining applications or for any other application in which the failure of the Vishay product could result in personal injury or death. Customers using or selling Vishay products not expressly indicated for use in such applications do so at their own risk. Please contact authorized Vishay personnel to obtain written terms and conditions regarding products designed for such applications.

No license, express or implied, by estoppel or otherwise, to any intellectual property rights is granted by this document or by any conduct of Vishay. Product names and markings noted herein may be trademarks of their respective owners.

Компания «Океан Электроники» предлагает заключение долгосрочных отношений при поставках импортных электронных компонентов на взаимовыгодных условиях!

Наши преимущества:

- Поставка оригинальных импортных электронных компонентов напрямую с производств Америки, Европы и Азии, а так же с крупнейших складов мира;
- Широкая линейка поставок активных и пассивных импортных электронных компонентов (более 30 млн. наименований);
- Поставка сложных, дефицитных, либо снятых с производства позиций;
- Оперативные сроки поставки под заказ (от 5 рабочих дней);
- Экспресс доставка в любую точку России;
- Помощь Конструкторского Отдела и консультации квалифицированных инженеров;
- Техническая поддержка проекта, помощь в подборе аналогов, поставка прототипов;
- Поставка электронных компонентов под контролем ВП;
- Система менеджмента качества сертифицирована по Международному стандарту ISO 9001;
- При необходимости вся продукция военного и аэрокосмического назначения проходит испытания и сертификацию в лаборатории (по согласованию с заказчиком);
- Поставка специализированных компонентов военного и аэрокосмического уровня качества (Xilinx, Altera, Analog Devices, Intersil, Interpoint, Microsemi, Actel, Aeroflex, Peregrine, VPT, Syfer, Eurofarad, Texas Instruments, MS Kennedy, Miteq, Cobham, E2V, MA-COM, Hittite, Mini-Circuits, General Dynamics и др.);

Компания «Океан Электроники» является официальным дистрибьютором и эксклюзивным представителем в России одного из крупнейших производителей разъемов военного и аэрокосмического назначения «JONHON», а так же официальным дистрибьютором и эксклюзивным представителем в России производителя высокотехнологичных и надежных решений для передачи СВЧ сигналов «FORSTAR».



JONHON

«JONHON» (основан в 1970 г.)

Разъемы специального, военного и аэрокосмического назначения:

(Применяются в военной, авиационной, аэрокосмической, морской, железнодорожной, горно- и нефтедобывающей отраслях промышленности)

«FORSTAR» (основан в 1998 г.)

ВЧ соединители, коаксиальные кабели,
кабельные сборки и микроволновые компоненты:

(Применяются в телекоммуникациях гражданского и специального назначения, в средствах связи, РЛС, а так же военной, авиационной и аэрокосмической отраслях промышленности).



Телефон: 8 (812) 309-75-97 (многоканальный)

Факс: 8 (812) 320-03-32

Электронная почта: ocean@oceanchips.ru

Web: <http://oceanchips.ru/>

Адрес: 198099, г. Санкт-Петербург, ул. Калинина, д. 2, корп. 4, лит. А