

### FEATURES

#### High speed

–3 dB bandwidth: 190 MHz,  $G = +5$

Slew rate: 820 V/ $\mu$ s,  $R_{LOAD} = 50 \Omega$

#### Wide output swing

20.4 V p-p differential,  $R_{LOAD}$  of 100  $\Omega$  from 12 V supply

#### High output current

#### Low distortion

–95 dBc typical at 1 MHz,  $V_{OUT} = 2$  V p-p,  $G = +5$ ,  $R_{LOAD} = 50 \Omega$

–69 dBc typical at 10 MHz,  $V_{OUT} = 2$  V p-p,  $G = +5$ ,  $R_{LOAD} = 50 \Omega$

#### Power management and shutdown

Control inputs CMOS level compatible

Shutdown quiescent current 0.65 mA/amplifier

Adjustable low quiescent current: 3.9 mA to 7.6 mA per amp

### APPLICATIONS

Home networking line drivers

Twisted pair line drivers

Power line communications

Video line drivers

ARB line drivers

I/Q channel amplifiers

### GENERAL DESCRIPTION

The ADA4310-1 is comprised of two high speed, current feedback operational amplifiers. The high output current, high bandwidth, and fast slew rate make it an excellent choice for broadband applications requiring high linearity performance while driving low impedance loads.

The ADA4310-1 incorporates a power management function that provides shutdown capabilities and/or the ability to optimize the amplifiers quiescent current. The CMOS-compatible, power-down control pins (PD1 and PD0) enable the ADA4310-1 to operate in four different modes: full power, medium power, low power, and complete power down. In the power-down mode, quiescent current drops to only 0.65 mA/amplifier, while the amplifier output goes to a high impedance state.

### PIN CONFIGURATIONS

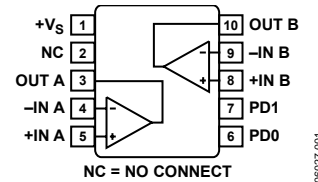

Figure 1. Thermally Enhanced, 10-Lead MINI\_SO\_EP

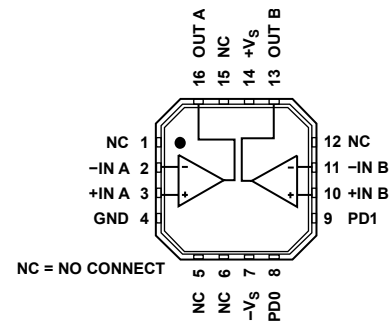

Figure 2. Thermally Enhanced, 4 mm  $\times$  4 mm 16-Lead LFCSP\_VQ

The ADA4310-1 is available in a thermally enhanced, 10-lead MSOP with an exposed paddle for improved thermal conduction and in a thermally enhanced, 4 mm  $\times$  4 mm 16-lead LFCSP. The ADA4310-1 is rated to work in the extended industrial temperature range of  $-40^{\circ}\text{C}$  to  $+85^{\circ}\text{C}$ .

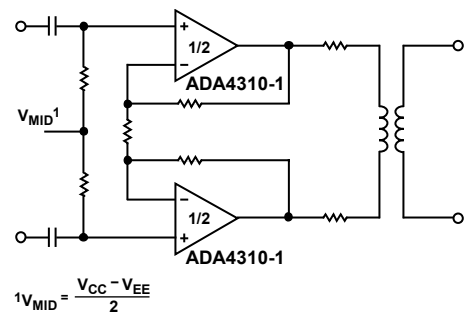

Figure 3. Typical PLC Driver Application

#### Rev. 0

Information furnished by Analog Devices is believed to be accurate and reliable. However, no responsibility is assumed by Analog Devices for its use, nor for any infringements of patents or other rights of third parties that may result from its use. Specifications subject to change without notice. No license is granted by implication or otherwise under any patent or patent rights of Analog Devices. Trademarks and registered trademarks are the property of their respective owners.

## TABLE OF CONTENTS

Features .....	1	Theory of Operation .....	10
Applications.....	1	Application Information.....	11
Pin Configurations .....	1	Feedback Resistor Selection.....	11
General Description .....	1	Power Control Modes of Operation .....	11
Revision History .....	2	Exposed Thermal Pad Connections .....	11
Specifications.....	3	Power Line Application .....	11
Absolute Maximum Ratings.....	5	Board Layout.....	12
Thermal Resistance .....	5	Power Supply Bypassing.....	12
ESD Caution.....	5	Outline Dimensions .....	13
Pin Configurations and Function Descriptions .....	6	Ordering Guide .....	13
Typical Performance Characteristics .....	7		

## REVISION HISTORY

10/06—Revision 0: Initial Version

## SPECIFICATIONS

$V_S = 12\text{ V}, \pm 6\text{ V}$  (@  $T_A = 25^\circ\text{C}$ ,  $G = +5$ ,  $R_L = 100\ \Omega$ , unless otherwise noted).

Table 1.

Parameter	Test Conditions/Comments	Min	Typ	Max	Unit
<b>DYNAMIC PERFORMANCE</b>					
-3 dB Bandwidth	$G = +5, V_{OUT} = 0.1\text{ V p-p}, PD1 = 0, PD0 = 0$		190		MHz
	$PD1 = 0, PD0 = 1$		140		MHz
	$PD1 = 1, PD0 = 0$		100		MHz
Slew Rate	$G = +5, V_{OUT} = 2\text{ V p-p}, R_{LOAD} = 50\ \Omega, PD1 = 0, PD0 = 0$		820		V/ $\mu\text{s}$
	$PD1 = 0, PD0 = 1$		790		V/ $\mu\text{s}$
	$PD1 = 1, PD0 = 0$		750		V/ $\mu\text{s}$
<b>NOISE/DISTORTION PERFORMANCE</b>					
Distortion (Worst Harmonic)	$f_C = 1\text{ MHz}, V_{OUT} = 2\text{ V p-p}, R_{LOAD} = 50\ \Omega$				
	$PD1 = 0, PD0 = 0$		-95		dBc
	$PD1 = 0, PD0 = 1$		-88		dBc
	$PD1 = 1, PD0 = 0$		-77		dBc
	$f_C = 10\text{ MHz}, V_{OUT} = 2\text{ V p-p}, R_{LOAD} = 50\ \Omega$				
	$PD1 = 0, PD0 = 0$		-69		dBc
	$PD1 = 0, PD0 = 1$		-57		dBc
	$PD1 = 1, PD0 = 0$		-47		dBc
	$f_C = 20\text{ MHz}, V_{OUT} = 2\text{ V p-p}, R_{LOAD} = 50\ \Omega$				
$PD1 = 0, PD0 = 0$		-50		dBc	
$PD1 = 0, PD0 = 1$		-42		dBc	
$PD1 = 1, PD0 = 0$		-35		dBc	
Input Voltage Noise	$f = 100\text{ kHz}$		2.85		nV/ $\sqrt{\text{Hz}}$
Input Current Noise	$f = 100\text{ kHz}$		21.8		pA/ $\sqrt{\text{Hz}}$
<b>DC PERFORMANCE</b>					
Input Offset Voltage			1		mV
Input Bias Current					
Noninverting Input			-2		$\mu\text{A}$
Inverting Input			6		$\mu\text{A}$
Open-Loop Transimpedance					
	$R_{LOAD} = 50\ \Omega$		14		M $\Omega$
	$R_{LOAD} = 100\ \Omega$		35		M $\Omega$
Common-Mode Rejection			-62		dB
<b>INPUT CHARACTERISTICS</b>					
Input Resistance	$f < 100\text{ kHz}$		500		k $\Omega$
<b>OUTPUT CHARACTERISTICS</b>					
Single-Ended +Swing	$R_{LOAD} = 50\ \Omega$		+5.08		V <sub>p</sub>
Single-Ended -Swing	$R_{LOAD} = 50\ \Omega$		-5.12		V <sub>p</sub>
Single-Ended +Swing	$R_{LOAD} = 100\ \Omega$		+5.14		V <sub>p</sub>
Single-Ended -Swing	$R_{LOAD} = 100\ \Omega$		-5.17		V <sub>p</sub>
Differential Swing	$R_{LOAD} = 100\ \Omega$		20.4		V p-p
<b>POWER SUPPLY</b>					
Operating Range (Dual Supply)		$\pm 2.5$		$\pm 6$	V
Operating Range (Single Supply)		+5		+12	V
Supply Current	$PD1 = 0, PD0 = 0$		7.6		mA/amp
	$PD1 = 0, PD0 = 1$		5.6		mA/amp
	$PD1 = 1, PD0 = 0$		3.9		mA/amp
	$PD1 = 1, PD0 = 1$		0.65		mA/amp

# ADA4310-1

Parameter	Test Conditions/Comments	Min	Typ	Max	Unit
POWER DOWN PINS					
PD1, PD0 Threshold	Referenced to GND		1.5		V
PD1, PD0 = 0 Pin Bias Current	PD1 or PD0 = 0 V		-0.2		$\mu$ A
PD1, PD0 = 1 Pin Bias Current	PD1 or PD0 = 3 V		70		$\mu$ A
Enable/Disable Time				0.04/2	$\mu$ s
Power Supply Rejection Ratio	Positive/Negative		-70/-60		dB

## ABSOLUTE MAXIMUM RATINGS

Table 2.

Parameter	Rating
Supply Voltage	
10-Lead MINI_SO_EP	12 V
16-Lead LFCSP_VQ	±6V
Power Dissipation	$(T_{JMAX} - T_A)/\theta_{JA}$
Storage Temperature Range	-65°C to +125°C
Operating Temperature Range	-40°C to +85°C
Lead Temperature (Soldering 10 sec)	300°C
Junction Temperature	150°C

Stresses above those listed under Absolute Maximum Ratings may cause permanent damage to the device. This is a stress rating only; functional operation of the device at these or any other conditions above those indicated in the operational section of this specification is not implied. Exposure to absolute maximum rating conditions for extended periods may affect device reliability.

### THERMAL RESISTANCE

$\theta_{JA}$  is specified for the worst-case conditions, that is,  $\theta_{JA}$  is specified for device soldered in circuit board for surface-mount packages.

Table 3.

Package Type	$\theta_{JA}$	Unit
10-Lead MINI_SO_EP	44	°C/W
16-Lead LFCSP_VQ	63	°C/W

### Maximum Power Dissipation

The maximum safe power dissipation for the ADA4310-1 is limited by the associated rise in junction temperature ( $T_J$ ) on the die. At approximately 150°C, which is the glass transition temperature, the plastic changes its properties. Even temporarily exceeding this temperature limit can change the stresses that the package exerts on the die, permanently shifting the parametric performance of the amplifiers. Exceeding a junction temperature of 150°C for an extended period can result in changes in silicon devices, potentially causing degradation or loss of functionality.

Figure 4 shows the maximum safe power dissipation in the package vs. the ambient temperature for the 10-lead MINI\_SO\_EP (44°C/W) and for the 16-lead LFCSP\_VQ (63°C/W) on a JEDEC standard 4-layer board.  $\theta_{JA}$  values are approximations.

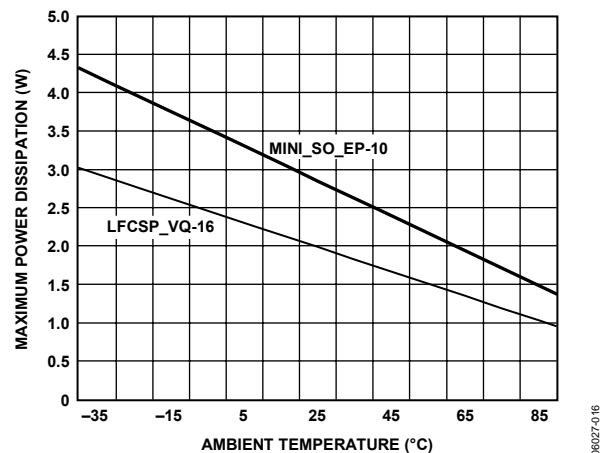

Figure 4. Maximum Power Dissipation vs. Temperature for a 4-Layer Board

### ESD CAUTION

ESD (electrostatic discharge) sensitive device. Electrostatic charges as high as 4000 V readily accumulate on the human body and test equipment and can discharge without detection. Although this product features proprietary ESD protection circuitry, permanent damage may occur on devices subjected to high energy electrostatic discharges. Therefore, proper ESD precautions are recommended to avoid performance degradation or loss of functionality.



## PIN CONFIGURATIONS AND FUNCTION DESCRIPTIONS

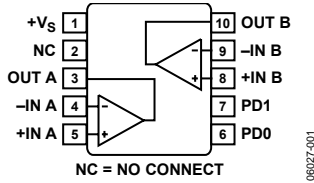

Figure 5. 10-Lead MSOP Pin Configuration

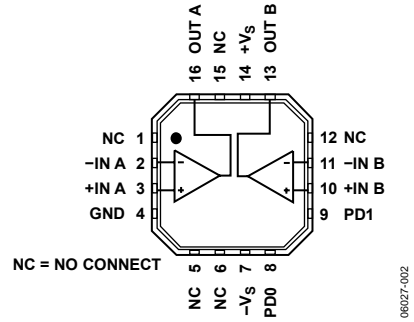

Figure 6. 16-Lead LFCSP Pin Configuration

Table 4. 10-Lead MSOP Pin Function Description

Pin No.	Mnemonic	Description
1	+Vs	Positive Power Supply Input
2	NC	No Connection
3	OUT A	Amplifier A Output
4	-IN A	Amplifier A Inverting Input
5	+IN A	Amplifier A Noninverting Input
6	PD0	Power Dissipation Control
7	PD1	Power Dissipation Control
8	+IN B	Amplifier B Noninverting Input
9	-IN B	Amplifier B Inverting Input
10	OUT B	Amplifier B Output
11 (Exposed Paddle)	GND	Ground (Electrical Connection Required)

Table 5. 16-Lead LFCSP Pin Function Description

Pin No.	Mnemonic	Description
1, 5, 6, 12, 15	NC	No Connection
2	-IN A	Amplifier A Inverting Input
3	+IN A	Amplifier A Noninverting Input
4	GND	Ground
7	-Vs	Negative Power Supply Input
8	PD0	Power Dissipation Control
9	PD1	Power Dissipation Control
10	+IN B	Amplifier B Noninverting Input
11	-IN B	Amplifier B Inverting Input
13	OUT B	Amplifier B Output
14	+Vs	Positive Power Supply Input
16	OUT A	Amplifier A Output
17 (Exposed Paddle)	GND	Ground

# TYPICAL PERFORMANCE CHARACTERISTICS

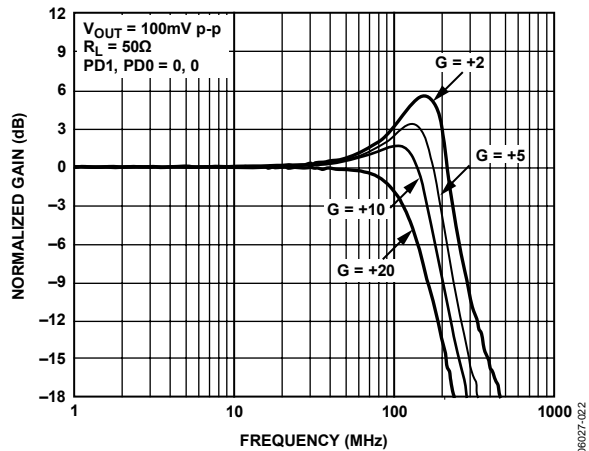

Figure 7. Small Signal Frequency Response for Various Closed-Loop Gains

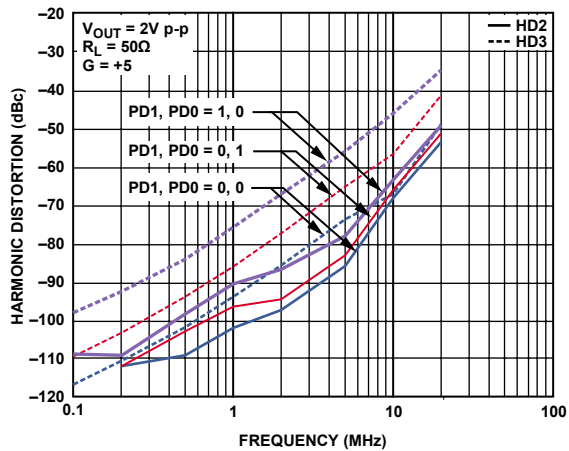

Figure 10. Harmonic Distortion vs. Frequency

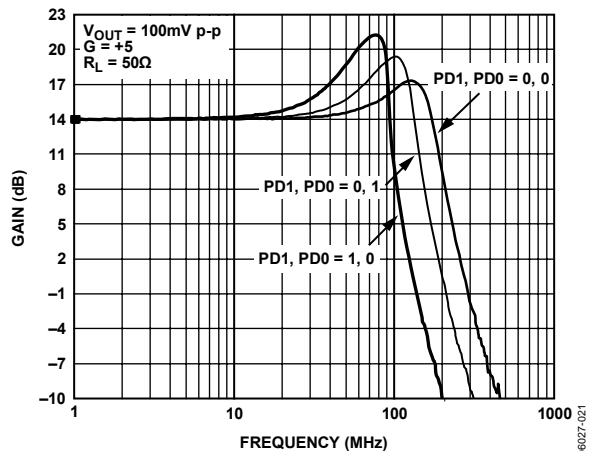

Figure 8. Small Signal Frequency Response for Various Modes

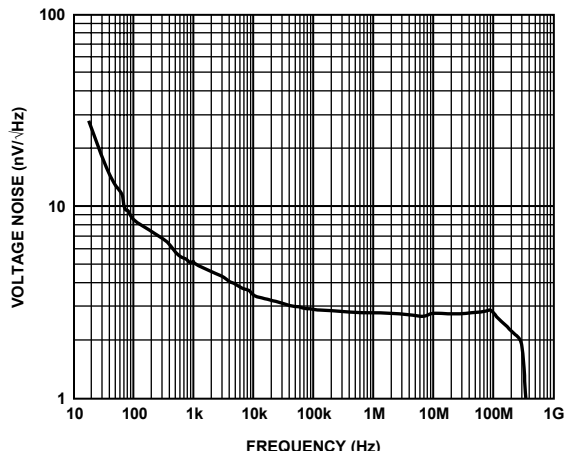

Figure 11. Voltage Noise vs. Frequency

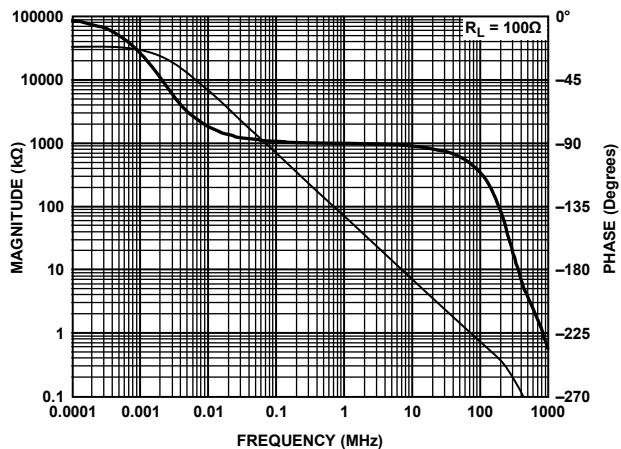

Figure 9. Open-Loop Transimpedance Gain and Phase vs. Frequency

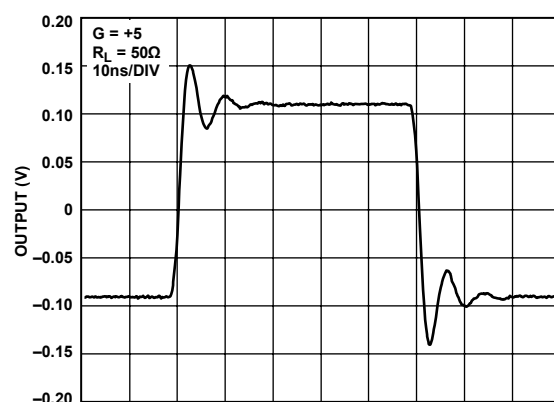

Figure 12. Small Signal Transient Response

# ADA4310-1

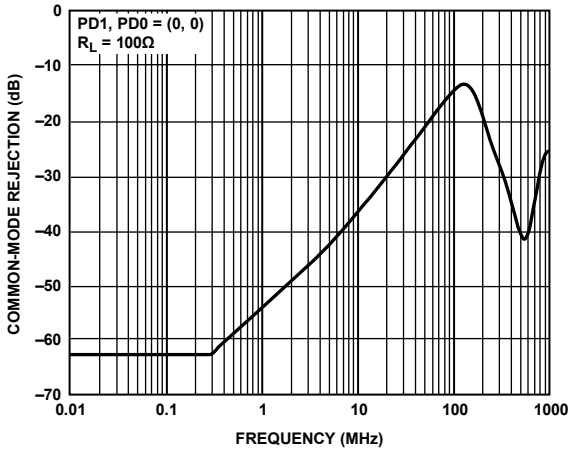

Figure 13. Common-Mode Rejection(CMR) vs. Frequency

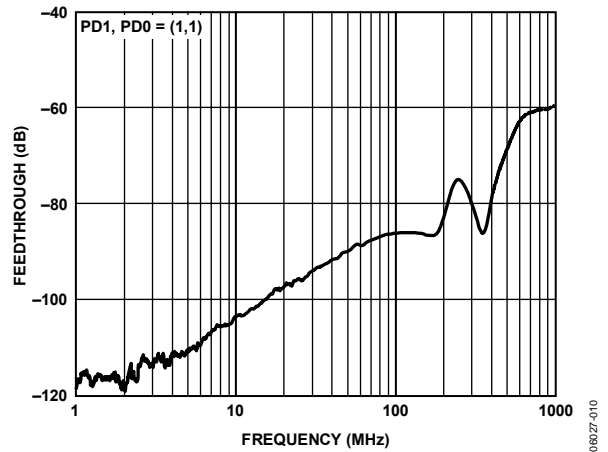

Figure 16. Off-Isolation vs. Frequency

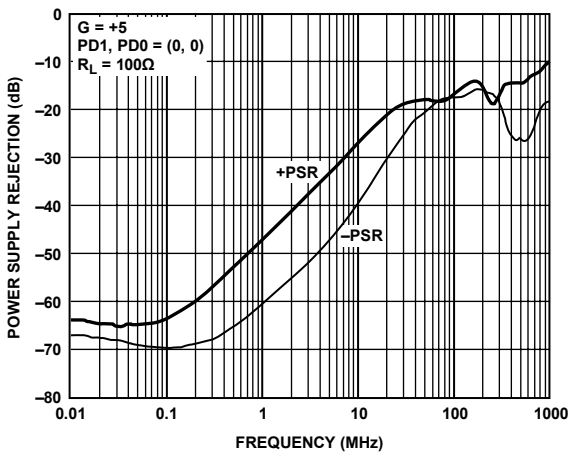

Figure 14. Power Supply Rejection(PSR) vs. Frequency

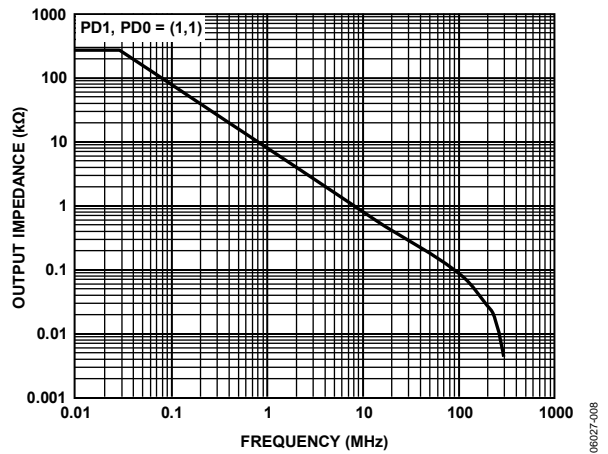

Figure 17. Output Impedance vs. Frequency (Disabled)

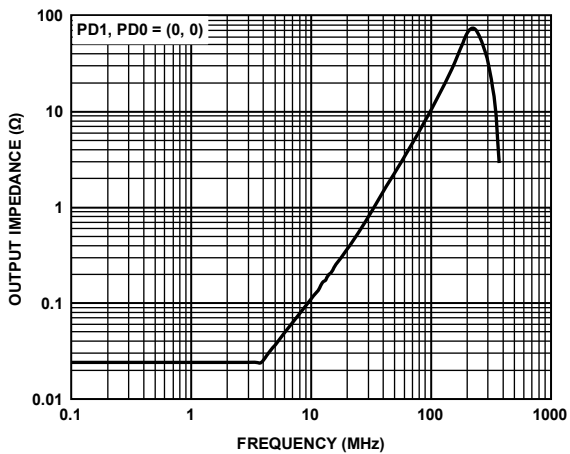

Figure 15. Closed-Loop Output Impedance vs. Frequency

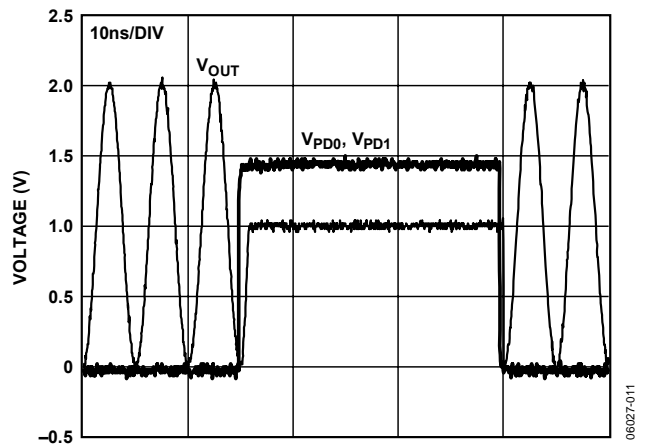

Figure 18. Power-Down Turn On/Turn Off



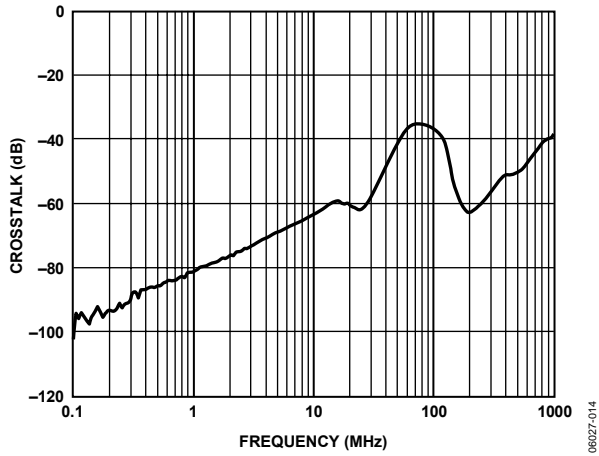

Figure 19. Crosstalk

06027-014

## THEORY OF OPERATION

The ADA4310-1 is a current feedback amplifier with high output current capability. With a current feedback amplifier, the current into the inverting input is the feedback signal, and the open-loop behavior is that of a transimpedance,  $dV_O/dI_{IN}$  or  $T_Z$ .

The open-loop transimpedance is analogous to the open-loop voltage gain of a voltage feedback amplifier. Figure 20 shows a simplified model of a current feedback amplifier. Because  $R_{IN}$  is proportional to  $1/g_m$ , the equivalent voltage gain is just  $T_Z \times g_m$ , where  $g_m$  is the transconductance of the input stage. Basic analysis of the follower with gain circuit yields

$$\frac{V_O}{V_{IN}} = G \times \frac{T_Z(s)}{T_Z(s) + G \times R_{IN} + R_F}$$

where:

$$G = 1 + \frac{R_F}{R_G}$$

$$R_{IN} = \frac{1}{g_m} \approx 50 \Omega$$

Because  $G \times R_{IN} \ll R_F$  for low gains, a current feedback amplifier has relatively constant bandwidth vs. gain, the 3 dB point being set when  $|T_Z| = R_F$ .

Of course, for a real amplifier there are additional poles that contribute excess phase, and there is a value for  $R_F$  below which the amplifier is unstable. Tolerance for peaking and desired flatness determines the optimum  $R_F$  in each application.

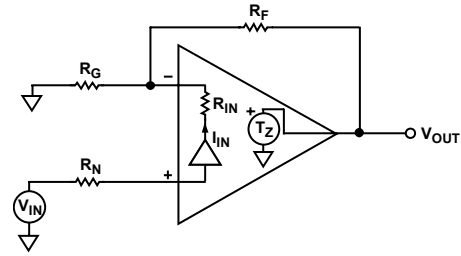

Figure 20. Simplified Block Diagram

## APPLICATION INFORMATION

### FEEDBACK RESISTOR SELECTION

The feedback resistor has a direct impact on the closed-loop bandwidth and stability of the current feedback op amp. Reducing the resistance below the recommended value can make the amplifier response peak and even become unstable. Increasing the size of the feedback resistor beyond the recommended value reduces the closed-loop bandwidth. Table 6 provides a convenient reference for quickly determining the feedback and gain resistor values, and the corresponding bandwidth, for common gain configurations. The recommended value of feedback resistor for the ADA4310-1 is 499  $\Omega$ .

**Table 6. Recommended Values and Frequency Performance<sup>1</sup>**

Gain	R <sub>F</sub> ( $\Omega$ )	R <sub>G</sub> ( $\Omega$ )	-3 dB SS BW (MHz)
+2	499	499	230
+5	499	124	190
+5	1k	249	125
+10	499	55.4	160
+20	499	26.1	115

<sup>1</sup> Conditions: V<sub>S</sub> =  $\pm 6$  V, T<sub>A</sub> = 25°C, R<sub>L</sub> = 50  $\Omega$ , PD1, PD0 = 0,0.

### POWER CONTROL MODES OF OPERATION

The ADA4310-1 features four power modes: full power,  $\frac{3}{4}$  power,  $\frac{1}{2}$  power, and shutdown. The power modes are controlled by two logic pins, PD0 and PD1. The power-down control pins are compatible with standard 3 V and 5 V CMOS logic. Table 7 shows the various power modes and associated logic states. In the power-down mode, the output of the amplifier goes into a high-impedance state.

**Table 7. Power Modes**

PD1	PD0	Power Mode	Total Supply Current (mA)	Output Impedance
Low	Low	Full Power	15.2	Low
Low	High	$\frac{3}{4}$ Power	11.2	Low
High	Low	$\frac{1}{2}$ Power	7.8	Low
High	High	Power Down	1.3	High

### EXPOSED THERMAL PAD CONNECTIONS

The exposed thermal pad on the 10-lead MSOP package is both the reference for the PD pins and the only electrical connection for the negative supply voltage. Therefore, in the 10-lead MSOP package, the ADA4310-1 can only be used on a single supply. The exposed thermal pad **MUST** be connected to ground. Failure to do so will render the part inoperable.

The 4 mm  $\times$  4 mm 16-lead LFCSP package has dedicated pins for both the positive and negative supplies, and it can be used in either single supply or dual supply applications. There is no electrical connection for the exposed thermal pad. Although the pad could theoretically be connected to any potential, it is still typically connected to ground.

A requirement for both packages is that the thermal pad be connected to a solid plane with low thermal resistance, ensuring adequate heat transfer away from the die and into the board.

### POWER LINE APPLICATION

Applications (that is, powerline AV modems) requiring greater than 10 dBm peak power should consider using an external line driver, such as the ADA4310-1. Figure 21 shows an example interface between the TxDAC<sup>®</sup> output and ADA4310-1 biased for single-supply operation. The TxDAC's peak-to-peak differential output voltage swing should be limited to 2 V p-p, with the ADA4310-1's gain configured to realize the additional voltage gain required by the application. A low-pass filter should be considered to filter the DAC images inherent in the signal reconstruction process. In addition, dc blocking capacitors are required to level-shift the TxDAC's output signal to the common-mode level of the ADA4310-1 (that is, AVDD/2).

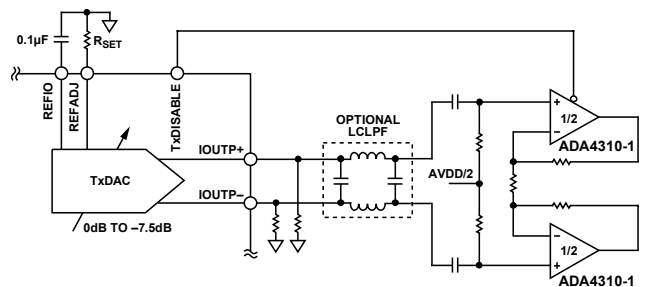

Figure 21. TxDAC Output Directly via Center-Tap Transformer

## BOARD LAYOUT

As is the case with all high speed applications, careful attention to printed circuit board layout details prevents associated board parasitics from becoming problematic. Proper RF design technique is mandatory. The PCB should have a ground plane covering all unused portions of the component side of the board to provide a low impedance return path. Removing the ground plane on all layers from the area near the input and output pins reduces stray capacitance, particularly in the area of the inverting inputs. Signal lines connecting the feedback and gain resistors should be as short as possible to minimize the inductance and stray capacitance associated with these traces. Termination resistors and loads should be located as close as possible to their respective inputs and outputs. Input and output traces should be kept as far apart as possible to minimize coupling (crosstalk) though the board. Wherever there are complementary signals, a symmetrical layout should be provided to the extent possible to maximize balanced performance. When running differential signals over a long distance, the traces on the PCB should be close. This reduces the radiated energy and makes the circuit less susceptible to RF interference. Adherence to stripline design techniques for long signal traces (greater than about 1 inch) is recommended.

For more information on high speed board layout, go to [www.analog.com](http://www.analog.com) and A Practical Guide to High-Speed Printed-Circuit-Board Layout.

## POWER SUPPLY BYPASSING

The ADA4310-1 operates on supplies, from +5 V to  $\pm 6$  V. The ADA4310-1 circuit should be powered with a well-regulated power supply. Careful attention must be paid to decoupling the power supply. High quality capacitors with low equivalent series resistance (ESR), such as multilayer ceramic capacitors (MLCCs), should be used to minimize supply voltage ripple and power dissipation. In addition, 0.1  $\mu$ F MLCC decoupling capacitors should be located no more than  $\frac{1}{8}$ -inch away from each of the power supply pins. A large, usually tantalum, 10  $\mu$ F capacitor is required to provide good decoupling for lower frequency signals and to supply current for fast, large signal changes at the ADA4310-1 outputs. Bypassing capacitors should be laid out in such a manner to keep return currents away from the inputs of the amplifiers. This minimizes any voltage drops that can develop due to ground currents flowing through the ground plane. A large ground plane also provides a low impedance path for the return currents.

# OUTLINE DIMENSIONS

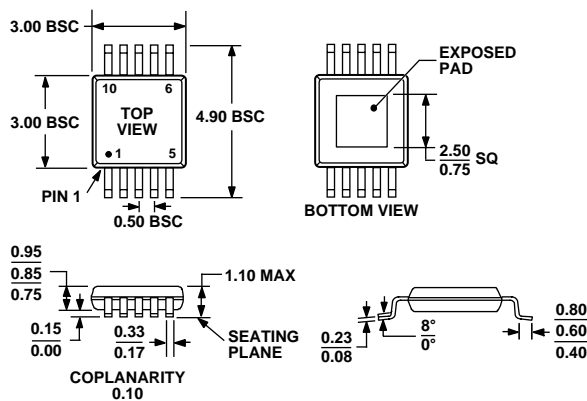

COMPLIANT TO JEDEC STANDARDS MO-187-BA-T

Figure 22. 10-Lead Mini Small Outline Package with Exposed Pad [MINI\_SO\_EP] (RH-10)

Dimensions shown in millimeters

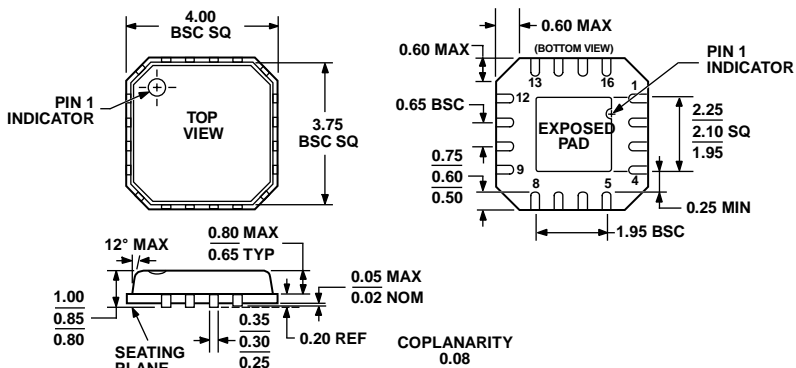

COMPLIANT TO JEDEC STANDARDS MO-220-VGGC

Figure 23. 16-Lead Lead Frame Chip Scale Package [LFCSP\_VQ]

4 mm x 4 mm Body, Very Thin Quad

(CP-16-4)

Dimensions shown in millimeters

## ORDERING GUIDE

Model	Temperature Package	Package Description	Package Option	Branding
ADA4310-1ARHZ-RL <sup>1</sup>	-40°C to +85°C	10-Lead Mini Small Outline Package with Exposed Pad [MINI_SO_EP]	RH-10	0L
ADA4310-1ARHZ-R7 <sup>1</sup>	-40°C to +85°C	10-Lead Mini Small Outline Package with Exposed Pad [MINI_SO_EP]	RH-10	0L
ADA4310-1ARHZ <sup>1</sup>	-40°C to +85°C	10-Lead Mini Small Outline Package with Exposed Pad [MINI_SO_EP]	RH-10	0L
ADA4310-1ACPZ-RL <sup>1</sup>	-40°C to +85°C	16-Lead Lead Frame Chip Scale Package [LFCSP_VQ]	CP-16-4	
ADA4310-1ACPZ-R2 <sup>1</sup>	-40°C to +85°C	16-Lead Lead Frame Chip Scale Package [LFCSP_VQ]	CP-16-4	
ADA4310-1ACPZ-R7 <sup>1</sup>	-40°C to +85°C	16-Lead Lead Frame Chip Scale Package [LFCSP_VQ]	CP-16-4	

<sup>1</sup> Z = Pb-free part.

**ADA4310-1**

**NOTES**

**NOTES**

**ADA4310-1**

**NOTES**



Компания «Океан Электроники» предлагает заключение долгосрочных отношений при поставках импортных электронных компонентов на взаимовыгодных условиях!

Наши преимущества:

- Поставка оригинальных импортных электронных компонентов напрямую с производств Америки, Европы и Азии, а так же с крупнейших складов мира;
- Широкая линейка поставок активных и пассивных импортных электронных компонентов (более 30 млн. наименований);
- Поставка сложных, дефицитных, либо снятых с производства позиций;
- Оперативные сроки поставки под заказ (от 5 рабочих дней);
- Экспресс доставка в любую точку России;
- Помощь Конструкторского Отдела и консультации квалифицированных инженеров;
- Техническая поддержка проекта, помощь в подборе аналогов, поставка прототипов;
- Поставка электронных компонентов под контролем ВП;
- Система менеджмента качества сертифицирована по Международному стандарту ISO 9001;
- При необходимости вся продукция военного и аэрокосмического назначения проходит испытания и сертификацию в лаборатории (по согласованию с заказчиком);
- Поставка специализированных компонентов военного и аэрокосмического уровня качества (Xilinx, Altera, Analog Devices, Intersil, Interpoint, Microsemi, Actel, Aeroflex, Peregrine, VPT, Syfer, Eurofarad, Texas Instruments, MS Kennedy, Miteq, Cobham, E2V, MA-COM, Hittite, Mini-Circuits, General Dynamics и др.);

Компания «Океан Электроники» является официальным дистрибьютором и эксклюзивным представителем в России одного из крупнейших производителей разъемов военного и аэрокосмического назначения «**JONHON**», а так же официальным дистрибьютором и эксклюзивным представителем в России производителя высокотехнологичных и надежных решений для передачи СВЧ сигналов «**FORSTAR**».



## JONHON

«**JONHON**» (основан в 1970 г.)

Разъемы специального, военного и аэрокосмического назначения:

(Применяются в военной, авиационной, аэрокосмической, морской, железнодорожной, горно- и нефтедобывающей отраслях промышленности)

«**FORSTAR**» (основан в 1998 г.)

ВЧ соединители, коаксиальные кабели,  
кабельные сборки и микроволновые компоненты:

(Применяются в телекоммуникациях гражданского и специального назначения, в средствах связи, РЛС, а так же военной, авиационной и аэрокосмической отраслях промышленности).



Телефон: 8 (812) 309-75-97 (многоканальный)

Факс: 8 (812) 320-03-32

Электронная почта: [ocean@oceanchips.ru](mailto:ocean@oceanchips.ru)

Web: <http://oceanchips.ru/>

Адрес: 198099, г. Санкт-Петербург, ул. Калинина, д. 2, корп. 4, лит. А