

PS8551L4

Data Sheet

R08DS0039EJ0200

Rev.2.00

Sep 06, 2011

ANALOG OUTPUT TYPE
 OPTICAL COUPLED ISOLATION AMPLIFIER

DESCRIPTION

The PS8551L4 is an optically coupled isolation amplifier that uses an IC with a high-accuracy sigma-delta A/D converter and a GaAlAs light-emitting diode with high-speed response and high luminance efficiency on the input side, and an IC with a high-accuracy D/A converter on the output side.

The PS8551L4 is designed specifically for high common mode transient immunity (CMTI) and high linearity (non-linearity). The PS8551L4 is suitable for current sensing in motor drives.

FEATURES

- Non-linearity (NL₂₀₀ = 0.35% MAX.)
- High common mode transient immunity (CMTI = 10 kV/ μ s MIN.)
- High isolation voltage (BV = 5 000 Vr.m.s.)
- Gain tolerance (G = 7.76 to 8.24 (\pm 3%))
 Gain: 8 V/V TYP.
- Package: 8-pin DIP lead bending type (Gull-wing) for long creepage distance for surface mount (L4)
- Embossed tape product: PS8551L4-E3 : 1 000 pcs/reel
- Pb-Free product
- Safety standards
 - UL approved: No. E72422
 - CSA approved: No. CA 101391 (CA5A, CAN/CSA-C22.2 60065, 60950)
 - SEMKO approved: No. 1111155
 - DIN EN60747-5-2 (VDE0884 Part2) approved: No. 40019182 (Option)

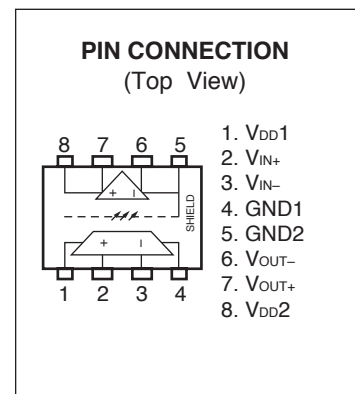

APPLICATIONS

- AC Servo, inverter
- Measurement equipment

The mark <R> shows major revised points.

The revised points can be easily searched by copying an "<R>" in the PDF file and specifying it in the "Find what:" field.

PS8551L4

PACKAGE DIMENSIONS (UNIT: mm)

Lead Bending Type (Gull-wing) For Long Creepage Distance For Surface Mount (L4)

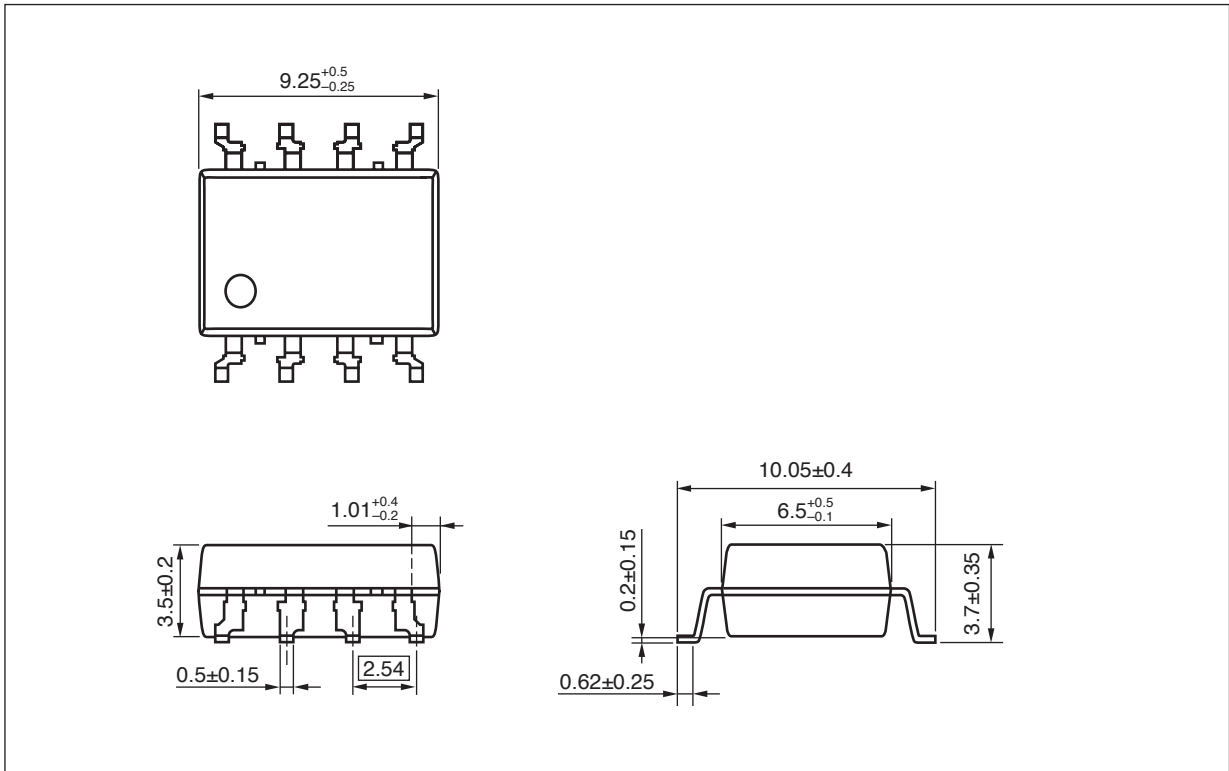

PHOTOCOUPLER CONSTRUCTION

Parameter	Unit (MIN.)
Air Distance	8 mm
Outer Creepage Distance	8 mm
Isolation Distance	0.4 mm

PS8551L4

<R> **MARKING EXAMPLE**

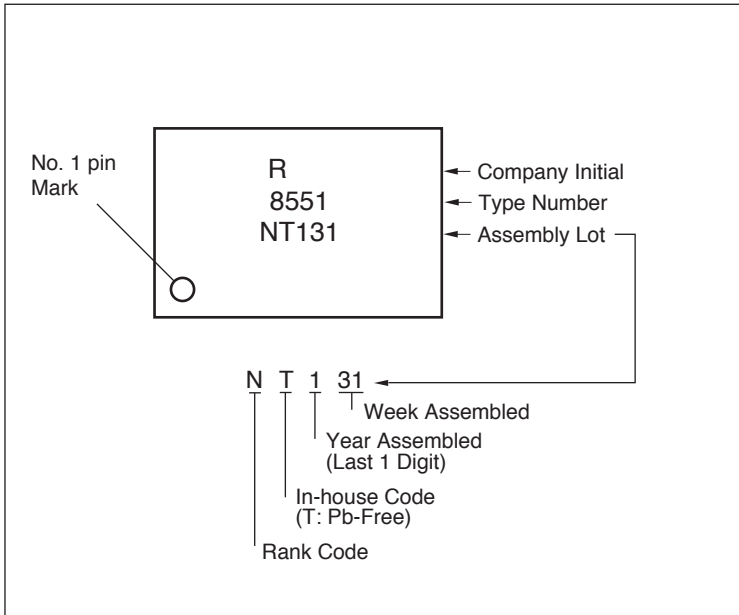

ORDERING INFORMATION

Part Number	Order Number	Solder Plating Specification	Packing Style	Safety Standard Approval	Application Part Number*1
PS8551L4	PS8551L4-AX	Pb-Free (Ni/Pd/Au)	Magazine case 50 pcs	Standard products (UL, CSA, SEMKO approved)	PS8551L4
PS8551L4-E3	PS8551L4-E3-AX		Embossed Tape 1 000 pcs/reel		
PS8551L4-V	PS8551L4-V-AX		Magazine case 50 pcs	DIN EN60747-5-2	
PS8551L4-V-E3	PS8551L4-V-E3-AX		Embossed Tape 1 000 pcs/reel	(VDE0884 Part2) Approved (Option)	

*1 For the application of the Safety Standard, following part number should be used.

ABSOLUTE MAXIMUM RATINGS (T_A = 25°C, unless otherwise specified)

Parameter	Symbol	Ratings	Unit
Operating Ambient Temperature	T _A	-40 to +85	°C
Storage Temperature	T _{stg}	-55 to +125	°C
Supply Voltage	V _{DD1} , V _{DD2}	0 to 5.5	V
Input Voltage	V _{IN+} , V _{IN-}	-2 to V _{DD1} +0.5	V
2 Seconds Transient Input Voltage	V _{IN+} , V _{IN-}	-6 to V _{DD1} +0.5	V
Output Voltage	V _{OUT+} , V _{OUT-}	-0.5 to V _{DD2} +0.5	V
Isolation Voltage ^{*1}	BV	5 000	Vr.m.s.

*1 AC voltage for 1 minute at T_A = 25°C, RH = 60% between input and output.
Pins 1-4 shorted together, 5-8 shorted together.

RECOMMENDED OPERATING CONDITIONS

Parameter	Symbol	MIN.	MAX.	Unit
Operating Ambient Temperature	T _A	-40	85	°C
Supply Voltage	V _{DD1} , V _{DD2}	4.5	5.5	V
Input Voltage (Accurate and Linear) ^{*1}	V _{IN+} , V _{IN-}	-200	200	mV

*1 Using V_{IN-} = 0 V (to be connected to GND1) is recommended. Avoid using V_{IN-} of 2.5 V or more, because the internal test mode is activated when the voltage V_{IN-} reaches more than 2.5 V.

ELECTRICAL CHARACTERISTICS (DC Characteristics)(TYP.: $T_A = 25^\circ\text{C}$, $V_{IN+} = V_{IN-} = 0\text{ V}$, $V_{DD1} = V_{DD2} = 5\text{ V}$,

MIN., MAX.: refer to RECOMMENDED OPERATING CONDITIONS, unless otherwise specified)

Parameter	Symbol	Conditions	MIN.	TYP.	MAX.	Unit
Input Offset Voltage	V_{OS}	$T_A = 25^\circ\text{C}$	-2	0.3	2	mV
			-3		3	
Input Offset Voltage Drift vs. Temperature	$ dV_{OS}/dT_A $	$T_A = 25\text{ to }+85^\circ\text{C}$		3	10	$\mu\text{V}/^\circ\text{C}$
Gain ^{*1}	G	$-200\text{ mV} \leq V_{IN+} \leq 200\text{ mV}$, $T_A = 25^\circ\text{C}$	7.76	8	8.24	V/V
Gain Drift vs. Temperature	$ dG/dT_A $			0.00087		V/V $^\circ\text{C}$
V_{OUT} Non-linearity (200 mV) ^{*2}	NL200	$-200\text{ mV} \leq V_{IN+} \leq 200\text{ mV}$		0.021	0.35	%
V_{OUT} Non-linearity (200 mV) Drift vs. Temperature	$ dNL200/dT_A $			0.0002		%/ $^\circ\text{C}$
V_{OUT} Non-linearity (100 mV) ^{*2}	NL100	$-100\text{ mV} \leq V_{IN+} \leq 100\text{ mV}$		0.014	0.2	%
Maximum Input Voltage before V_{OUT} Clipping	$ V_{IN+} _{MAX.}$			308		mV
Input Supply Current	I_{DD1}	$V_{IN+} = 400\text{ mV}$		16	20	mA
Output Supply Current	I_{DD2}	$V_{IN+} = -400\text{ mV}$		10	16	mA
Input Bias Current	I_{IN+}	$V_{IN+} = 0\text{ V}$		-0.5	5	μA
Input Bias Current Drift vs. Temperature	$ dI_{IN+}/dT_A $			0.45		nA/ $^\circ\text{C}$
Low Level Saturated Output Voltage	V_{OL}	$V_{IN+} = -400\text{ mV}$		1.29		V
High Level Saturated Output Voltage	V_{OH}	$V_{IN+} = 400\text{ mV}$		3.8		V
Output Voltage ($V_{IN+} = V_{IN-} = 0\text{ V}$)	V_{OCM}	$V_{IN+} = V_{IN-} = 0\text{ V}$	2.2	2.55	2.8	V
Output Short-circuit Current	$ I_{OSC} $			18.6		mA
Equivalent Input Resistance	R_{IN}			320		k Ω
V_{OUT} Output Resistance	R_{OUT}			15		Ω
Input DC Common-Mode Rejection Ratio ^{*3}	CMRR _{IN}			76		dB

*1 The differential output voltage ($V_{OUT+} - V_{OUT-}$) with respect to the differential input voltage ($V_{IN+} - V_{IN-}$), where $V_{IN+} = -200\text{ mV}$ to 200 mV and $V_{IN-} = 0\text{ V}$ is measured under the circuit shown in **Fig. 2 NL200, G Test Circuit**. Upon the resulting chart, the gain is defined as the slope of the optimum line obtained by using the method of least squares.

*2 The differential output voltage ($V_{OUT+} - V_{OUT-}$) with respect to the differential input voltage ($V_{IN+} - V_{IN-}$) is measured under the circuit shown in **Fig. 2 NL200, G Test Circuit**. Upon the resulting chart, the optimum line is obtained by using the method of least squares. Non-linearity is defined as the ratio (%) of the optimum line obtained by dividing [Half of the peak to peak value of the (residual) deviation] by [full-scale differential output voltage].

For example, if the differential output voltage is 3.2 V, and the peak to peak value of the (residual) deviation is 22.4 mV, while the input V_{IN+} is $\pm 200\text{ mV}$, the output non-linearity is obtained as follows:

$$NL200 = 22.4 / (2 \times 3200) = 0.35\%$$

*3 CMRR_{IN} is defined as the ratio of the differential signal gain (when the differential signal is applied between the input pins) to the common-mode signal gain (when both input pins are connected and the signal is applied). This value is indicated in dB.

<R>

ELECTRICAL CHARACTERISTICS (AC Characteristics)(TYP.: $T_A = 25^\circ\text{C}$, $V_{IN+} = V_{IN-} = 0\text{ V}$, $V_{DD1} = V_{DD2} = 5\text{ V}$,

MIN., MAX.: refer to RECOMMENDED OPERATING CONDITIONS, unless otherwise specified)

Parameter	Symbol	Conditions	MIN.	TYP.	MAX.	Unit
V_{OUT} Bandwidth (-3 dB)	f_c	$V_{IN+} = 200\text{ mV}_{p-p}$, sine wave	50	100		kHz
V_{OUT} Noise	N_{OUT}	$V_{IN+} = 0\text{ V}$		31.5		mVr.m.s.
V_{IN} to V_{OUT} Signal Delay (50 to 10%)	t_{PD10}	$V_{IN+} = 0$ to 150 mV step		2.03	3.3	μs
V_{IN} to V_{OUT} Signal Delay (50 to 50%)	t_{PD50}			4.01	5.6	
V_{IN} to V_{OUT} Signal Delay (50 to 90%)	t_{PD90}			6.02	9.9	
V_{OUT} Rise Time/Fall Time (10 to 90%)	t_r/t_f	$V_{IN+} = 0$ to 150 mV step		3.53	6.6	μs
Common Mode Transient Immunity ^{*1}	CMTI	$V_{CM} = 0.5\text{ kV}$, $T_A = 25^\circ\text{C}$	10	25		kV/ μs
Power Supply Noise Rejection ^{*2}	PSR	$f = 1\text{ MHz}$		100		mVr.m.s.

*1 CMTI is tested by applying a pulse that rises and falls suddenly ($V_{CM} = 0.5\text{ kV}$) between GND1 on the input side and GND2 on the output side (pins 4 and 5) by using the circuit shown in **Fig. 9 CMTI Test Circuit**. CMTI is defined at the point where the differential output voltage ($V_{OUT+} - V_{OUT-}$) fluctuates 200 mV ($>1\ \mu\text{s}$) or more from the average output voltage.

*2 This is the value of the transient voltage at the differential output when 1 V_{p-p} , 1 MHz, and 40 ns rise/fall time square wave is applied to both V_{DD1} and V_{DD2} .

TEST CIRCUIT

Fig. 1 Vos Test Circuit

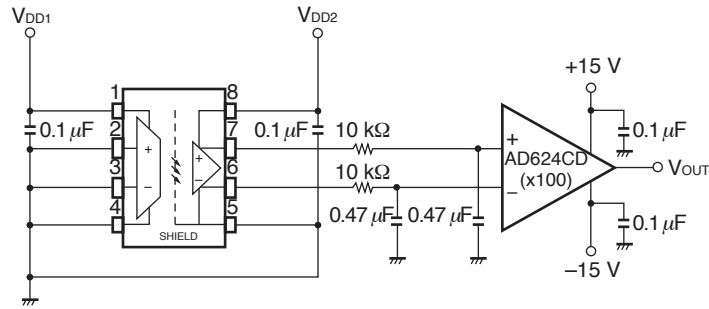

Fig. 2 NL200, G Test Circuit

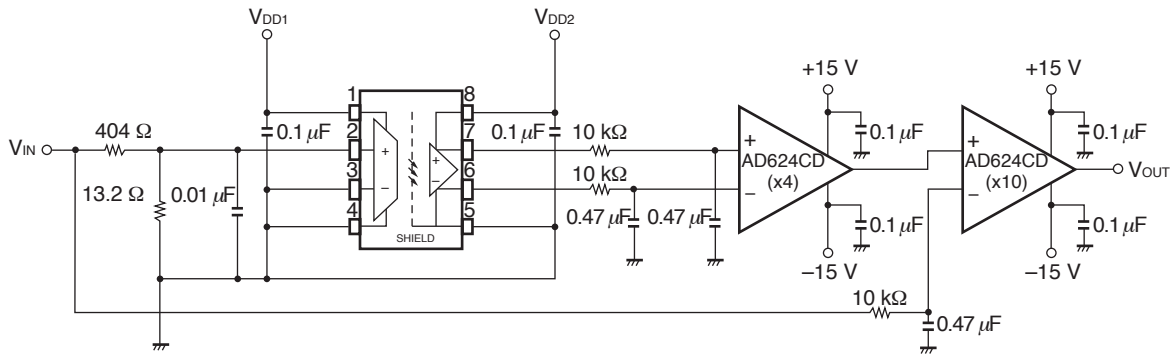

Fig. 3 I_{DD1} Test Circuit

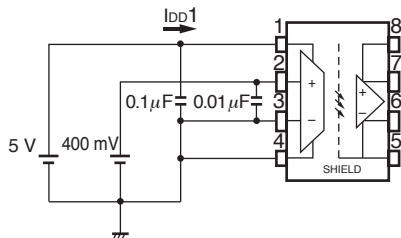

Fig. 4 I_{DD2} Test Circuit

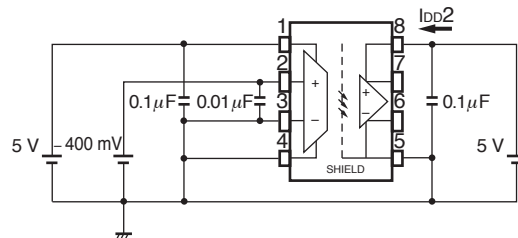

Fig. 5 I_{IN+} Test Circuit

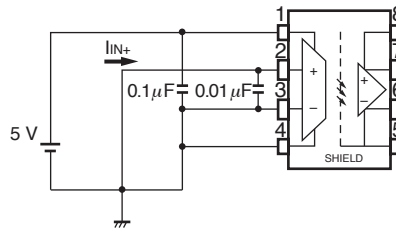
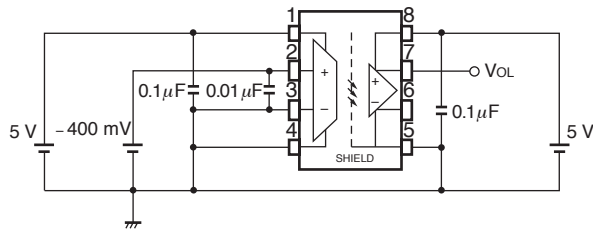
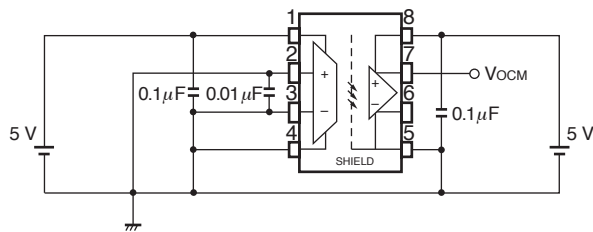

Fig. 6 V_{OUT} Test Circuit

V_{OL}



V_{OCM}



V_{OH}

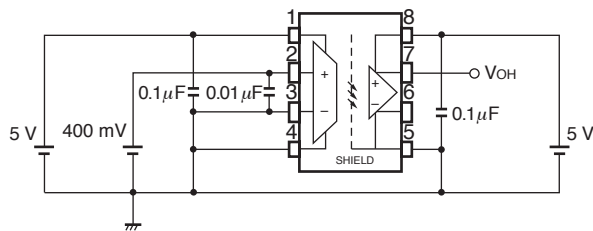

Fig. 7 Iloscl Test Circuit

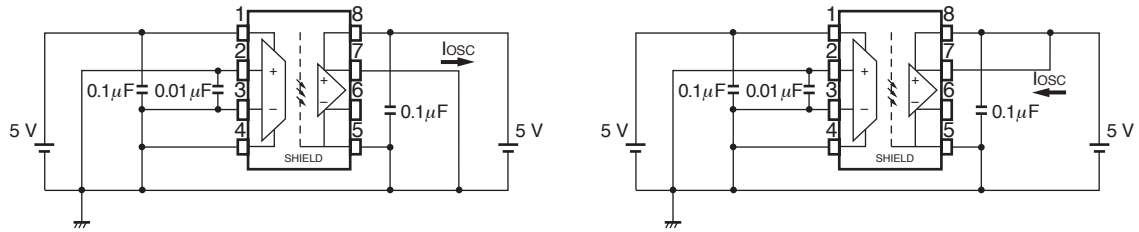

Fig. 8 tPD Test Circuit

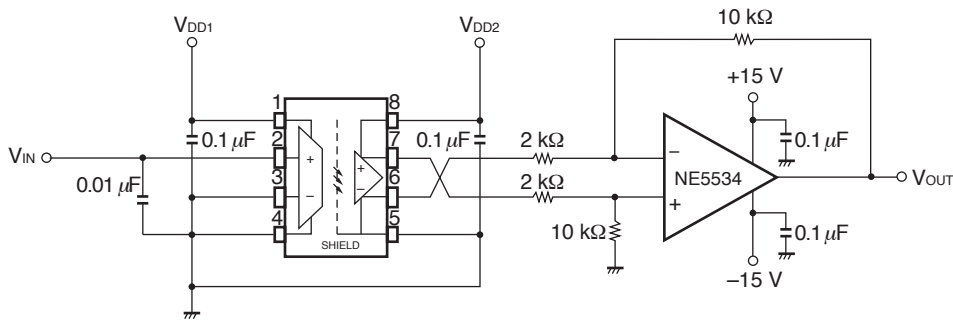
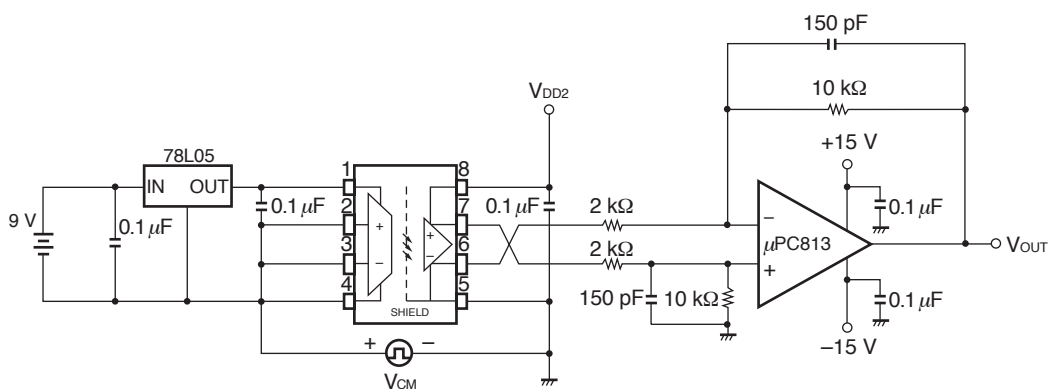
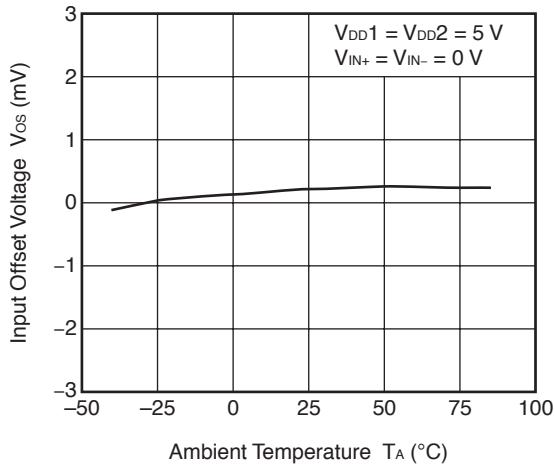

Fig. 9 CMTI Test Circuit



TYPICAL CHARACTERISTICS (T_A = 25°C, unless otherwise specified)

INPUT OFFSET VOLTAGE vs. AMBIENT TEMPERATURE



INPUT OFFSET VOLTAGE vs. SUPPLY VOLTAGE

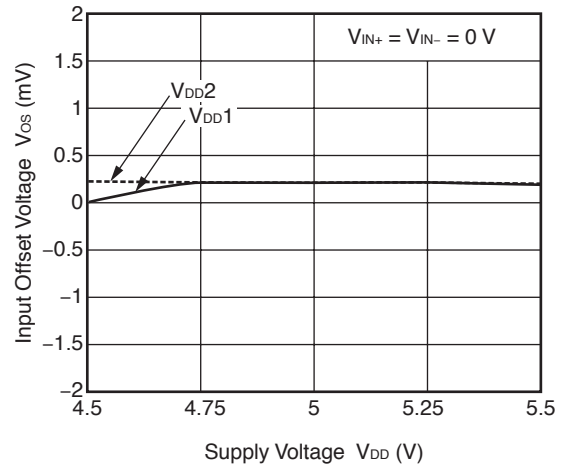

GAIN vs. AMBIENT TEMPERATURE

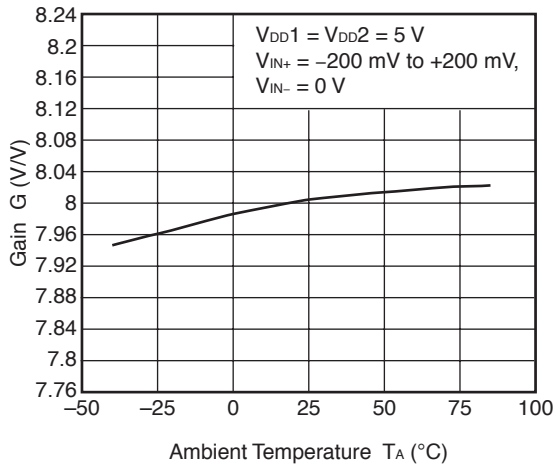

GAIN vs. SUPPLY VOLTAGE

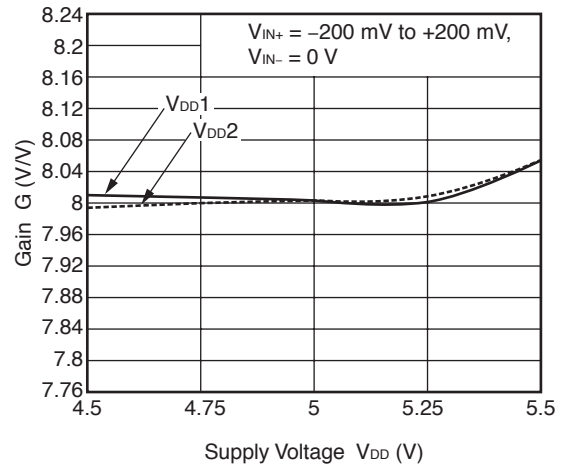

NON-LINEARITY vs. AMBIENT TEMPERATURE

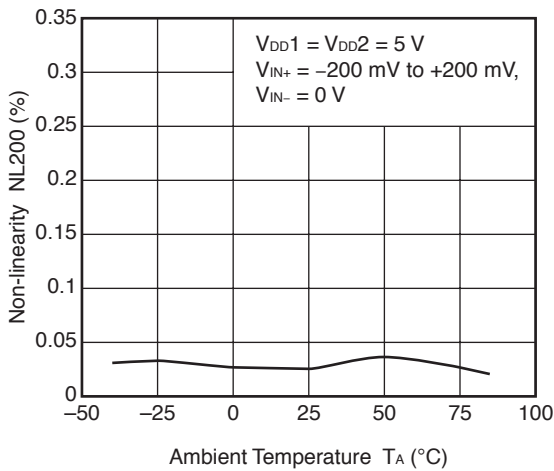

NON-LINEARITY vs. SUPPLY VOLTAGE

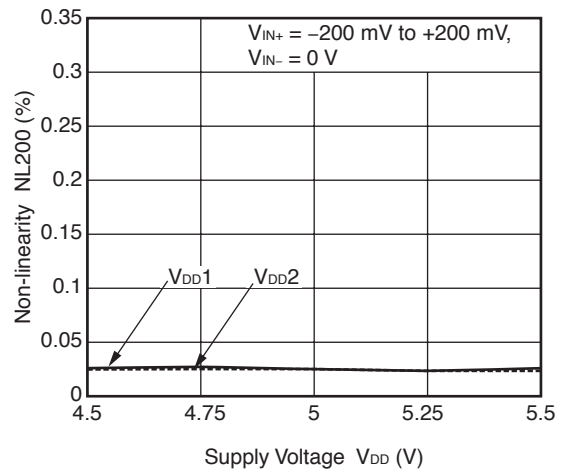

Remark The graphs indicate nominal characteristics.

INPUT VOLTAGE vs. OUTPUT VOLTAGE

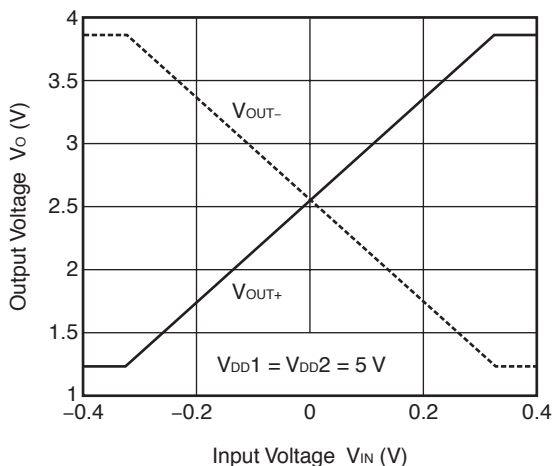

SUPPLY CURRENT vs. INPUT VOLTAGE

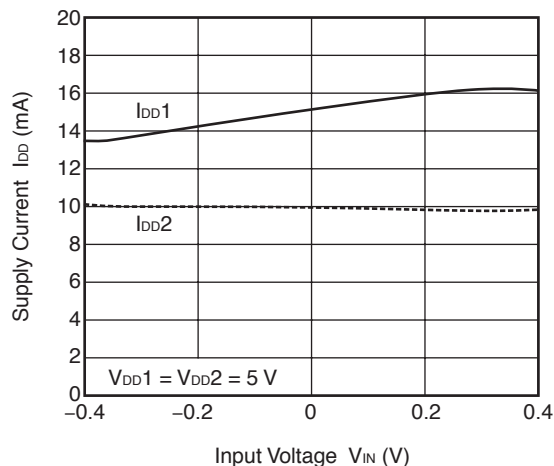

INPUT CURRENT vs. INPUT VOLTAGE

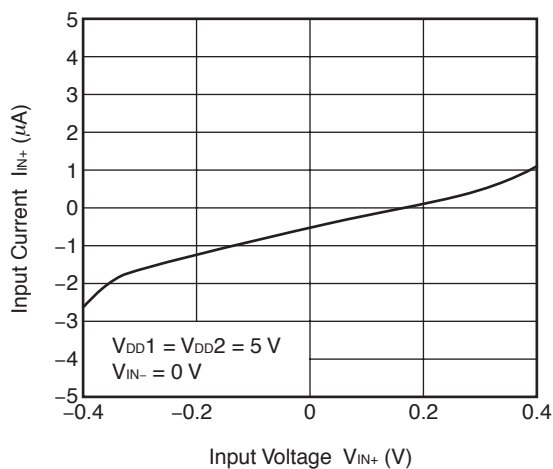

GAIN vs. FREQUENCY

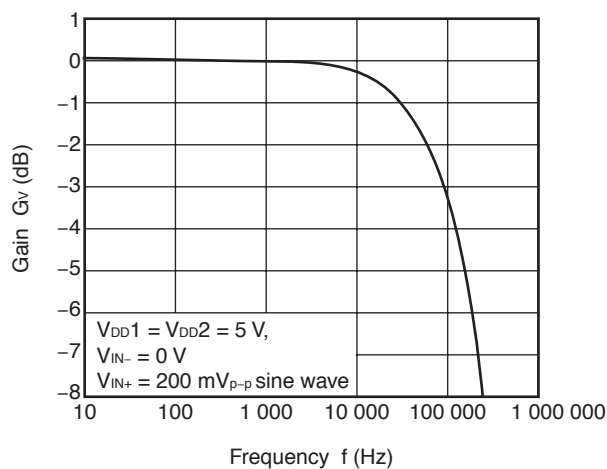

PHASE vs. FREQUENCY

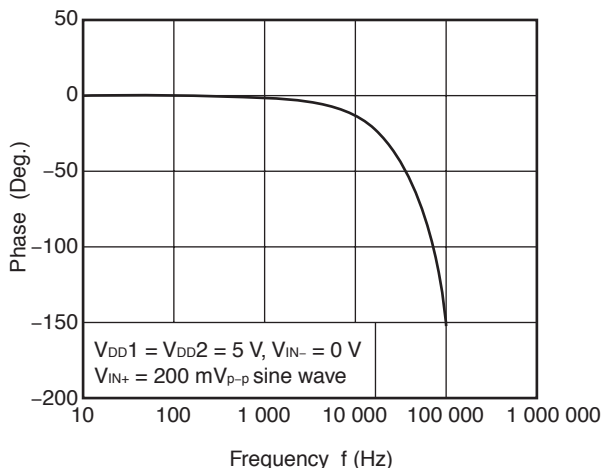

SIGNAL DELAY TIME vs. AMBIENT TEMPERATURE

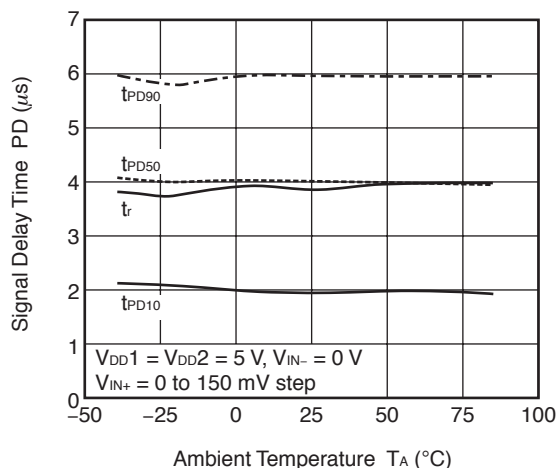

Remark The graphs indicate nominal characteristics.

TAPING SPECIFICATIONS (UNIT: mm)

Outline and Dimensions (Tape)

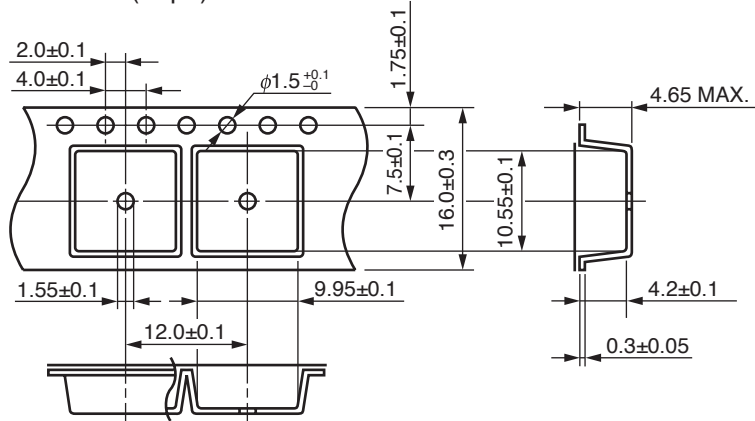

Tape Direction

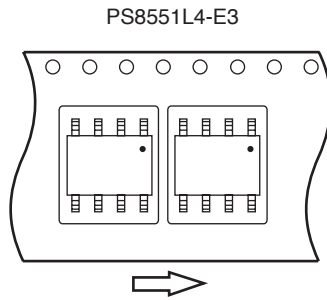

Outline and Dimensions (Reel)

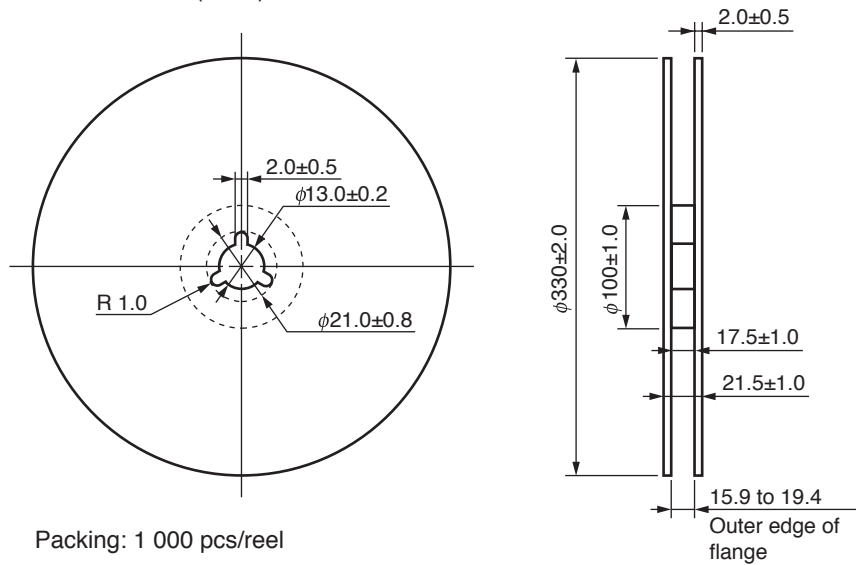

PS8551L4

RECOMMENDED MOUNT PAD DIMENSIONS (UNIT: mm)

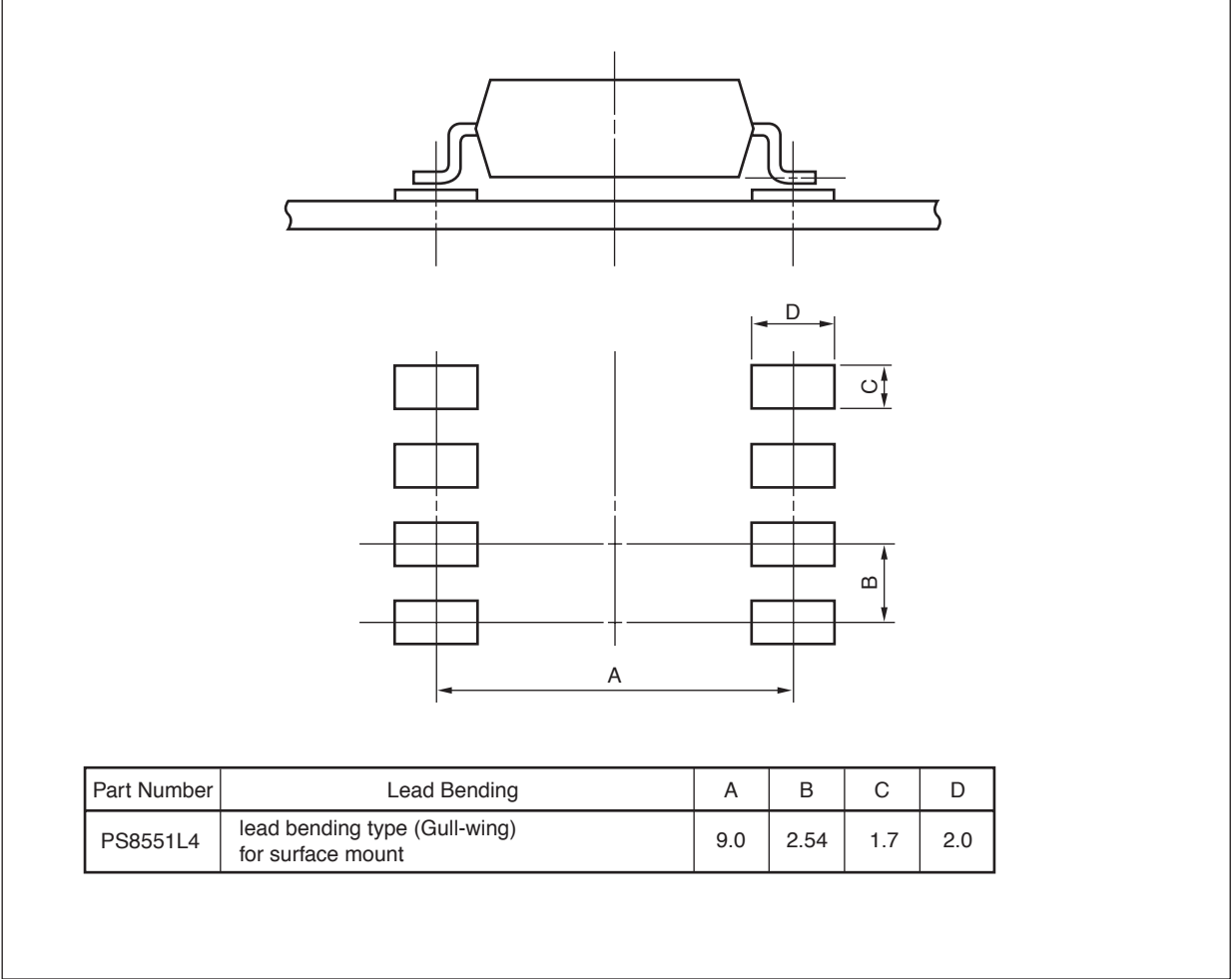

NOTES ON HANDLING

1. Recommended soldering conditions

(1) Infrared reflow soldering

- Peak reflow temperature 260°C or below (package surface temperature)
- Time of peak reflow temperature 10 seconds or less
- Time of temperature higher than 220°C 60 seconds or less
- Time to preheat temperature from 120 to 180°C 120±30 s
- Number of reflows Three
- Flux Rosin flux containing small amount of chlorine (The flux with a maximum chlorine content of 0.2 Wt% is recommended.)

Recommended Temperature Profile of Infrared Reflow

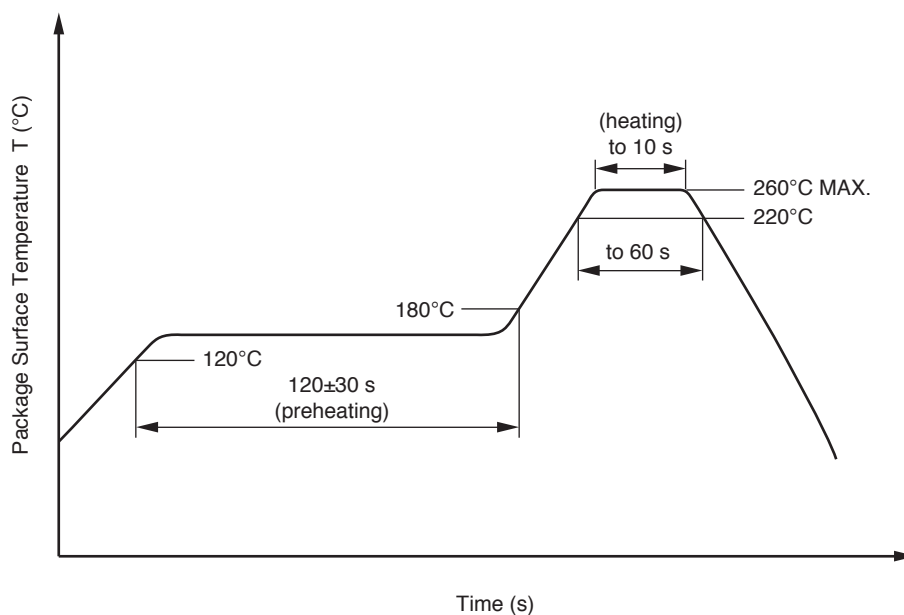

(2) Wave soldering

- Temperature 260°C or below (molten solder temperature)
- Time 10 seconds or less
- Preheating conditions 120°C or below (package surface temperature)
- Number of times One (Allowed to be dipped in solder including plastic mold portion.)
- Flux Rosin flux containing small amount of chlorine (The flux with a maximum chlorine content of 0.2 Wt% is recommended.)

(3) Soldering by Soldering Iron

- Peak Temperature (lead part temperature) 350°C or below
- Time (each pins) 3 seconds or less
- Flux Rosin flux containing small amount of chlorine (The flux with a maximum chlorine content of 0.2 Wt% is recommended.)

(a) Soldering of leads should be made at the point 1.5 to 2.0 mm from the root of the lead

PS8551L4

(4) Cautions

• Fluxes

Avoid removing the residual flux with freon-based and chlorine-based cleaning solvent.

2. Cautions regarding noise

Be aware that when voltage is applied suddenly between the photocoupler's input and output at startup, the output transistor may enter the on state, even if the voltage is within the absolute maximum ratings.

USAGE CAUTIONS

1. This product is weak for static electricity by designed with high-speed integrated circuit so protect against static electricity when handling.
2. Board designing
 - (1) By-pass capacitor of more than 0.1 μ F is used between V_{CC} and GND near device. Also, ensure that the distance between the leads of the photocoupler and capacitor is no more than 10 mm.
 - (2) Keep the pattern connected the input (V_{IN+} , V_{IN-}) and the output (V_{OUT+} , V_{OUT-}), respectively, as short as possible.
 - (3) Do not connect any routing to the portion of the frame exposed between the pins on the package of the photocoupler. If connected, it will affect the photocoupler's internal voltage and the photocoupler will not operate normally.
 - (4) Because the maximum frequency of the signal input to the photocoupler must be lower than the allowable frequency band, be sure to connect an anti-aliasing filter (an RC filter with $R = 68 \Omega$ and $C = 0.01 \mu$ F, for example).
 - (5) The signals output from the PS8551 include noise elements such as chopping noise and quantization noise generated internally. Therefore, be sure to restrict the output frequency to the required bandwidth by adding a low-pass filter function (an RC filter with $R = 10 \text{ k}\Omega$ and $C = 150 \text{ pF}$, for example) to the operational amplifier (post amplifier) in the next stage to the PS8551.
3. Avoid storage at a high temperature and high humidity.

SPECIFICATION OF VDE MARKS LICENSE DOCUMENT

Parameter	Symbol	Spec.	Unit
Climatic test class (IEC 60068-1/DIN EN 60068-1)		40/085/21	
Dielectric strength			
maximum operating isolation voltage	U_{IORM}	1 130	V_{peak}
Test voltage (partial discharge test, procedure a for type test and random test) $U_{pr} = 1.5 \times U_{IORM}$, $P_d < 5$ pC	U_{pr}	1 695	V_{peak}
Test voltage (partial discharge test, procedure b for all devices) $U_{pr} = 1.875 \times U_{IORM}$, $P_d < 5$ pC	U_{pr}	2 119	V_{peak}
Highest permissible overvoltage	U_{TR}	8 000	V_{peak}
Degree of pollution (DIN EN 60664-1 VDE0110 Part 1)		2	
Comparative tracking index (IEC 60112/DIN EN 60112 (VDE 0303 Part 11))	CTI	175	
Material group (DIN EN 60664-1 VDE0110 Part 1)		III a	
Storage temperature range	T_{stg}	-55 to +125	°C
Operating temperature range	T_A	-40 to +85	°C
Isolation resistance, minimum value $V_{IO} = 500$ V dc at $T_A = 25^\circ\text{C}$ $V_{IO} = 500$ V dc at T_A MAX. at least 100°C	Ris MIN. Ris MIN.	10^{12} 10^{11}	Ω Ω
Safety maximum ratings (maximum permissible in case of fault, see thermal derating curve)			
Package temperature	T_{si}	175	°C
Current (input current I_F , $P_{si} = 0$)	I_{si}	400	mA
Power (output or total power dissipation)	P_{si}	700	mW
Isolation resistance $V_{IO} = 500$ V dc at $T_A = T_{si}$	Ris MIN.	10^9	Ω

Caution	GaAs Products	<p>This product uses gallium arsenide (GaAs). GaAs vapor and powder are hazardous to human health if inhaled or ingested, so please observe the following points.</p> <ul style="list-style-type: none">• Follow related laws and ordinances when disposing of the product. If there are no applicable laws and/or ordinances, dispose of the product as recommended below.<ol style="list-style-type: none">1. Commission a disposal company able to (with a license to) collect, transport and dispose of materials that contain arsenic and other such industrial waste materials.2. Exclude the product from general industrial waste and household garbage, and ensure that the product is controlled (as industrial waste subject to special control) up until final disposal.• Do not burn, destroy, cut, crush, or chemically dissolve the product.• Do not lick the product or in any way allow it to enter the mouth.
----------------	---------------	--

Revision History	PS8551L4 Data Sheet
-------------------------	----------------------------

Rev.	Date	Description	
		Page	Summary
-	Sep 2007	-	Previous No. :PN10670EJ01V0DS
1.00	Jun 14, 2011	Throughout	Preliminary Data Sheet -> Data Sheet
		Throughout	Safety standards approved
		p.3	Modification of MARKING EXAMPLE Addition of ORDERING INFORMATION
		p.4	Modification of ABSOLUTE MAXIMUM RATINGS Modification of RECOMMENDED OPERATING CONDITIONS
		p.5	Modification of ELECTRICAL CHARACTERISTICS (DC Characteristics)
		p.6	Modification of SWITCHING CHARACTERISTICS (ADC Characteristics)
		pp.7 to 9	Addition of TEST CIRCUIT
		pp.10, 11	Addition of TYPICAL CHARACTERISTICS
		p.13	Addition of RECOMMENDED MOUNT
		p.15	Modification of USAGE CAUTIONS
2.00	Sep 06, 2011	p.3	Modification of MARKING EXAMPLE
		p.5	Modification of ELECTRICAL CHARACTERISTICS (DC Characteristics) CMRR _{IN}

All trademarks and registered trademarks are the property of their respective owners.

Компания «Океан Электроники» предлагает заключение долгосрочных отношений при поставках импортных электронных компонентов на взаимовыгодных условиях!

Наши преимущества:

- Поставка оригинальных импортных электронных компонентов напрямую с производств Америки, Европы и Азии, а так же с крупнейших складов мира;
- Широкая линейка поставок активных и пассивных импортных электронных компонентов (более 30 млн. наименований);
- Поставка сложных, дефицитных, либо снятых с производства позиций;
- Оперативные сроки поставки под заказ (от 5 рабочих дней);
- Экспресс доставка в любую точку России;
- Помощь Конструкторского Отдела и консультации квалифицированных инженеров;
- Техническая поддержка проекта, помощь в подборе аналогов, поставка прототипов;
- Поставка электронных компонентов под контролем ВП;
- Система менеджмента качества сертифицирована по Международному стандарту ISO 9001;
- При необходимости вся продукция военного и аэрокосмического назначения проходит испытания и сертификацию в лаборатории (по согласованию с заказчиком);
- Поставка специализированных компонентов военного и аэрокосмического уровня качества (Xilinx, Altera, Analog Devices, Intersil, Interpoint, Microsemi, Actel, Aeroflex, Peregrine, VPT, Syfer, Eurofarad, Texas Instruments, MS Kennedy, Miteq, Cobham, E2V, MA-COM, Hittite, Mini-Circuits, General Dynamics и др.);

Компания «Океан Электроники» является официальным дистрибьютором и эксклюзивным представителем в России одного из крупнейших производителей разъемов военного и аэрокосмического назначения «JONHON», а так же официальным дистрибьютором и эксклюзивным представителем в России производителя высокотехнологичных и надежных решений для передачи СВЧ сигналов «FORSTAR».



JONHON

«JONHON» (основан в 1970 г.)

Разъемы специального, военного и аэрокосмического назначения:

(Применяются в военной, авиационной, аэрокосмической, морской, железнодорожной, горно- и нефтедобывающей отраслях промышленности)

«FORSTAR» (основан в 1998 г.)

ВЧ соединители, коаксиальные кабели, кабельные сборки и микроволновые компоненты:

(Применяются в телекоммуникациях гражданского и специального назначения, в средствах связи, РЛС, а так же военной, авиационной и аэрокосмической отраслях промышленности).



Телефон: 8 (812) 309-75-97 (многоканальный)

Факс: 8 (812) 320-03-32

Электронная почта: ocean@oceanchips.ru

Web: <http://oceanchips.ru/>

Адрес: 198099, г. Санкт-Петербург, ул. Калинина, д. 2, корп. 4, лит. А