



ATTENTION
OBSERVE PRECAUTIONS
FOR HANDLING
ELECTROSTATIC
DISCHARGE
SENSITIVE
DEVICES

Part Number: APBD3224LVBDSYKJ3C

Blue
Super Bright Yellow

Features

- 3.2x2.4mm SMD LED, 2.4mm thickness.
- Low power consumption.
- Ideal for backlight and indicator.
- Package : 1500pcs / reel.
- Moisture sensitivity level : level 3.
- Low current IF=2mA operating.
- RoHS compliant.

Descriptions

- The Blue source color devices are made with InGaN Light Emitting Diode.
- The Super Bright Yellow device is based on light emitting diode chip made from AlGaInP.
- Electrostatic discharge and power surge could damage the LEDs.
- It is recommended to use a wrist band or anti-electrostatic glove when handling the LEDs.
- All devices, equipments and machineries must be electrically grounded.

Package Dimensions

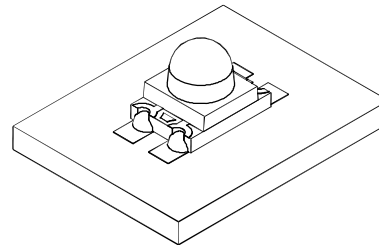
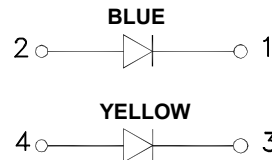
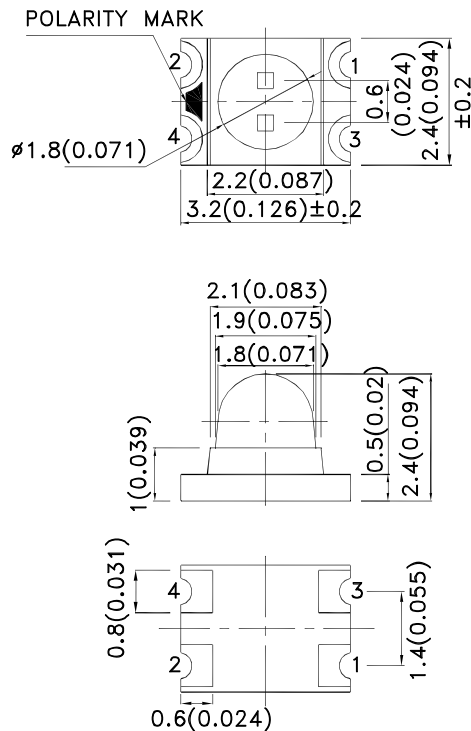

Notes:

1. All dimensions are in millimeters (inches).
2. Tolerance is $\pm 0.1(0.004)$ unless otherwise noted.
3. The specifications, characteristics and technical data described in the datasheet are subject to change without prior notice.
4. The device has a single mounting surface. The device must be mounted according to the specifications.



Selection Guide

Part No.	Emitting Color (Material)	Lens Type	Iv (mcd) [2] @ 2mA		Viewing Angle [1]
			Min.	Typ.	2θ1/2
APBD3224LVBDSYKJ3C	Blue (InGaN)	Water Clear	50	100	20°
	Super Bright Yellow (AlGaInP)		50	100	

Notes:

1. θ1/2 is the angle from optical centerline where the luminous intensity is 1/2 of the optical peak value.
2. Luminous intensity/ luminous Flux: +/-15%.
3. Luminous intensity value is traceable to the CIE127-2007 compliant national standards.

Electrical / Optical Characteristics at TA=25°C

Symbol	Parameter	Emitting Color	Min.	Typ.	Max.	Units	Test Conditions
λ _{peak}	Peak Wavelength	Blue Super Bright Yellow		465 590		nm	I _F =2mA
λ _D [1]	Dominant Wavelength	Blue Super Bright Yellow		470 590		nm	I _F =2mA
Δλ _{1/2}	Spectral Line Half-width	Blue Super Bright Yellow		22 20		nm	I _F =2mA
C	Capacitance	Blue Super Bright Yellow		100 45		pF	V _F =0V;f=1MHz
V _F [2]	Forward Voltage	Blue Super Bright Yellow	2.2 1.5	2.65 1.85	3 2.1	V	I _F =2mA
I _R	Reverse Current	Blue Super Bright Yellow			50 10	uA	V _R = 5V

Notes:

1. Wavelength: +/-1nm.
2. Forward Voltage: +/-0.1V.
3. Wavelength value is traceable to the CIE127-2007 compliant national standards.
4. Excess driving current and/or operating temperature higher than recommended conditions may result in severe light degradation or premature failure.

Absolute Maximum Ratings at TA=25°C

Parameter	Blue	Super Bright Yellow	Units
Power dissipation	90	75	mW
DC Forward Current	30	30	mA
Peak Forward Current [1]	100	140	mA
Electrostatic Discharge Threshold (HBM)	250	3000	V
Reverse Voltage	5		V
Operating Temperature	-40°C To +85°C		
Storage Temperature	-40°C To +85°C		

Note:

1. 1/10 Duty Cycle, 0.1ms Pulse Width.

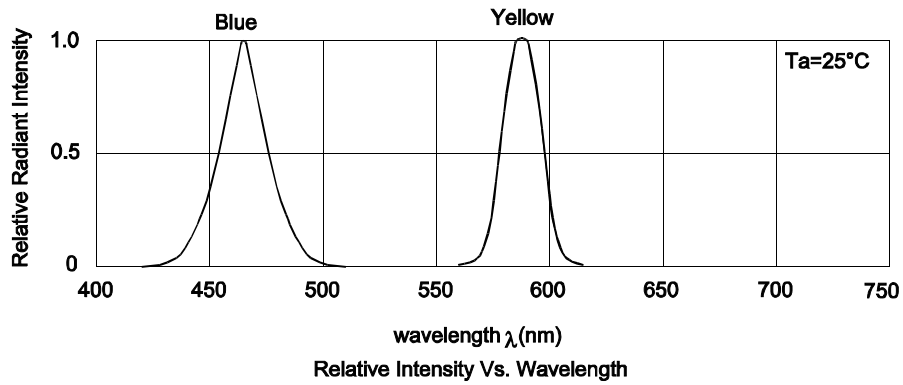

APBD3224LVBDSYKJ3C
Blue

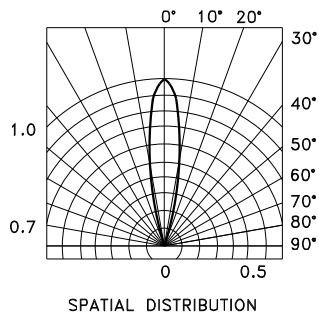
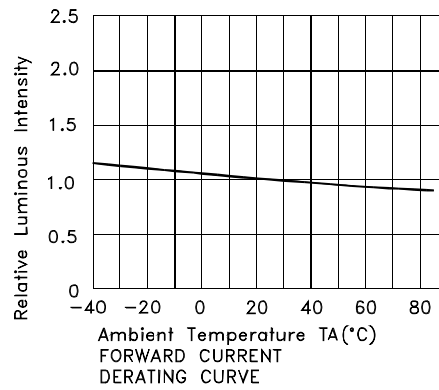
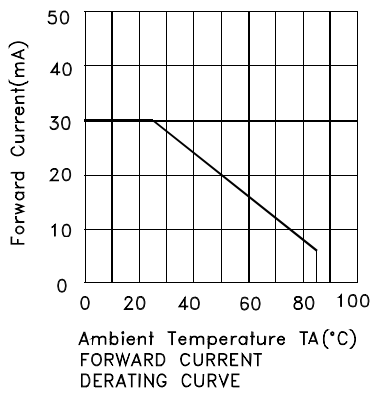
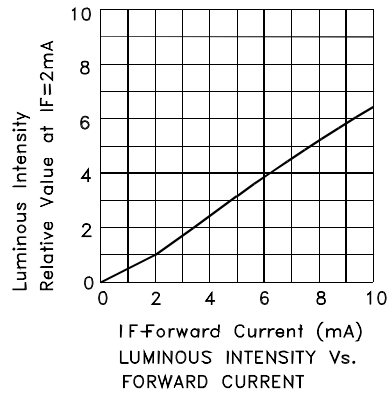
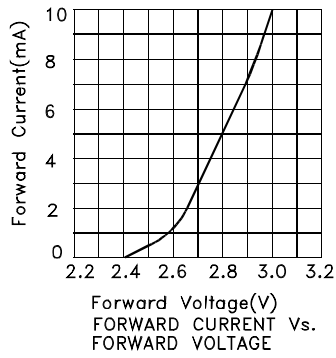

Super Bright Yellow

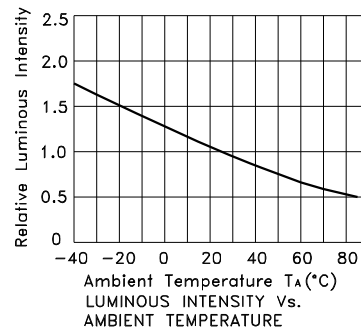
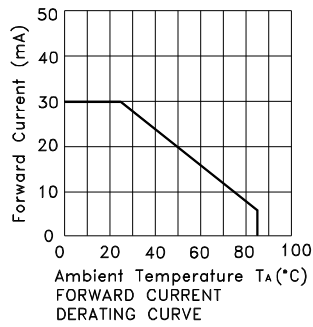
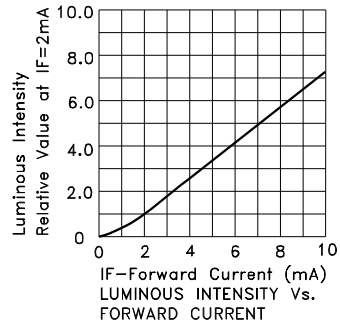
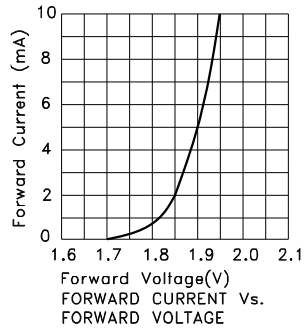

APBD3224LVBDSYKJ3C

Reflow soldering is recommended and the soldering profile is shown below.
Other soldering methods are not recommended as they might cause damage to the product.

Reflow Soldering Profile For Lead-free SMT Process.



NOTES:

1. We recommend the reflow temperature 245°C (+/-5°C). The maximum soldering temperature should be limited to 260°C.
2. Don't cause stress to the epoxy resin while it is exposed to high temperature.
3. Number of reflow process shall be 2 times or less.

Recommended Soldering Pattern (Units : mm; Tolerance: ± 0.1)



Reel Dimension

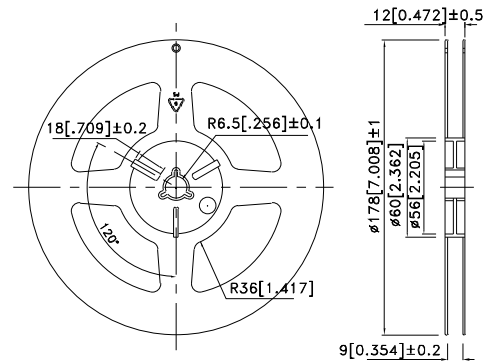

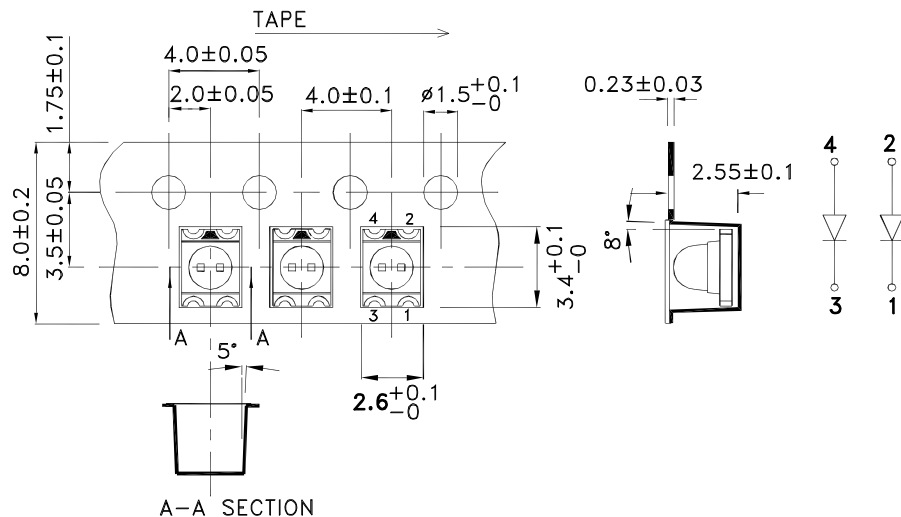

Tape Dimensions (Units : mm)

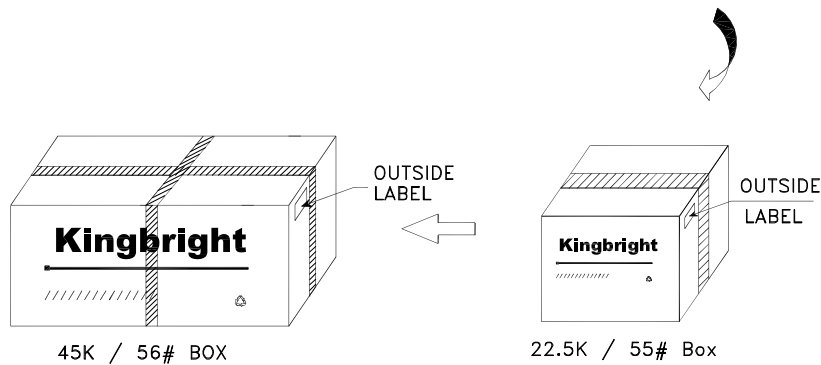
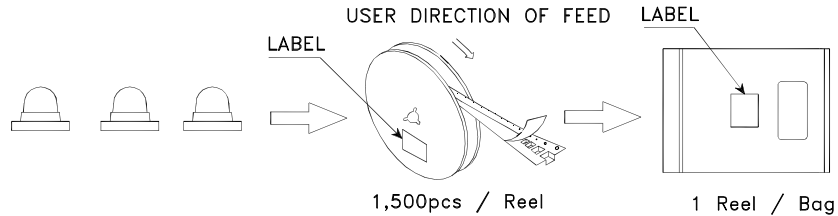

PACKING & LABEL SPECIFICATIONS

APBD3224LVBDSYKJ3C



Kingbright	
P/NO: APBD3224xxx	
QTY: 1,500 pcs	Q.C. Q C xx xx xxxx PASSED
S/N: XXXX	
CODE: XXX	
LOT NO:	
 <small>xxxxxxxxxxxxxxxxxxxxxxxxxxxx</small>	
RoHS Compliant	

Terms and conditions for the usage of this document

1. The information included in this document reflects representative usage scenarios and is intended for technical reference only.
2. The part number, type, and specifications mentioned in this document are subject to future change and improvement without notice. Before production usage customer should refer to the latest datasheet for the updated specifications.
3. When using the products referenced in this document, please make sure the product is being operated within the environmental and electrical limits specified in the datasheet. If customer usage exceeds the specified limits, Kingbright will not be responsible for any subsequent issues.
4. The information in this document applies to typical usage in consumer electronics applications. If customer's application has special reliability requirements or have life-threatening liabilities, such as automotive or medical usage, please consult with Kingbright representative for further assistance.
5. The contents and information of this document may not be reproduced or re-transmitted without permission by Kingbright.
6. All design applications should refer to Kingbright application notes available at <http://www.KingbrightUSA.com/ApplicationNotes>

Компания «Океан Электроники» предлагает заключение долгосрочных отношений при поставках импортных электронных компонентов на взаимовыгодных условиях!

Наши преимущества:

- Поставка оригинальных импортных электронных компонентов напрямую с производств Америки, Европы и Азии, а так же с крупнейших складов мира;
- Широкая линейка поставок активных и пассивных импортных электронных компонентов (более 30 млн. наименований);
- Поставка сложных, дефицитных, либо снятых с производства позиций;
- Оперативные сроки поставки под заказ (от 5 рабочих дней);
- Экспресс доставка в любую точку России;
- Помощь Конструкторского Отдела и консультации квалифицированных инженеров;
- Техническая поддержка проекта, помощь в подборе аналогов, поставка прототипов;
- Поставка электронных компонентов под контролем ВП;
- Система менеджмента качества сертифицирована по Международному стандарту ISO 9001;
- При необходимости вся продукция военного и аэрокосмического назначения проходит испытания и сертификацию в лаборатории (по согласованию с заказчиком);
- Поставка специализированных компонентов военного и аэрокосмического уровня качества (Xilinx, Altera, Analog Devices, Intersil, Interpoint, Microsemi, Actel, Aeroflex, Peregrine, VPT, Syfer, Eurofarad, Texas Instruments, MS Kennedy, Miteq, Cobham, E2V, MA-COM, Hittite, Mini-Circuits, General Dynamics и др.);

Компания «Океан Электроники» является официальным дистрибьютором и эксклюзивным представителем в России одного из крупнейших производителей разъемов военного и аэрокосмического назначения «JONHON», а так же официальным дистрибьютором и эксклюзивным представителем в России производителя высокотехнологичных и надежных решений для передачи СВЧ сигналов «FORSTAR».



JONHON

«JONHON» (основан в 1970 г.)

Разъемы специального, военного и аэрокосмического назначения:

(Применяются в военной, авиационной, аэрокосмической, морской, железнодорожной, горно- и нефтедобывающей отраслях промышленности)

«FORSTAR» (основан в 1998 г.)

ВЧ соединители, коаксиальные кабели,
кабельные сборки и микроволновые компоненты:

(Применяются в телекоммуникациях гражданского и специального назначения, в средствах связи, РЛС, а так же военной, авиационной и аэрокосмической отраслях промышленности).



Телефон: 8 (812) 309-75-97 (многоканальный)

Факс: 8 (812) 320-03-32

Электронная почта: ocean@oceanchips.ru

Web: <http://oceanchips.ru/>

Адрес: 198099, г. Санкт-Петербург, ул. Калинина, д. 2, корп. 4, лит. А