

### Applications

- Commercial and military radar

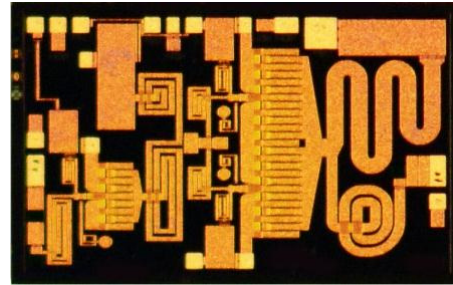

### Product Features

- Frequency Range: 2.7 – 3.7GHz
- $P_{SAT}$ : 42.8dBm at 28V
- PAE: 52%
- Small Signal Gain: 33dB
- Input Return Loss: >15dB
- Output Return Loss: >12dB
- Bias:  $V_D = 25-32V$  (CW or Pulsed),  $I_{DQ} = 225mA$ ,  $V_G = -2.5V$  Typical
- Pulsed  $V_D$ : PP = 1ms, DC = 10%
- Chip Dimensions: 3.0 x 1.9 x 0.10 mm

### Functional Block Diagram

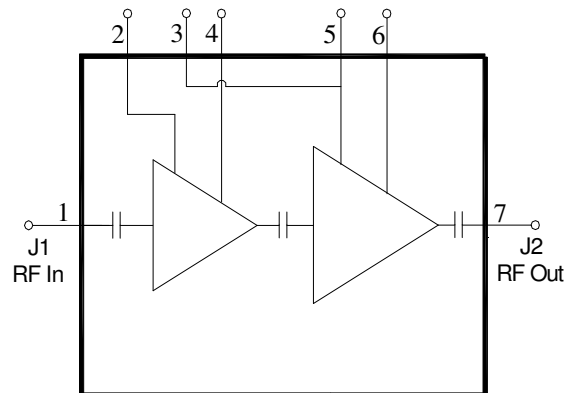

### General Description

TriQuint's TGA2585 is an S-band MMIC amplifier fabricated on TriQuint's production 0.25um GaN on SiC process (TQGaN25). Covering 2.7-3.7GHz, the TGA2585 provides 18W of saturated output power and 33dB of small signal gain while achieving 52% power-added efficiency. Higher power can be achieved at the expense of PAE by increasing the drain voltage.

The TGA2585 is ideal for phase array S-band radars and can support both short pulse and CW conditions.

Both RF ports have integrated DC blocking capacitors and are fully matched to 50ohms.

Lead-free and RoHS compliant.

### Pad Configuration

Pad No.	Symbol
1	RF In
2	$V_{G1}$
3, 5	$V_{G2}$
4	$V_{D1}$
6	$V_{D2}$
7	RF Out

### Ordering Information

Part	ECCN	Description
TGA2585	EAR99	2.7 – 3.7GHz 18W GaN Power Amplifier

### Absolute Maximum Ratings

Parameter	Value
Drain Voltage ( $V_D$ )	40V
Gate Voltage Range ( $V_G$ )	-8 to 0V
Drain Current ( $I_{D1}$ )	285mA
Drain Current ( $I_{D2}$ )	1250mA
Gate Current ( $I_{G1}$ )	-1.4 to 2.8mA
Gate Current ( $I_{G2}$ )	-4.0 to 8.4mA
Power Dissipation ( $P_{DISS}$ ), 85 °C	35W
Input Power ( $P_{IN}$ ), CW, 50 $\Omega$ , 85 °C,	30dBm
Input Power ( $P_{IN}$ ), CW, VSWR 10:1, $V_D = 28V$ , 85 °C	23dBm
Channel Temperature ( $T_{CH}$ )	275 °C
Mounting Temperature (30 Seconds)	320 °C
Storage Temperature	-55 to 150 °C

Operation of this device outside the parameter ranges given above may cause permanent damage. These are stress ratings only, and functional operation of the device at these conditions is not implied.

### Recommended Operating Conditions

Parameter	Value
Drain Voltage ( $V_D$ )	28V
Drain Current ( $I_{DQ}$ )	225mA (Total)
Gate Voltage ( $V_G$ )	-2.5V (Typ.)

Electrical specifications are measured at specified test conditions. Specifications are not guaranteed over all recommended operating conditions.

### Electrical Specifications

Test conditions unless otherwise noted: 25°C,  $V_D = 28V$ ,  $I_{DQ} = 225mA$ ,  $V_G = -2.5V$  Typical, Pulsed  $V_D$ : PP = 1ms, DC = 10%

Parameter	Min	Typical	Max	Units
Operational Frequency Range	2.7		3.7	GHz
Small Signal Gain		33		dB
Input Return Loss		>15		dB
Output Return Loss		>12		dB
Output Power ( $P_{in} = 18dBm$ )		42.8		dBm
Power Added Efficiency ( $P_{in} = 18dBm$ )		52		%
IM3 @ 25V, $P_{OUT}/tone = 30dBm$		-35		dBc
IM5 @ 25V, $P_{OUT}/tone = 30dBm$		-45		dBc
Small Signal Gain Temperature Coefficient		-0.05		dB/°C
Output Power Temperature Coefficient		-0.005		dBm/°C
Recommended Operating Voltage:		28	32	V

### Thermal and Reliability Information

Parameter	Test Conditions	Value	Units
Thermal Resistance ( $\theta_{JC}$ ) <sup>(1)</sup>	$T_{base} = 85^\circ\text{C}$ , $V_D = 28\text{V}$ , $I_{DQ} = 225\text{mA}$ <b>Pulsed <math>V_D</math>: PP = 1ms, DC = 10%</b>	2.75	$^\circ\text{C/W}$
Channel Temperature ( $T_{CH}$ ) (Under RF drive)	$T_{base} = 85^\circ\text{C}$ , $V_D = 28\text{V}$ , $I_{D\_Drive} = 1.32\text{A}$ ,	135	$^\circ\text{C}$
Median Lifetime ( $T_M$ )	$P_{IN} = 18\text{dBm}$ , $P_{OUT} = 42.7\text{dBm}$ , $P_{DISS} = 18\text{W}$	$9.75 \times 10^{10}$	Hrs
Thermal Resistance ( $\theta_{JC}$ ) <sup>(1)</sup>	$T_{base} = 85^\circ\text{C}$ , $V_D = 32\text{V}$ , $I_{DQ} = 225\text{mA}$ <b>Pulsed <math>V_D</math>: PP = 1ms, DC = 10%</b>	3.67	$^\circ\text{C/W}$
Channel Temperature ( $T_{CH}$ ) (Under RF drive)	$T_{base} = 85^\circ\text{C}$ , $V_D = 32\text{V}$ , $I_{D\_Drive} = 1.36\text{A}$ ,	169	$^\circ\text{C}$
Median Lifetime ( $T_M$ )	$P_{IN} = 18\text{dBm}$ , $P_{OUT} = 43.4\text{dBm}$ , $P_{DISS} = 23\text{W}$	$2.36 \times 10^9$	Hrs
Thermal Resistance ( $\theta_{JC}$ ) <sup>(1)</sup>	$T_{base} = 85^\circ\text{C}$ , $V_D = 28\text{V}$ , $I_{DQ} = 225\text{mA}$ , <b>CW</b>	4.96	$^\circ\text{C/W}$
Channel Temperature ( $T_{CH}$ ) (Under RF drive)	$T_{base} = 85^\circ\text{C}$ , $V_D = 28\text{V}$ , $I_{D\_Drive} = 1.17\text{A}$ ,	167	$^\circ\text{C}$
Median Lifetime ( $T_M$ )	$P_{IN} = 18\text{dBm}$ , $P_{OUT} = 42\text{dBm}$ , $P_{DISS} = 16.5\text{W}$	$2.89 \times 10^8$	Hrs
Thermal Resistance ( $\theta_{JC}$ ) <sup>(1)</sup>	$T_{base} = 85^\circ\text{C}$ , $V_D = 32\text{V}$ , $I_{DQ} = 225\text{mA}$ , <b>CW</b>	5.86	$^\circ\text{C/W}$
Channel Temperature ( $T_{CH}$ ) (Under RF drive)	$T_{base} = 85^\circ\text{C}$ , $V_D = 32\text{V}$ , $I_{D\_Drive} = 1.23\text{A}$ ,	208	$^\circ\text{C}$
Median Lifetime ( $T_M$ )	$P_{IN} = 18\text{dBm}$ , $P_{OUT} = 42.7\text{dBm}$ , $P_{DISS} = 20.9\text{W}$	$6.34 \times 10^6$	Hrs

Notes:

1. Thermal resistance measured to back of carrier plate. MMIC mounted on 40 mils CuMo (80/20) carrier using 1.5 mil AuSn.

### Median Lifetime

Test Conditions:  $V_D = 40\text{V}$ ; Failure Criteria = 10% reduction in  $I_{D\_MAX}$

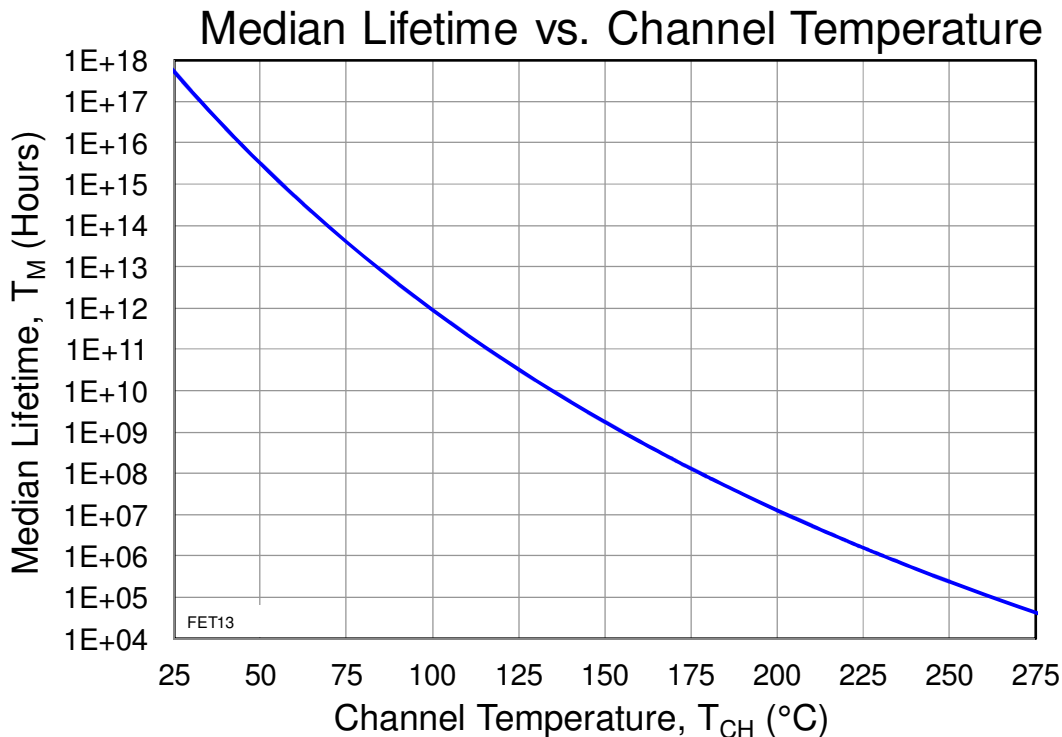

**Typical Performance (Small Signal)**

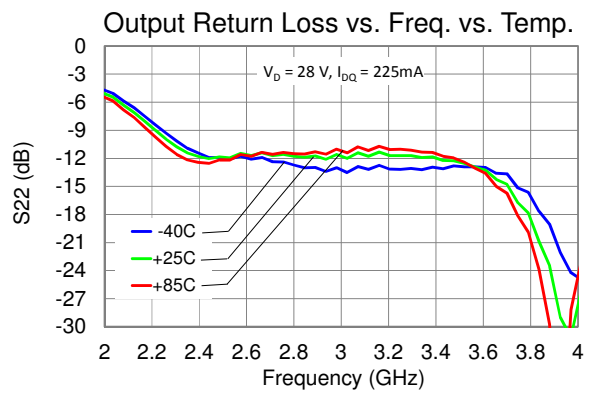
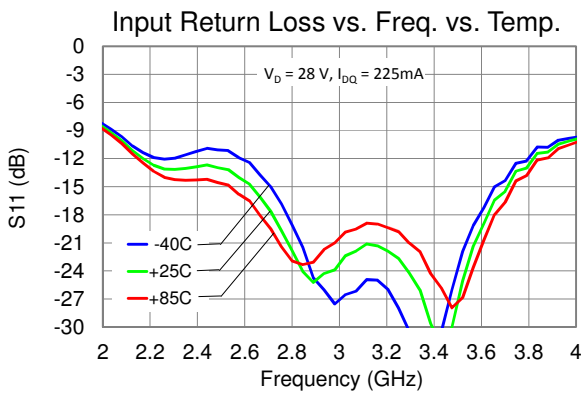
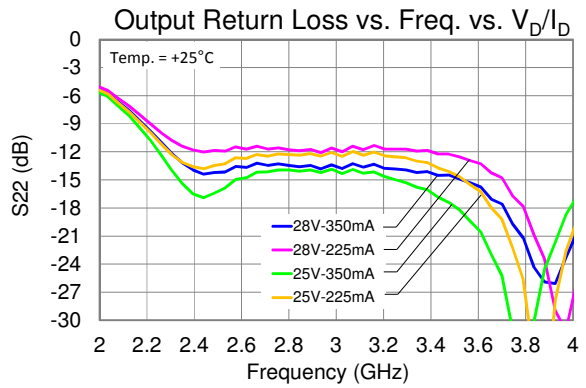
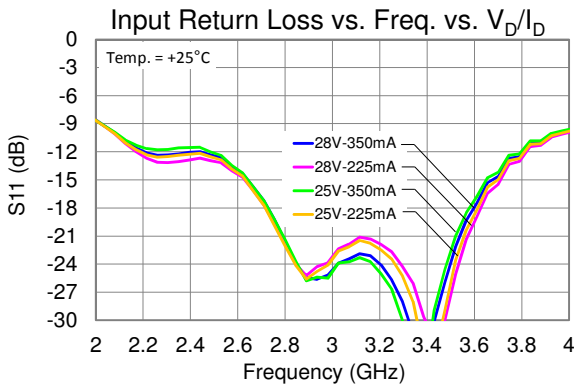
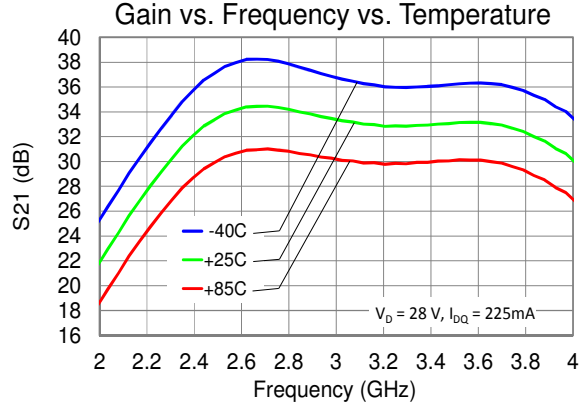
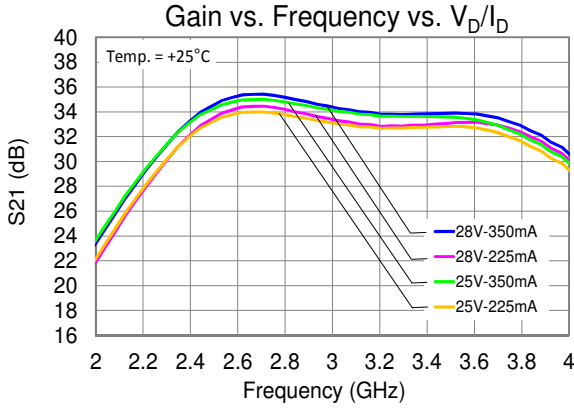

### Typical Performance (Pulsed Operation)

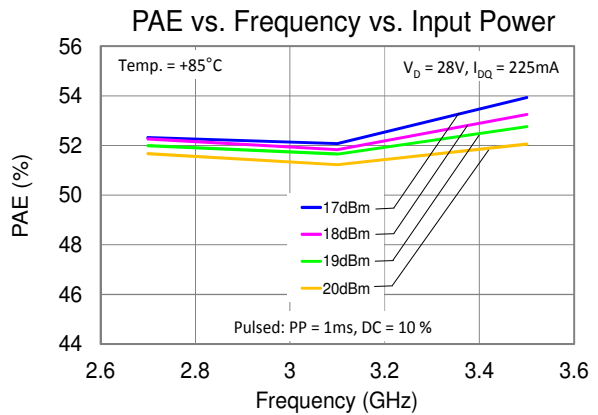
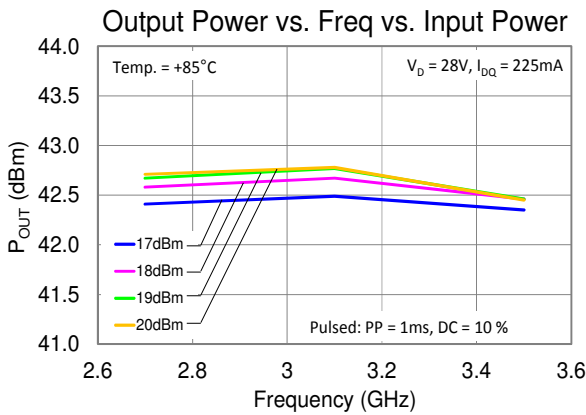
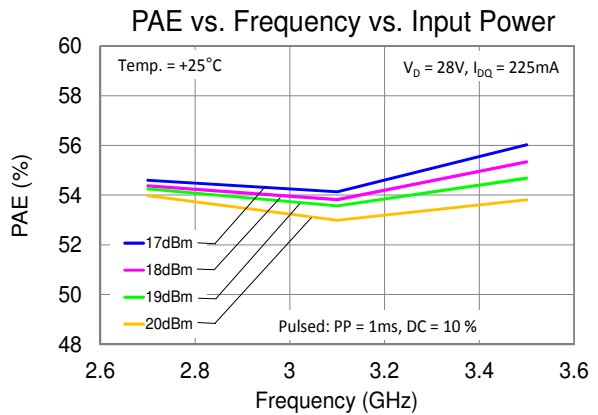
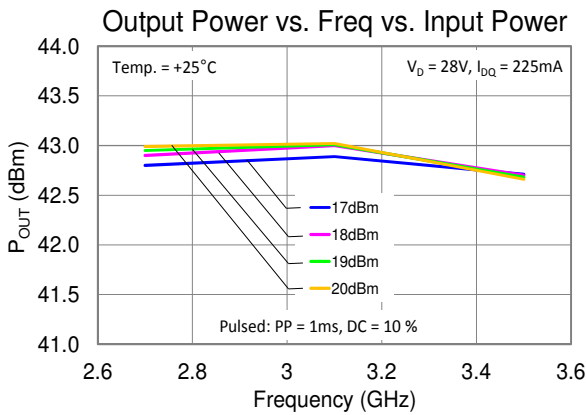
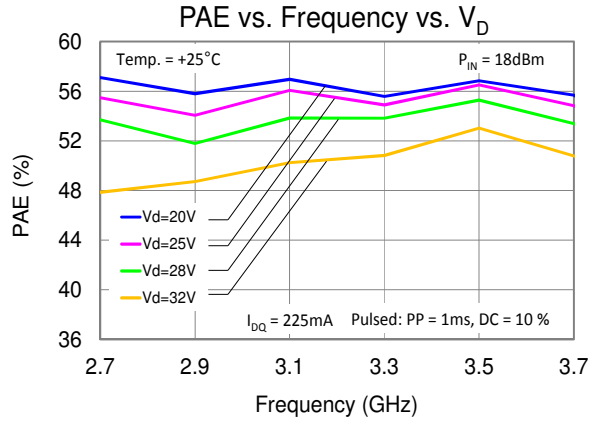
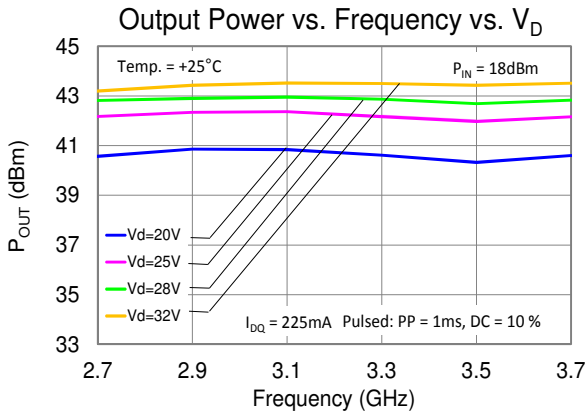

### Typical Performance (Pulsed Operation)

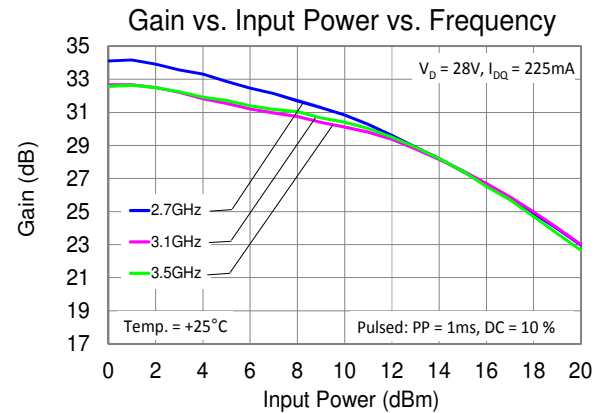
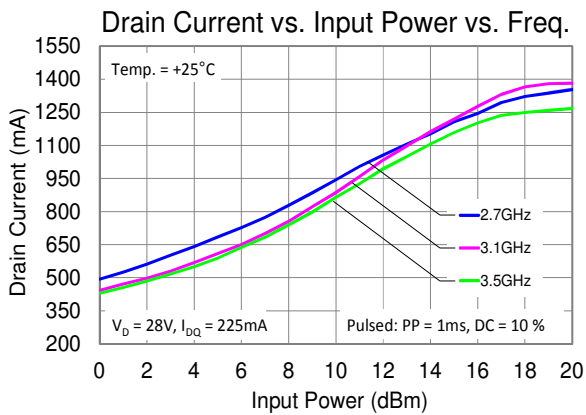
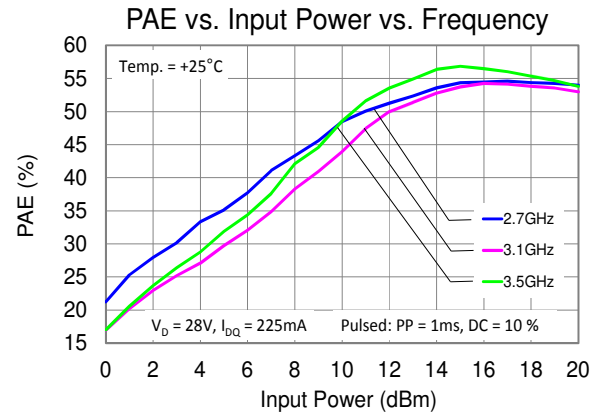
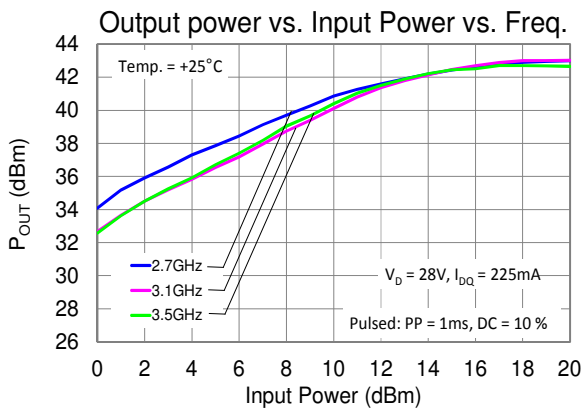
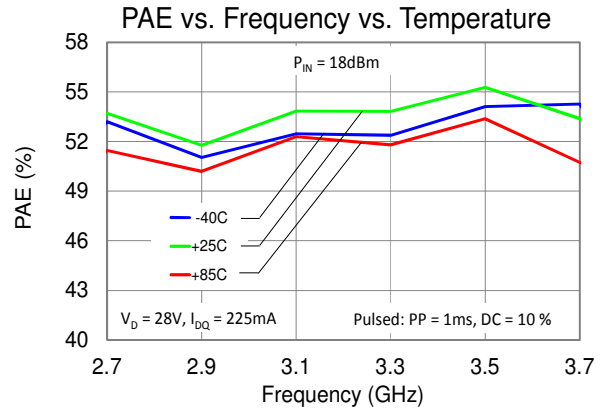
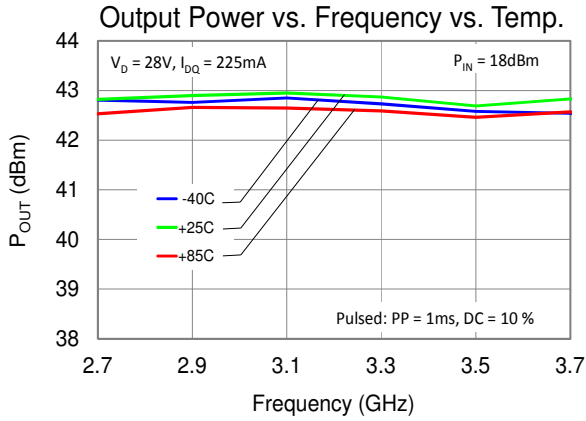

**Typical Performance (CW Operation)**

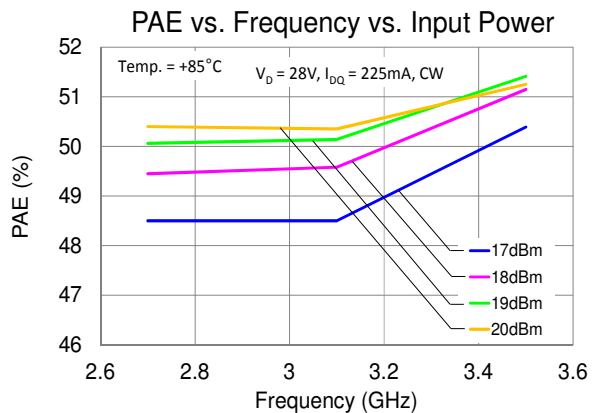
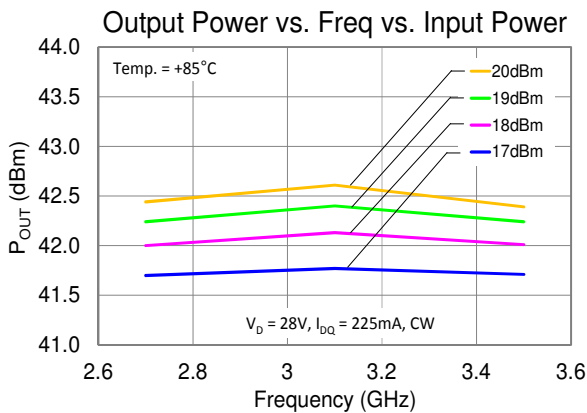
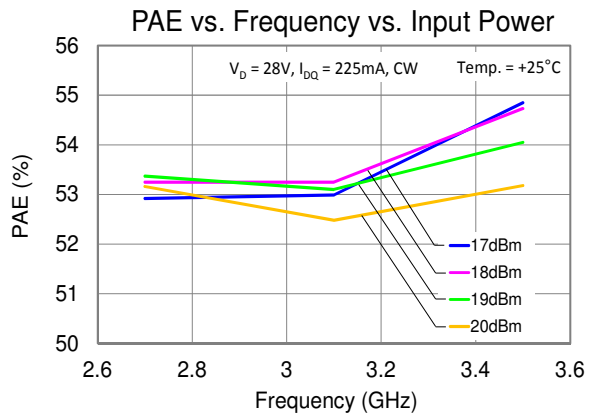
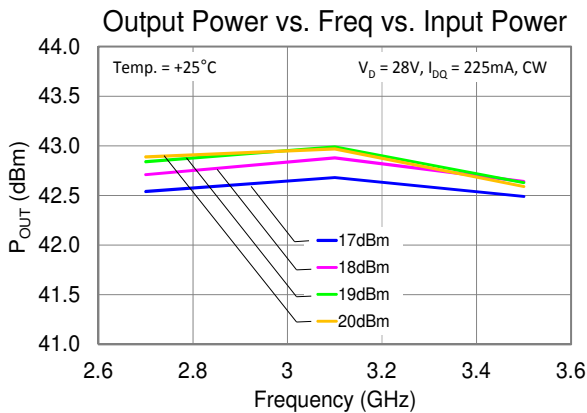
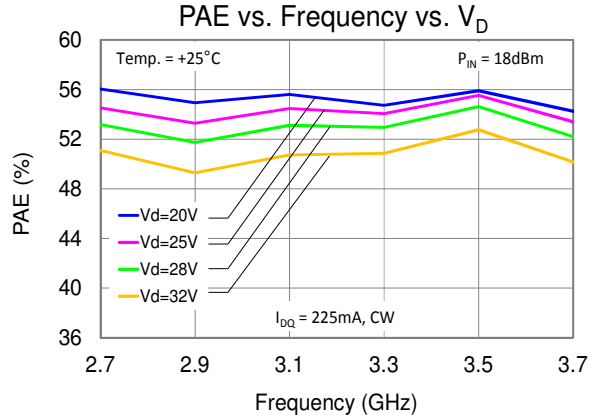
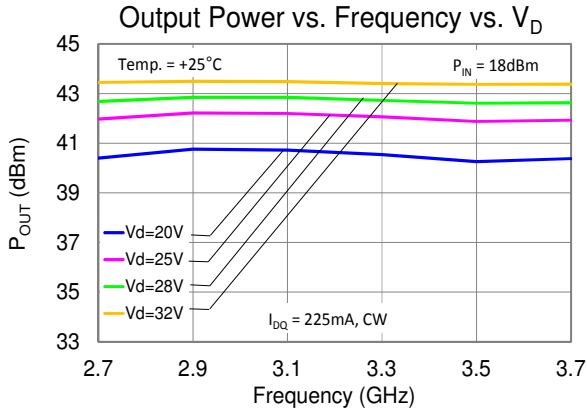

**Typical Performance**

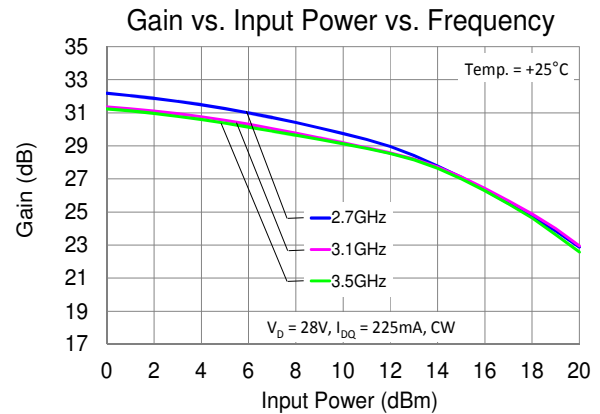
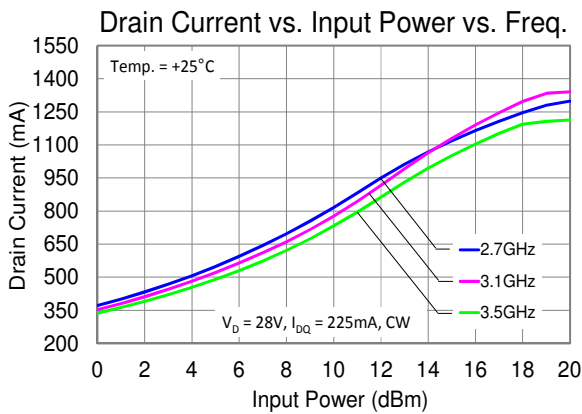
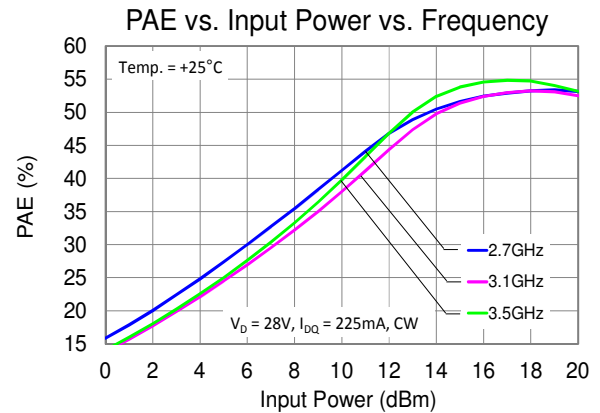
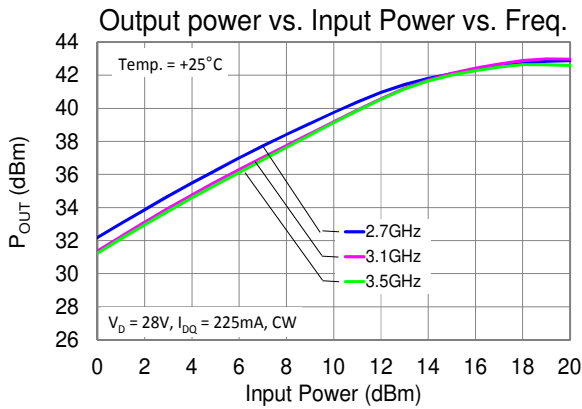
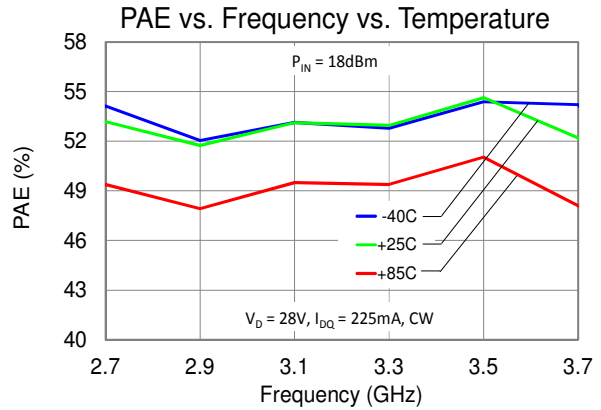
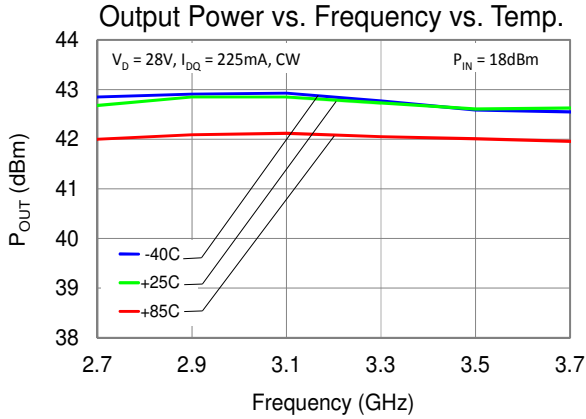



**Typical Performance (Linearity)**

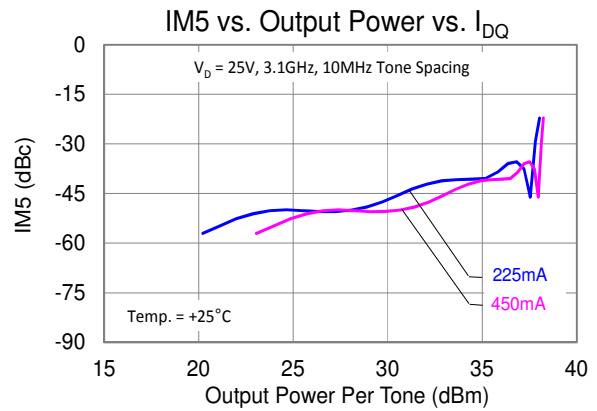
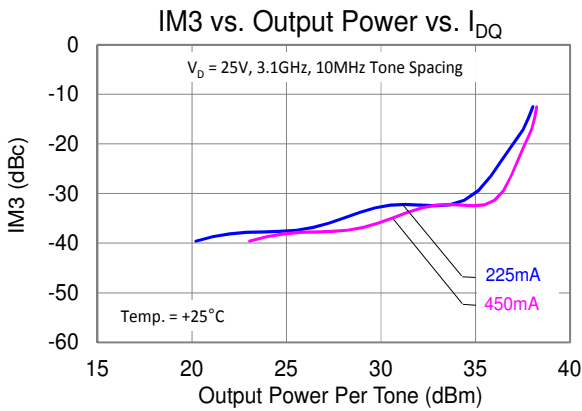
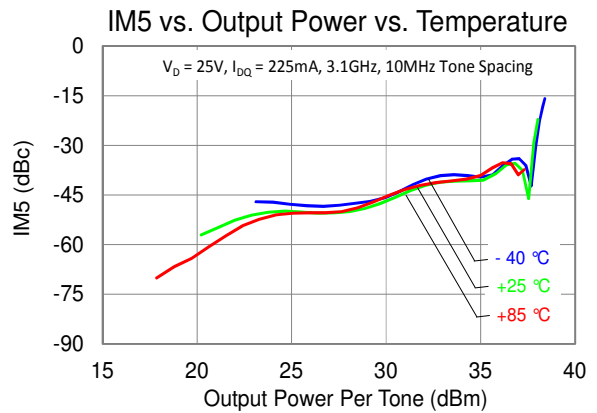
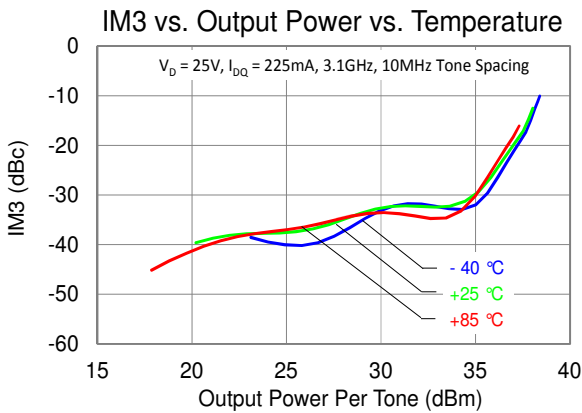
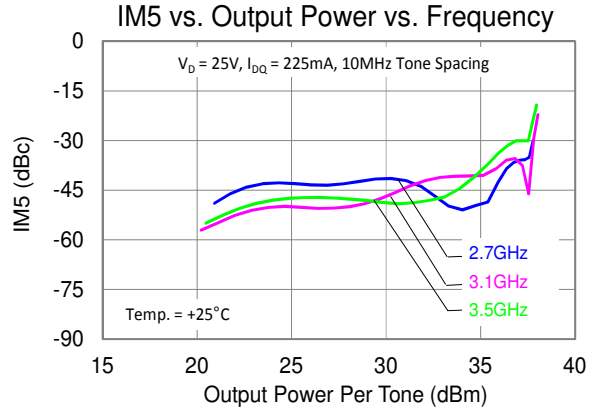
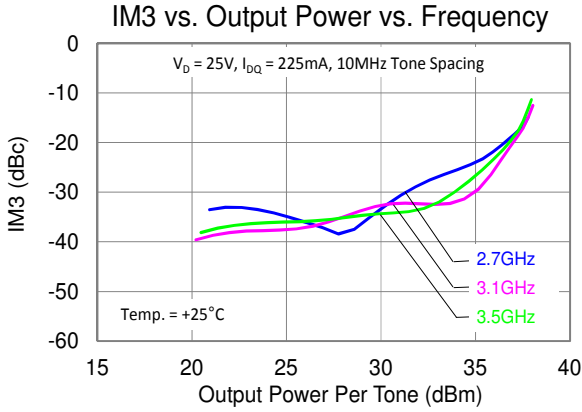

**Typical Performance (Linearity)**

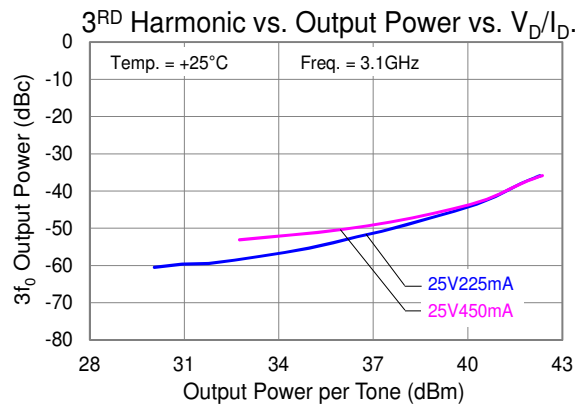
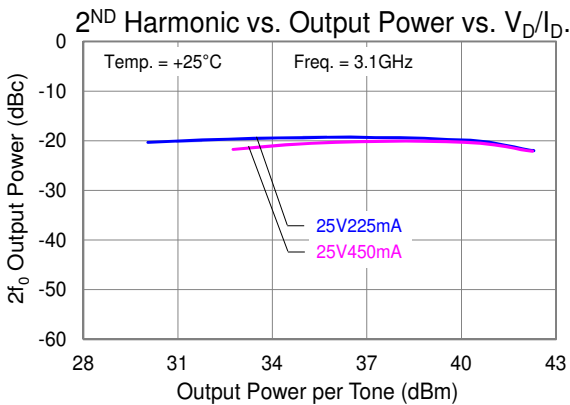
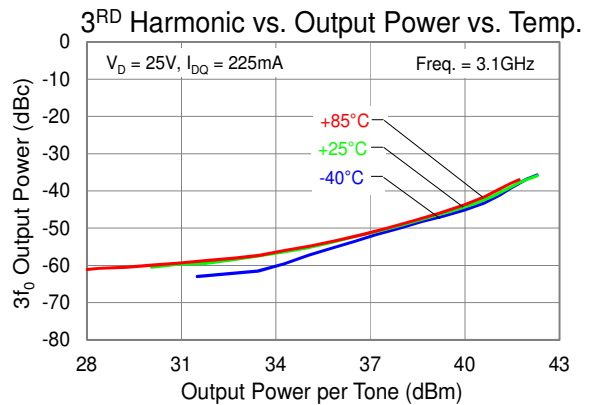
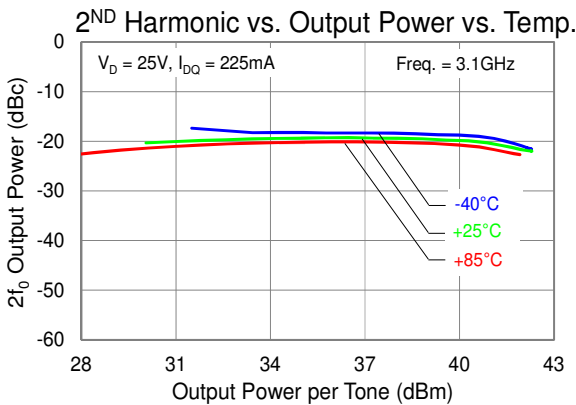
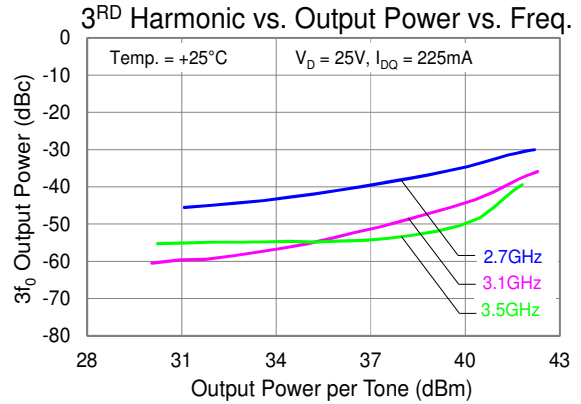
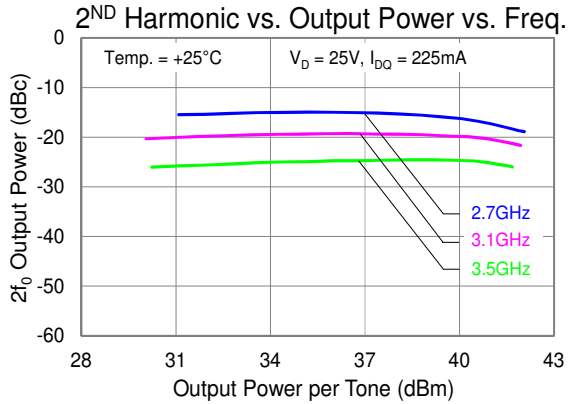

**Application Circuit**

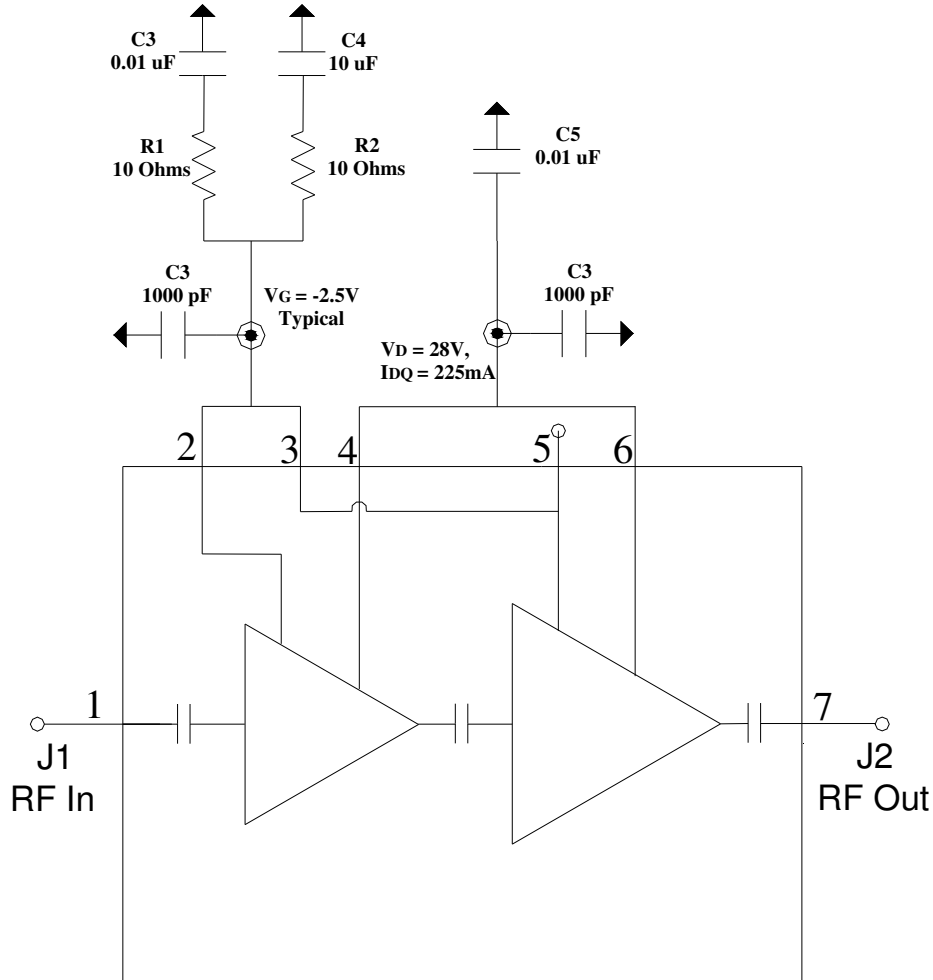

**Bias-up Procedure**

1. Set  $I_D$  limit to 1.5A,  $I_G$  limit to 8mA
2. Apply -5.0V to  $V_G$
3. Apply +28V to  $V_D$
4. Adjust  $V_G$  more positive until  $I_{DQ} = 225\text{mA}$  ( $V_G \sim -2.5\text{V}$  Typical)
5. Apply RF signal

**Bias-down Procedure**

1. Turn off RF signal
2. Reduce  $V_G$  to -5.0V. Ensure  $I_{DQ} \sim 0\text{mA}$
3. Set  $V_D$  to 0V
4. Turn off  $V_D$  supply
5. Turn off  $V_G$  supply

**Assembly Drawing**

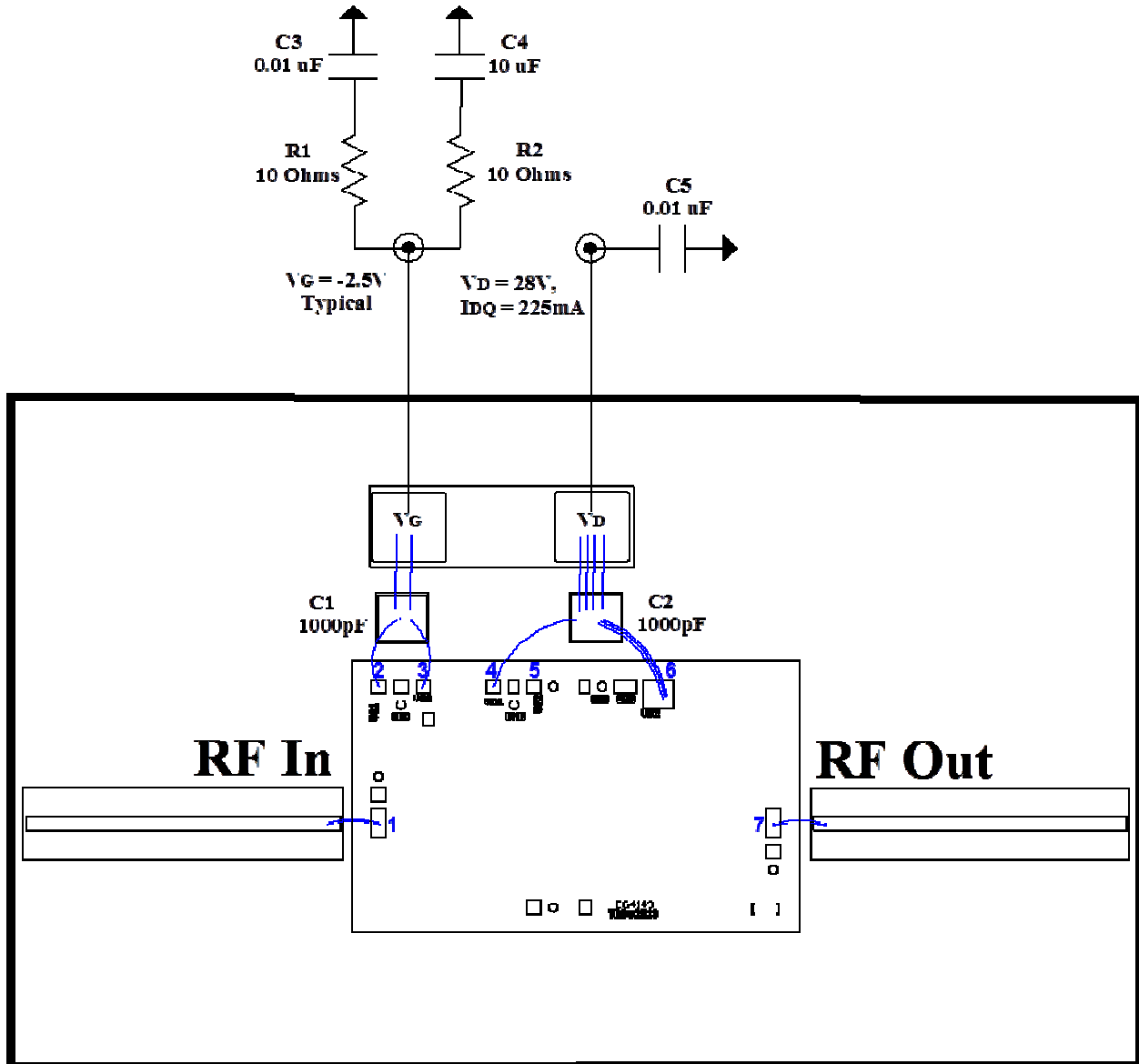

### Mechanical Drawing & Bond Pad Description

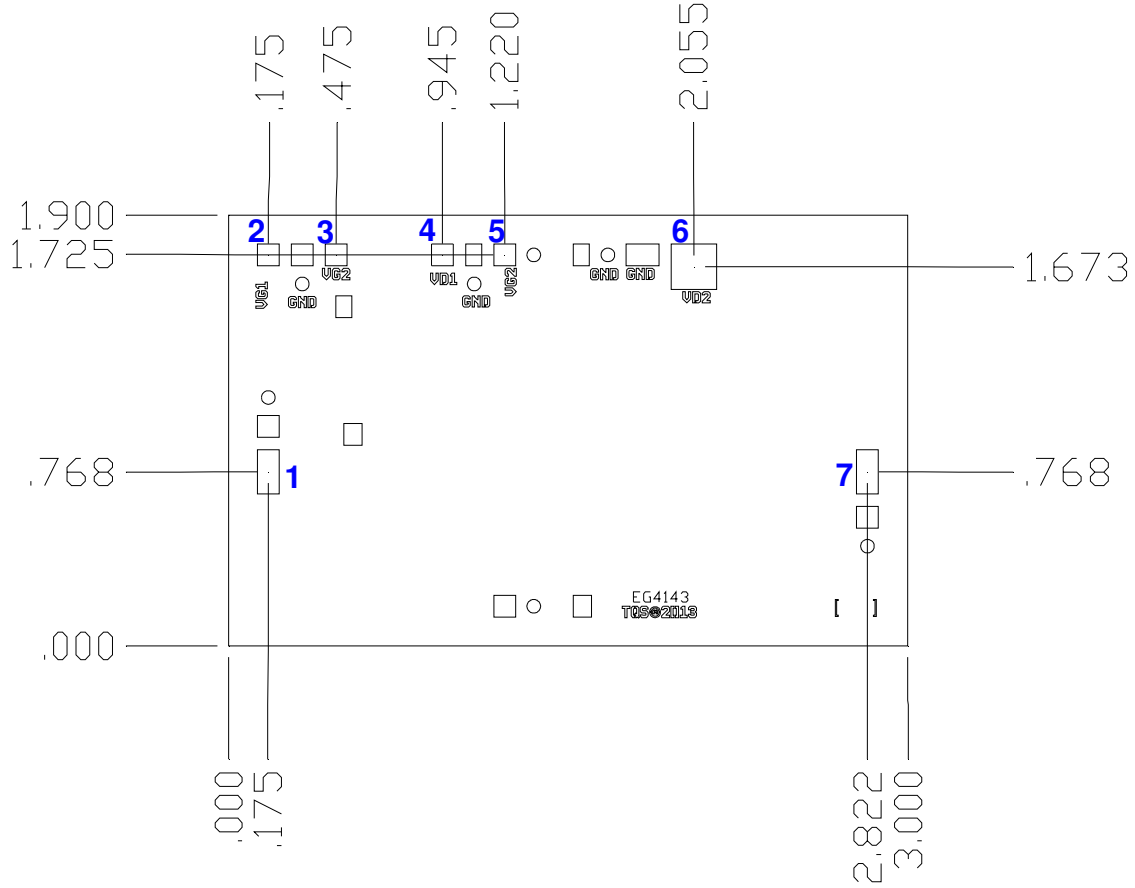

Unit: millimeters  
 Thickness: 0.10  
 Die x, y size tolerance: +/- 0.050  
 Chip edge to bond pad dimensions are shown to center of pad  
 Ground is backside of die

Bond Pad	Symbol	Pad Size	Description
1	RF In	0.096 x 0.196	Input; matched to 50 ohms; DCblocked
2	V <sub>G1</sub>	0.096 x 0.096	Gate voltage 1; bias network is required; see Application Circuit on page 11 as an example
3, 5	V <sub>G2</sub>	0.096 x 0.096	Gate voltage 2; bias network is required; see Application Circuit on page 11 as an example. Can be biased on either pad
4	V <sub>D1</sub>	0.096 x 0.096	Drain voltage ; bias network is required; see Application Circuit on page 11 as an example
6	V <sub>D2</sub>	0.200 x 0.200	Drain voltage 2; bias network is required; see Application Circuit on page 11 as an example
7	RF Out	0.096 x 0.196	Output; matched to 50 ohms; DC blocked

## Assembly Notes

Component placement and adhesive attachment assembly notes:

- Vacuum pencils and/or vacuum collets are the preferred method of pick up.
- Air bridges must be avoided during placement.
- The force impact is critical during auto placement.
- Organic attachment (i.e. epoxy) can be used in low-power applications.
- Curing should be done in a convection oven; proper exhaust is a safety concern.

Reflow process assembly notes:

- Use AuSn (80/20) solder and limit exposure to temperatures above 300°C to 3-4 minutes, maximum.
- An alloy station or conveyor furnace with reducing atmosphere should be used.
- Do not use any kind of flux.
- Coefficient of thermal expansion matching is critical for long-term reliability.
- Devices must be stored in a dry nitrogen atmosphere.

Interconnect process assembly notes:

- Thermosonic ball bonding is the preferred interconnect technique.
- Force, time, and ultrasonic are critical parameters.
- Aluminum wire should not be used.
- Devices with small pad sizes should be bonded with 0.0007-inch wire.

### Product Compliance Information

#### ESD Sensitivity Ratings



Caution! ESD-Sensitive Device

ESD Rating: TBD  
Value: TBD  
Test: Human Body Model (HBM)  
Standard: JEDEC Standard JESD22-A114

#### ECCN

US Department of Commerce: EAR99

#### Solderability

Use only AuSn (80/20) solder and limit exposure to temperatures above 300 °C to 3-4 minutes, maximum.

#### RoHS-Compliance

This part is compliant with EU 2002/95/EC RoHS directive (Restrictions on the Use of Certain Hazardous Substances in Electrical and Electronic Equipment).

This product also has the following attributes:

- Lead Free
- Halogen Free (Chlorine, Bromine)
- Antimony Free
- TBBP-A (C<sub>15</sub>H<sub>12</sub>Br<sub>4</sub>O<sub>2</sub>) Free
- PFOS Free
- SVHC Free

### Contact Information

For the latest specifications, additional product information, worldwide sales and distribution locations, and information about TriQuint:

Web: [www.triquint.com](http://www.triquint.com)  
Email: [info-sales@triquint.com](mailto:info-sales@triquint.com)

Tel: +1.972.994.8465  
Fax: +1.972.994.8504

For technical questions and application information: Email: [info-products@triquint.com](mailto:info-products@triquint.com)

### Important Notice

The information contained herein is believed to be reliable. TriQuint makes no warranties regarding the information contained herein. TriQuint assumes no responsibility or liability whatsoever for any of the information contained herein. TriQuint assumes no responsibility or liability whatsoever for the use of the information contained herein. The information contained herein is provided "AS IS, WHERE IS" and with all faults, and the entire risk associated with such information is entirely with the user. All information contained herein is subject to change without notice. Customers should obtain and verify the latest relevant information before placing orders for TriQuint products. The information contained herein or any use of such information does not grant, explicitly or implicitly, to any party any patent rights, licenses, or any other intellectual property rights, whether with regard to such information itself or anything described by such information.

TriQuint products are not warranted or authorized for use as critical components in medical, life-saving, or life-sustaining applications, or other applications where a failure would reasonably be expected to cause severe personal injury or death.

Компания «Океан Электроники» предлагает заключение долгосрочных отношений при поставках импортных электронных компонентов на взаимовыгодных условиях!

Наши преимущества:

- Поставка оригинальных импортных электронных компонентов напрямую с производств Америки, Европы и Азии, а так же с крупнейших складов мира;
- Широкая линейка поставок активных и пассивных импортных электронных компонентов (более 30 млн. наименований);
- Поставка сложных, дефицитных, либо снятых с производства позиций;
- Оперативные сроки поставки под заказ (от 5 рабочих дней);
- Экспресс доставка в любую точку России;
- Помощь Конструкторского Отдела и консультации квалифицированных инженеров;
- Техническая поддержка проекта, помощь в подборе аналогов, поставка прототипов;
- Поставка электронных компонентов под контролем ВП;
- Система менеджмента качества сертифицирована по Международному стандарту ISO 9001;
- При необходимости вся продукция военного и аэрокосмического назначения проходит испытания и сертификацию в лаборатории (по согласованию с заказчиком);
- Поставка специализированных компонентов военного и аэрокосмического уровня качества (Xilinx, Altera, Analog Devices, Intersil, Interpoint, Microsemi, Actel, Aeroflex, Peregrine, VPT, Syfer, Eurofarad, Texas Instruments, MS Kennedy, Miteq, Cobham, E2V, MA-COM, Hittite, Mini-Circuits, General Dynamics и др.);

Компания «Океан Электроники» является официальным дистрибьютором и эксклюзивным представителем в России одного из крупнейших производителей разъемов военного и аэрокосмического назначения «JONHON», а так же официальным дистрибьютором и эксклюзивным представителем в России производителя высокотехнологичных и надежных решений для передачи СВЧ сигналов «FORSTAR».



## JONHON

«JONHON» (основан в 1970 г.)

Разъемы специального, военного и аэрокосмического назначения:

(Применяются в военной, авиационной, аэрокосмической, морской, железнодорожной, горно- и нефтедобывающей отраслях промышленности)

«FORSTAR» (основан в 1998 г.)

ВЧ соединители, коаксиальные кабели, кабельные сборки и микроволновые компоненты:

(Применяются в телекоммуникациях гражданского и специального назначения, в средствах связи, РЛС, а так же военной, авиационной и аэрокосмической отраслях промышленности).



Телефон: 8 (812) 309-75-97 (многоканальный)

Факс: 8 (812) 320-03-32

Электронная почта: [ocean@oceanchips.ru](mailto:ocean@oceanchips.ru)

Web: <http://oceanchips.ru/>

Адрес: 198099, г. Санкт-Петербург, ул. Калинина, д. 2, корп. 4, лит. А