

## Features

- Contactless Linear Sensor
- IP64 Debris Proof, Splash Proof
- Ideal for Hydraulic and Pneumatic Position Sensing
- Liquid Level Capability
- Upon request
  - Male or Female Nicomatic Connectors
  - Corresponding Exterior Magnet



## Mechanical Specifications

- Life Cycle: >1 million
- Height:  $\leq 3.50\text{mm}$  (0.138")
- Actuation Force: 0.09 to 0.11 lbs pull force at desired distance (pull force rating is for the exterior magnet using a test plate of cold rolled steel).

## Environmental Specifications

- Operating Temperature: up to +85°C
- IP Rating of Active Area: IP64

## Electrical Specifications

- Resistance - Standard: 10k Ohms (lengths >300mm = 20k Ohms)
- Resistance - Custom: 5k to 500k Ohms
- Resistance Tolerance:  $\pm 20\%$
- Effective Electrical Travel: 8 to 1200mm
- Resolution: Depends on the exterior magnet strength and distance to the Magnetopot
- Power Rating: 0.50 Watt continuous, 1 Watt Peak
- Dielectric Value: No affect @ 500VAC for 1 minute
- Independant Linearity:  $\pm 5\%$  ( $\pm 1\%$  available)
- Hysteresis: 3mm\*

*\*Please note that the hysteresis is directly affected by the drive magnet size, strength, and distance from the internal magnet.*

## Dimensional Diagram - Stock Linear Magnetopots

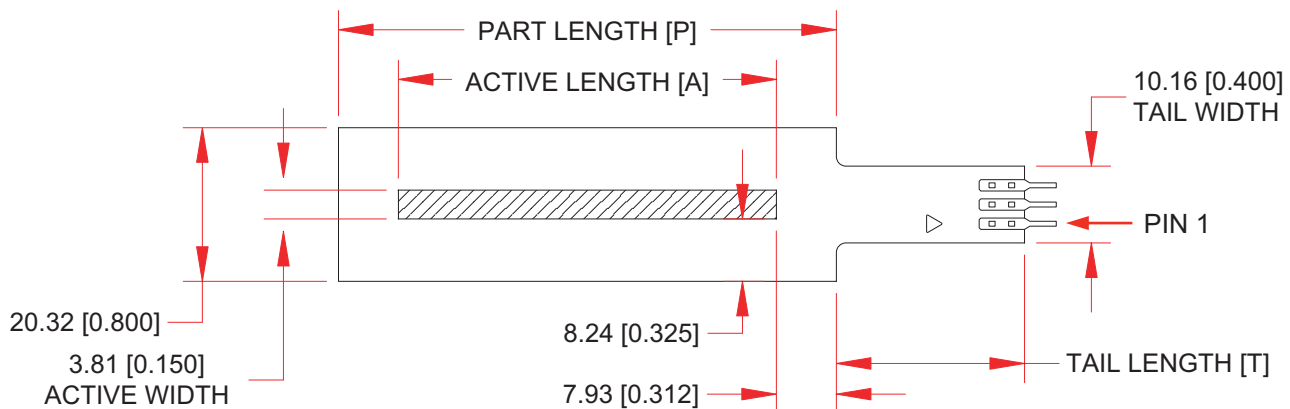

|   |                   |                   |                   |                    |                    |                    |                    |                     |                     |                     |                     |                      |
|---|-------------------|-------------------|-------------------|--------------------|--------------------|--------------------|--------------------|---------------------|---------------------|---------------------|---------------------|----------------------|
| A | 12.50mm<br>0.492" | 25.00mm<br>0.984" | 50.00mm<br>1.969" | 100.00mm<br>3.937" | 150.00mm<br>5.906" | 171.89mm<br>6.768" | 200.00mm<br>7.874" | 300.00mm<br>11.811" | 400.00mm<br>15.748" | 500.00mm<br>19.685" | 750.00mm<br>29.528" | 1000.00mm<br>39.370" |
| P | 28.36mm<br>1.117" | 40.86mm<br>1.609" | 65.86mm<br>2.593" | 115.86mm<br>4.562" | 165.86mm<br>6.531" | 185.86mm<br>7.318" | 215.86mm<br>8.499" | 315.86mm<br>12.436" | 415.86mm<br>16.373" | 515.86mm<br>20.310" | 765.86mm<br>30.153" | 1015.86mm<br>39.995" |
| T | 12.70mm<br>0.500" |                   |                   |                    |                    |                    |                    |                     |                     |                     |                     | 24.89mm<br>0.980"    |

## Electrical Schematic

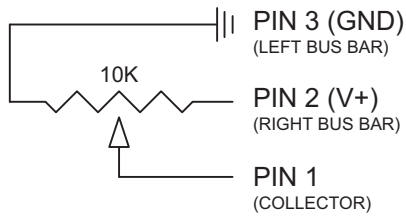

## Material Cross-Section

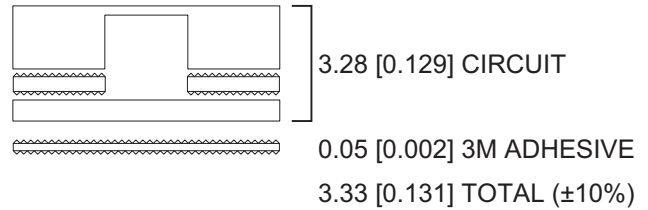

## How to Order - MagnetoPots

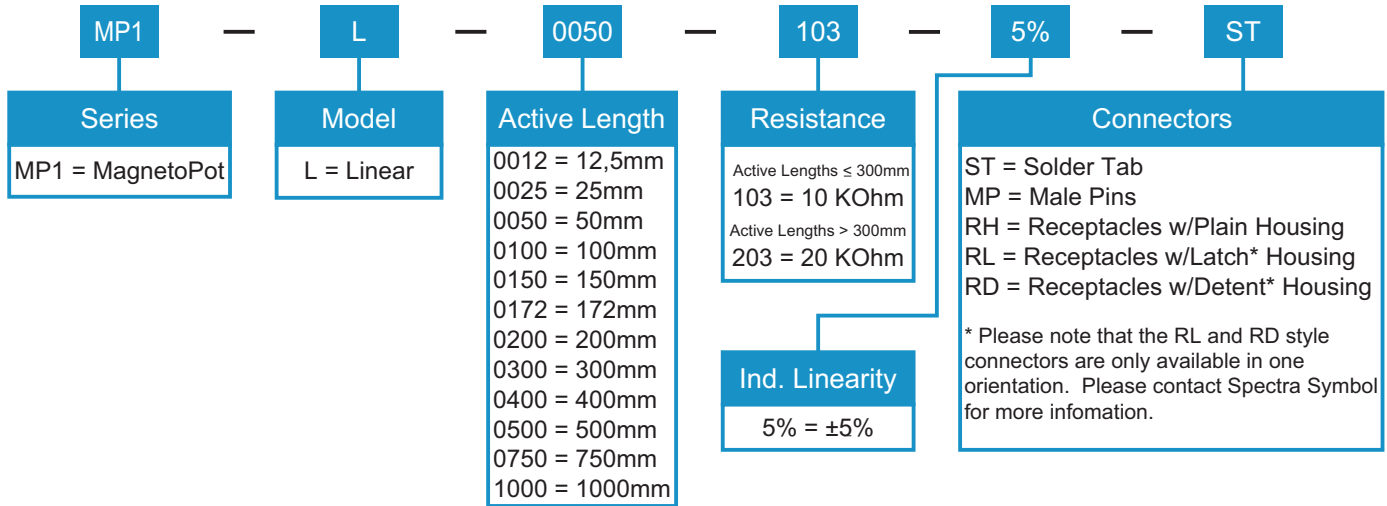

## Standard Connector Options

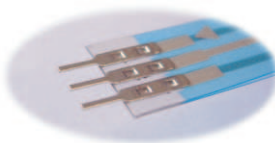

Crimpflex Solder Tab (ST)



Crimpflex Short Male Pins (MP)



Crimpflex Female Receptacles with a Plain Housing (RH)



Crimpflex Female Receptacles with a Latch Housing (RL)

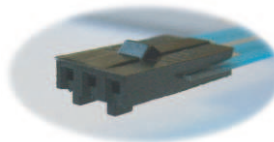

Crimpflex Female Receptacles with a Detent Housing (RD)

## Customization

Customize the size and shape. Such custom requests, for example, can be: custom lengths 10mm-1200mm; custom rotary diameters, etc. Spectra Symbol would be glad to quote your custom application, just contact us at [sales@spectrasymbol.com](mailto:sales@spectrasymbol.com) or (888)795-2283.

## How It Works

The MagnetoPot is simple, yet elegant in its ability to track motion in a contactless manner. A magnet on the inside of a cylinder, or a magnet on the opposing side of a motion device will guide the built-in magnetics of the MagnetoPot for position location through a potentiometric output.

The MagnetoPot is a sealed potentiometer, in the membrane potentiometer tradition, yet it does not require a wiper/actuator to connect the collector and the resistor. Instead, the MagnetoPot is controlled by an outside magnet, which attracts the magnetic forces within the MagnetoPot to connect to the linear resistor and give linear potentiometer feedback.

The wiper inside the sealed pot is magnetic or ferromagnetic, and will only perform if connected with an exterior magnet.

As opposed to a magnetically-based Reed Switch, which gives simply “open” or “close” signals, the MagnetoPot gives the full linear travel of a hydraulic or pneumatic cylinder.

In liquid level applications, the MagnetoPot can attach to the outside of a liquid tank and give position of the magnet inside the float. No water ingress, no wearing of the part by environment, because the MagnetoPot is outside of the tank.

## Design and Construction

The MagnetoPot is made of polyester, fiberglass and kapton, depending on the specification required. It functions as a voltage divider, a resistor or rheostat, as desired by the end-user. By bringing the exterior magnet into a proximity necessary to connect with the internal magnetic attractors, the operator can obtain linear position sensing based on the location of the exterior magnet. As the exterior magnet moves, so does the electrical output of the MagnetoPot.

The MagnetoPot should not be mounted to a ferromagnetic surface.

Diagram - Stock Rotary MagnetoPot

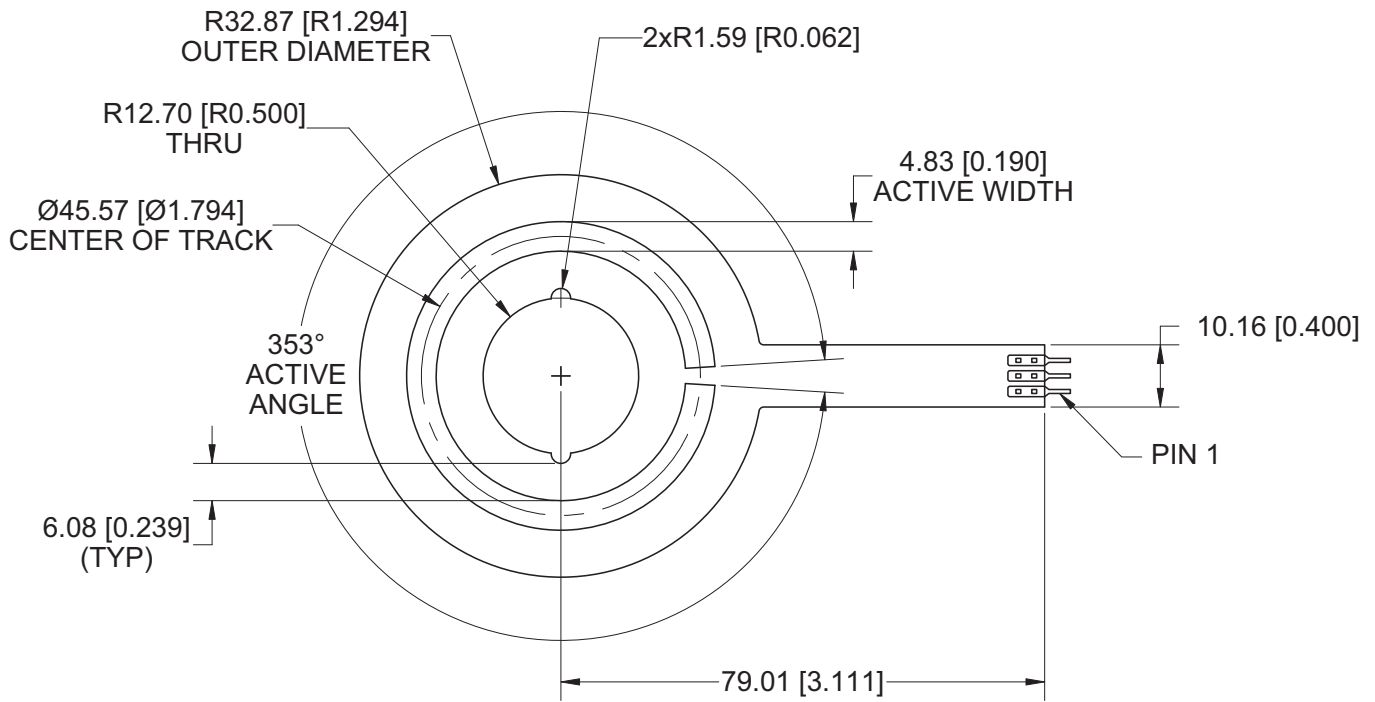

Electrical Schematic

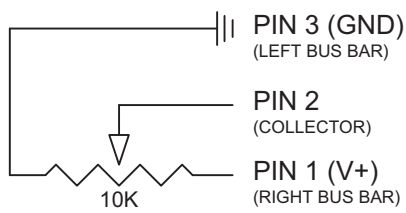

Material Cross-Section

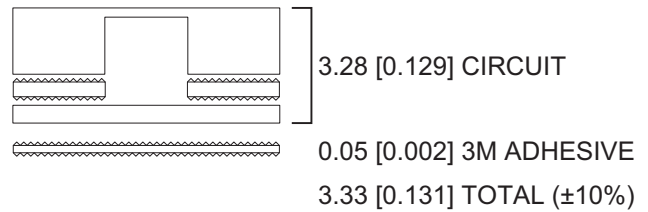

How to Order - Rotary MagnetoPot

|                  |   |              |   |                               |   |                     |   |                       |   |  |   |           |
|------------------|---|--------------|---|-------------------------------|---|---------------------|---|-----------------------|---|--|---|-----------|
| <b>MP1</b>       | — | <b>R</b>     | — | <b>0046</b>                   | / | <b>0353</b>         | — | <b>103</b>            | — | <b>5%</b>  | — | <b>ST</b> |
| <b>Series</b>    |   | <b>Model</b> |   | <b>Center of Active Track</b> |   | <b>Active Angle</b> |   | <b>Resistance</b>     |   | <b>Connectors</b>  |   |           |
| MP1 = MagnetoPot |   | R = Rotary   |   | 0046 = 45.57mm                |   | 0353 = 353°         |   | 103 = 10 KOhm         |   | ST = Solder Tab<br>MP = Male Pins<br>RH = Receptacles w/Plain Housing<br>RL = Receptacles w/Latch Housing<br>RD = Receptacles w/Detent Housing |   |           |
|                  |   |              |   |                               |   |                     |   | <b>Ind. Linearity</b> |   |  |   |           |
|                  |   |              |   |                               |   |                     |   | 5% = ±5%              |   |  |   |           |

Компания «Океан Электроники» предлагает заключение долгосрочных отношений при поставках импортных электронных компонентов на взаимовыгодных условиях!

Наши преимущества:

- Поставка оригинальных импортных электронных компонентов напрямую с производств Америки, Европы и Азии, а так же с крупнейших складов мира;
- Широкая линейка поставок активных и пассивных импортных электронных компонентов (более 30 млн. наименований);
- Поставка сложных, дефицитных, либо снятых с производства позиций;
- Оперативные сроки поставки под заказ (от 5 рабочих дней);
- Экспресс доставка в любую точку России;
- Помощь Конструкторского Отдела и консультации квалифицированных инженеров;
- Техническая поддержка проекта, помощь в подборе аналогов, поставка прототипов;
- Поставка электронных компонентов под контролем ВП;
- Система менеджмента качества сертифицирована по Международному стандарту ISO 9001;
- При необходимости вся продукция военного и аэрокосмического назначения проходит испытания и сертификацию в лаборатории (по согласованию с заказчиком);
- Поставка специализированных компонентов военного и аэрокосмического уровня качества (Xilinx, Altera, Analog Devices, Intersil, Interpoint, Microsemi, Actel, Aeroflex, Peregrine, VPT, Syfer, Eurofarad, Texas Instruments, MS Kennedy, Miteq, Cobham, E2V, MA-COM, Hittite, Mini-Circuits, General Dynamics и др.);

Компания «Океан Электроники» является официальным дистрибьютором и эксклюзивным представителем в России одного из крупнейших производителей разъемов военного и аэрокосмического назначения «JONHON», а так же официальным дистрибьютором и эксклюзивным представителем в России производителя высокотехнологичных и надежных решений для передачи СВЧ сигналов «FORSTAR».



## JONHON

«JONHON» (основан в 1970 г.)

Разъемы специального, военного и аэрокосмического назначения:

(Применяются в военной, авиационной, аэрокосмической, морской, железнодорожной, горно- и нефтедобывающей отраслях промышленности)

«FORSTAR» (основан в 1998 г.)

ВЧ соединители, коаксиальные кабели, кабельные сборки и микроволновые компоненты:

(Применяются в телекоммуникациях гражданского и специального назначения, в средствах связи, РЛС, а так же военной, авиационной и аэрокосмической отраслях промышленности).



Телефон: 8 (812) 309-75-97 (многоканальный)

Факс: 8 (812) 320-03-32

Электронная почта: [ocean@oceanchips.ru](mailto:ocean@oceanchips.ru)

Web: <http://oceanchips.ru/>

Адрес: 198099, г. Санкт-Петербург, ул. Калинина, д. 2, корп. 4, лит. А