



### Typical Applications

The HMC338LC3B is ideal for:

- Point-to-Point Radios
- Point-to-Multi-Point Radios & VSAT
- Test Equipment & Sensors
- Military End-Use
- SAT COM

### Features

- Integrated LO Amplifier: -5 dBm Input
- Sub-Harmonically Pumped (x2) LO
- DC - 3 GHz Wideband IF
- RoHS Compliant 3x3 mm SMT Package
- Single Positive Supply: +4V @ 31mA

### Functional Diagram

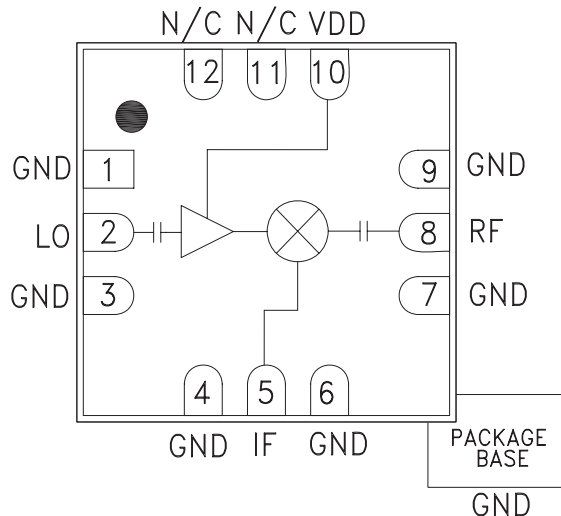

### General Description

The HMC338LC3B is a 24 - 34 GHz Sub-harmonically Pumped (x2) MMIC Mixer with an integrated LO amplifier in a leadless RoHS compliant SMT package. The 2LO to RF isolation is excellent at 30 dB, eliminating the need for additional filtering. The LO amplifier is a single bias (+3V to +4V) design with a nominal -5 dBm drive requirement. The RF and LO ports are DC blocked and matched to 50 Ohms for ease of use while the IF covers DC to 3 GHz. The HMC338LC3B eliminates the need for wire bonding, allowing use of surface mount manufacturing techniques.

### Electrical Specifications, $T_A = +25^\circ C$ , As a Function of Vdd

Parameter	IF = 1 GHz LO = -5 dBm & Vdd = +4V			IF = 1 GHz LO = -5 dBm & Vdd = +4V			IF = 1 GHz LO = -5 dBm & Vdd = +3V			Units
	Min.	Typ.	Max.	Min.	Typ.	Max.	Min.	Typ.	Max.	
Frequency Range, RF	24 - 27			25 - 31			31 - 34			GHz
Frequency Range, LO	11.5 - 13			12 - 15			15 - 16.5			GHz
Frequency Range, IF	DC - 3			DC - 3			DC - 3			GHz
Conversion Loss		11	15		11	15		15	18	dB
2LO to RF Isolation	25	30		25	33		30	40		dB
2LO to IF Isolation	37	45		37	50		40	50		dB
IP3 (Input)		9			13			14.5		dBm
1 dB Compression (Input)		3			5			6.5		dBm
Supply Current (Idd)		31	40		31	40		29	40	mA

\*Unless otherwise noted, all measurements performed as downconverter, IF= 1 GHz.



## GaAs MMIC SUB-HARMONIC SMT MIXER, 24 - 34 GHz

**Conversion Gain vs. Temperature @ LO = -4 dBm, Vdd= +4V**

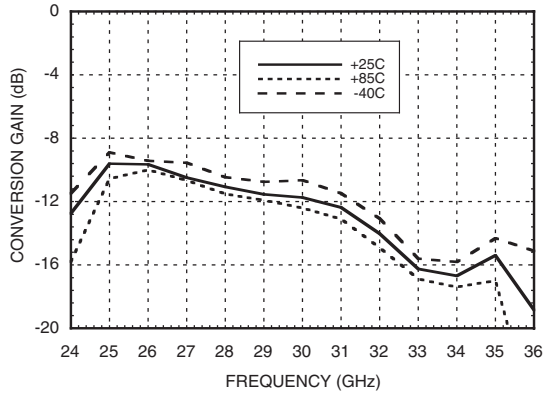

**Conversion Gain vs. Temperature @ LO = -4 dBm, Vdd= +3V**

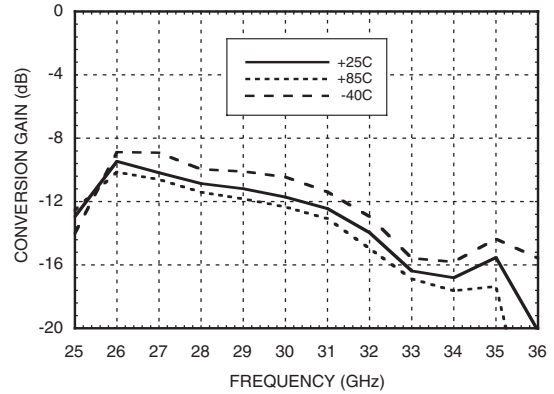

**Conversion Gain vs. LO Drive @ Vdd = +4V**

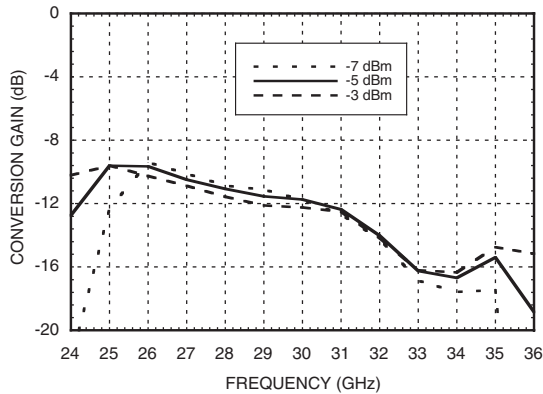

**Conversion Gain vs. LO Drive @ Vdd = +3V**

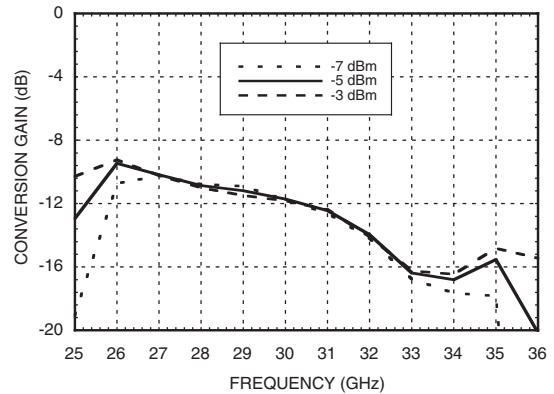

**Isolation @ Vdd = +4V**

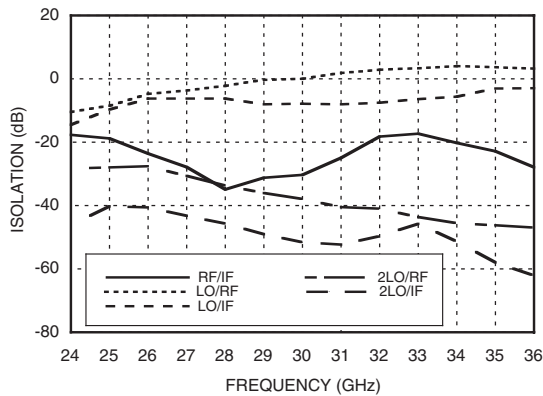

**Isolation @ Vdd = +3V**

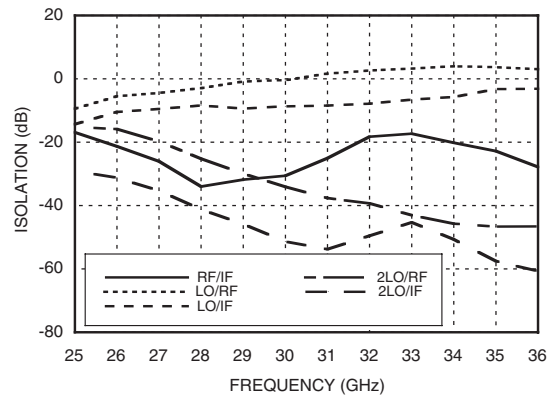



### GaAs MMIC SUB-HARMONIC SMT MIXER, 24 - 34 GHz

**Input IP3 vs. LO Drive @ Vdd = +4V \***

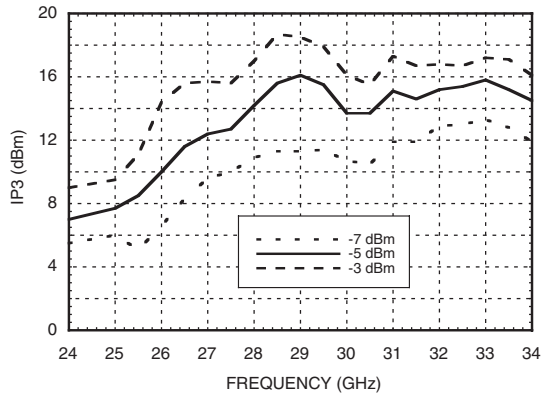

**Input IP3 vs. LO Drive @ Vdd = +3V \***

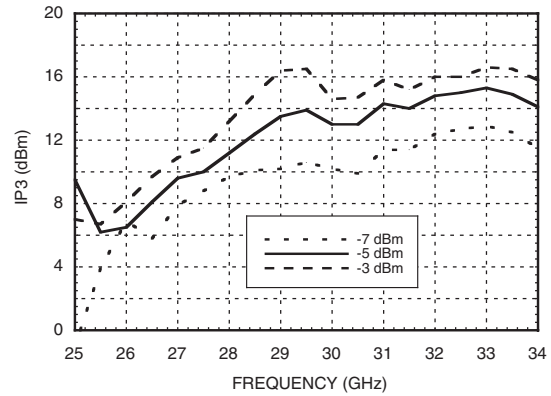

**Input IP2 vs. LO Drive @ Vdd = +4V \***

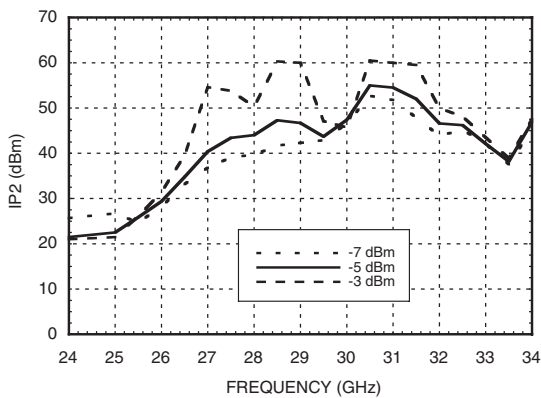

**Input IP2 vs. LO Drive @ Vdd = +3V \***

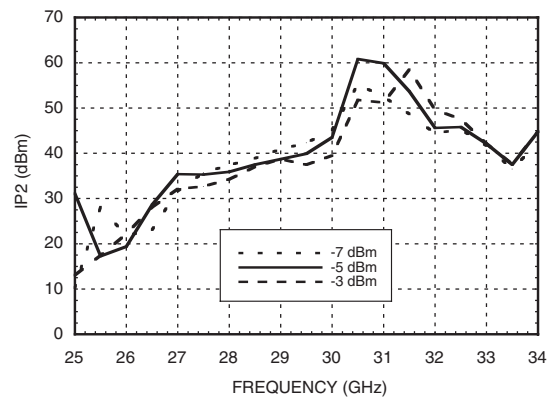

**Input P1dB vs. Temperature @ LO = -4 dBm, Vdd = +4V**

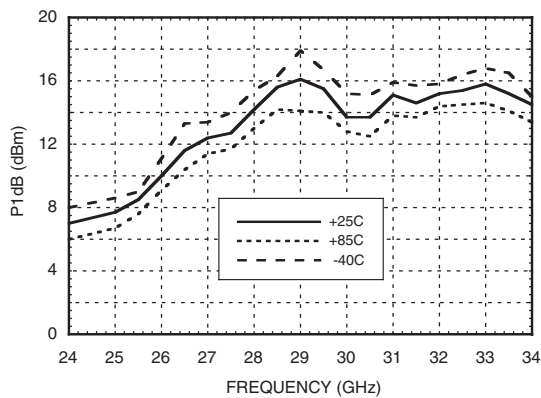

**Input P1dB vs. Temperature @ LO = -4 dBm, Vdd = +3V**

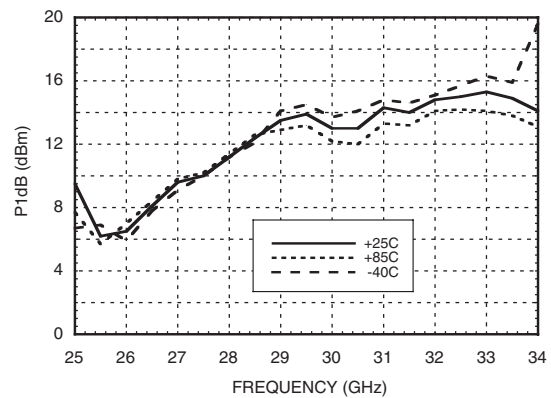

\* Two-tone input power = -10 dBm each tone, 1 MHz spacing.

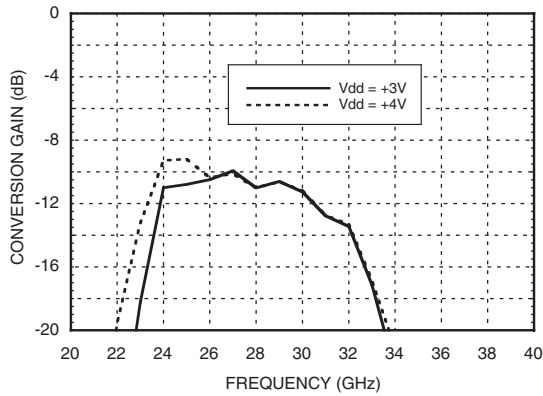
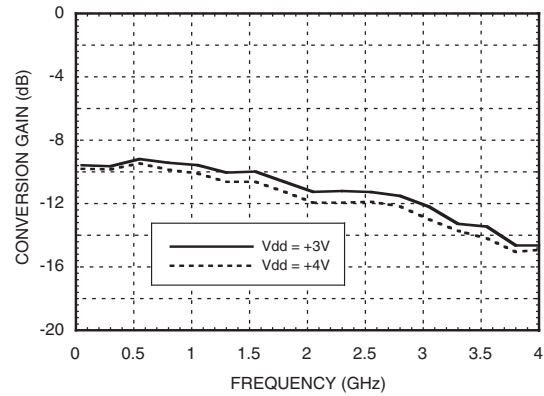
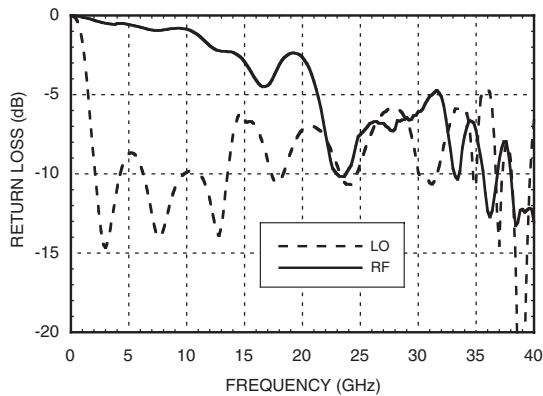
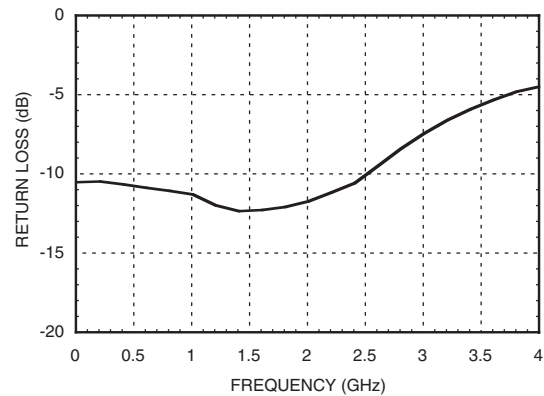
**Upconverter Performance  
Conversion Gain @ LO = -4 dBm**

**IF Bandwidth @ LO = -4 dBm**

**RF & LO Return Loss @ LO = -4 dBm**

**IF Return Loss @ LO = -4 dBm**



## GaAs MMIC SUB-HARMONIC SMT MIXER, 24 - 34 GHz

### MxN Spurious Outputs @ IF Port, Vdd = 4V

mRF	nLO					
	±5	±4	±3	±2	±1	0
-3						
-2	62					
-1	75	42	67			
0			12	34	-8	
1				0	55	13
2		65	51		68	
3	95					

RF = 31 GHz @ -10 dBm  
LO = 15 GHz @ -5 dBm  
All values in dBc below IF power level (1RF - 2LO)  
Measured as downconverter

### MxN Spurious Outputs @ RF Port, Vdd = 4V

mIF	nLO					
	±5	±4	±3	±2	±1	0
-3				42		
-2			25	60	40	
-1			45	0	41	
0			-3	23	-17	
1			49	0	38	13
2			32	63	30	67
3				46		57

IF = 1 GHz @ -10 dBm  
LO = 15 GHz @ -5 dBm  
All values in dBc below IF power level (1IF - 2LO)  
Measured as upconverter

### Absolute Maximum Ratings

RF / IF Input (Vdd = +5V)	+10 dBm
LO Drive (Vdd = +5V)	+13 dBm
Vdd	5.5V
Channel Temperature	175 °C
Continuous P <sub>diss</sub> (Ta = 85 °C) (derate 2.52 mW/°C above 85 °C)	227 mW
Thermal Resistance (junction to ground paddle)	397 °C/W
Storage Temperature	-65 to +150 °C
Operating Temperature	-40 to +85 °C



**ELECTROSTATIC SENSITIVE DEVICE  
OBSERVE HANDLING PRECAUTIONS**

**Outline Drawing**

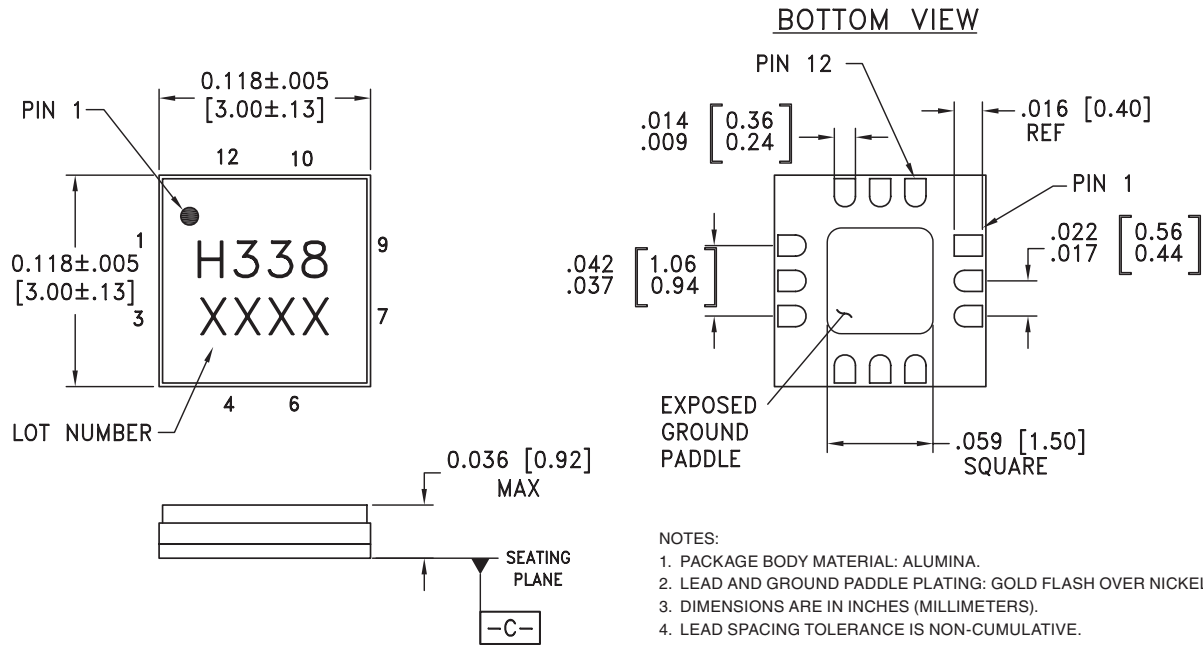

- NOTES:
1. PACKAGE BODY MATERIAL: ALUMINA.
  2. LEAD AND GROUND PADDLE PLATING: GOLD FLASH OVER NICKEL.
  3. DIMENSIONS ARE IN INCHES (MILLIMETERS).
  4. LEAD SPACING TOLERANCE IS NON-CUMULATIVE.
  5. CHARACTERS TO BE HELVETICA MEDIUM, .025 HIGH, BLACK INK, OR LASER MARK LOCATED APPROX. AS SHOWN.
  6. PACKAGE WARP SHALL NOT EXCEED 0.05MM DATUM 
  7. ALL GROUND LEADS AND GROUND PADDLE MUST BE SOLDERED TO PCB RF GROUND.

**Pin Descriptions**

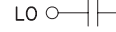
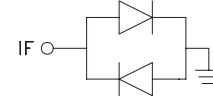
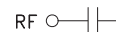
Pin Number	Function	Description	Interface Schematic
1, 3, 4, 6, 7, 9	GND	Package bottom must also be connected to RF/DC ground.	
2	LO	This pin is AC coupled and matched to 50 Ohms from 12 - 17 GHz.	
5	IF	This pin is DC coupled and should be DC blocked externally using a series capacitor whose value has been chosen to pass the necessary IF frequency range. Any applied DC voltage to this pin will result in die non-function and possible die failure.	
8	RF	This pin is AC coupled and matched to 50 Ohms from 24 - 34 GHz.	
10	Vdd	Power supply for the LO Amplifier.	
11, 12	N/C	No connection required. These pins may be connected to RF/DC ground without affecting performance.	



**Application Circuit**

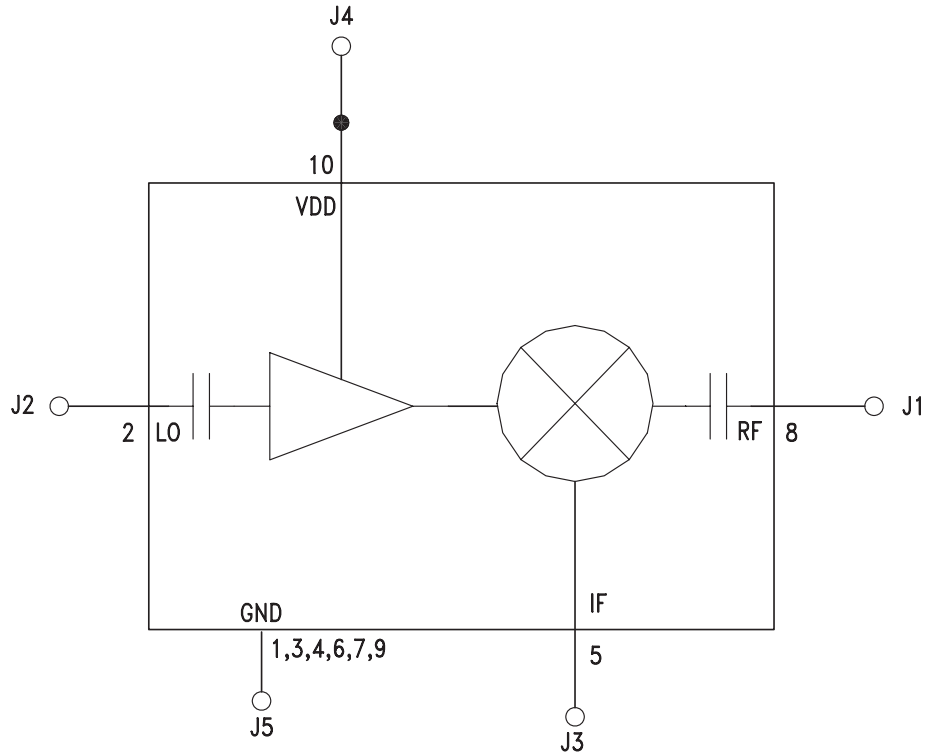

### Evaluation PCB

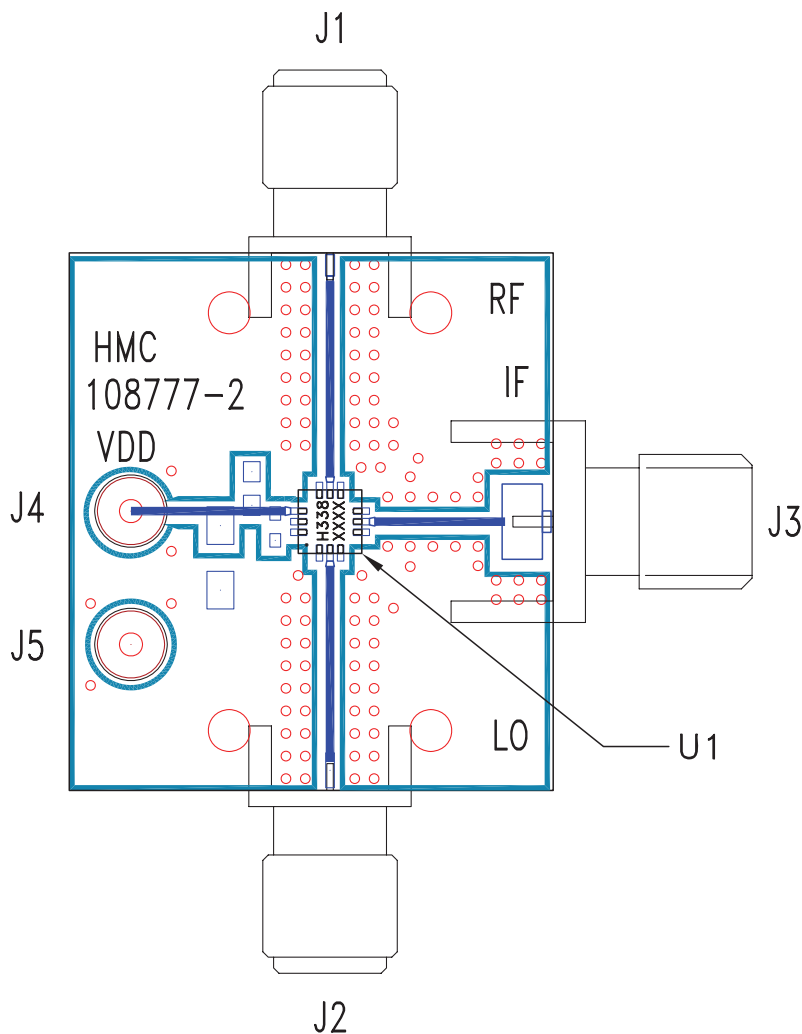

### List of Materials for Evaluation PCB 108779 [1]

Item	Description
J1 - J3	PCB Mount SMA Connector
J4, J5	DC Pin
U1	HMC338LC3B Mixer
PCB [2]	108777 Evaluation PCB

[1] Reference this number when ordering complete evaluation PCB

[2] Circuit Board Material: Rogers 4350

The circuit board used in this application should use RF circuit design techniques. Signal lines should have 50 ohm impedance while the package ground leads and exposed paddle should be connected directly to the ground plane similar to that shown. A sufficient number of via holes should be used to connect the top and bottom ground planes. The evaluation board should be mounted to an appropriate heat sink. The evaluation circuit board shown is available from Hittite upon request.



Компания «Океан Электроники» предлагает заключение долгосрочных отношений при поставках импортных электронных компонентов на взаимовыгодных условиях!

Наши преимущества:

- Поставка оригинальных импортных электронных компонентов напрямую с производств Америки, Европы и Азии, а так же с крупнейших складов мира;
- Широкая линейка поставок активных и пассивных импортных электронных компонентов (более 30 млн. наименований);
- Поставка сложных, дефицитных, либо снятых с производства позиций;
- Оперативные сроки поставки под заказ (от 5 рабочих дней);
- Экспресс доставка в любую точку России;
- Помощь Конструкторского Отдела и консультации квалифицированных инженеров;
- Техническая поддержка проекта, помощь в подборе аналогов, поставка прототипов;
- Поставка электронных компонентов под контролем ВП;
- Система менеджмента качества сертифицирована по Международному стандарту ISO 9001;
- При необходимости вся продукция военного и аэрокосмического назначения проходит испытания и сертификацию в лаборатории (по согласованию с заказчиком);
- Поставка специализированных компонентов военного и аэрокосмического уровня качества (Xilinx, Altera, Analog Devices, Intersil, Interpoint, Microsemi, Actel, Aeroflex, Peregrine, VPT, Syfer, Eurofarad, Texas Instruments, MS Kennedy, Miteq, Cobham, E2V, MA-COM, Hittite, Mini-Circuits, General Dynamics и др.);

Компания «Океан Электроники» является официальным дистрибьютором и эксклюзивным представителем в России одного из крупнейших производителей разъемов военного и аэрокосмического назначения «JONHON», а так же официальным дистрибьютором и эксклюзивным представителем в России производителя высокотехнологичных и надежных решений для передачи СВЧ сигналов «FORSTAR».



## JONHON

«JONHON» (основан в 1970 г.)

Разъемы специального, военного и аэрокосмического назначения:

(Применяются в военной, авиационной, аэрокосмической, морской, железнодорожной, горно- и нефтедобывающей отраслях промышленности)

«FORSTAR» (основан в 1998 г.)

ВЧ соединители, коаксиальные кабели,  
кабельные сборки и микроволновые компоненты:

(Применяются в телекоммуникациях гражданского и специального назначения, в средствах связи, РЛС, а так же военной, авиационной и аэрокосмической отраслях промышленности).



Телефон: 8 (812) 309-75-97 (многоканальный)

Факс: 8 (812) 320-03-32

Электронная почта: [ocean@oceanchips.ru](mailto:ocean@oceanchips.ru)

Web: <http://oceanchips.ru/>

Адрес: 198099, г. Санкт-Петербург, ул. Калинина, д. 2, корп. 4, лит. А