



## DP Series

- DC Reversing Solid State Contactor
- Ratings of 20, 40 & 60 Amps
- Load voltage ratings of 1-48 VDC
- Optional Soft Start w/Brake, Soft Start/Soft Stop no Brake
- LED input status indicator. Green (Forward), Yellow (Reverse)
- DC control
- cULus Recognized, IEC Rated, CE & RoHS Compliant

### PRODUCT SELECTION

| Control Voltage | 20 A      | 40 A      | 60 A      |
|-----------------|-----------|-----------|-----------|
| 4-15 VDC        | DP4R60D20 | DP4R60D40 | DP4R60D60 |
| 18-32 VDC       | DP4R60E20 | DP4R60E40 | DP4R60E60 |

### AVAILABLE OPTIONS

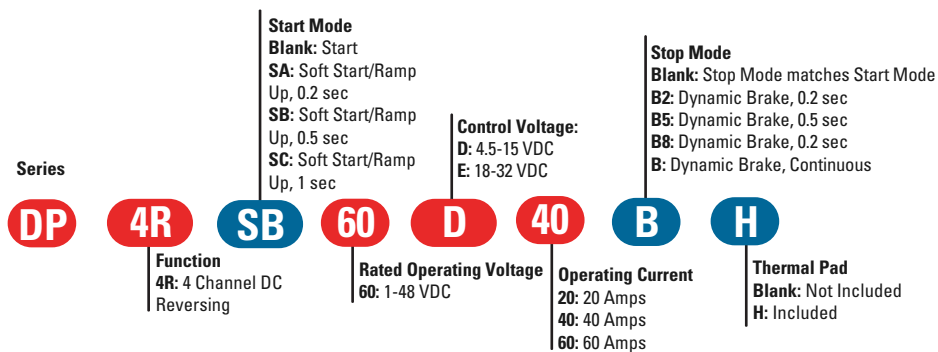

- Required for valid part number
- For options only and not required for valid part number

### OUTPUT SPECIFICATIONS <sup>(1)</sup>

| Description  | 20 A             | 40 A            | 60 A            |
|--|------------------|-----------------|-----------------|
| Operating Voltage [VDC]  | 1-48             | 1-48            | 1-48            |
| UL 508 Resistive Load, IEC 60947-4-1 DC-1 [Adc]                              | 20               | 40              | 60              |
| UL 508 Motor Controller, IEC 60947-4-1 DC-3 [FLA]                            | 13               | 14              | 15              |
| Minimum Load Current [A]   | 0.10             | 0.10            | 0.10            |
| Maximum Surge Current (10ms) [Adc]   | 80               | 140             | 240             |
| Maximum Off-State Leakage Current @ Rated Voltage [µA]                       | 20               | 20              | 20              |
| Maximum On-State Voltage Drop @ Rated Current [Vdc]                          | 0.28             | 0.28            | 0.30            |
| Combined Thermal Resistance Junction to Case [Rjc] [°C/W]                    | 0.40             | 0.20            | 0.13            |
| Maximum On-State Resistance, per switch, (RDS-ON) [Ohms]                     | 0.014            | 0.007           | 0.005           |
| Total Power Dissipation per module, 2 switches conducting, Tj=100° C [Watts] | 20               | 40              | 60              |
| Internal PWM For Soft Start/Stop Versions [Duty Cycle 10-100%] [Hz]          | 200              | 200             | 200             |
| Output Terminal Screw size   | 10-32 Combo Head | 1/4-20 Hex      | 1/4-20 Hex      |
| Screw Torque Range [in lbs/Nm]   | 15-20 / 1.7-2.3  | 20-25 / 2.3-2.8 | 20-25 / 2.3-2.8 |
| Maximum Wire Size  | 10 AWG           | 8 AWG           | 6 AWG           |
| Weight (typical)   | 10.9 oz (310g)   | 12.2 oz (345g)  | 12.2 oz (345g)  |

**INPUT SPECIFICATIONS (1)**

| Description                                      | DR4R60Dxx                    | DR4R60Exx                    |
|--|------------------------------|------------------------------|
| Logic Supply Voltage Range [VDC]                 | 4.5-15                       | 18-32                        |
| Minimum Logic Supply Current [mA] (2)            | 16                           | 20                           |
| Maximum Logic Supply Current [mA] (2)            | 20                           | 25                           |
| Control Voltage Range [VDC]                      | 4.5-15                       | 18-32                        |
| Minimum Control Input Current @ Min voltage [mA] | 0.20                         | 1.0                          |
| Maximum Control Input Current @ Max voltage [mA] | 1.0                          | 2.0                          |
| Typical Interlocking Time [msec]                 | 200                          | 200                          |
| Mating Connector (Not Supplied)                  | Molex 50579404 or Equivalent | Molex 50579404 or Equivalent |

**GENERAL SPECIFICATIONS**

| Description                                      | Parameters                     |
|--|--------------------------------|
| Dielectric Strength, Input/Output/Base (50/60Hz) | 2500 Vrms                      |
| Minimum Insulation Resistance (@ 500 VDC)        | 10 <sup>9</sup> Ohm            |
| Maximum Capacitance, Input to Output (pF)        | 10 pF                          |
| Ambient Operating Temperature Range              | -30 to 80°C                    |
| Ambient Storage Temperature Range                | -40 to 125 °C                  |
| Housing Material                                 | Valox 420 SEO Black, UL 94 V-0 |
| Encapsulation                                    | Thermally conductive Epoxy     |

**GENERAL NOTES**

- (1) All parameters at 25°C unless otherwise specified.
- (2) Input circuit incorporates active current limiter.

**WIRING DIAGRAM**

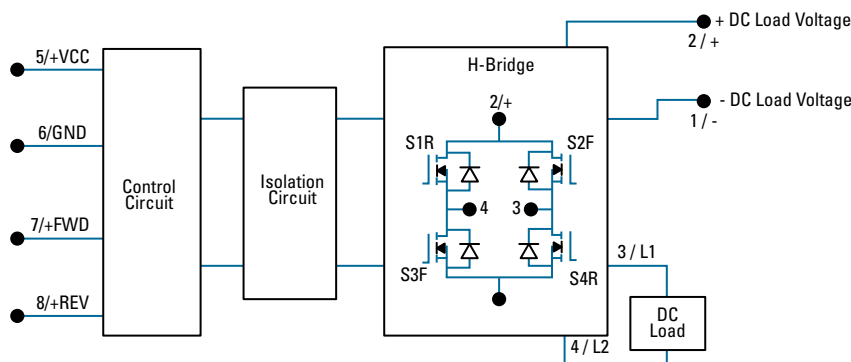

| Status Functions         | Green LED (Forward)     | Yellow LED (Reverse)    |
|--------------------------|-------------------------|-------------------------|
| Initial Logic Voltage On | Flash Twice             | Flash Twice             |
| Forward ON               | ON                      | OFF                     |
| Reverse ON               | OFF                     | ON                      |
| Dynamic Brake            | Flash Once              | Flash Once              |
| Interlocking             | Flash 3x Intermittently | Flash 3x Intermittently |

**MECHANICAL SPECIFICATIONS**

Tolerances: ±0.02 in / 0.5 mm  
 All dimensions are in: inches [millimeters]

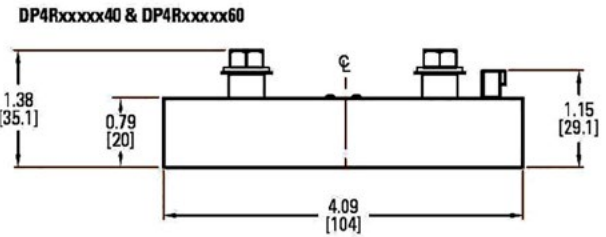
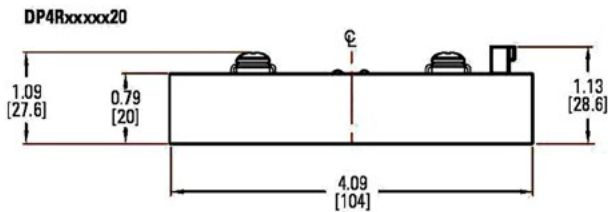
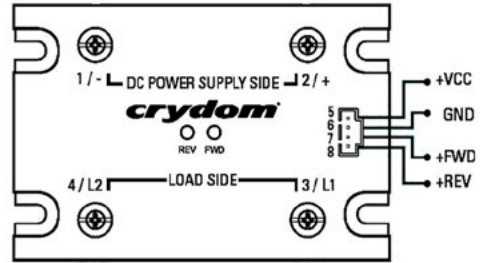
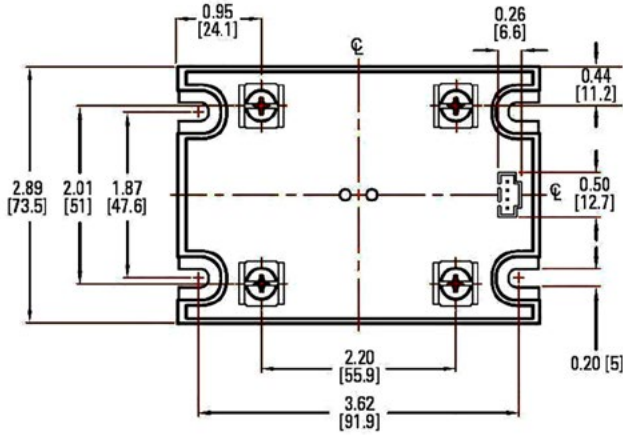

**THERMAL DERATE INFORMATION**

DP Series Derating Curve

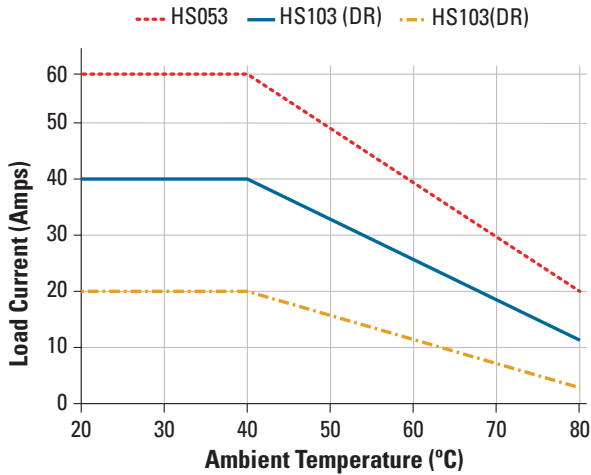

**AGENCY APPROVALS**

**Agency Approvals**

IEC 60068-2-6 Vibration – Compliant [1.55mm/ 10-55Hz]  
 IEC 60068-2-27 Shock – Compliant [15G/11ms]  
 IEC 61000-4-2: Electrostatic Discharge – Level 2  
 IEC 61000-4-4: Electrically Fast Transients – Level 2 (Criteria A)  
 IEC 61000-4-5: Electrical Surges - Level 2 (Criteria A)



Rev. 092217  
 ECN 20325

**ACCESSORIES**

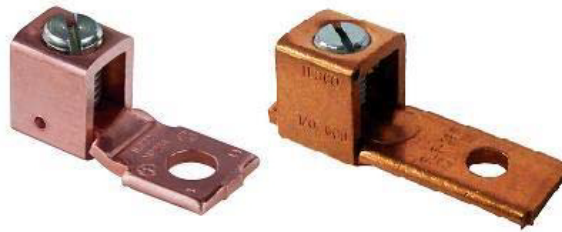

**TYPICAL PROPERTIES**

| Description                         | TRM6                      | TRM1                      |
|-------------------------------------|---------------------------|---------------------------|
| Screw Mount Size                    | #8, #10, M4, M5 or 1/4-20 | #8, #10, M4, M5 or 1/4-20 |
| Mounting screw torque [in lbs/nm]   | 20/2.3                    | 20/2.3                    |
| Wire Size [AWG]                     | 14-6                      | 6-0                       |
| Wire clamp screw torque [in lbs/nm] | 10-15/1.3-1.7             | 10-15/1.3-1.7             |
| Wire clamp screw thread             | 1/4-28                    | 1/4-28                    |
| Lug Material                        | Cooper                    | Cooper                    |

**OPERATING MODES**

**Operating Modes**

**Start:** When either FWD or REV Control signal is applied, and after Control Signal Delay, DC power supply on terminals 1/- and 2/+ is directly connected to Load at terminals 3/L1 and 4/L2 with a polarity according to the control signal. The start option can be combined with Stop and/or Dynamic Brake options.

**Stop:** Load is disconnected from DC power supply. All FET switches (S1, S2, S3 & S4) inside the DP Series SSC are turned off. This simple Stop option is available only in combination with the simple Start option (suffix Blank).

**Soft Start/Ramp Up:** It is a modified Start where the DC power supply is connected to the load using a 200 Hz pulse width modulation with a duty cycle going from 10% to 100%. Soft Start/Ramp Up time is defined to SA, SB and SC suffixes. After Soft Start/Ramp Up time is elapsed, the Load will remain continuously energized for as long as FWD or REV Control signal is applied. This option can be combined with Soft Stop/Ramp Down, and Dynamic Braking modes, but not with simple Stop.

**Soft Start/Ramp Down:** It is a modified Stop where the DC power supply

is disconnected from Load using a 200 Hz pulse width modulation with a duty cycle going from 100% to 0%. After Soft Stop/Ramp Down time is elapsed, the Load will remain continuously de-energized waiting for a new FWD or REV Control signal. Soft Stop/Ramp time is tied to Soft Start/Ramp Up time selected by SA, SB and SC suffixes and can be combined with Soft Start/Ramp Up only.

**Dynamic Brake:** It could be used as modified Stop where the FET switches inside the DP Series SSC are arranged in such a way that they provide a path for the Load Current to keep flowing after the DC power supply has been disconnected. This mode allows for energy stored in some type of loads to be discharged. i.e. back EMF on DC motors. Timing for Dynamic Brake is selected by suffixes B2, B5, B8 and B where the latest will keep the braking or discharging path enabled for as long as FWD and REV Control signals are removed.

**Interlock:** It will shut down all FET switches inside the DP Series within 0.2 sec after both control signals FWD and REV are applied at the same time. An Interlock condition will trigger a modified Stop such as Soft Stop/Ramp Down or Dynamic Brake whenever an option has been selected.

**Control Signals**

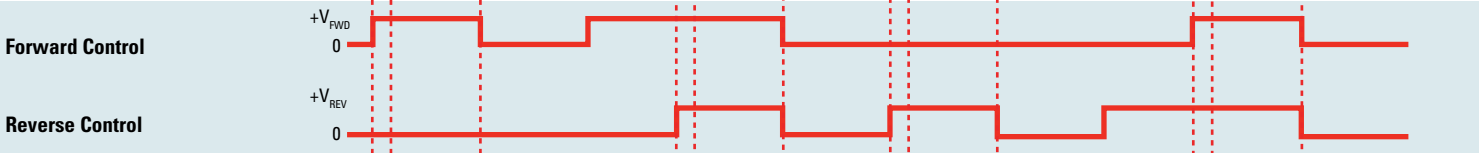

**Load Voltage Signals (H)**

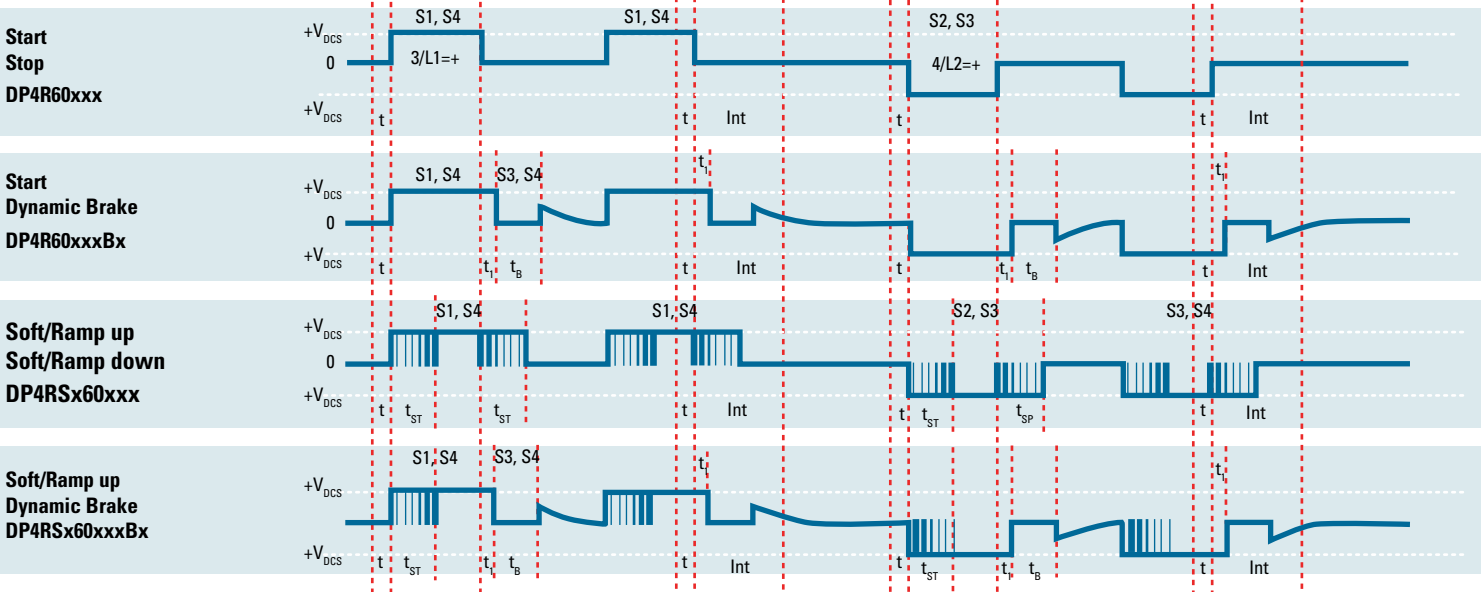

Int: Interlock  
 t: Control Signal Validation Delay = 0.2 sec, except for Start / Stop (0.025 sec)  
 t<sub>i</sub>: 0.15 sec Break-before-make delay  
 t<sub>b</sub>: Dynamic Brake time  
 B2: 0.2 sec  
 B5: 0.5 sec  
 B8: 0.8 sec  
 B: Continuous

t<sub>sp</sub>: Soft Stop/Ramp Down time = t<sub>st</sub>  
 t<sub>st</sub>: Soft Start/Ramp Up time  
 SA: 0.2 sec  
 SB: 0.5 sec  
 SC: 1 sec  
 V<sub>DCS</sub>: VDC power supply  
 t<sub>FWD</sub>: Forward Control Signal  
 t<sub>REV</sub>: Reverse Control Signal

(H) Load voltage signals shown are typical of a DC motor, behavior may change for other load types.

| <b>DANGER / PELIGRO / DANGER /GEFAHR / PERICOLO / 危險</b>   |  |   |  |  |   |
|--|--|---|--|--|---|
| <p><b>HAZARD OF ELECTRIC SHOCK, EXPLOSION, OR ARC FLASH.</b></p> <ul style="list-style-type: none"> <li>• Disconnect all power before installing or working with this equipment.</li> <li>• Verify all connections and replace all covers before turning on power.</li> </ul> <p><b>Failure to follow these instructions will result in death or serious injury.</b></p> | <p><b>RIESGO DE DESCARGA ELECTRICA O EXPLOSION.</b></p> <ul style="list-style-type: none"> <li>• Desconectar todos los suministros de energia a este equipo antes de trabajar con este equipo.</li> <li>• Verificar todas las conexiones y colocar todas las tapas antes de energizar el equipo.</li> </ul> <p><b>El incumplimiento de estas instrucciones puede provocar la muerte o lesiones serias.</b></p> | <p><b>RISQUE DE DESCARGE ELECTRIQUE OU EXPLOSION</b></p> <ul style="list-style-type: none"> <li>• Eteindre toutes les sources d'énergie de cet appareil avant de travailler dessus de cet appareil</li> <li>• Vérifier tous connections, et remettre tous couverts en olace avant de mettre sous</li> </ul> <p><b>De non-suivi de ces instructions provoquera la mort ou des lésions sérieuses.</b></p> | <p><b>GEFAHR EINES ELEKTRISCHE N SCHLAGES ODER EINER EXPLOSION.</b></p> <ul style="list-style-type: none"> <li>• Stellen Sie jeglichen Strom ab, der dieses Gerät versorgt, bevor Sie an dem Gerät Arbeiten durchführen</li> <li>• Vor dem Drehen auf Energie alle Anschlüsse überprüfen und alle Abdeckungen ersetzen.</li> </ul> <p><b>Unterlassung dieser Anweisungen können zum Tode oder zu schweren Verletzungen führen.</b></p> | <p><b>RISCHIO DI SCOSSA ELETTRICA O DELL'ESPLOSIONE.</b></p> <ul style="list-style-type: none"> <li>• Spenga tutta l'alimentazione che fornisce questa apparecchiatura prima di lavorare a questa apparecchiatura</li> <li>• Verificare tutti i collegamenti e sostituire tutte le coperture prima dell'accensione</li> </ul> <p><b>L'omissione di queste istruzioni provocherà la morte o lesioni serie</b></p> | <p><b>存在电击、爆炸或电弧闪烁危险</b></p> <ul style="list-style-type: none"> <li>• 在操作此设备之前请先关闭电源。</li> </ul> <p><b>若不遵守这些说明,可能会导致严重的人身伤害甚至死亡。</b></p> |

| <b>WARNING / AVERTISSEMENT / WARNUNG /ADVERTENCIA / AVVERTENZA / 警告</b>   |  |  |
|---|--|--|
| <p><b>RISK OF MATERIAL DAMAGE AND HOT ENCLOSURE</b></p> <ul style="list-style-type: none"> <li>• The product's side panels may be hot, allow the product to cool before touching.</li> <li>• Follow proper mounting instructions including torque values.</li> <li>• Do not allow liquids or foreign objects to enter this product.</li> </ul> <p><b>Failure to follow these instructions can result in serious injury, or equipment damage.</b></p>  | <p><b>RISQUE DE DOMMAGE MATERIEL ET DE SURCHAUFFE DU BOITIER</b></p> <ul style="list-style-type: none"> <li>• Les panneaux latéraux du produit peuvent être chauds. Laisser le produit refroidir avant de le toucher.</li> <li>• Respecter les consignes de montage, et notamment les couples de serrage.</li> <li>• Ne pas laisser pénétrer de liquide ni de corps étrangers à l'intérieur du produit.</li> </ul> <p><b>Le non-respect de cette directive peut entraîner, des lésions corporelles graves ou des dommages matériels.</b></p> | <p><b>GEFAHR VON MATERIALSCHÄDEN UND GEHÄUSEERHITZUNG</b></p> <ul style="list-style-type: none"> <li>• Die Seitenwände können heiß sein. Lassen Sie das Produkt abkühlen, bevor Sie es berühren.</li> <li>• Beachten Sie die Montageanweisungen,</li> <li>• Führen Sie keine Flüssigkeiten oder Fremdkörper in das Produkt ein.</li> </ul> <p><b>Die Nichtbeachtung dieser Anweisung kann Körperverletzung oder Materialschäden zur Folge haben.</b></p> |
| <p><b>RIESGO DE DAÑOS MATERIALES Y DE SOBRECIENTAMIENTO DE LA UNIDAD</b></p> <ul style="list-style-type: none"> <li>• Los paneles laterales del producto pueden estar calientes. Esperar que el producto se enfríe antes de tocarlo.</li> <li>• Respetar las instrucciones de montaje, y en particular los pares de apretado.</li> <li>• No dejar que penetren líquidos o cuerpos extraños en el producto.</li> </ul> <p><b>Si no se respetan estas precauciones pueden producirse graves lesiones, daños materiales.</b></p> | <p><b>RISCHIO DI DANNI MATERIALI E D'INVOLUCRO CALDO</b></p> <ul style="list-style-type: none"> <li>• I pannelli laterali dell'apparecchio possono scottare; lasciar quindi raffreddare il prodotto prima di toccarlo.</li> <li>• Seguire le istruzioni di montaggio corrette.</li> <li>• Non far entrare liquidi o oggetti estranei in questo apparecchio.</li> </ul> <p><b>La mancata osservanza di questa precauzione può causare gravi rischi per l'incolumità personale o danni alle apparecchiature.</b></p>                           | <p><b>材料损坏和高温外壳的危险性</b></p> <ul style="list-style-type: none"> <li>• 产品的一侧面板可能很热, 在其冷却前请不要触碰。</li> <li>• 遵照正确的安装说明, 包括扭矩值。</li> <li>• 请勿让液体及其他异物进入本产品。</li> </ul> <p><b>如不能正确执行这些操作说明, 极有可能造成严重人体伤害或者设备的损坏。</b></p>  |

**ANNEX - ENVIRONMENTAL INFORMATION**

The environmental information disclosed in this annex including the EIP Pollution logo are in compliance with People’s Republic of China Electronic Industry Standard SJ/T11364 – 2006, Marking for Control of Pollution Caused by Electronic Information Products.

| Part Name         | Toxic or hazardous Substance and Elements |              |              |                               |                                |                                       |
|-------------------|---|--------------|--------------|-------------------------------|--------------------------------|---------------------------------------|
|                   | Lead (Pb)                                 | Mercury (Hg) | Cadmium (Cd) | Hexavalent Chromium (Cr (VI)) | Polybrominated biphenyls (PBB) | Polybrominated diphenyl ethers (PBDE) |
| Semiconductor die | X   | O            | O            | O                             | O                              | O                                     |
| Solder            | X   | O            | O            | O                             | O                              | O                                     |

附件 – 环保信息

此附件所标示的包括电子信息产品污染图标的环保信息符合中华人民共和国电子行业标准 SJ/T11364 - 2006, 电子信息产品污染控制标识要求。

| 部件名称  | 有毒有害物质或元素 |        |        |               |            |              |
|-------|-----------|--------|--------|---------------|------------|--------------|
|       | 铅 (Pb)    | 汞 (Hg) | 镉 (Cd) | 六价铬 (Cr (VI)) | 多溴联苯 (PBB) | 多溴二苯醚 (PBDE) |
| 半导体芯片 | X         | O      | O      | O             | O          | O            |
| 焊接点   | X         | O      | O      | O             | O          | O            |



Компания «Океан Электроники» предлагает заключение долгосрочных отношений при поставках импортных электронных компонентов на взаимовыгодных условиях!

Наши преимущества:

- Поставка оригинальных импортных электронных компонентов напрямую с производств Америки, Европы и Азии, а так же с крупнейших складов мира;
- Широкая линейка поставок активных и пассивных импортных электронных компонентов (более 30 млн. наименований);
- Поставка сложных, дефицитных, либо снятых с производства позиций;
- Оперативные сроки поставки под заказ (от 5 рабочих дней);
- Экспресс доставка в любую точку России;
- Помощь Конструкторского Отдела и консультации квалифицированных инженеров;
- Техническая поддержка проекта, помощь в подборе аналогов, поставка прототипов;
- Поставка электронных компонентов под контролем ВП;
- Система менеджмента качества сертифицирована по Международному стандарту ISO 9001;
- При необходимости вся продукция военного и аэрокосмического назначения проходит испытания и сертификацию в лаборатории (по согласованию с заказчиком);
- Поставка специализированных компонентов военного и аэрокосмического уровня качества (Xilinx, Altera, Analog Devices, Intersil, Interpoint, Microsemi, Actel, Aeroflex, Peregrine, VPT, Syfer, Eurofarad, Texas Instruments, MS Kennedy, Miteq, Cobham, E2V, MA-COM, Hittite, Mini-Circuits, General Dynamics и др.);

Компания «Океан Электроники» является официальным дистрибьютором и эксклюзивным представителем в России одного из крупнейших производителей разъемов военного и аэрокосмического назначения «JONHON», а так же официальным дистрибьютором и эксклюзивным представителем в России производителя высокотехнологичных и надежных решений для передачи СВЧ сигналов «FORSTAR».



## JONHON

«JONHON» (основан в 1970 г.)

Разъемы специального, военного и аэрокосмического назначения:

(Применяются в военной, авиационной, аэрокосмической, морской, железнодорожной, горно- и нефтедобывающей отраслях промышленности)

«FORSTAR» (основан в 1998 г.)

ВЧ соединители, коаксиальные кабели, кабельные сборки и микроволновые компоненты:

(Применяются в телекоммуникациях гражданского и специального назначения, в средствах связи, РЛС, а так же военной, авиационной и аэрокосмической отраслях промышленности).



Телефон: 8 (812) 309-75-97 (многоканальный)

Факс: 8 (812) 320-03-32

Электронная почта: [ocean@oceanchips.ru](mailto:ocean@oceanchips.ru)

Web: <http://oceanchips.ru/>

Адрес: 198099, г. Санкт-Петербург, ул. Калинина, д. 2, корп. 4, лит. А