



Micro Commercial Components



Micro Commercial Components
 20736 Marilla Street Chatsworth
 CA 91311
 Phone: (818) 701-4933
 Fax: (818) 701-4939

US1AE THRU US1ME

1 Amp Ultra Fast Rectifier 50 to 1000 Volts

Features

- Halogen free available upon request by adding suffix "-HF"
- Ultra Fast Switching For High Efficiency
- For Surface Mounted Applications
- Low Forward Voltage Drop And High Current Capability
- Low Reverse Leakage Current
- Epoxy meets UL 94 V-0 flammability rating
- Moisture Sensitivity Level 1

Maximum Ratings

- Lead Free Finish/RoHS Compliant(NOTE 1) ("P" Suffix designates RoHS Compliant. See ordering information)
- Operating Temperature: -50°C to +150°C
- Storage Temperature: -50°C to +150°C
- Maximum Thermal Resistance; 30°C/W Junction To Lead

MCC Catalog Number	Device Marking	Maximum Recurrent Peak Reverse Voltage	Maximum RMS Voltage	Maximum DC Blocking Voltage
US1AE	US1A	50V	35V	50V
US1BE	US1B	100V	70V	100V
US1CE	US1C	150V	105V	150V
US1DE	US1D	200V	140V	200V
US1GE	US1G	400V	280V	400V
US1JE	US1J	600V	420V	600V
US1KE	US1K	800V	560V	800V
US1ME	US1M	1000V	700V	1000V

Electrical Characteristics @ 25°C Unless Otherwise Specified

Average Forward Current	$I_{F(AV)}$	1.0A	$T_L = 110^\circ\text{C}$
Peak Forward Surge Current	I_{FSM}	30A	8.3ms, half sine
Maximum Instantaneous Forward Voltage	V_F	1.0V 1.4V 1.7V	$I_{FM} = 1.0\text{A};$ $T_J = 25^\circ\text{C}$
Maximum DC Reverse Current At Rated DC Blocking Voltage	I_R	10 μA 100 μA	$T_A = 25^\circ\text{C}$ $T_A = 100^\circ\text{C}$
Maximum Reverse Recovery Time	T_{rr}	50ns 75ns	$I_F=0.5\text{A}, I_R=1.0\text{A},$ $I_{rr}=0.25\text{A}$
Typical Junction Capacitance	C_J	20pF 17pF	Measured at 1.0MHz, $V_R=4.0\text{V}$

Notes: 1. High Temperature Solder Exemption Applied, see EU Directive Annex Notes 7

(SMAE)

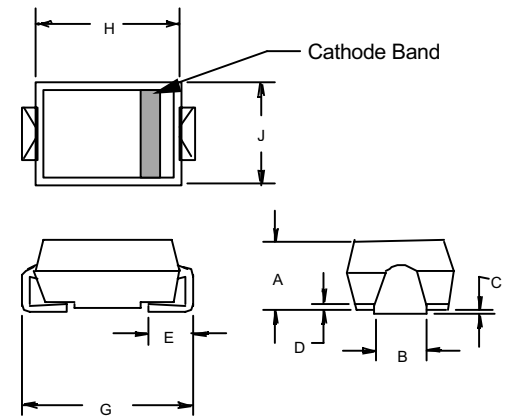

DIM	INCHES		MM		NOTE
	MIN	MAX	MIN	MAX	
A	.079	.096	2.01	2.44	
B	.045	.071	1.15	1.80	
C	.002	.008	.05	.20	
D	---	.02	---	.51	
E	.030	.060	.76	1.52	
G	.189	.208	4.80	5.30	
H	.157	.180	4.00	4.57	
J	.090	.115	2.29	2.92	

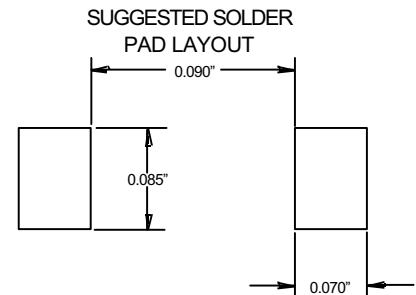

US1AE thru US1ME

Figure 1
Typical Forward Characteristics

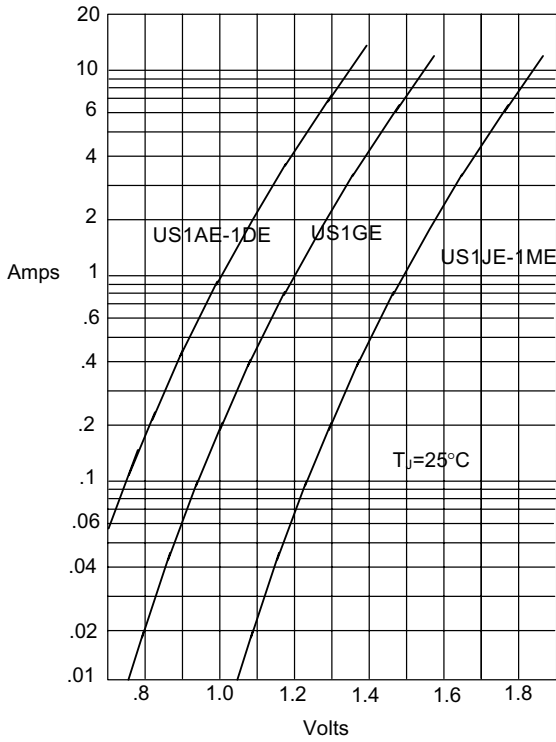

Instantaneous Forward Current - Amperes versus
Instantaneous Forward Voltage - Volts

Figure 2
Forward Derating Curve

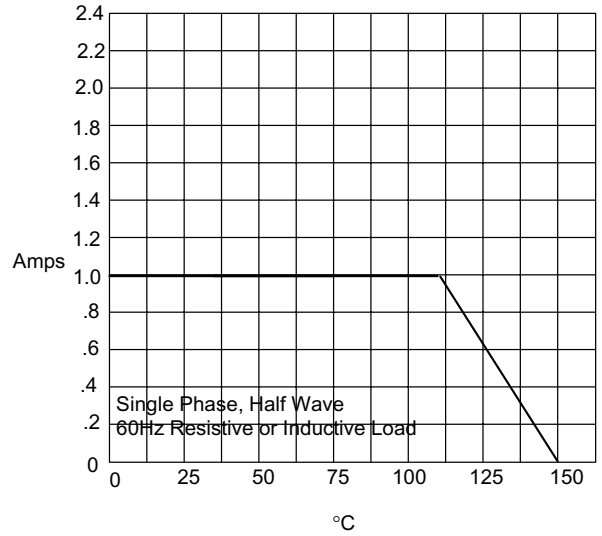

Average Forward Rectified Current - Amperes versus
Lead Temperature - $^\circ\text{C}$

Figure 3
Junction Capacitance

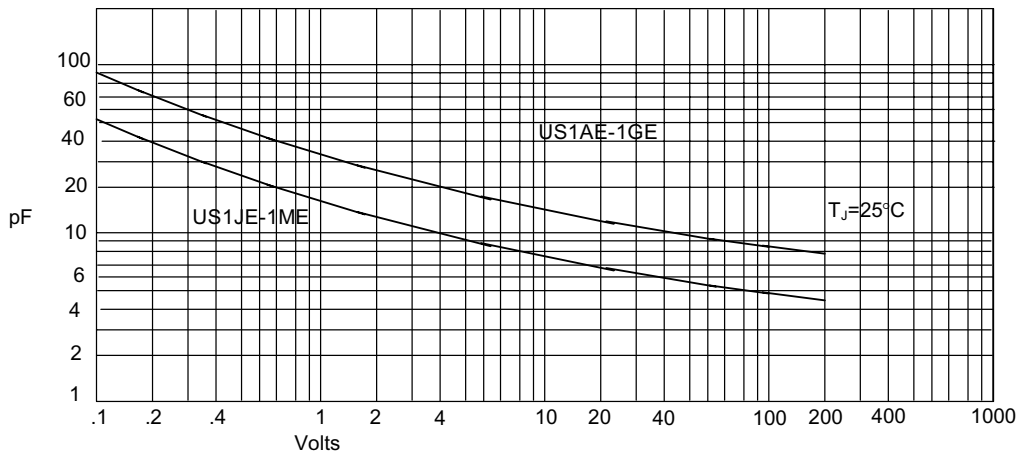

Junction Capacitance - pF versus
Reverse Voltage - Volts

US1AE thru US1ME

Figure 4
Peak Forward Surge Current

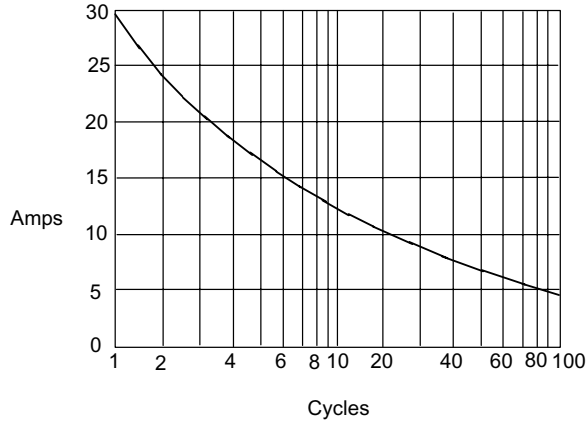

Peak Forward Surge Current - Amperes *versus* Number Of Cycles At 60Hz - Cycles

Figure 5
Peak Forward Surge Current

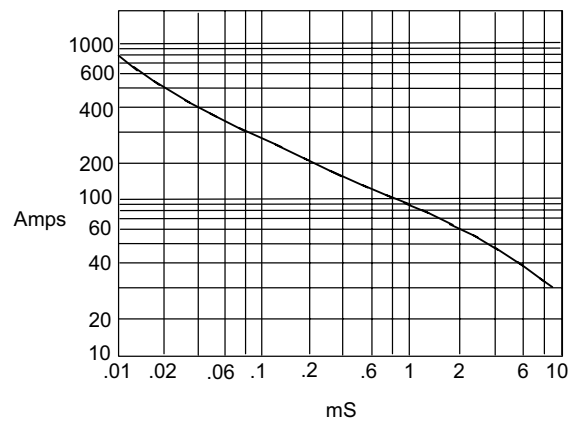

Peak Forward Surge Current - Amperes *versus* Pulse Duration - Milliseconds (mS)

Figure 6
Reverse Recovery Time Characteristic And Test Circuit Diagram

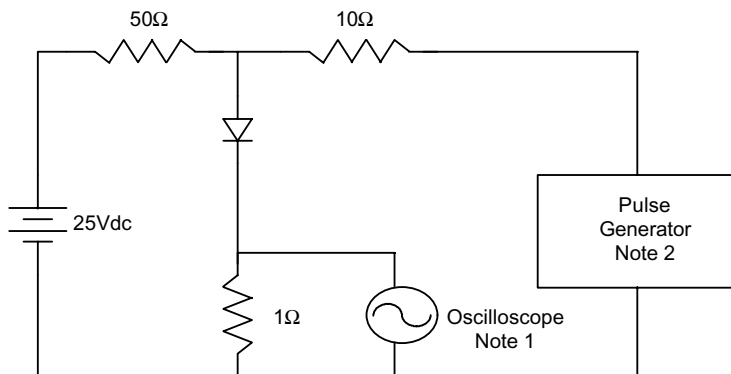

Notes:

1. Rise Time = 7ns max.
Input impedance = 1 megohm, 22pF
2. Rise Time = 10ns max.
Source impedance = 50 ohms
3. Resistors are non-inductive

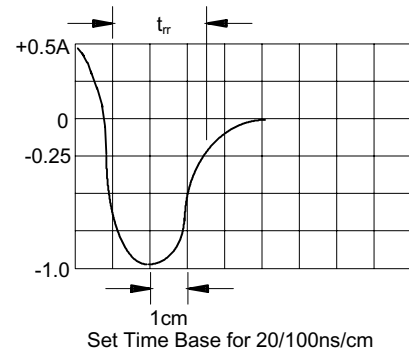



Ordering Information :

Device	Packing
Part Number-TP	Tape&Reel: 6Kpcs/Reel

Note : Adding "-HF" suffix for halogen free, eg. Part Number-TP-HF

IMPORTANT NOTICE
<p>Micro Commercial Components Corp. reserves the right to make changes without further notice to any product herein to make corrections, modifications , enhancements , improvements , or other changes . Micro Commercial Components Corp . does not assume any liability arising out of the application or use of any product described herein; neither does it convey any license under its patent rights ,nor the rights of others . The user of products in such applications shall assume all risks of such use and will agree to hold Micro Commercial Components Corp . and all the companies whose products are represented on our website, harmless against all damages.</p>
LIFE SUPPORT
<p>MCC's products are not authorized for use as critical components in life support devices or systems without the express written approval of Micro Commercial Components Corporation.</p>
CUSTOMER AWARENESS
<p>Counterfeiting of semiconductor parts is a growing problem in the industry. Micro Commercial Components (MCC) is taking strong measures to protect ourselves and our customers from the proliferation of counterfeit parts. MCC strongly encourages customers to purchase MCC parts either directly from MCC or from Authorized MCC Distributors who are listed by country on our web page cited below. Products customers buy either from MCC directly or from Authorized MCC Distributors are genuine parts, have full traceability, meet MCC's quality standards for handling and storage. MCC will not provide any warranty coverage or other assistance for parts bought from Unauthorized Sources. MCC is committed to combat this global problem and encourage our customers to do their part in stopping this practice by buying direct or from authorized distributors.</p>

Компания «Океан Электроники» предлагает заключение долгосрочных отношений при поставках импортных электронных компонентов на взаимовыгодных условиях!

Наши преимущества:

- Поставка оригинальных импортных электронных компонентов напрямую с производств Америки, Европы и Азии, а так же с крупнейших складов мира;
- Широкая линейка поставок активных и пассивных импортных электронных компонентов (более 30 млн. наименований);
- Поставка сложных, дефицитных, либо снятых с производства позиций;
- Оперативные сроки поставки под заказ (от 5 рабочих дней);
- Экспресс доставка в любую точку России;
- Помощь Конструкторского Отдела и консультации квалифицированных инженеров;
- Техническая поддержка проекта, помощь в подборе аналогов, поставка прототипов;
- Поставка электронных компонентов под контролем ВП;
- Система менеджмента качества сертифицирована по Международному стандарту ISO 9001;
- При необходимости вся продукция военного и аэрокосмического назначения проходит испытания и сертификацию в лаборатории (по согласованию с заказчиком);
- Поставка специализированных компонентов военного и аэрокосмического уровня качества (Xilinx, Altera, Analog Devices, Intersil, Interpoint, Microsemi, Actel, Aeroflex, Peregrine, VPT, Syfer, Eurofarad, Texas Instruments, MS Kennedy, Miteq, Cobham, E2V, MA-COM, Hittite, Mini-Circuits, General Dynamics и др.);

Компания «Океан Электроники» является официальным дистрибьютором и эксклюзивным представителем в России одного из крупнейших производителей разъемов военного и аэрокосмического назначения «JONHON», а так же официальным дистрибьютором и эксклюзивным представителем в России производителя высокотехнологичных и надежных решений для передачи СВЧ сигналов «FORSTAR».



JONHON

«JONHON» (основан в 1970 г.)

Разъемы специального, военного и аэрокосмического назначения:

(Применяются в военной, авиационной, аэрокосмической, морской, железнодорожной, горно- и нефтедобывающей отраслях промышленности)

«FORSTAR» (основан в 1998 г.)

ВЧ соединители, коаксиальные кабели, кабельные сборки и микроволновые компоненты:

(Применяются в телекоммуникациях гражданского и специального назначения, в средствах связи, РЛС, а так же военной, авиационной и аэрокосмической отраслях промышленности).



Телефон: 8 (812) 309-75-97 (многоканальный)

Факс: 8 (812) 320-03-32

Электронная почта: ocean@oceanchips.ru

Web: <http://oceanchips.ru/>

Адрес: 198099, г. Санкт-Петербург, ул. Калинина, д. 2, корп. 4, лит. А