N-channel Load Switch IC

NO. EA-268-111028

OUTLINE

The R5540 series are N-channel Load Switch ICs with the low supply current, Typ. 9 μ A. By using an Nch transistor as a driver transistor, the features of low on resistance and the reverse current protection at off state are realized in these ICs. The gate voltage of the N-channel transistor is supplied from the internal step-up circuit. The R5540 is an ideal switch to supply the power from the secondary power source such as the output of a step-down DC/DC to the load circuit. Since the package for the R5540 is the ultra small-sized DFN(PLP)1010-4F, high density mounting on board is possible.

FEATURES

- Built-in an N-channel MOSFET
- Input Voltage Range 0.75V to 3.6V (Code 002)
..... 0.8V to 3.6V (Code 004)
- Supply Current at Operation ($I_{OUT}=0mA$) Typ. 9 μ A
- Supply Current at Standby Mode Typ. 0.7 μ A
- Switch On Resistance Typ. 120m Ω ($V_{IN}=1.2V$)
- Output Current Min. 200mA/ Min. 450mA
- Package DFN(PLP)1010-4F
- Built-in Over- current Sensing Circuit TYP. 350mA/ TYP. 700mA
- Built-in Soft-start function

APPLICATION

- For secondary power source for electrical appliances such as mobile communication equipments, cameras, VCRs and Camcorders.

BLOCK DIAGRAMS

R5540KxxxB

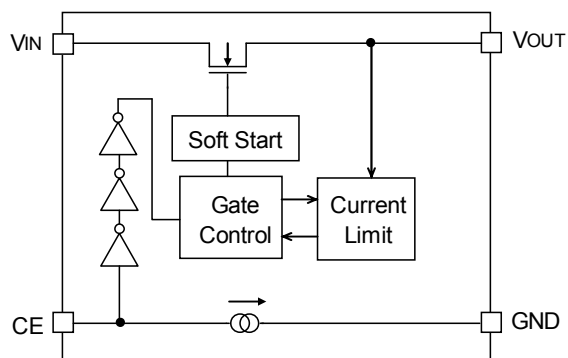

R5540KxxxC

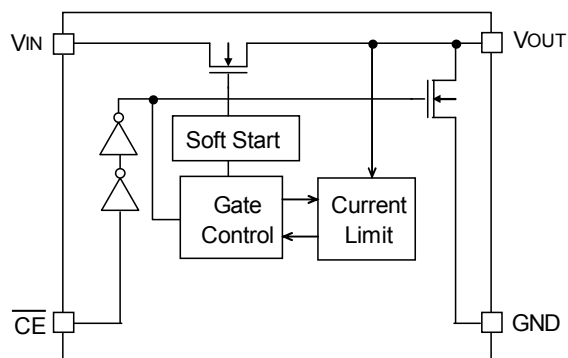

R5540KxxxD

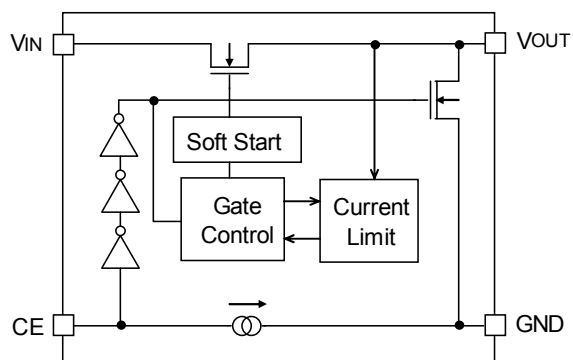

SELECTION GUIDE

The output current value, the auto-discharge function and the polarity of CE pin from "L" active, "H" active are selectable at the user's request.

Product Name	Package	Quantity per Reel	Pb Free	Halogen Free
R5540Kxxx*-TR	DFN(PLP)1010-4F	10,000pcs	Yes	Yes

xxx: The output current value can be designated by the following codes.

002: Output Current (200mA)

004: Output Current (450mA)

*: Auto-discharge function at off state and the polarity of CE pin are option as follows.

B: "H" active, without auto-discharge function at off state

C: "L" active, with auto-discharge function at off state

D: "H" active, with auto-discharge function at off state

PIN CONFIGURATIONS

• DFN(PLP)1010-4F

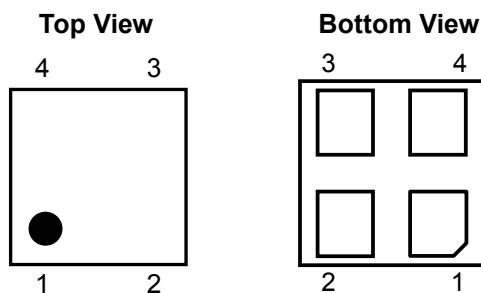

PIN DESCRIPTION

● R5540K : DFN(PLP)1010-4F

Pin No	Symbol	Pin Description
1	GND	Ground Pin
2	\overline{CE} / CE	Chip Enable Pin ("L" Active / "H" Active)
3	V_{IN}	Input Pin
4	V_{OUT}	Output Pin

ABSOLUTE MAXIMUM RATINGS

Symbol	Item	Rating	Unit
V_{IN}	Input Voltage	-0.3 to 5.0	V
V_{CE}	Input Voltage (\overline{CE} / CE Pin)	-0.3 to 5.0	V
V_{OUT}	Output Voltage	-0.3 to 5.0	V
I_{OUT}	Output Current	Internally limited	mA
P_D	Power Dissipation (Standard Test Land Pattern)*	300	mW
T_a	Ambient Temperature	-40 to 85	°C
T_{stg}	Storage Temperature	-55 to 125	°C

*) For Power Dissipation, please refer to Power Dissipation to be described.

ABSOLUTE MAXIMUM RATINGS

Electronic and mechanical stress momentarily exceeded absolute maximum ratings may cause the permanent damages and may degrade the life time and safety for both device and system using the device in the field. The functional operation at or over these absolute maximum ratings is not assured.

RECOMMENDED OPERATING CONDITIONS (ELECTRICAL CHARACTERISTICS)

All of electronic equipment should be designed that the mounted semiconductor devices operate within the recommended operating conditions. The semiconductor devices cannot operate normally over the recommended operating conditions, even if when they are used over such conditions by momentary electronic noise or surge. And the semiconductor devices may receive serious damage when they continue to operate over the recommended operating conditions.

ELECTRICAL CHARACTERISTICS

$V_{IN} = 0.75$ to $3.60V$ (Code 002) , 0.80 to $3.60V$ (Code 004), $C_{IN} = 1\mu F$, $C_{OUT} = \text{None}$, unless otherwise noted.

The specification in surrounded by is guaranteed by design at all temperature range, $-40^{\circ}C \leq T_a \leq 85^{\circ}C$.

R5540Kxxxx

($T_a=25^{\circ}C$)

Symbol	Item	Conditions		Min.	Typ.	Max.	Unit
V_{IN}	Input Voltage	Code 002		0.75		3.60	V
		Code 004		0.80		3.60	
R_{ON}	Switch ON Resistance	Code 002	$V_{IN}=1.2V, I_{OUT}=200mA$		120	180	$m\Omega$
		Code 004	$V_{IN}=1.2V, I_{OUT}=450mA$				
I_{OUT}	Output Current	Code 002		200			mA
I_{OUT}	Output Current	Code 004		450			
I_{SS}	Supply Current	$I_{OUT}=0mA$ *Note1			9	40	μA
$I_{standby}$	Standby Current	$V_{OUT}=GND$ $V_{IN}=1.8V$ *Note2	$T_a=25^{\circ}C$		0.7		μA
			$T_a=85^{\circ}C$		5		
I_{LIM}	Current Limit	Code 002	$V_{IN}=1.2V$	200	350	500	mA
I_{LIM}	Current Limit	Code 004		450	700	1000	
I_{SC}	Short Current Limit	$V_{IN}=1.2V, V_{OUT}=0V$			50	100	mA
I_{CE}	\overline{CE} Input Current	C version			0.4		μA
I_{CEPD}	CE Pull-down Current	B, D version			0.7		μA
V_{CEH}	CE Input Voltage "H"	$V_{IN}=2.5V$ to $3.6V$		1.0			V
		$V_{IN}=1.0V$ to $2.5V$		0.9			
		$V_{IN}=0.75V$ to $1.0V$		$V_{IN} \times 0.9$			
V_{CEL}	CE Input Voltage "L"	$V_{IN}=0.75V$ to $3.6V$				0.4	V
R_{LOW}	Auto-discharge Nch Tr. ON Resistance (Version. C, D)	$V_{IN}=1.2V$ *Note2			100		Ω
t_r	Output Rise Time	$V_{IN}=1.2V, V_{OUT}=10\% \sim 90\%$ $C_{OUT}=0.1\mu F$			73		μs
t_{sc}	Short Current Response Time	$V_{OUT}=0V$			30		μs

All test categories were tested on the units under the pulse load condition ($T_j \approx T_a = 25^{\circ}C$) except Short Current Response Time.

*Note1 $\overline{CE} = L$ for "L" active, $CE = H$ for "H" active

*Note2 $\overline{CE} = H$ for "L" active, $CE = L$ for "H" active

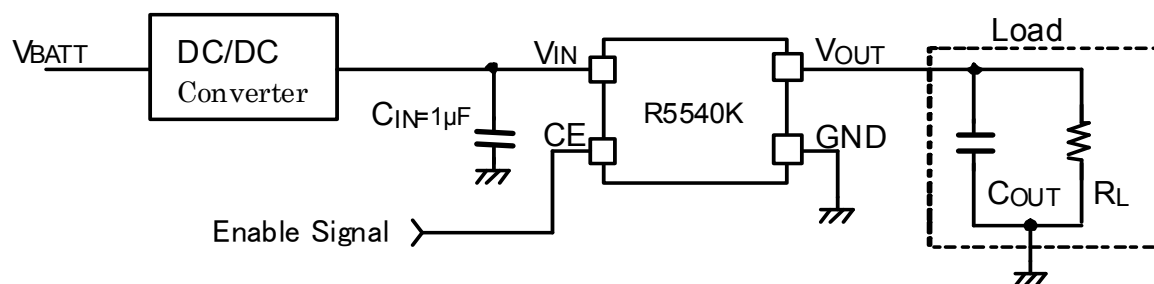
TYPICAL APPLICATION

Basically, the R5540K series do not require a bypass capacitor between V_{IN} and GND, however, considering the spike noise caused by the high side inductor at current limit, use 0.1µF or more capacitor as a bypass capacitor. More capacitance is also acceptable depending on the application.

TYPICAL CHARACTERISTIC

1) Output Voltage vs. Output Current $C_{IN}=1\mu F$, $C_{OUT}=1\mu F$

R5540K002x

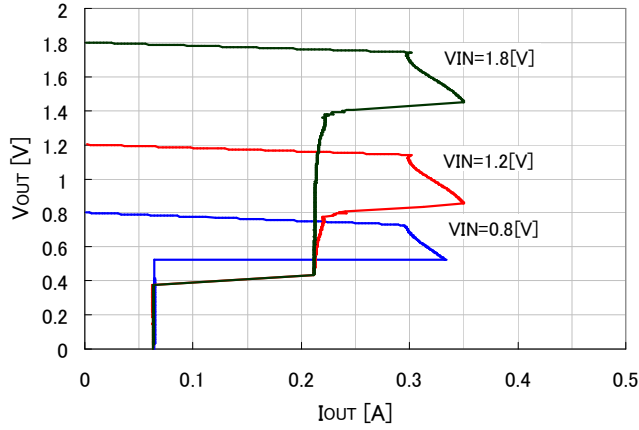

R5540K004x

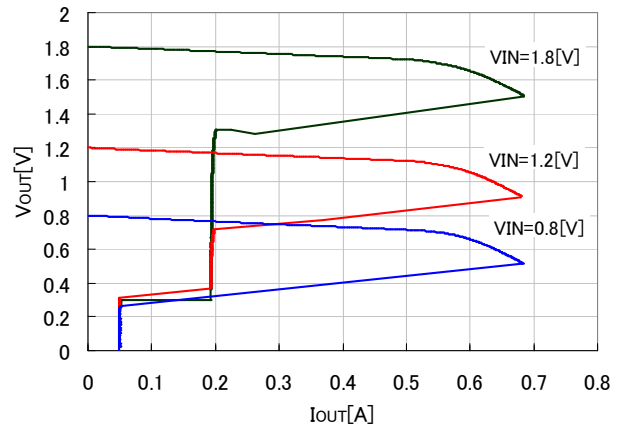

2) Turn on waveform (002x, $V_{IN}=1.2V$, $C_{IN}=1\mu F$, $T_a=25^\circ C$)

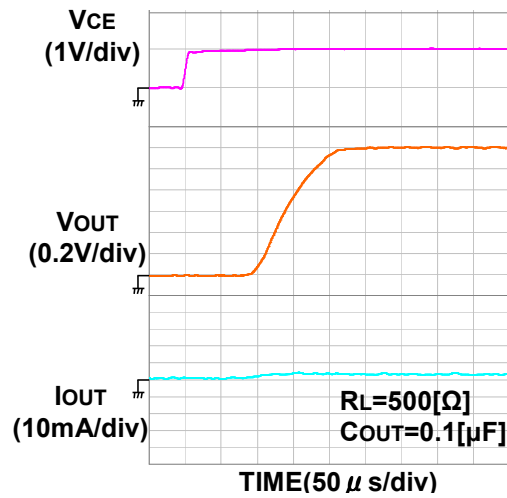
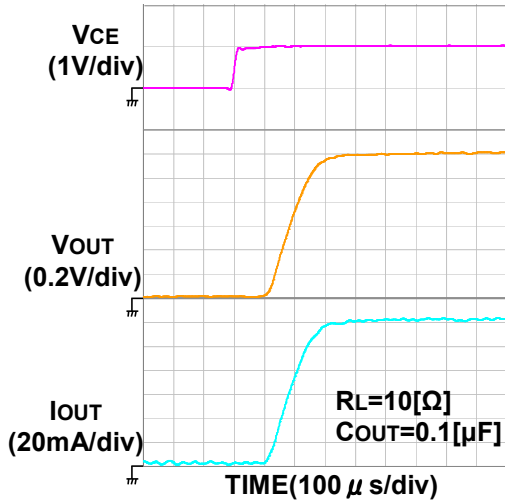

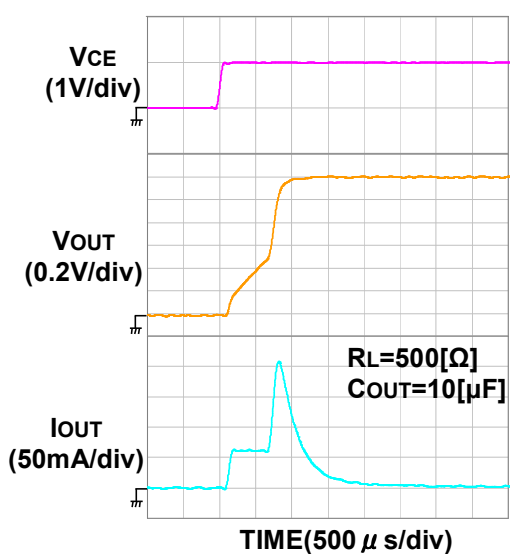
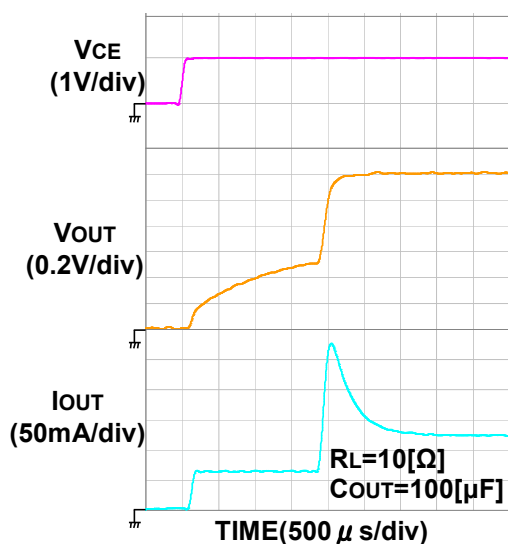
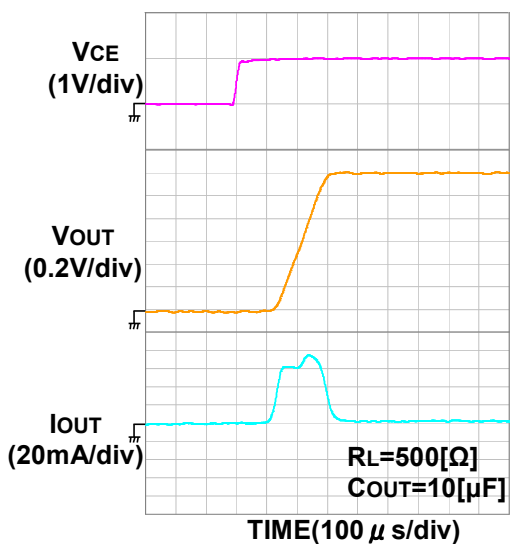
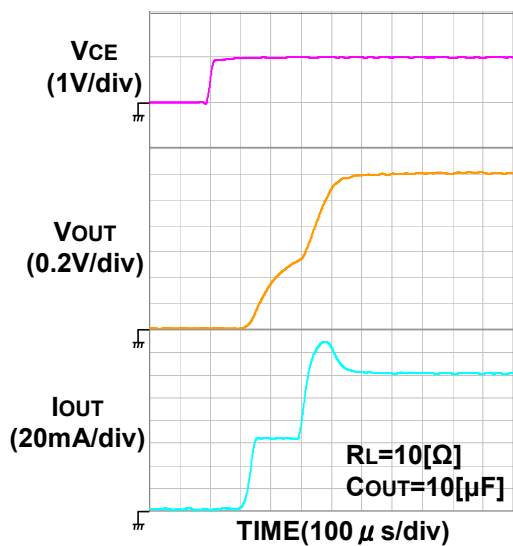
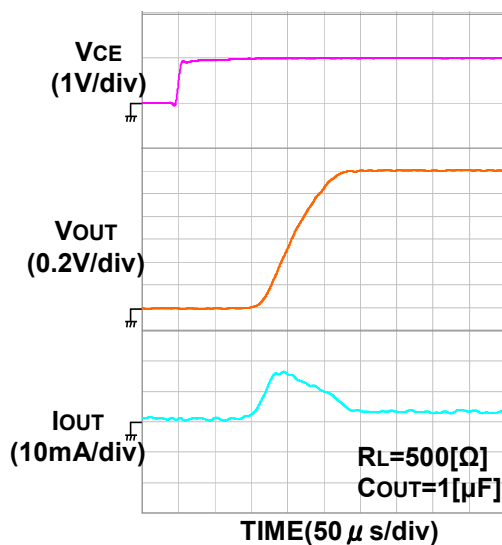
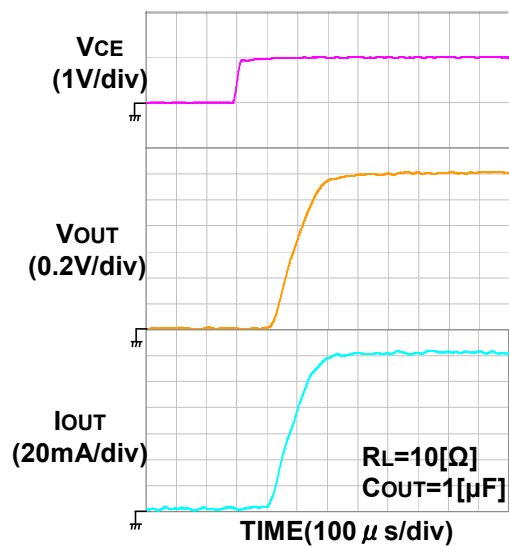

3) Inrush current vs. output capacitor (002x)

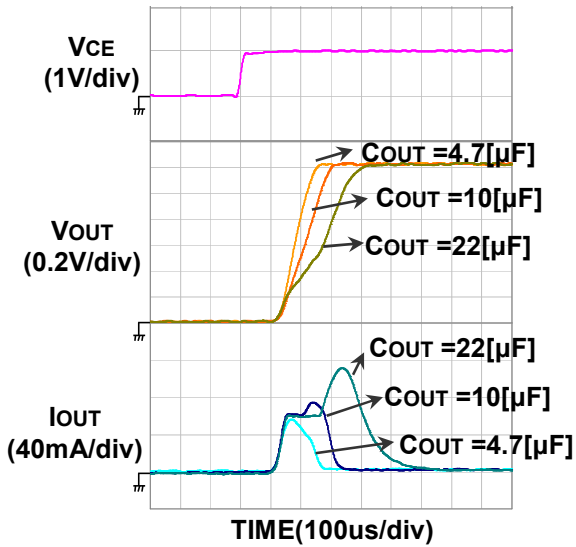

4) Input voltage vs. Turn-on speed

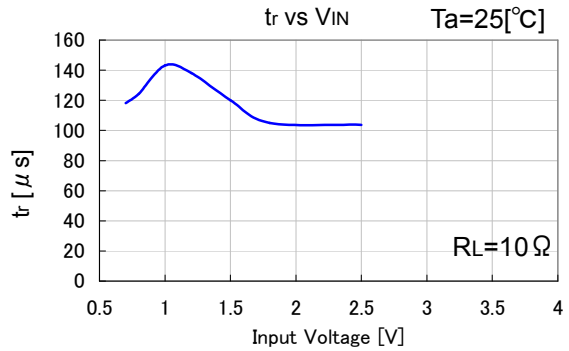

5) Supply current vs. Temperature

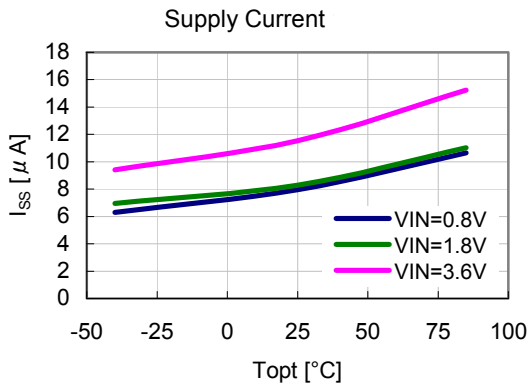

6) Standby current vs. Input voltage

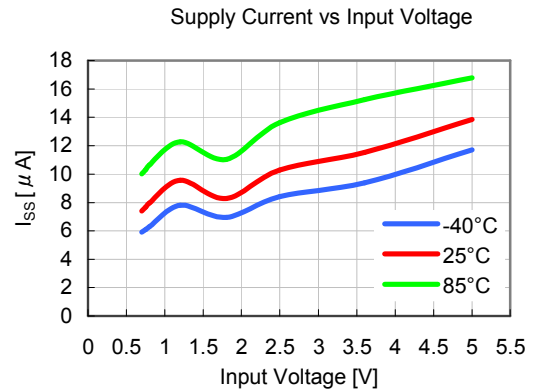

7) Standby Current vs. Temperature

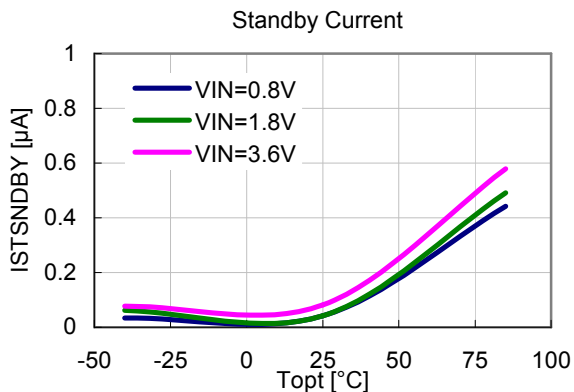

8) Standby current vs. Input voltage

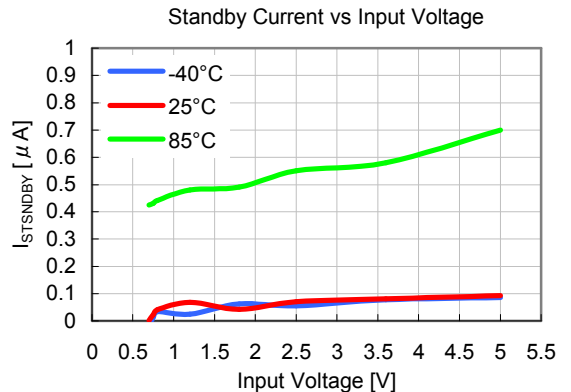

9) CE Input voltage "H" vs. Temperature

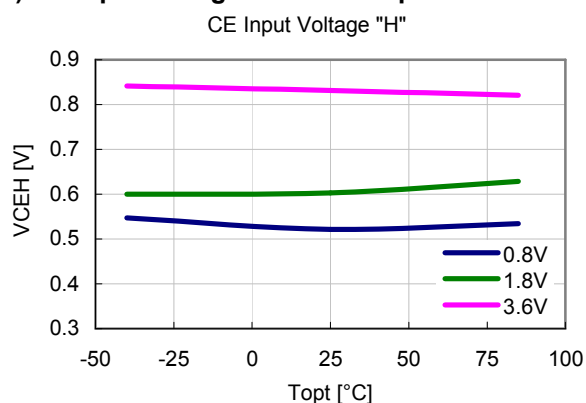

10) CE Input voltage "H" vs. VDD

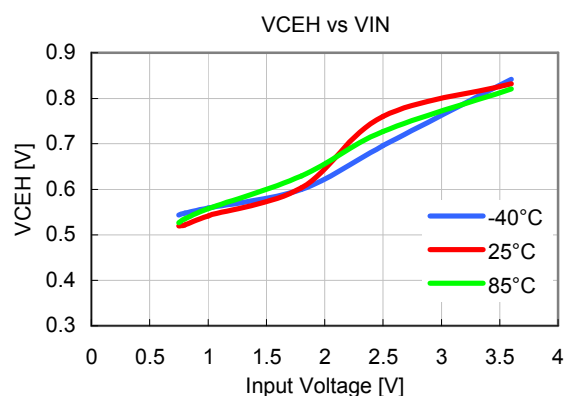

11) CE Input voltage "L" vs. Temperature

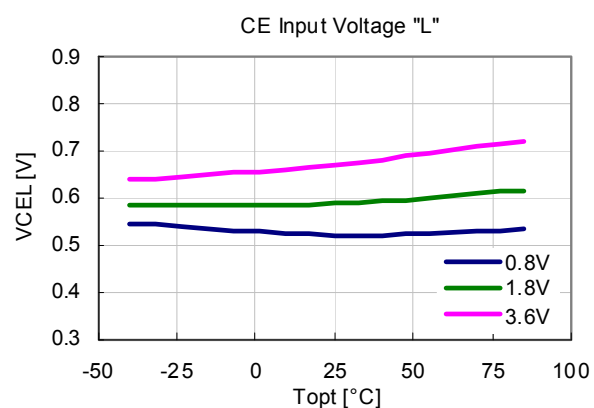

12) CE Input voltage "L" vs. VDD

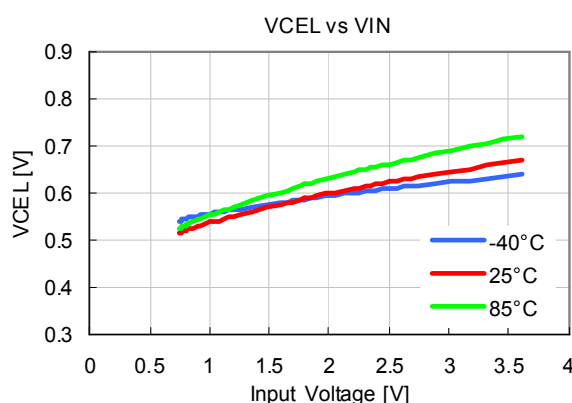

13) Short current limit vs. Temperature

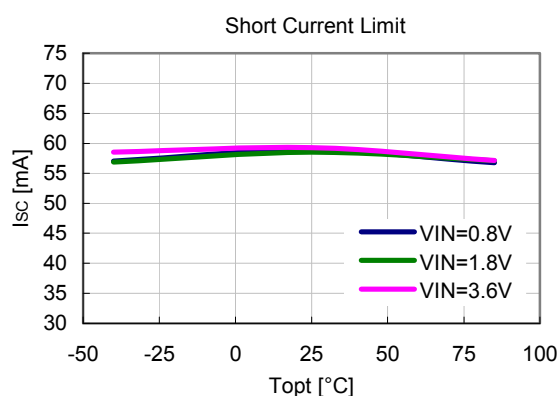

14) Short current limit vs. Input voltage

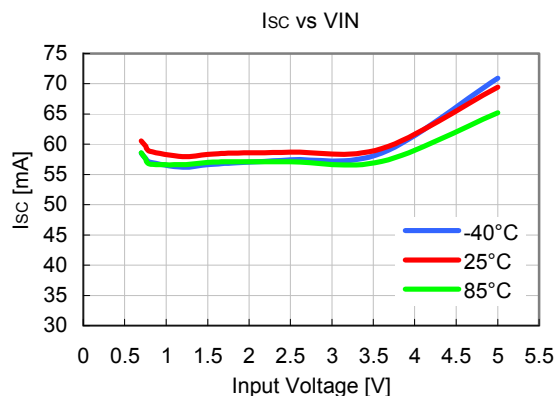

15) Switch on resistance vs. Temperature

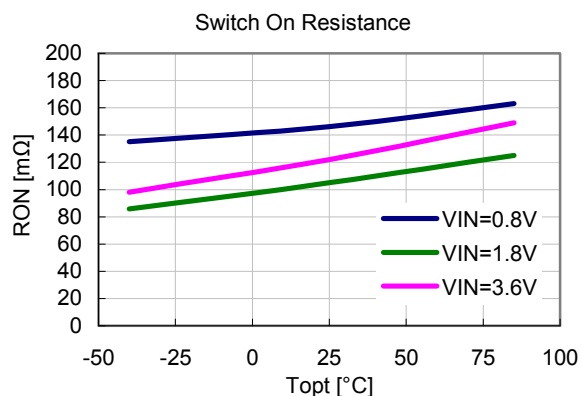

16) Switch on resistance vs. Input voltage

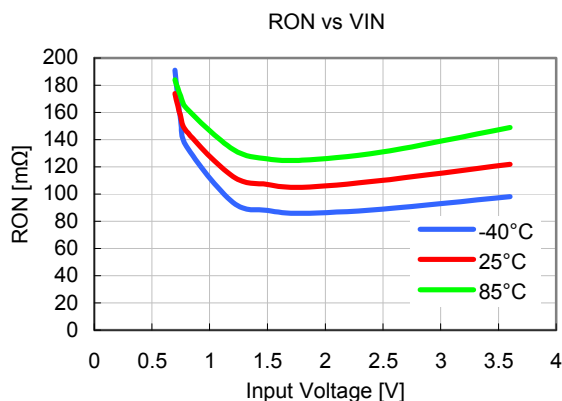

17) Output Rise time vs. Temperature

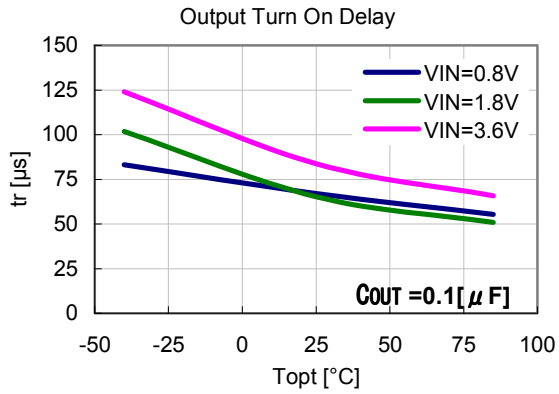

18) Output Rise time vs. Input voltage

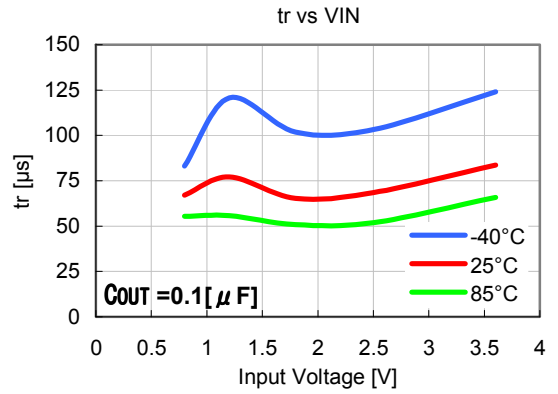

19) Output Fall time vs. Temperature

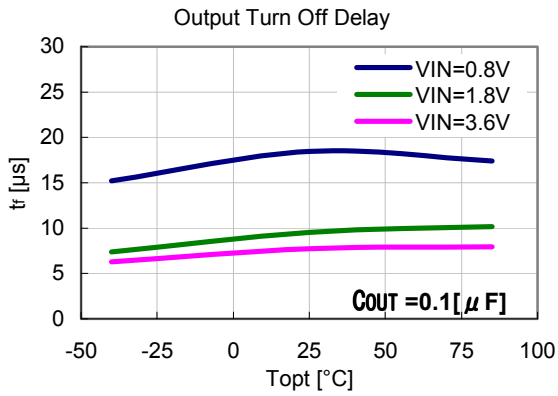

20) Output Fall time vs. Input voltage

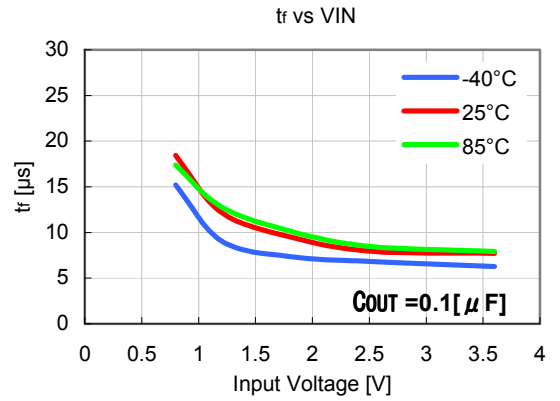

21) Reverse leakage current vs. Temperature

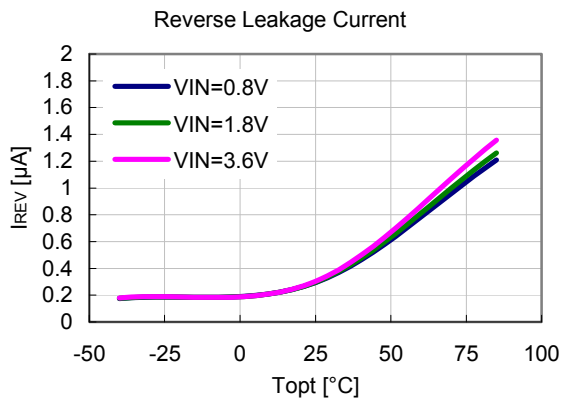

22) Reverse leakage current vs. Input voltage

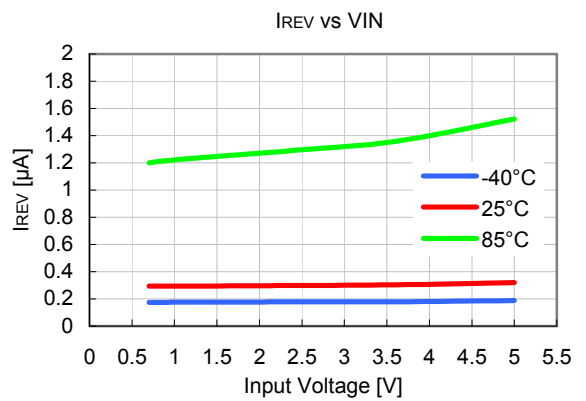

23) Discharge resistance vs. Temperature

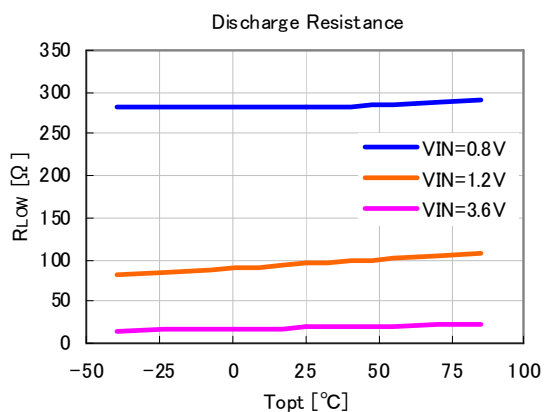

24) Discharge resistance vs. Input voltage

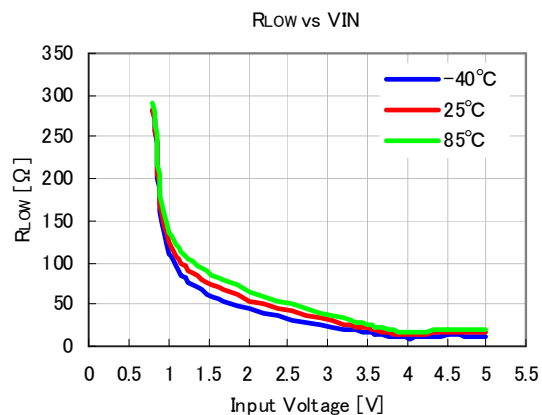

25) Current limit vs. Temperature (002x)

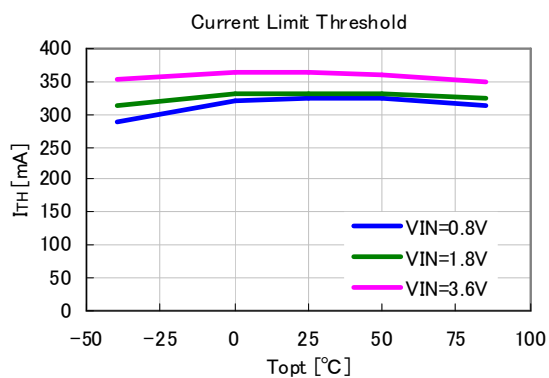

26) Current limit vs. Input voltage (002x)

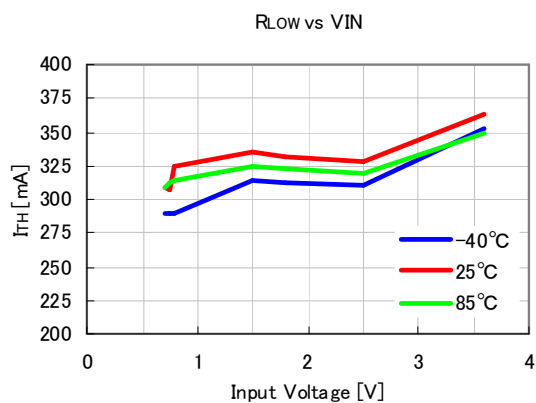

TIMING CHART

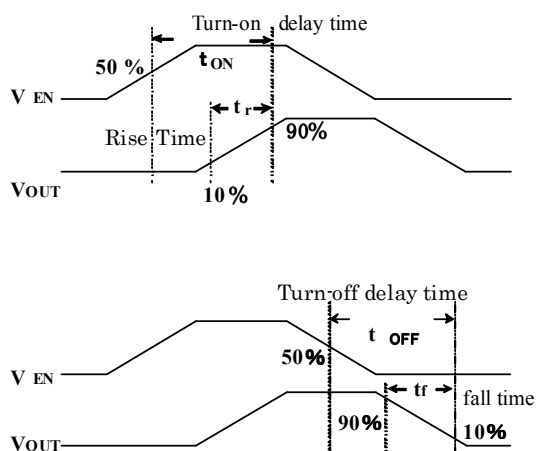

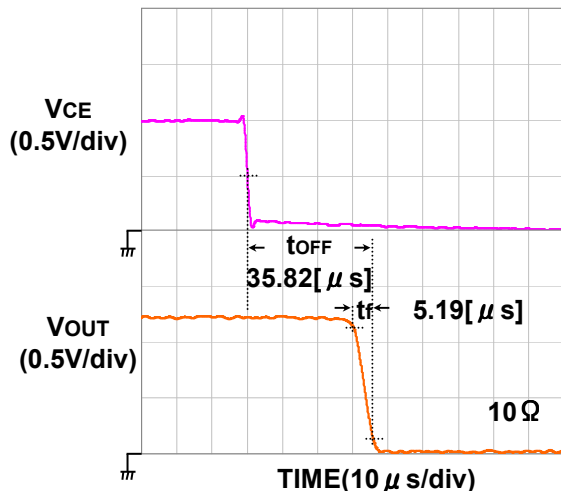
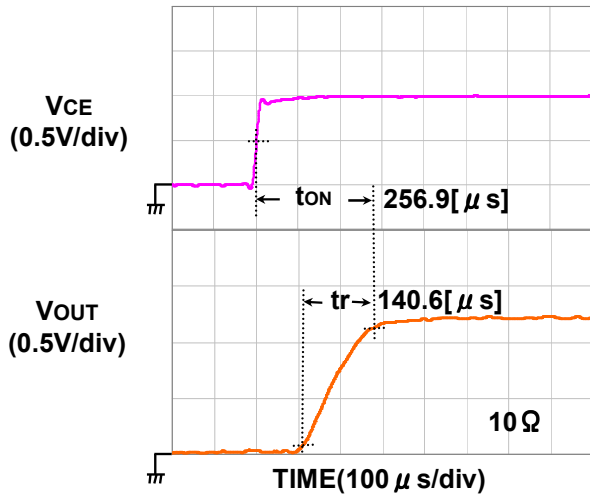
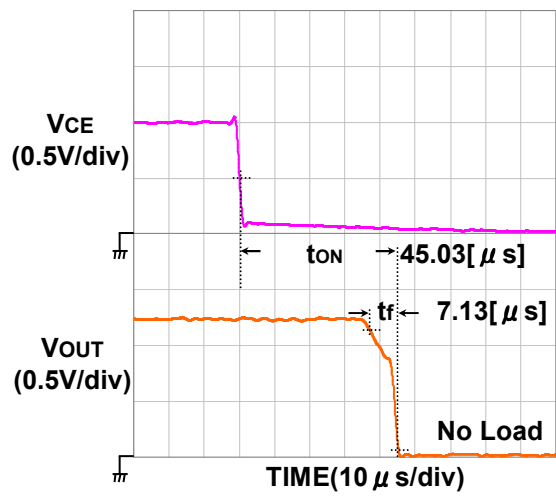
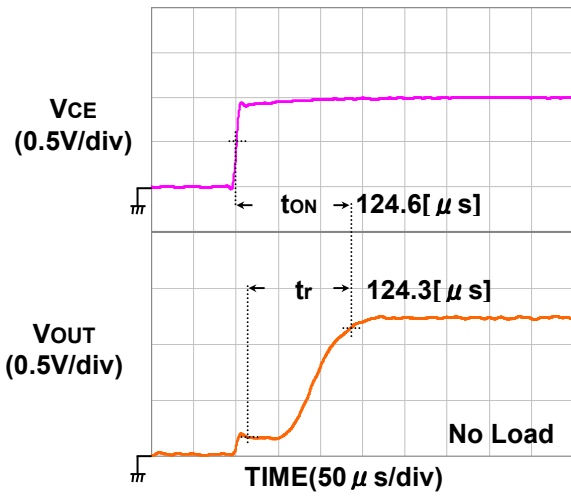
Turn-on/ turn-off waveform ($V_{IN} = 1.2[V]$)

POWER DISSIPATION (DFN(PLP)1010-4F)

Power Dissipation (P_D) depends on conditions of mounting on board. This specification is based on the measurement at the condition below:

Measurement Conditions

	Standard Land Pattern
Environment	Mounting on Board (Wind velocity=0m/s)
Board Material	Glass cloth epoxy plastic (Double sided)
Board Dimensions	40mm×40mm×1.6mm
Copper Ratio	Top side: Approx. 50%, Back side: Approx. 50%
Through-holes	φ 0.54mm×24pcs

Measurement Result

($T_a=25^{\circ}\text{C}$, $T_{j\text{max}}=125^{\circ}\text{C}$)

	Standard Land Pattern
Power Dissipation	300mW
Thermal Resistance	$\theta_{ja}=(125-25^{\circ}\text{C})/0.3\text{W}=330^{\circ}\text{C/W}$
	$\theta_{jc}=48^{\circ}\text{C/W}$

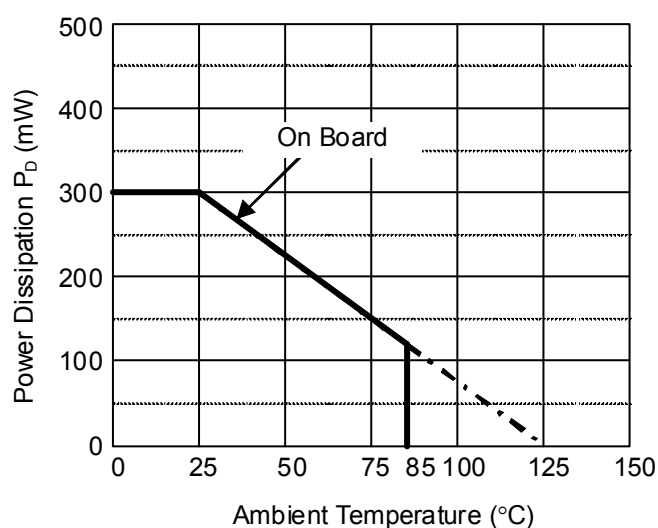

Power Dissipation

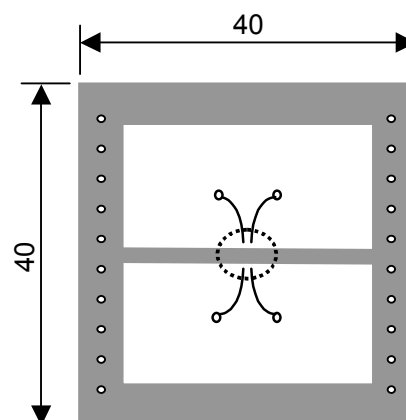

Measurement Board Pattern

○ IC Mount Area (Unit : mm)



1. The products and the product specifications described in this document are subject to change or discontinuation of production without notice for reasons such as improvement. Therefore, before deciding to use the products, please refer to Ricoh sales representatives for the latest information thereon.
2. The materials in this document may not be copied or otherwise reproduced in whole or in part without prior written consent of Ricoh.
3. Please be sure to take any necessary formalities under relevant laws or regulations before exporting or otherwise taking out of your country the products or the technical information described herein.
4. The technical information described in this document shows typical characteristics of and example application circuits for the products. The release of such information is not to be construed as a warranty of or a grant of license under Ricoh's or any third party's intellectual property rights or any other rights.
5. The products listed in this document are intended and designed for use as general electronic components in standard applications (office equipment, telecommunication equipment, measuring instruments, consumer electronic products, amusement equipment etc.). Those customers intending to use a product in an application requiring extreme quality and reliability, for example, in a highly specific application where the failure or misoperation of the product could result in human injury or death (aircraft, spacevehicle, nuclear reactor control system, traffic control system, automotive and transportation equipment, combustion equipment, safety devices, life support system etc.) should first contact us.
6. We are making our continuous effort to improve the quality and reliability of our products, but semiconductor products are likely to fail with certain probability. In order to prevent any injury to persons or damages to property resulting from such failure, customers should be careful enough to incorporate safety measures in their design, such as redundancy feature, fire containment feature and fail-safe feature. We do not assume any liability or responsibility for any loss or damage arising from misuse or inappropriate use of the products.
7. Anti-radiation design is not implemented in the products described in this document.
8. Please contact Ricoh sales representatives should you have any questions or comments concerning the products or the technical information.



Ricoh is committed to reducing the environmental loading materials in electrical devices with a view to contributing to the protection of human health and the environment.

Ricoh has been providing RoHS compliant products since April 1, 2006 and Halogen-free products since April 1, 2012.

RICOH RICOH ELECTRONIC DEVICES CO., LTD.

<http://www.e-devices.ricoh.co.jp/en/>

Sales & Support Offices

RICOH ELECTRONIC DEVICES CO., LTD.

Higashi-Shinagawa Office (International Sales)
3-32-3, Higashi-Shinagawa, Shinagawa-ku, Tokyo 140-8655, Japan
Phone: +81-3-5479-2857 Fax: +81-3-5479-0502

RICOH EUROPE (NETHERLANDS) B.V.

Semiconductor Support Centre
Prof. W.H. Keesomlaan 1, 1183 DJ Amstelveen, The Netherlands
Phone: +31-20-5474-309

RICOH ELECTRONIC DEVICES KOREA CO., LTD.

3F, Haesung Bldg. 504, Teheran-ro, Gangnam-gu, Seoul, 135-725, Korea
Phone: +82-2-2135-5700 Fax: +82-2-2051-5713

RICOH ELECTRONIC DEVICES SHANGHAI CO., LTD.

Room 403, No.2 Building, No.690 Bibo Road, Pu Dong New District, Shanghai 201203,
People's Republic of China
Phone: +86-21-5027-3200 Fax: +86-21-5027-3299

RICOH ELECTRONIC DEVICES CO., LTD.

Taipei office
Room 109, 10F-1, No.51, Hengyang Rd., Taipei City, Taiwan (R.O.C.)
Phone: +886-2-2313-1621/1622 Fax: +886-2-2313-1623

Mouser Electronics

Authorized Distributor

Click to View Pricing, Inventory, Delivery & Lifecycle Information:

[Rico Electronics:](#)

[R5540K002C-TR](#) [R5540K002D-TR](#) [R5540K004B-TR](#) [R5540K002B-TR](#) [R5540K004C-TR](#) [R5540K004D-TR](#)

Компания «Океан Электроники» предлагает заключение долгосрочных отношений при поставках импортных электронных компонентов на взаимовыгодных условиях!

Наши преимущества:

- Поставка оригинальных импортных электронных компонентов напрямую с производств Америки, Европы и Азии, а так же с крупнейших складов мира;
- Широкая линейка поставок активных и пассивных импортных электронных компонентов (более 30 млн. наименований);
- Поставка сложных, дефицитных, либо снятых с производства позиций;
- Оперативные сроки поставки под заказ (от 5 рабочих дней);
- Экспресс доставка в любую точку России;
- Помощь Конструкторского Отдела и консультации квалифицированных инженеров;
- Техническая поддержка проекта, помощь в подборе аналогов, поставка прототипов;
- Поставка электронных компонентов под контролем ВП;
- Система менеджмента качества сертифицирована по Международному стандарту ISO 9001;
- При необходимости вся продукция военного и аэрокосмического назначения проходит испытания и сертификацию в лаборатории (по согласованию с заказчиком);
- Поставка специализированных компонентов военного и аэрокосмического уровня качества (Xilinx, Altera, Analog Devices, Intersil, Interpoint, Microsemi, Actel, Aeroflex, Peregrine, VPT, Syfer, Eurofarad, Texas Instruments, MS Kennedy, Miteq, Cobham, E2V, MA-COM, Hittite, Mini-Circuits, General Dynamics и др.);

Компания «Океан Электроники» является официальным дистрибьютором и эксклюзивным представителем в России одного из крупнейших производителей разъемов военного и аэрокосмического назначения «JONHON», а так же официальным дистрибьютором и эксклюзивным представителем в России производителя высокотехнологичных и надежных решений для передачи СВЧ сигналов «FORSTAR».



JONHON

«JONHON» (основан в 1970 г.)

Разъемы специального, военного и аэрокосмического назначения:

(Применяются в военной, авиационной, аэрокосмической, морской, железнодорожной, горно- и нефтедобывающей отраслях промышленности)

«FORSTAR» (основан в 1998 г.)

ВЧ соединители, коаксиальные кабели,
кабельные сборки и микроволновые компоненты:

(Применяются в телекоммуникациях гражданского и специального назначения, в средствах связи, РЛС, а так же военной, авиационной и аэрокосмической отраслях промышленности).



Телефон: 8 (812) 309-75-97 (многоканальный)

Факс: 8 (812) 320-03-32

Электронная почта: ocean@oceanchips.ru

Web: <http://oceanchips.ru/>

Адрес: 198099, г. Санкт-Петербург, ул. Калинина, д. 2, корп. 4, лит. А