

## FEATURES

- Floating Top Driver Switches Up to 60V
- Drives Gate of Top N-Channel MOSFET above Load HV Supply
- 180ns Transition Times Driving 10,000pF
- Adaptive Nonoverlapping Gate Drives Prevent Shoot-Through
- Top Drive Protection at High Duty Cycles
- TTL/CMOS Input Levels
- Undervoltage Lockout with Hysteresis
- Operates at Supply Voltages from 10V to 15V
- Separate Top and Bottom Drive Pins

## APPLICATIONS

- PWM of High Current Inductive Loads
- Half-Bridge and Full-Bridge Motor Control
- Synchronous Step-Down Switching Regulators
- 3-Phase Brushless Motor Drive
- High Current Transducer Drivers
- Class D Power Amplifiers

## DESCRIPTION

The LT<sup>®</sup>1160/LT1162 are cost effective half-/full-bridge N-channel power MOSFET drivers. The floating driver can drive the topline N-channel power MOSFETs operating off a high voltage (HV) rail of up to 60V.

The internal logic prevents the inputs from turning on the power MOSFETs in a half-bridge at the same time. Its unique adaptive protection against shoot-through currents eliminates all matching requirements for the two MOSFETs. This greatly eases the design of high efficiency motor control and switching regulator systems.

During low supply or start-up conditions, the undervoltage lockout actively pulls the driver outputs low to prevent the power MOSFETs from being partially turned on. The 0.5V hysteresis allows reliable operation even with slowly varying supplies.

The LT1162 is a dual version of the LT1160 and is available in a 24-pin PDIP or in a 24-pin SO Wide package.

LT, LT, LTC and LTM are registered trademarks of Linear Technology Corporation. All other trademarks are the property of their respective owners.

## TYPICAL APPLICATION



IN TOP	IN BOTTOM	T GATE DR	B GATE DR
L	L	L	L
L	H	L	H
H	L	H	L
H	H	L	L

1160 TA01

11602fb

## ABSOLUTE MAXIMUM RATINGS (Note 1)

Supply Voltage (Note 2) .....	20V	Operating Temperature Range	
Boost Voltage .....	75V	Commercial .....	0°C to 70°C
Peak Output Currents (< 10μs) .....	1.5A	Industrial .....	-40°C to 85°C
Input Pin Voltages .....	-0.3V to V <sup>+</sup> + 0.3V	Junction Temperature (Note 3) .....	125°C
Top Source Voltage .....	-5V to 60V	Storage Temperature Range .....	-65°C to 150°C
Boost to Source Voltage .....	-0.3V to 20V	Lead Temperature (Soldering, 10 sec) .....	300°C

## PACKAGE/ORDER INFORMATION

<p>TOP VIEW</p> <p>SV<sup>+</sup> 1, IN TOP 2, IN BOTTOM 3, UV OUT 4, SGND 5, PGND 6, NC 7, BOOST 14, T GATE DR 13, T GATE FB 12, T SOURCE 11, PV<sup>+</sup> 10, B GATE DR 9, B GATE FB 8</p> <p>N PACKAGE 14-LEAD PDIP</p> <p>S PACKAGE 14-LEAD PLASTIC SO</p> <p>T<sub>JMAX</sub> = 125°C, θ<sub>JA</sub> = 70°C/W (N) T<sub>JMAX</sub> = 125°C, θ<sub>JA</sub> = 110°C/W (S)</p>	ORDER PART NUMBER	<p>TOP VIEW</p> <p>SV<sup>+</sup> A 1, IN TOP A 2, IN BOTTOM A 3, UV OUT A 4, GND A 5, B GATE FB A 6, SV<sup>+</sup> B 7, IN TOP B 8, IN BOTTOM B 9, UV OUT B 10, GND B 11, B GATE FB B 12, BOOST A 24, T GATE DR A 23, T GATE FB A 22, T SOURCE A 21, PV<sup>+</sup> A 20, B GATE DR A 19, BOOST B 18, T GATE DR B 17, T GATE FB B 16, T SOURCE B 15, PV<sup>+</sup> B 14, B GATE DR B 13</p> <p>N PACKAGE 24-LEAD PDIP</p> <p>SW PACKAGE 24-LEAD PLASTIC SO WIDE</p> <p>T<sub>JMAX</sub> = 125°C, θ<sub>JA</sub> = 58°C/W (N) T<sub>JMAX</sub> = 125°C, θ<sub>JA</sub> = 80°C/W (SW)</p>	ORDER PART NUMBER
	<p>LT1160CN LT1160CS LT1160IN LT1160IS</p>		<p>LT1162CSW LT1162ISW</p>
<b>OBSOLETE PART NUMBERS</b>			
			<p>LT1162CN LT1162IN</p>

Consult LTC Marketing for parts specified with wider operating temperature ranges.

## ELECTRICAL CHARACTERISTICS

The ● denotes the specifications which apply over the full operating temperature range, otherwise specifications are at T<sub>A</sub> = 25°C. Test Circuit, T<sub>A</sub> = 25°C, V<sup>+</sup> = V<sub>BOOST</sub> = 12V, V<sub>TSOURCE</sub> = 0V, C<sub>GATE</sub> = 3000pF. Gate Feedback pins connected to Gate Drive pins, unless otherwise specified.

SYMBOL	PARAMETER	CONDITIONS	MIN	TYP	MAX	UNITS
I <sub>S</sub>	DC Supply Current (Note 4)	V <sup>+</sup> = 15V, V <sub>INTOP</sub> = 0.8V, V <sub>INBOTTOM</sub> = 2V V <sup>+</sup> = 15V, V <sub>INTOP</sub> = 2V, V <sub>INBOTTOM</sub> = 0.8V V <sup>+</sup> = 15V, V <sub>INTOP</sub> = 0.8V, V <sub>INBOTTOM</sub> = 0.8V	7	11	15	mA
I <sub>BOOST</sub>	Boost Current (Note 4)	V <sup>+</sup> = 15V, V <sub>TSOURCE</sub> = 60V, V <sub>BOOST</sub> = 75V, V <sub>INTOP</sub> = V <sub>INBOTTOM</sub> = 0.8V	3	4.5	6	mA
V <sub>IL</sub>	Input Logic Low	●		1.4	0.8	V
V <sub>IH</sub>	Input Logic High	●	2	1.7		V
I <sub>IN</sub>	Input Current	V <sub>INTOP</sub> = V <sub>INBOTTOM</sub> = 4V ●		7	25	μA
V <sup>+</sup> <sub>UVH</sub>	V <sup>+</sup> Undervoltage Start-Up Threshold		8.4	8.9	9.7	V
V <sup>+</sup> <sub>UVL</sub>	V <sup>+</sup> Undervoltage Shutdown Threshold		7.8	8.3	8.8	V
V <sub>BUVH</sub>	V <sub>BOOST</sub> Undervoltage Start-Up Threshold	V <sub>TSOURCE</sub> = 60V (V <sub>BOOST</sub> - V <sub>TSOURCE</sub> )	8.8	9.3	9.8	V
V <sub>BUVL</sub>	V <sub>BOOST</sub> Undervoltage Shutdown Threshold	V <sub>TSOURCE</sub> = 60V (V <sub>BOOST</sub> - V <sub>TSOURCE</sub> )	8.2	8.7	9.2	V

**ELECTRICAL CHARACTERISTICS** The ● denotes the specifications which apply over the full operating temperature range, otherwise specifications are at  $T_A = 25^\circ\text{C}$ . Test Circuit,  $T_A = 25^\circ\text{C}$ ,  $V^+ = V_{\text{BOOST}} = 12\text{V}$ ,  $V_{\text{TSOURCE}} = 0\text{V}$ ,  $C_{\text{GATE}} = 3000\text{pF}$ . Gate Feedback pins connected to Gate Drive pins, unless otherwise specified.

SYMBOL	PARAMETER	CONDITIONS	MIN	TYP	MAX	UNITS	
$I_{\text{UVOUT}}$	Undervoltage Output Leakage	$V^+ = 15\text{V}$	●	0.1	5	$\mu\text{A}$	
$V_{\text{UVOUT}}$	Undervoltage Output Saturation	$V^+ = 7.5\text{V}$ , $I_{\text{UVOUT}} = 2.5\text{mA}$	●	0.2	0.4	V	
$V_{\text{OH}}$	Top Gate ON Voltage	$V_{\text{INTOP}} = 2\text{V}$ , $V_{\text{INBOTTOM}} = 0.8\text{V}$	●	11	11.3	12	V
	Bottom Gate ON Voltage	$V_{\text{INTOP}} = 0.8\text{V}$ , $V_{\text{INBOTTOM}} = 2\text{V}$	●	11	11.3	12	V
$V_{\text{OL}}$	Top Gate OFF Voltage	$V_{\text{INTOP}} = 0.8\text{V}$ , $V_{\text{INBOTTOM}} = 2\text{V}$	●	0.4	0.7	V	
	Bottom Gate OFF Voltage	$V_{\text{INTOP}} = 2\text{V}$ , $V_{\text{INBOTTOM}} = 0.8\text{V}$	●	0.4	0.7	V	
$t_r$	Top Gate Rise Time	$V_{\text{INTOP}}$ (+) Transition, $V_{\text{INBOTTOM}} = 0.8\text{V}$ , Measured at $V_{\text{TGATE DR}}$ (Note 5)	●	130	200	ns	
	Bottom Gate Rise Time	$V_{\text{INBOTTOM}}$ (+) Transition, $V_{\text{INTOP}} = 0.8\text{V}$ , Measured at $V_{\text{BGATE DR}}$ (Note 5)	●	90	200	ns	
$t_f$	Top Gate Fall Time	$V_{\text{INTOP}}$ (-) Transition, $V_{\text{INBOTTOM}} = 0.8\text{V}$ , Measured at $V_{\text{TGATE DR}}$ (Note 5)	●	60	140	ns	
	Bottom Gate Fall Time	$V_{\text{INBOTTOM}}$ (-) Transition, $V_{\text{INTOP}} = 0.8\text{V}$ , Measured at $V_{\text{BGATE DR}}$ (Note 5)	●	60	140	ns	
$t_{\text{D1}}$	Top Gate Turn-On Delay	$V_{\text{INTOP}}$ (+) Transition, $V_{\text{INBOTTOM}} = 0.8\text{V}$ , Measured at $V_{\text{TGATE DR}}$ (Note 5)	●	250	500	ns	
	Bottom Gate Turn-On Delay	$V_{\text{INBOTTOM}}$ (+) Transition, $V_{\text{INTOP}} = 0.8\text{V}$ , Measured at $V_{\text{BGATE DR}}$ (Note 5)	●	200	400	ns	
$t_{\text{D2}}$	Top Gate Turn-Off Delay	$V_{\text{INTOP}}$ (-) Transition, $V_{\text{INBOTTOM}} = 0.8\text{V}$ , Measured at $V_{\text{TGATE DR}}$ (Note 5)	●	300	600	ns	
	Bottom Gate Turn-Off Delay	$V_{\text{INBOTTOM}}$ (-) Transition, $V_{\text{INTOP}} = 0.8\text{V}$ , Measured at $V_{\text{BGATE DR}}$ (Note 5)	●	200	400	ns	
$t_{\text{D3}}$	Top Gate Lockout Delay	$V_{\text{INBOTTOM}}$ (+) Transition, $V_{\text{INTOP}} = 2\text{V}$ , Measured at $V_{\text{TGATE DR}}$ (Note 5)	●	300	600	ns	
	Bottom Gate Lockout Delay	$V_{\text{INTOP}}$ (+) Transition, $V_{\text{INBOTTOM}} = 2\text{V}$ , Measured at $V_{\text{BGATE DR}}$ (Note 5)	●	250	500	ns	
$t_{\text{D4}}$	Top Gate Release Delay	$V_{\text{INBOTTOM}}$ (-) Transition, $V_{\text{INTOP}} = 2\text{V}$ , Measured at $V_{\text{TGATE DR}}$ (Note 5)	●	250	500	ns	
	Bottom Gate Release Delay	$V_{\text{INTOP}}$ (-) Transition, $V_{\text{INBOTTOM}} = 2\text{V}$ , Measured at $V_{\text{BGATE DR}}$ (Note 5)	●	200	400	ns	

**Note 1:** Stresses beyond those listed under Absolute Maximum Ratings may cause permanent damage to the device. Exposure to any Absolute Maximum Rating condition for extended periods may affect device reliability and lifetime.

**Note 2:** For the LT1160, Pins 1, 10 should be connected together. For the LT1162, Pins 1, 7, 14, 20 should be connected together.

**Note 3:**  $T_J$  is calculated from the ambient temperature  $T_A$  and power dissipation  $P_D$  according to the following formulas:

$$\begin{aligned} \text{LT1160CN/LT1160IN: } T_J &= T_A + (P_D)(70^\circ\text{C/W}) \\ \text{LT1160CS/LT1160IS: } T_J &= T_A + (P_D)(110^\circ\text{C/W}) \\ \text{LT1162CN/LT1162IN: } T_J &= T_A + (P_D)(58^\circ\text{C/W}) \\ \text{LT1162CS/LT1162IS: } T_J &= T_A + (P_D)(80^\circ\text{C/W}) \end{aligned}$$

**Note 4:**  $I_S$  is the sum of currents through  $SV^+$ ,  $PV^+$  and Boost pins.  $I_{\text{BOOST}}$  is the current through the Boost pin. Dynamic supply current is higher due to the gate charge being delivered at the switching frequency. See Typical Performance Characteristics and Applications Information sections. The LT1160 = 1/2 LT1162.

**Note 5:** See Timing Diagram. Gate rise times are measured from 2V to 10V and fall times are measured from 10V to 2V. Delay times are measured from the input transition to when the gate voltage has risen to 2V or decreased to 10V.

**TYPICAL PERFORMANCE CHARACTERISTICS** (LT1160 or 1/2 LT1162)

**DC Supply Current vs Supply Voltage**

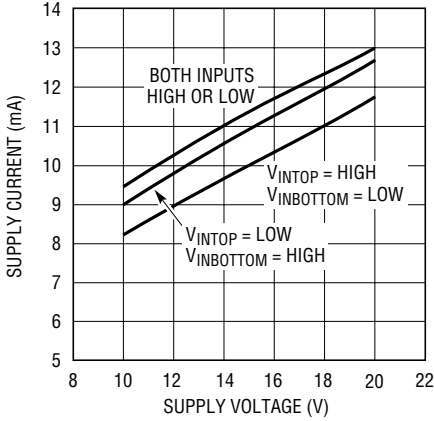

1160/62 G01

**DC Supply Current vs Temperature**

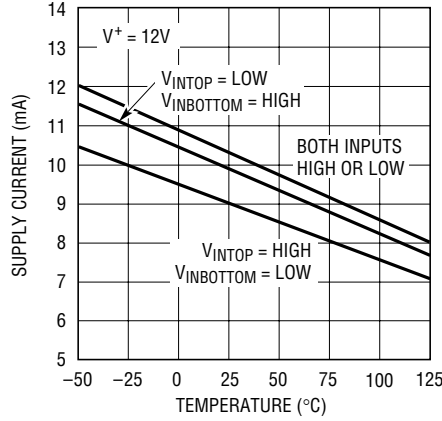

1160/62 G02

**DC + Dynamic Supply Current vs Input Frequency**

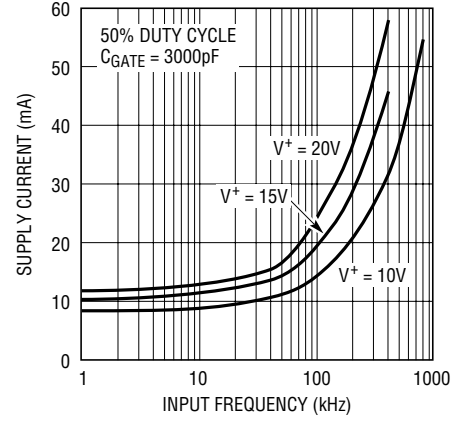

1160/62 G03

**DC + Dynamic Supply Current vs Input Frequency**

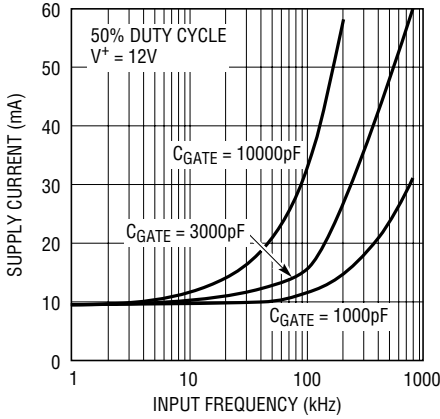

1160/62 G04

**Undervoltage Lockout (V+)**

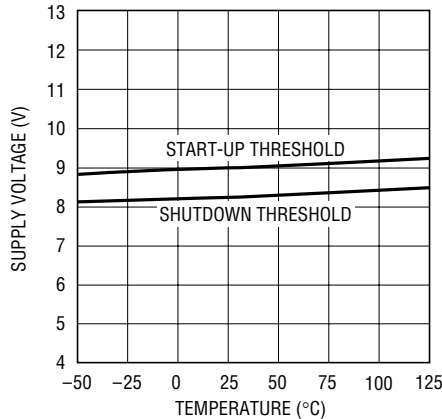

1160/62 G05

**Undervoltage Lockout (VBOOST)**

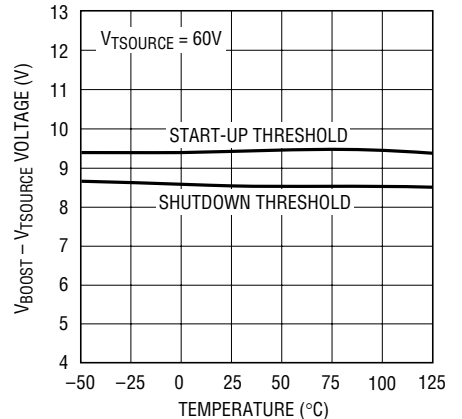

1160/62 G06

**Input Threshold Voltage vs Temperature**

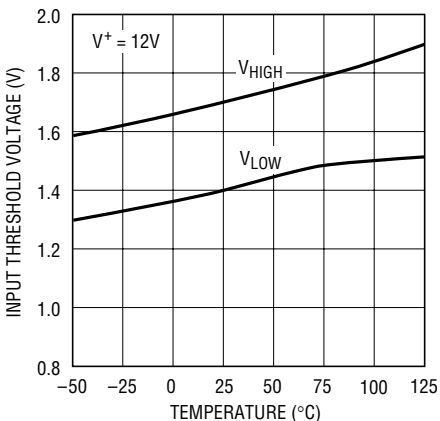

1160/62 G07

**Top or Bottom Input Pin Current vs Temperature**

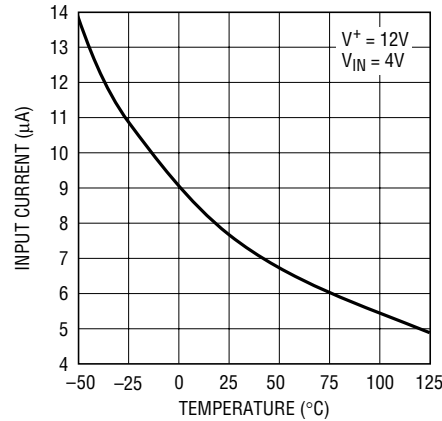

1160/62 G08

**Top or Bottom Input Pin Current vs Input Voltage**

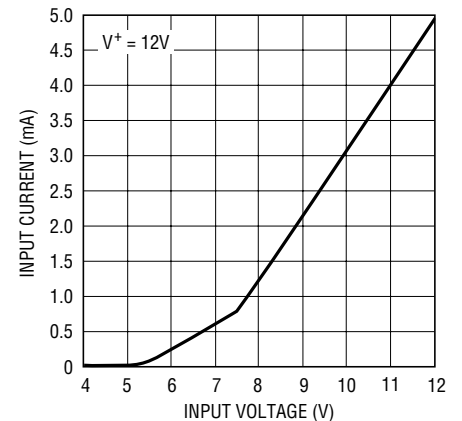

1160/62 G09

# TYPICAL PERFORMANCE CHARACTERISTICS (LT1160 or 1/2 LT1162)

**Bottom Gate Rise Time vs Temperature**

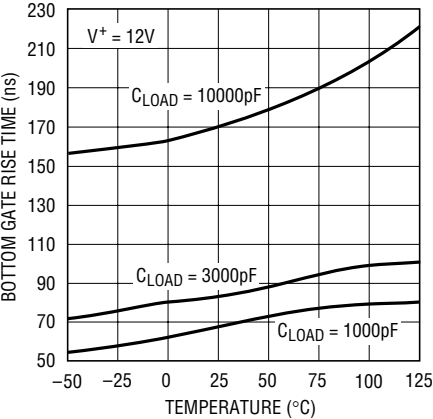

1160/62 G10

**Bottom Gate Fall Time vs Temperature**

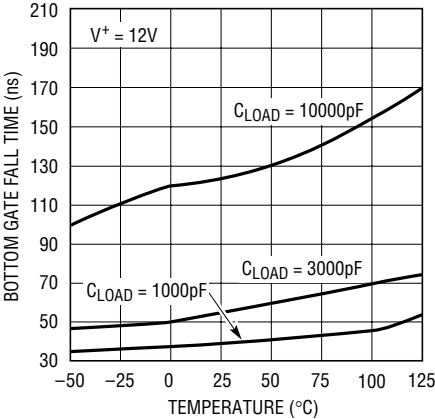

1160/62 G11

**Top Gate Rise Time vs Temperature**

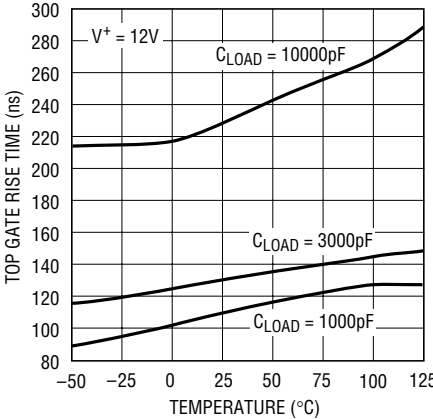

1160/62 G12

**Top Gate Fall Time vs Temperature**

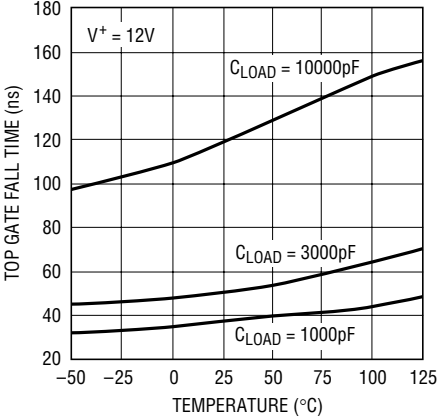

1160/62 G13

**Turn-On Delay Time vs Temperature**

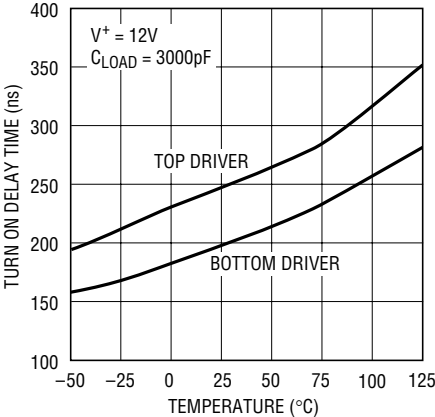

1160/62 G14

**Turn-Off Delay Time vs Temperature**

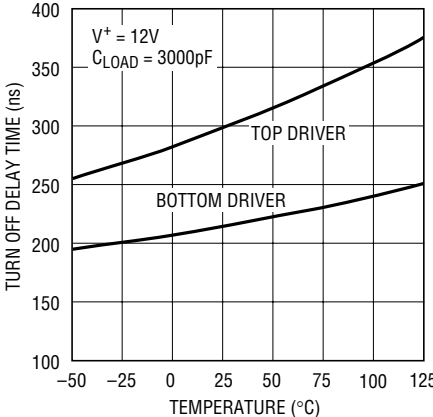

1160/62 G15

**Lockout Delay Time vs Temperature**

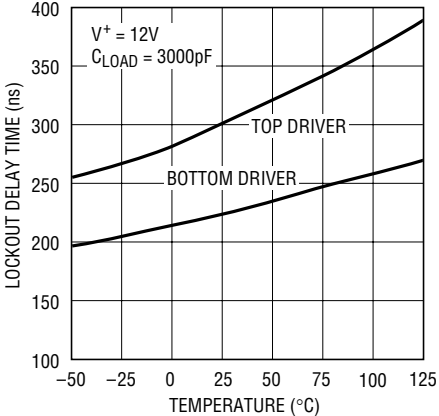

1160/62 G16

**Release Delay Time vs Temperature**

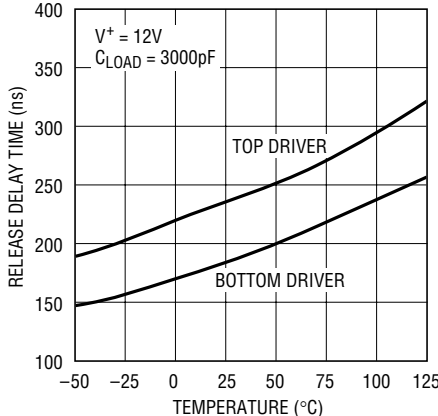

1160/62 G17

## PIN FUNCTIONS

### LT1160

**SV<sup>+</sup> (Pin 1):** Main Signal Supply. Must be closely decoupled to the signal ground Pin 5.

**IN TOP (Pin 2):** Top Driver Input. Pin 2 is disabled when Pin 3 is high. A 3k input resistor followed by a 5V internal clamp prevents saturation of the input transistors.

**IN BOTTOM (Pin 3):** Bottom Driver Input. Pin 3 is disabled when Pin 2 is high. A 3k input resistor followed by a 5V internal clamp prevents saturation of the input transistors.

**UV OUT (Pin 4):** Undervoltage Output. Open collector NPN output which turns on when V<sup>+</sup> drops below the undervoltage threshold.

**SGND (Pin 5):** Small Signal Ground. Must be routed separately from other grounds to the system ground.

**PGND (Pin 6):** Bottom Driver Power Ground. Connects to source of bottom N-channel MOSFET.

**B GATE FB (Pin 8):** Bottom Gate Feedback. Must connect directly to the bottom power MOSFET gate. The top MOSFET turn-on is inhibited until Pin 8 has discharged to below 2.5V.

**B GATE DR (Pin 9):** Bottom Gate Drive. The high current drive point for the bottom MOSFET. When a gate resistor is used it is inserted between Pin 9 and the gate of the MOSFET.

**PV<sup>+</sup> (Pin 10):** Bottom Driver Supply. Must be connected to the same supply as Pin 1.

**T SOURCE (Pin 11):** Top Driver Return. Connects to the top MOSFET source and the low side of the bootstrap capacitor.

**T GATE FB (Pin 12):** Top Gate Feedback. Must connect directly to the top power MOSFET gate. The bottom MOSFET turn-on is inhibited until V<sub>12</sub> - V<sub>11</sub> has discharged to below 2.9V.

**T GATE DR (Pin 13):** Top Gate Drive. The high current drive point for the top MOSFET. When a gate resistor is used it is inserted between Pin 13 and the gate of the MOSFET.

**BOOST (Pin 14):** Top Driver Supply. Connects to the high side of the bootstrap capacitor.

### LT1162

**SV<sup>+</sup> (Pins 1, 7):** Main Signal Supply. Must be closely decoupled to ground Pins 5 and 11.

**IN TOP (Pins 2, 8):** Top Driver Input. The Input Top is disabled when the Input Bottom is high. A 3k input resistor followed by a 5V internal clamp prevents saturation of the input transistors.

**IN BOTTOM (Pins 3, 9):** Bottom Driver Input. The Input Bottom is disabled when the Input Top is high. A 3k input resistor followed by a 5V internal clamp prevents saturation of the input transistors.

**UV OUT (Pins 4, 10):** Undervoltage Output. Open collector NPN output which turns on when V<sup>+</sup> drops below the undervoltage threshold.

**GND (Pins 5, 11):** Ground Connection.

**B GATE FB (Pins 6, 12):** Bottom Gate Feedback. Must connect directly to the bottom power MOSFET gate. The top MOSFET turn-on is inhibited until Bottom Gate Feedback pins have discharged to below 2.5V.

**B GATE DR (Pins 13, 19):** Bottom Gate Drive. The high current drive point for the bottom MOSFET. When a gate resistor is used it is inserted between the Bottom Gate Drive pin and the gate of the MOSFET.

**PV<sup>+</sup> (Pins 14, 20):** Bottom Driver Supply. Must be connected to the same supply as Pins 1 and 7.

**T SOURCE (Pins 15, 21):** Top Driver Return. Connects to the top MOSFET source and the low side of the bootstrap capacitor.

**T GATE FB (Pins 16, 22):** Top Gate Feedback. Must connect directly to the top power MOSFET gate. The bottom MOSFET turn-on is inhibited until V<sub>TGF</sub> - V<sub>TSOURCE</sub> has discharged to below 2.9V.

**T GATE DR (Pins 17, 23):** Top Gate Drive. The high current drive point for the top MOSFET. When a gate resistor is used it is inserted between the Top Gate Drive pin and the gate of the MOSFET.

**BOOST (Pins 18, 24):** Top Driver Supply. Connects to the high side of the bootstrap capacitor.

# FUNCTIONAL DIAGRAM (LT1160 or 1/2 LT1162)



# TEST CIRCUIT (LT1160 or 1/2 LT1162)



## TIMING DIAGRAM

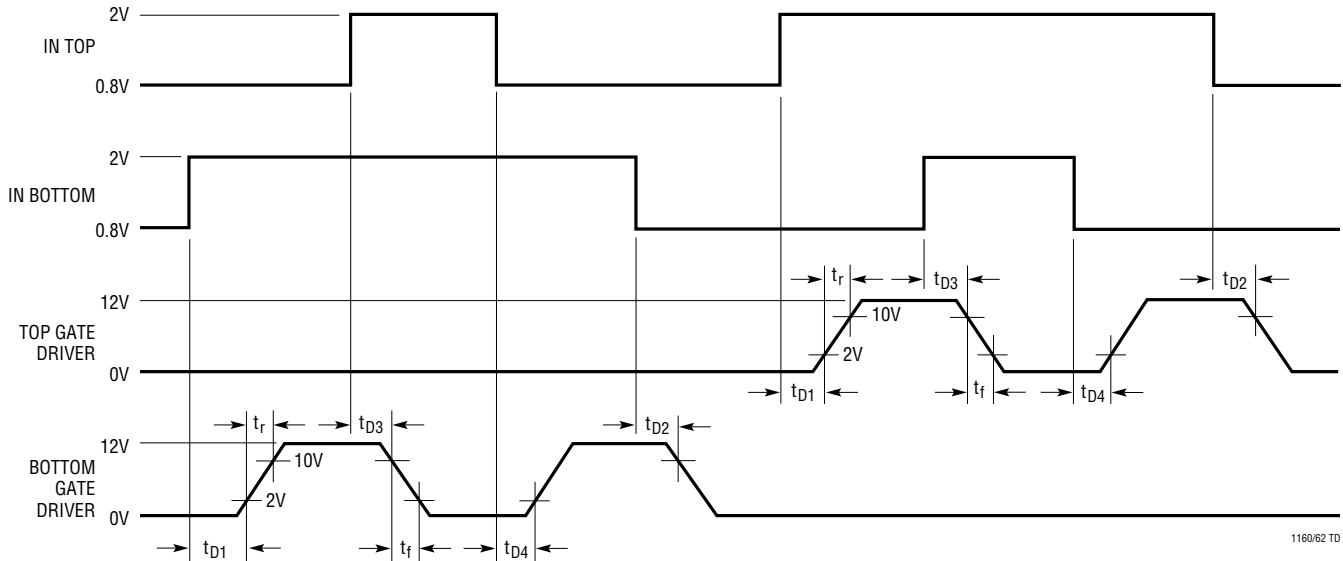

1160/62 TD

## OPERATION (Refer to Functional Diagram)

The LT1160 (or 1/2 LT1162) incorporates two independent driver channels with separate inputs and outputs. The inputs are TTL/CMOS compatible; they can withstand input voltages as high as  $V^+$ . The 1.4V input threshold is regulated and has 300mV of hysteresis. Both channels are noninverting drivers. The internal logic prevents both outputs from simultaneously turning on under any input conditions. When both inputs are high both outputs are actively held low.

The floating supply for the top driver is provided by a bootstrap capacitor between the Boost pin and the Top Source pin. This capacitor is recharged each time the negative plate goes low in PWM operation.

The undervoltage detection circuit disables both channels when  $V^+$  is below the undervoltage trip point. A separate

UV detect block disables the high side channel when  $V_{BOOST} - V_{TSOURCE}$  is below its own undervoltage trip point.

The top and bottom gate drivers in the LT1160 each utilize two gate connections: 1) a gate drive pin, which provides the turn on and turn off currents through an optional series gate resistor, and 2) a gate feedback pin which connects directly to the gate to monitor the gate-to-source voltage.

Whenever there is an input transition to command the outputs to change states, the LT1160 follows a logical sequence to turn off one MOSFET and turn on the other. First, turn-off is initiated, then  $V_{GS}$  is monitored until it has decreased below the turn-off threshold, and finally the other gate is turned on.



## APPLICATIONS INFORMATION

### Power MOSFET Selection

Since the LT1160 (or 1/2 LT1162) inherently protects the top and bottom MOSFETs from simultaneous conduction, there are no size or matching constraints. Therefore selection can be made based on the operating voltage and  $R_{DS(ON)}$  requirements. The MOSFET  $BV_{DSS}$  should be greater than the HV and should be increased to approximately (2)(HV) in harsh environments with frequent fault conditions. For the LT1160 maximum operating HV supply of 60V, the MOSFET  $BV_{DSS}$  should be from 60V to 100V.

The MOSFET  $R_{DS(ON)}$  is specified at  $T_J = 25^\circ\text{C}$  and is generally chosen based on the operating efficiency required as long as the maximum MOSFET junction temperature is not exceeded. The dissipation while each MOSFET is on is given by:

$$P = D(I_{DS})^2(1+\partial)R_{DS(ON)}$$

Where D is the duty cycle and  $\partial$  is the increase in  $R_{DS(ON)}$  at the anticipated MOSFET junction temperature. From this equation the required  $R_{DS(ON)}$  can be derived:

$$R_{DS(ON)} = \frac{P}{D(I_{DS})^2(1+\partial)}$$

For example, if the MOSFET loss is to be limited to 2W when operating at 5A and a 90% duty cycle, the required  $R_{DS(ON)}$  would be  $0.089\Omega/(1+\partial)$ .  $(1+\partial)$  is given for each MOSFET in the form of a normalized  $R_{DS(ON)}$  vs temperature curve, but  $\partial = 0.007/^\circ\text{C}$  can be used as an approximation for low voltage MOSFETs. Thus, if  $T_A = 85^\circ\text{C}$  and the available heat sinking has a thermal resistance of  $20^\circ\text{C}/\text{W}$ , the MOSFET junction temperature will be  $125^\circ\text{C}$  and  $\partial = 0.007(125 - 25) = 0.7$ . This means that the required  $R_{DS(ON)}$  of the MOSFET will be  $0.089\Omega/1.7 = 0.0523\Omega$ , which can be satisfied by an IRFZ34 manufactured by International Rectifier.

Transition losses result from the power dissipated in each MOSFET during the time it is transitioning from off to on, or from on to off. These losses are proportional to  $(f)(\text{HV})^2$  and vary from insignificant to being a limiting factor on operating frequency in some high voltage applications.

### Paralleling MOSFETs

When the above calculations result in a lower  $R_{DS(ON)}$  than is economically feasible with a single MOSFET, two or more MOSFETs can be paralleled. The MOSFETs will inherently share the currents according to their  $R_{DS(ON)}$  ratio as long as they are thermally connected (e.g., on a common heat sink). The LT1160 top and bottom drivers can each drive five power MOSFETs in parallel with only a small loss in switching speeds (see Typical Performance Characteristics). A low value resistor ( $10\Omega$  to  $47\Omega$ ) in series with each individual MOSFET gate may be required to “decouple” each MOSFET from its neighbors to prevent high frequency oscillations (consult manufacturer’s recommendations). If gate decoupling resistors are used the corresponding gate feedback pin can be connected to any one of the gates as shown in Figure 1.

Driving multiple MOSFETs in parallel may restrict the operating frequency to prevent overdissipation in the LT1160 (see the following Gate Charge and Driver Dissipation).

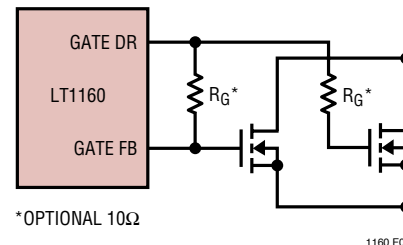

Figure 1. Paralleling MOSFETs

### Gate Charge and Driver Dissipation

A useful indicator of the load presented to the driver by a power MOSFET is the total gate charge  $Q_G$ , which includes the additional charge required by the gate-to-drain swing.  $Q_G$  is usually specified for  $V_{GS} = 10\text{V}$  and  $V_{DS} = 0.8V_{DS(MAX)}$ . When the supply current is measured in a switching application, it will be larger than given by the DC electrical characteristics because of the additional supply current associated with sourcing the MOSFET gate charge:

$$I_{SUPPLY} = I_{DC} + \left(\frac{dQ_G}{dt}\right)_{TOP} + \left(\frac{dQ_G}{dt}\right)_{BOTTOM}$$

## APPLICATIONS INFORMATION

The actual increase in supply current is slightly higher due to LT1160 switching losses and the fact that the gates are being charged to more than 10V. Supply Current vs Input Frequency is given in the Typical Performance Characteristics.

The LT1160 junction temperature can be estimated by using the equations given in Note 2 of the Electrical Characteristics. For example, the LT1160IS is limited to less than 31mA from a 12V supply:

$$T_J = 85^\circ\text{C} + (31\text{mA})(12\text{V})(110^\circ\text{C/W}) \\ = 126^\circ\text{C} \text{ exceeds absolute maximum}$$

In order to prevent the maximum junction temperature from being exceeded, the LT1160 supply current must be verified while driving the full complement of the chosen MOSFET type at the maximum switching frequency.

### Ugly Transient Issues

In PWM applications the drain current of the top MOSFET is a square wave at the input frequency and duty cycle. To prevent large voltage transients at the top drain, a low ESR electrolytic capacitor must be used and returned to the power ground. The capacitor is generally in the range of 25 $\mu\text{F}$  to 5000 $\mu\text{F}$  and must be physically sized for the RMS current flowing in the drain to prevent heating and premature failure. In addition, the LT1160 requires a separate 10 $\mu\text{F}$  capacitor connected closely between Pins 1 and 5 (the LT1162 requires two 10 $\mu\text{F}$  capacitors connected between Pins 1 and 5, and Pins 7 and 11).

The LT1160 top source is internally protected against transients below ground and above supply. However, the gate drive pins cannot be forced below ground. In most applications, negative transients coupled from the source to the gate of the top MOSFET do not cause any problems.

### Switching Regulator Applications

The LT1160 (or 1/2 LT1162) is ideal as a synchronous switch driver to improve the efficiency of step-down (buck) switching regulators. Most step-down regulators use a high current Schottky diode to conduct the inductor current when the switch is off. The fractions of the oscil-

lator period that the switch is on (switch conducting) and off (diode conducting) are given by:

$$\text{Switch ON} = \left( \frac{V_{\text{OUT}}}{\text{HV}} \right) (\text{Total Period}) \\ \text{Switch OFF} = \left( \frac{\text{HV} - V_{\text{OUT}}}{\text{HV}} \right) (\text{Total Period})$$

Note that for  $\text{HV} > 2V_{\text{OUT}}$  the switch is off longer than it is on, making the diode losses more significant than the switch. The worst case for the diode is during a short circuit, when  $V_{\text{OUT}}$  approaches zero and the diode conducts the short-circuit current almost continuously.

Figure 2 shows the LT1160 used to synchronously drive a pair of power MOSFETs in a step-down regulator application, where the top MOSFET is the switch and the bottom MOSFET replaces the Schottky diode. Since both conduction paths have low losses, this approach can result in very high efficiency (90% to 95%) in most applications. For regulators under 10A, using low  $R_{\text{DS(ON)}}$  N-channel MOSFETs eliminates the need for heat sinks.  $R_{\text{GS}}$  holds the top MOSFET off when HV is applied before the 12V supply.

One fundamental difference in the operation of a step-down regulator with synchronous switching is that it never becomes discontinuous at light loads. The inductor current doesn't stop ramping down when it reaches zero but actually reverses polarity resulting in a constant ripple current independent of load. This does not cause a significant efficiency loss (as might be expected) since the negative inductor current is returned to HV when the switch turns back on. However,  $i^2R$  losses will occur under these conditions due to the recirculating currents.

The LT1160 performs the synchronous MOSFET drive in a step-down switching regulator. A reference and PWM are required to complete the regulator. Any voltage mode or current mode PWM controller may be used but the LT3526 is particularly well-suited to high power, high efficiency applications such as the 10A circuit shown in Figure 4. In higher current regulators a small Schottky diode across the bottom MOSFET helps to reduce reverse-recovery switching losses.

## APPLICATIONS INFORMATION

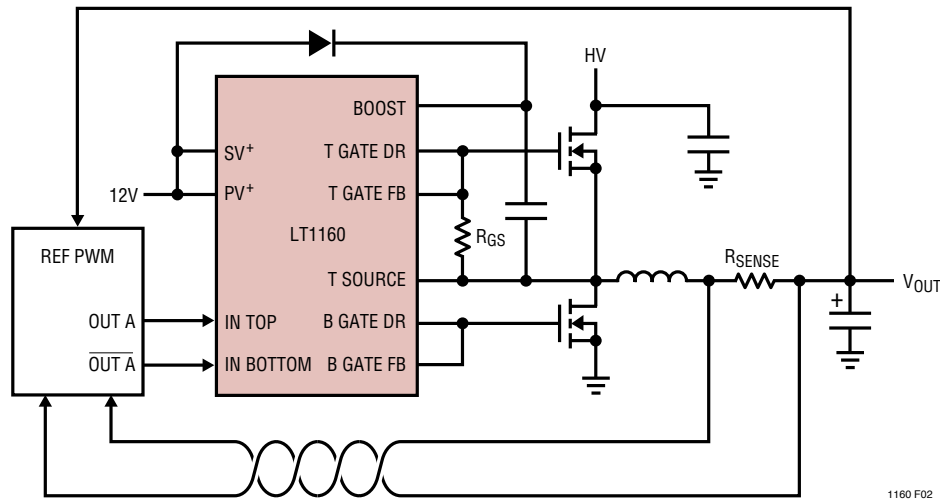

Figure 2. Adding Synchronous Switching to a Step-Down Switching Regulator

### Motor Drive Applications

In applications where rotation is always in the same direction, a single LT1160 controlling a half-bridge can be used to drive a DC motor. One end of the motor may be connected either to supply or to ground as seen on Figure 3. A motor in this configuration is controlled by its inputs which give three alternatives: run, free running stop (coasting) and fast stop (“plugging” braking, with the motor shorted by one of the MOSFETs).

To drive a DC motor in both directions the LT1162 can be used to drive an H-bridge output stage. In this configuration the motor can be made to run clockwise, counter-clockwise, stop rapidly (“plugging” braking) or free run (coast) to a stop. A very rapid stop may be achieved by reversing the current, though this requires more careful design to stop the motor dead. In practice a closed-loop control system with tachometric feedback is usually necessary.

The motor speed in these examples can be controlled by switching the drivers with pulse width modulated square waves. This approach is particularly suitable for micro-computers/DSP control loops.

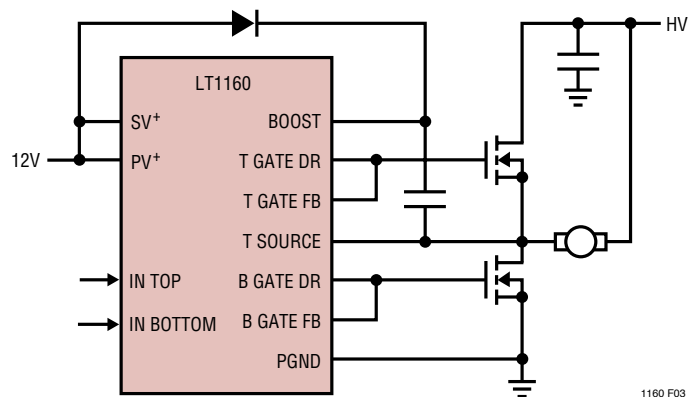

Figure 3. Driving a Supply Referenced Motor

TYPICAL APPLICATIONS



Figure 4. 90% Efficiency, 40V to 5V 10A Low Dropout Voltage Mode Switching Regulator



Figure 5. 90% Efficiency, 40V to 5V 10A Low Dropout Current Mode Switching Regulator

# TYPICAL APPLICATIONS

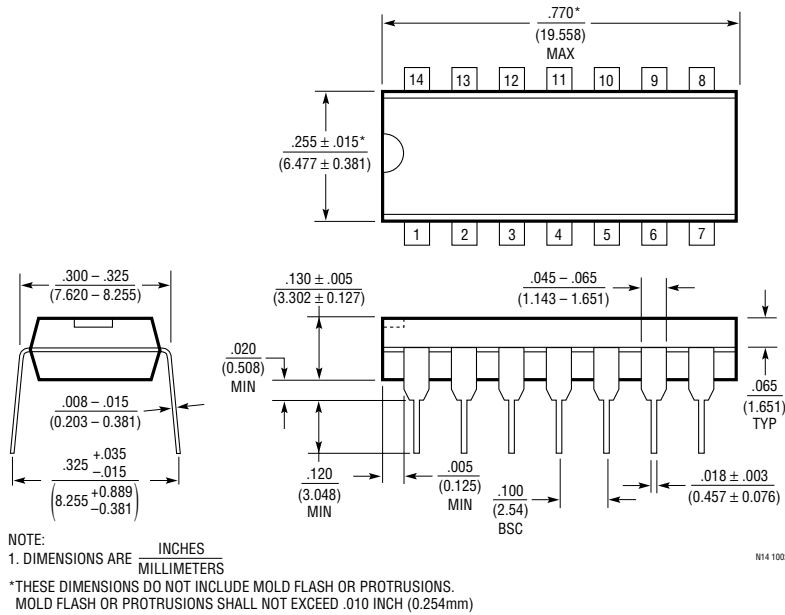

Figure 6. 200W Class D, 10Hz to 1kHz Amplifier

Kool Mµ is a registered trademark of Magnetics, Inc.

**PACKAGE DESCRIPTION**

**N Package**  
**14-Lead PDIP (Narrow .300 Inch)**  
 (Reference LTC DWG # 05-08-1510)



**N Package**  
**24-Lead PDIP (Narrow .300 Inch)**  
 (Reference LTC DWG # 05-08-1510)

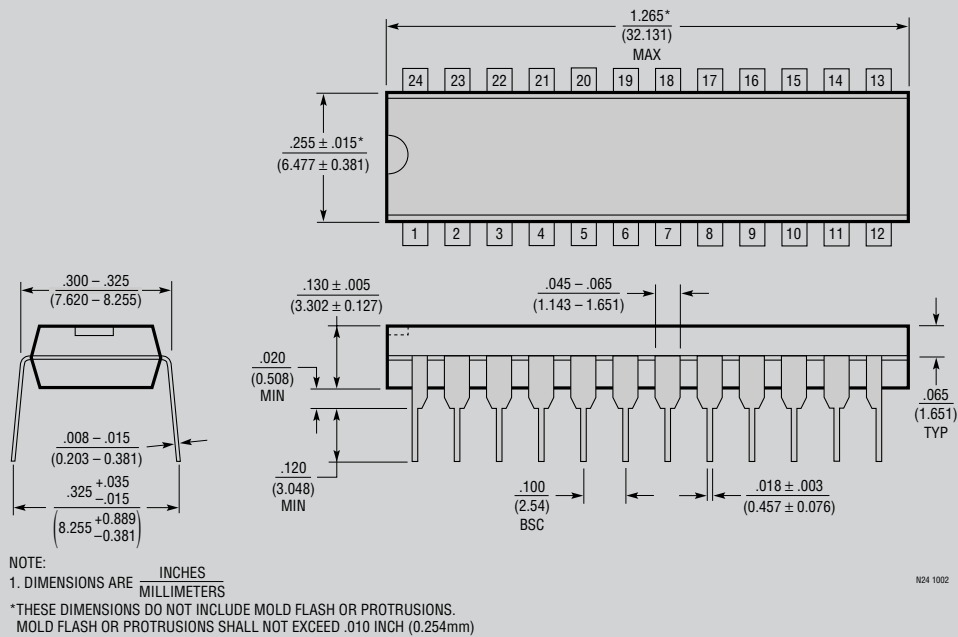

**OBSOLETE PACKAGE**

**PACKAGE DESCRIPTION**

**S Package**  
**14-Lead Plastic Small Outline (Narrow .150 Inch)**  
 (Reference LTC DWG # 05-08-1610)

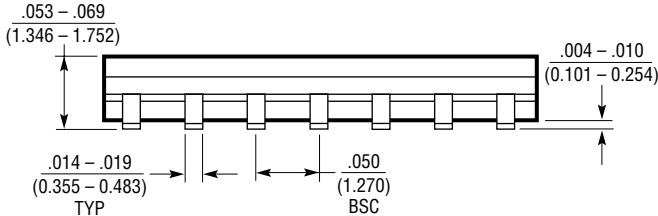
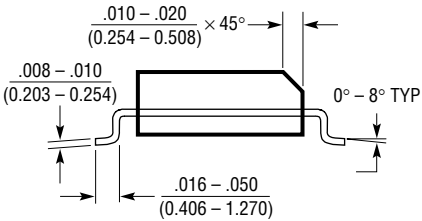
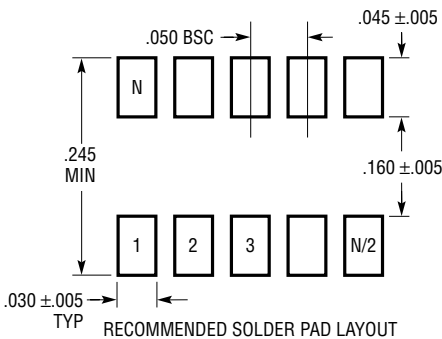

- NOTE:  
 1. DIMENSIONS IN  $\frac{\text{INCHES}}{\text{MILLIMETERS}}$   
 2. DRAWING NOT TO SCALE  
 3. THESE DIMENSIONS DO NOT INCLUDE MOLD FLASH OR PROTRUSIONS.  
 MOLD FLASH OR PROTRUSIONS SHALL NOT EXCEED .006" (0.15mm)

S14 0502

**PACKAGE DESCRIPTION**

**SW Package**  
**24-Lead Plastic Small Outline (Wide .300 Inch)**  
 (Reference LTC DWG # 05-08-1620)

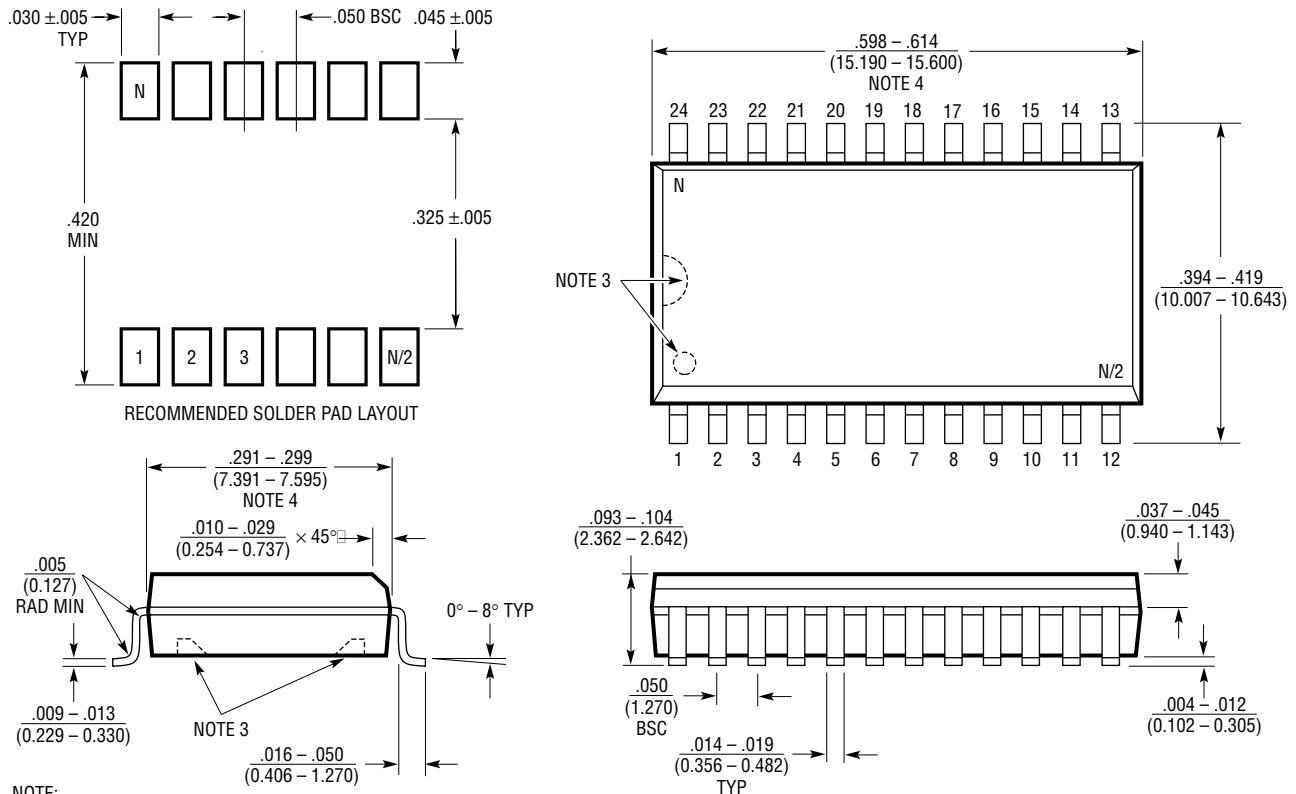

- NOTE:
1. DIMENSIONS IN  $\frac{\text{INCHES}}{\text{MILLIMETERS}}$
  2. DRAWING NOT TO SCALE
  3. PIN 1 IDENT, NOTCH ON TOP AND CAVITIES ON THE BOTTOM OF PACKAGES ARE THE MANUFACTURING OPTIONS. THE PART MAY BE SUPPLIED WITH OR WITHOUT ANY OF THE OPTIONS
  4. THESE DIMENSIONS DO NOT INCLUDE MOLD FLASH OR PROTRUSIONS. MOLD FLASH OR PROTRUSIONS SHALL NOT EXCEED  $.006"$  ( $0.15\text{mm}$ )

S24 (WIDE) 0502

**RELATED PARTS**

PART NUMBER	DESCRIPTION	COMMENTS
LT1158	Half-Bridge N-Channel Power MOSFET Driver	Single Input, Continuous Current Protection and Internal Charge Pump for DC Operation
LT1336	Half-Bridge N-Channel Power MOSFET Driver with Boost Regulator	Onboard Boost Regulator to Supply the High Side Driver
LT1910	Protected High Side MOSFET Driver	$V_{IN} = 8\text{V}$ to $48\text{V}$ , Protected from $-15\text{V}$ to $60\text{V}$ Transients, Auto Restart, Fault Indication
LTC1922-1	Synchronous Phase Modulated Full-Bridge Controller	Output Power from $50\text{W}$ to Kilowatts, Adaptive Direct Sense Zero Voltage Switching Compensates for External Component Tolerances
LTC1923	Full-Bridge Controller for Thermoelectric Coolers	High Efficiency, Adjustable Slew Rate Reduces EMI 5mm x 5mm QFN and 28-Pin SSOP



Компания «Океан Электроники» предлагает заключение долгосрочных отношений при поставках импортных электронных компонентов на взаимовыгодных условиях!

Наши преимущества:

- Поставка оригинальных импортных электронных компонентов напрямую с производств Америки, Европы и Азии, а так же с крупнейших складов мира;
- Широкая линейка поставок активных и пассивных импортных электронных компонентов (более 30 млн. наименований);
- Поставка сложных, дефицитных, либо снятых с производства позиций;
- Оперативные сроки поставки под заказ (от 5 рабочих дней);
- Экспресс доставка в любую точку России;
- Помощь Конструкторского Отдела и консультации квалифицированных инженеров;
- Техническая поддержка проекта, помощь в подборе аналогов, поставка прототипов;
- Поставка электронных компонентов под контролем ВП;
- Система менеджмента качества сертифицирована по Международному стандарту ISO 9001;
- При необходимости вся продукция военного и аэрокосмического назначения проходит испытания и сертификацию в лаборатории (по согласованию с заказчиком);
- Поставка специализированных компонентов военного и аэрокосмического уровня качества (Xilinx, Altera, Analog Devices, Intersil, Interpoint, Microsemi, Actel, Aeroflex, Peregrine, VPT, Syfer, Eurofarad, Texas Instruments, MS Kennedy, Miteq, Cobham, E2V, MA-COM, Hittite, Mini-Circuits, General Dynamics и др.);

Компания «Океан Электроники» является официальным дистрибьютором и эксклюзивным представителем в России одного из крупнейших производителей разъемов военного и аэрокосмического назначения «JONHON», а так же официальным дистрибьютором и эксклюзивным представителем в России производителя высокотехнологичных и надежных решений для передачи СВЧ сигналов «FORSTAR».



## JONHON

«JONHON» (основан в 1970 г.)

Разъемы специального, военного и аэрокосмического назначения:

(Применяются в военной, авиационной, аэрокосмической, морской, железнодорожной, горно- и нефтедобывающей отраслях промышленности)

«FORSTAR» (основан в 1998 г.)

ВЧ соединители, коаксиальные кабели, кабельные сборки и микроволновые компоненты:

(Применяются в телекоммуникациях гражданского и специального назначения, в средствах связи, РЛС, а так же военной, авиационной и аэрокосмической отраслях промышленности).



Телефон: 8 (812) 309-75-97 (многоканальный)

Факс: 8 (812) 320-03-32

Электронная почта: [ocean@oceanchips.ru](mailto:ocean@oceanchips.ru)

Web: <http://oceanchips.ru/>

Адрес: 198099, г. Санкт-Петербург, ул. Калинина, д. 2, корп. 4, лит. А