



## 14 Gbps, FAST RISE TIME XOR / XNOR GATE w/ PROGRAMMABLE OUTPUT VOLTAGE

### Typical Applications

The HMC721LP3E is ideal for:

- 16 G Fiber Channel
- RF ATE Applications
- Broadband Test & Measurement
- Serial Data Transmission up to 14 Gbps
- Digital Logic Systems up to 14 GHz

### Features

- Inputs Terminated Internally in 50 Ohms
- Differential or Single-Ended Operation
- Fast Rise and Fall Times: 19 / 18 ps
- Low Power Consumption: 230 mW typ.
- Programmable Differential Output Voltage Swing: 600 - 1200 mVp-p
- Propagation Delay: 95 ps
- Single Supply: -3.3 V
- 16 Lead 3x3 mm SMT Package: 9 mm<sup>2</sup>

### Functional Diagram

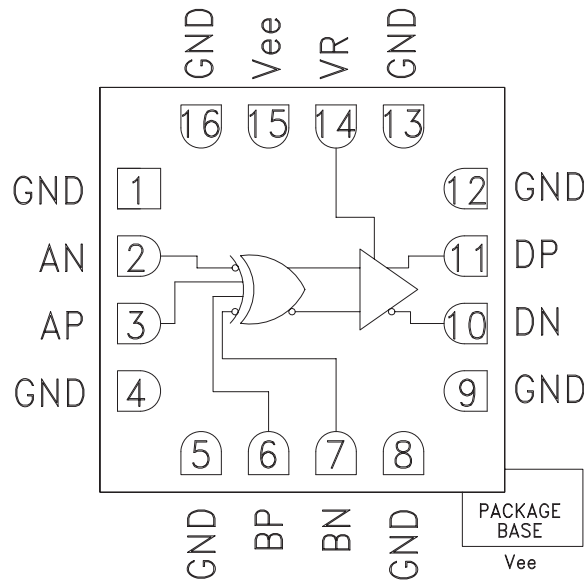

### General Description

The HMC721LP3E is a XOR/XNOR gate function designed to support data transmission rates of up to 14 Gbps, and clock frequencies as high as 14 GHz.

All differential inputs to the HMC721LP3E are CML and terminated on-chip with 50 Ohms to the positive supply, GND, and may be DC or AC coupled. Outputs can be connected directly to a 50 Ohm ground-terminated system or drive devices with CML logic input. The HMC721LP3E also features an output level control pin, VR, which allows for loss compensation or signal level optimization. The HMC721LP3E operates from a single -3.3 V supply and is available in ROHS-compliant 3x3 mm SMT package..

### Electrical Specifications, $T_A = +25\text{ }^\circ\text{C}$ , $V_{ee} = -3.3\text{ V}$ , $VR = 0\text{ V}$

Parameter	Conditions	Min.	Typ.	Max	Units
Power Supply Voltage		-3.6	-3.3	-3.0	V
Power Supply Current			70		mA
Maximum Data Rate			14		Gbps
Maximum Clock Rate			14		GHz
Input Voltage Range		-1.5		0.5	V
Input Differential Range		0.1		2.0	Vp-p
Input Return Loss	Frequency <14 GHz		10		dB
Output Amplitude	Single-Ended, peak-to-peak		550		mVp-p
	Differential, peak-to-peak		1100		mVp-p
Output High Voltage			-10		mV
Output Low Voltage			-560		mV
Output Rise / Fall Time	Differential, 20% - 80%		19 / 18		ps

For price, delivery and to place orders: Hittite Microwave Corporation, 20 Alpha Road, Chelmsford, MA 01824

Phone: 978-250-3343 Fax: 978-250-3373 Order On-line at [www.hittite.com](http://www.hittite.com)

Application Support: Phone: 978-250-3343 or [apps@hittite.com](mailto:apps@hittite.com)



**14 Gbps, FAST RISE TIME XOR / XNOR GATE  
w/ PROGRAMMABLE OUTPUT VOLTAGE**

**Electrical Specifications (continued)**

Parameter	Conditions	Min.	Typ.	Max	Units
Output Return Loss	Frequency <13 GHz		10		dB
Small Signal Gain			27		dB
Random Jitter Jr	rms			0.2	ps rms
Deterministic Jitter, Jd	peak-to-peak, 2 <sup>15</sup> -1 PRBS input [1]		2		ps, pp
Propagation Delay, td			95		ps
VR Pin Current	VR = 0.0 V		2		mA
VR Pin Current	VR = +0.4 V			3.5	mA

[1] Deterministic jitter calculated by simultaneously measuring the jitter of a 300 mV, 13 GHz, 2<sup>15</sup>-1 PRBS input, and a single-ended output

**DC Current vs. Supply Voltage [1][2]**

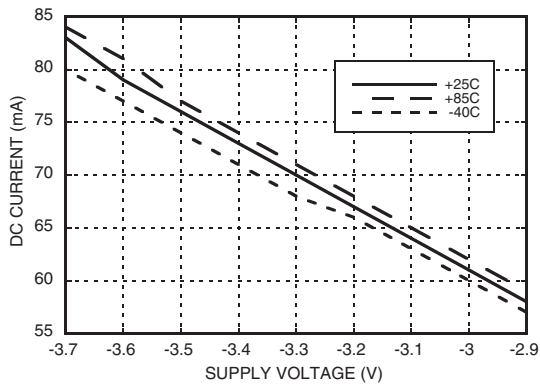

**Output Differential Voltage vs. Supply Voltage [1][3]**

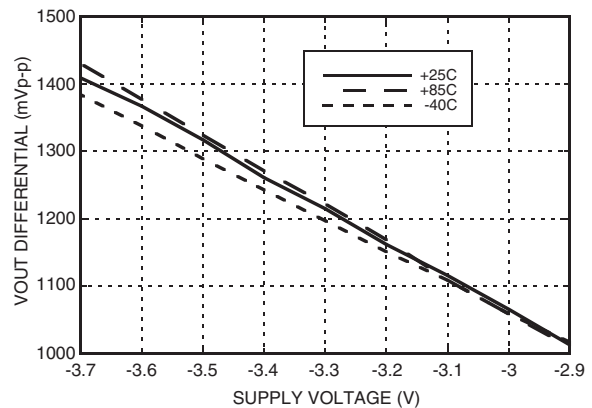

**Rise / Fall Time vs. VR [2][4]**

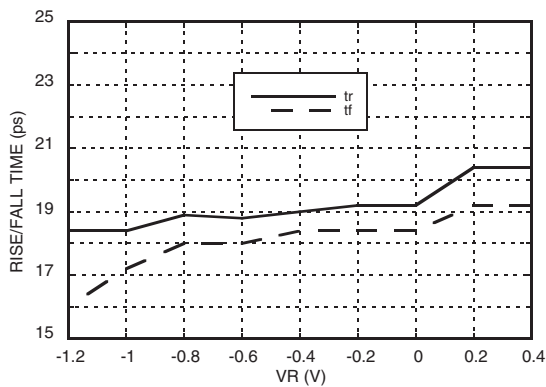

**Output Differential Voltage vs. VR [3][4]**

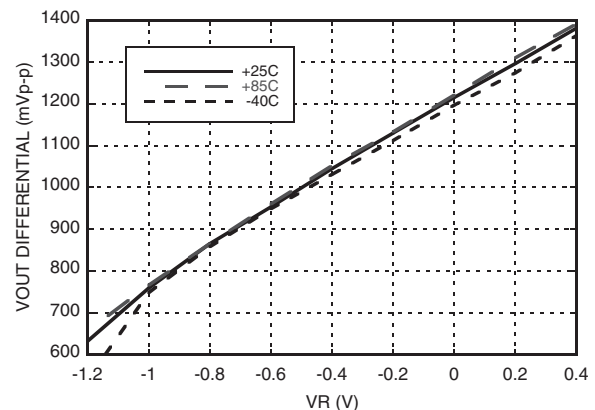

[1] VR = 0.0 V

[2] Frequency = 13 GHz

[3] Frequency = 10 GHz

[4] Vee = -3.3 V



**14 Gbps, FAST RISE TIME XOR / XNOR GATE  
w/ PROGRAMMABLE OUTPUT VOLTAGE**

3

HIGH SPEED LOGIC - SMT

**Rise / Fall Time vs. Supply Voltage [1][2]**

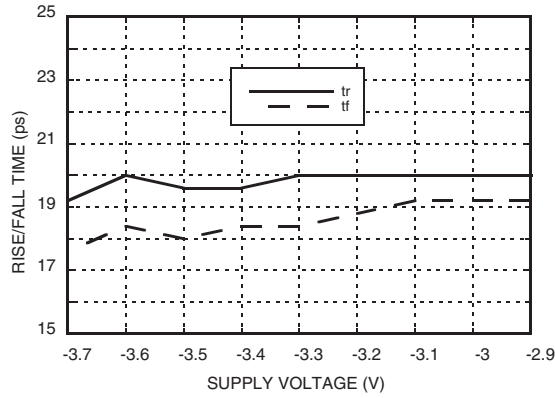

**Output Differential Voltage vs. Frequency [1][3]**

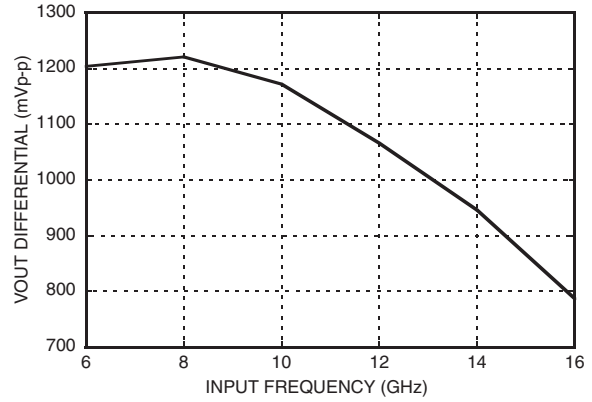

**Input Return Loss vs. Frequency**

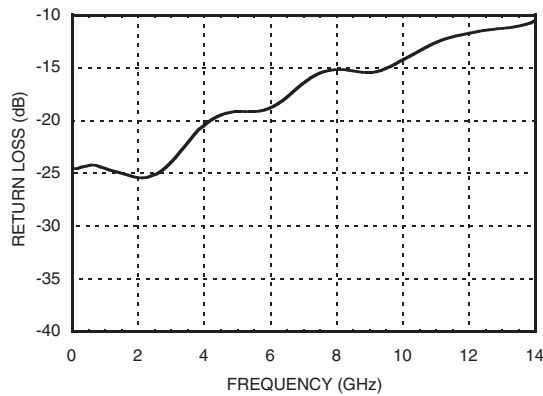

**Output Return Loss vs. Frequency**

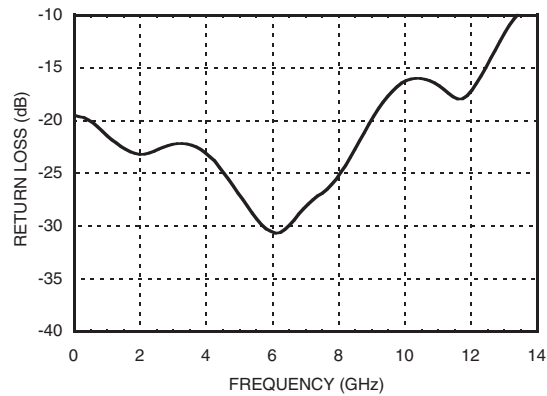

[1] VR = 0.0 V

[2] Frequency = 13 GHz

[3] Vee = -3.3 V



## 14 Gbps, FAST RISE TIME XOR / XNOR GATE w/ PROGRAMMABLE OUTPUT VOLTAGE

### Eye Diagram

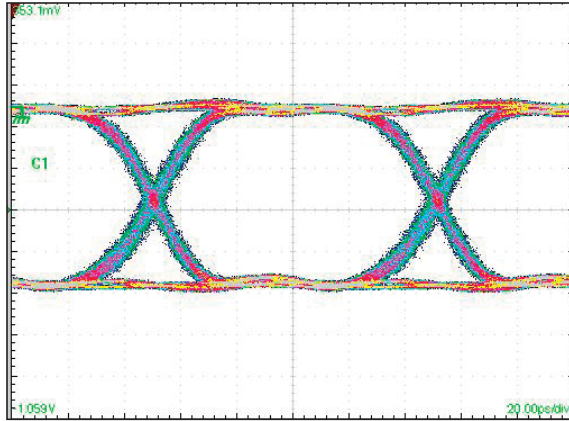

[1] Test Conditions:  
Waveform generated with an Agilent N4903A J-Bert. Rate = 10 Gbps.  
Eye diagram data presented on a Tektronix CSA 8000

### Timing Diagram

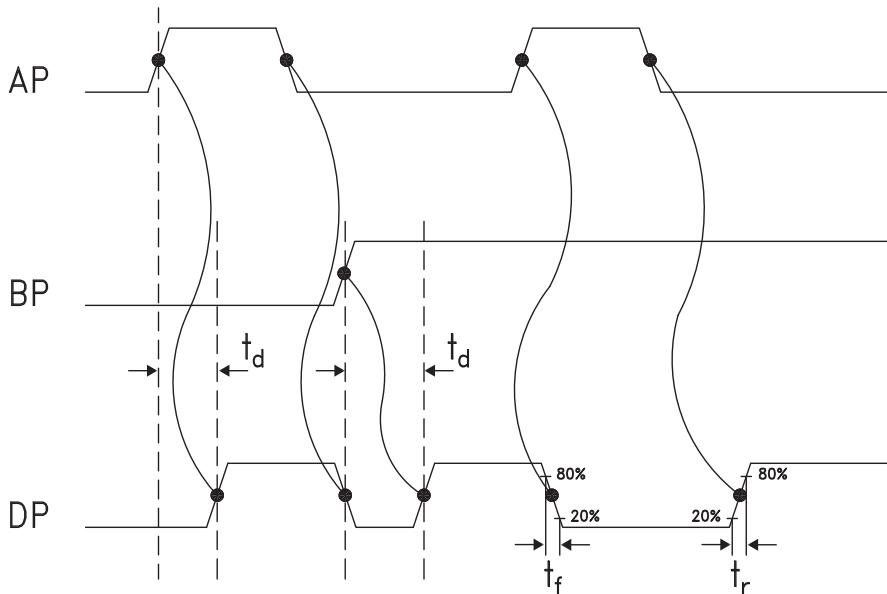

### Truth Table

Input		Outputs
A	B	D
L	L	L
L	H	H
H	L	H
H	H	L

Notes:  
A = AP - AN  
B = BP - BN  
D = DP - DN

H - Positive voltage level  
L - Negative voltage level



## 14 Gbps, FAST RISE TIME XOR / XNOR GATE w/ PROGRAMMABLE OUTPUT VOLTAGE

### Absolute Maximum Ratings

Power Supply Voltage (Vee)	-3.75 V to +0.5 V
Input Signals	-2 V to +0.5 V
Output Signals	-1.5 V to +1 V
Junction Temperature	125 °C
Continuous Pdiss (T = 85 °C) (derate 20.4 mW/°C above 85 °C)	0.816 W
Thermal Resistance (Rthj-p) Worst case junction to package paddle	49 °C/W
Storage Temperature	-65 °C to +150 °C
Operating Temperature	-40 °C to +85 °C
ESD Sensitivity (HBM)	Class 1A



ELECTROSTATIC SENSITIVE DEVICE  
OBSERVE HANDLING PRECAUTIONS

### Outline Drawing

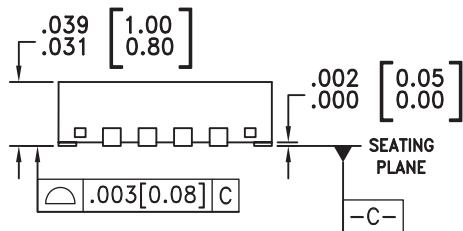
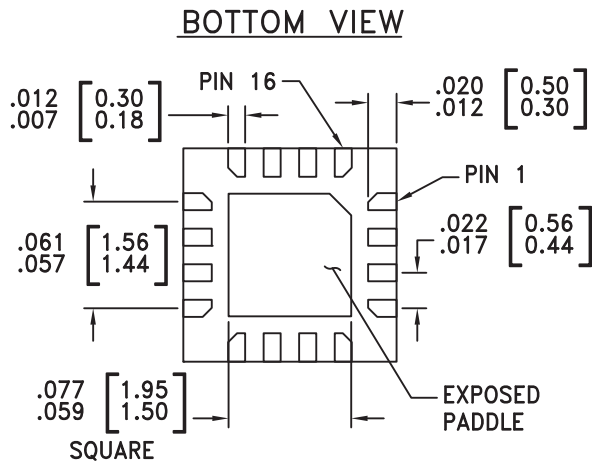
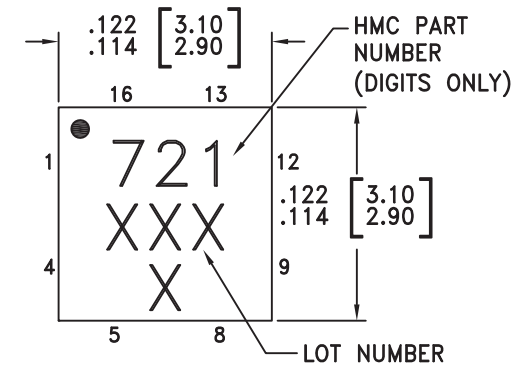

NOTES:

- LEADFRAME MATERIAL: COPPER ALLOY
- DIMENSIONS ARE IN INCHES [MILLIMETERS]
- LEAD SPACING TOLERANCE IS NON-CUMULATIVE
- PAD BURR LENGTH SHALL BE 0.15mm MAXIMUM.  
PAD BURR HEIGHT SHALL BE 0.05mm MAXIMUM.
- PACKAGE WARP SHALL NOT EXCEED 0.05mm.
- ALL GROUND LEADS MUST BE SOLDERED TO PCB RF GROUND.
- REFER TO HITTITE APPLICATION NOTE FOR SUGGESTED LAND PATTERN.
- PADDLE MUST BE SOLDERED TO Vee.

### Package Information



Part Number	Package Body Material	Lead Finish	MSL Rating	Package Marking <sup>[3]</sup>
HMC721LP3E	RoHS-compliant Low Stress Injection Molded Plastic	100% matte Sn	MSL1 <sup>[2]</sup>	721 XXXX

[1] Max peak reflow temperature of 235 °C  
 [2] Max peak reflow temperature of 260 °C  
 [3] 4-Digit lot number XXXX

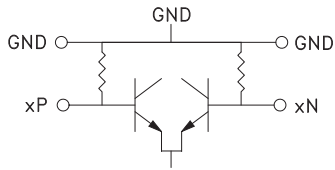
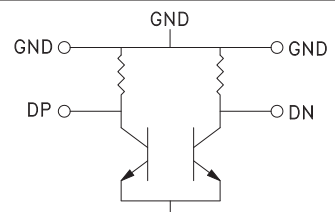

## 14 Gbps, FAST RISE TIME XOR / XNOR GATE w/ PROGRAMMABLE OUTPUT VOLTAGE

### Pin Descriptions

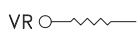
Pin Number	Function	Description	Interface Schematic
1, 4, 5, 8, 9, 12	GND	Signal Grounds	
2, 3 6, 7	AN, AP BP, BN	Differential Clock / Data Inputs: Current Mode Logic (CML) referenced to positive supply	
10, 11	DN, DP	Differential Clock / Data Outputs: Current Mode Logic (CML) referenced to positive supply	
13, 16	GND	Supply Ground	
14	VR	Output level control. Output level may be adjusted by either applying a voltage to VR per "Output Differential vs. VR" plot.	
15, Package Base	Vee	Negative Supply	

## 14 Gbps, FAST RISE TIME XOR / XNOR GATE w/ PROGRAMMABLE OUTPUT VOLTAGE

### Evaluation PCB

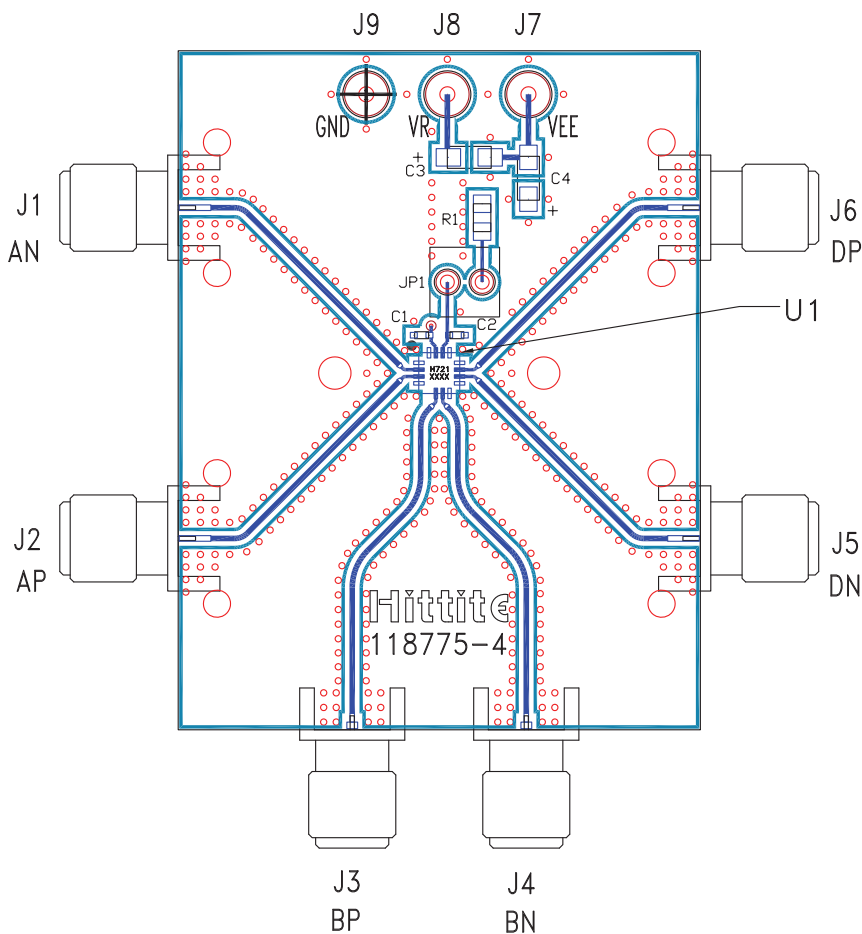

### List of Materials for Evaluation PCB 118777 [1]

Item	Description
J1 - J6	PCB Mount SMA RF Connectors
J7 - J9	DC Pin
JP1	0.1" Header with Shorting Jumper
C1, C2	100 pF Capacitor, 0402 Pkg.
C3, C4	4.7 μF Capacitor, Tantalum
R1	10 Ohm Resistor, 0603 Pkg.
U1	HMC721LP3E High Speed Logic, XOR / XNOR
PCB [2]	118775 Evaluation Board

[1] Reference this number when ordering complete evaluation PCB

[2] Circuit Board Material: Arlon 25FR or Rogers 4350

The circuit board used in the application should use RF circuit design techniques. Signal lines should have 50 Ohm impedance while the package ground leads should be connected directly to the ground plane similar to that shown. The exposed package base should be connected to Vee. A sufficient number of via holes should be used to connect the top and bottom ground planes. The evaluation circuit board shown is available from Hittite upon request. Install jumper on JP1 to short VR to GND for normal operation.

## 14 Gbps, FAST RISE TIME XOR / XNOR GATE w/ PROGRAMMABLE OUTPUT VOLTAGE

### Application Circuit

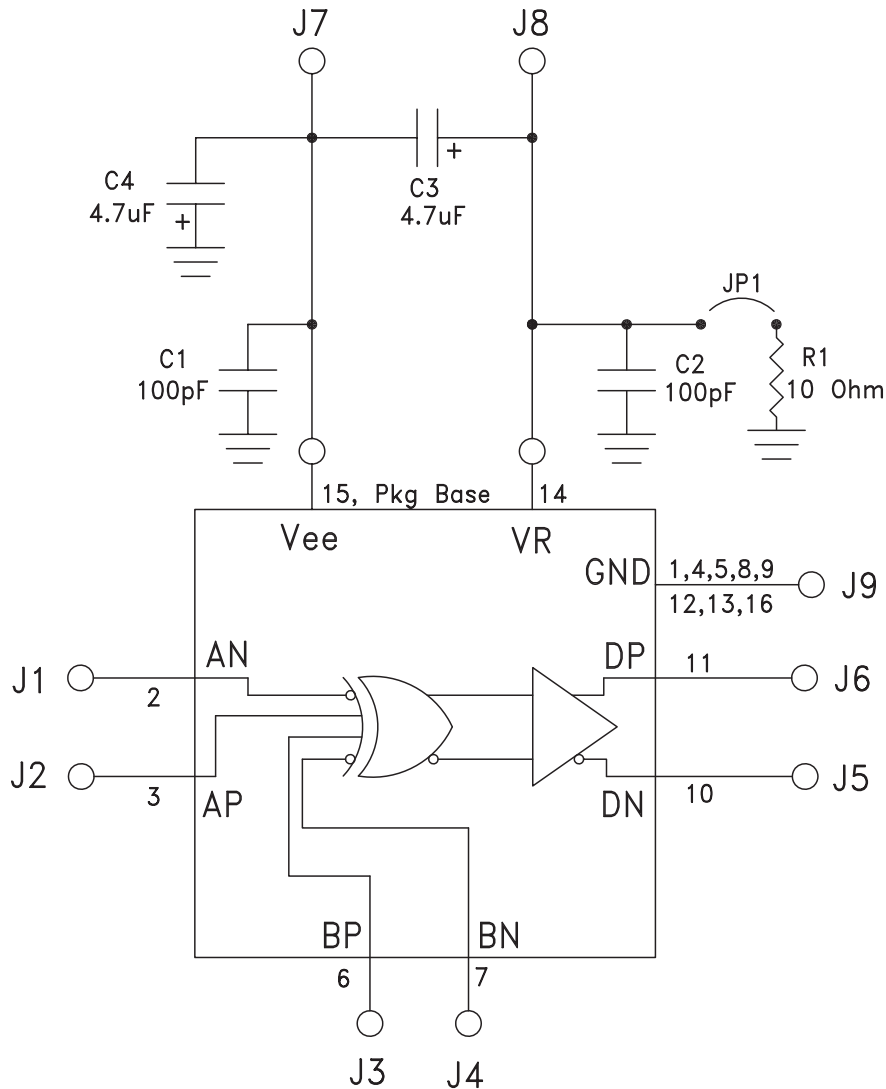



Компания «Океан Электроники» предлагает заключение долгосрочных отношений при поставках импортных электронных компонентов на взаимовыгодных условиях!

Наши преимущества:

- Поставка оригинальных импортных электронных компонентов напрямую с производств Америки, Европы и Азии, а так же с крупнейших складов мира;
- Широкая линейка поставок активных и пассивных импортных электронных компонентов (более 30 млн. наименований);
- Поставка сложных, дефицитных, либо снятых с производства позиций;
- Оперативные сроки поставки под заказ (от 5 рабочих дней);
- Экспресс доставка в любую точку России;
- Помощь Конструкторского Отдела и консультации квалифицированных инженеров;
- Техническая поддержка проекта, помощь в подборе аналогов, поставка прототипов;
- Поставка электронных компонентов под контролем ВП;
- Система менеджмента качества сертифицирована по Международному стандарту ISO 9001;
- При необходимости вся продукция военного и аэрокосмического назначения проходит испытания и сертификацию в лаборатории (по согласованию с заказчиком);
- Поставка специализированных компонентов военного и аэрокосмического уровня качества (Xilinx, Altera, Analog Devices, Intersil, Interpoint, Microsemi, Actel, Aeroflex, Peregrine, VPT, Syfer, Eurofarad, Texas Instruments, MS Kennedy, Miteq, Cobham, E2V, MA-COM, Hittite, Mini-Circuits, General Dynamics и др.);

Компания «Океан Электроники» является официальным дистрибьютором и эксклюзивным представителем в России одного из крупнейших производителей разъемов военного и аэрокосмического назначения «JONHON», а так же официальным дистрибьютором и эксклюзивным представителем в России производителя высокотехнологичных и надежных решений для передачи СВЧ сигналов «FORSTAR».



## JONHON

«JONHON» (основан в 1970 г.)

Разъемы специального, военного и аэрокосмического назначения:

(Применяются в военной, авиационной, аэрокосмической, морской, железнодорожной, горно- и нефтедобывающей отраслях промышленности)

«FORSTAR» (основан в 1998 г.)

ВЧ соединители, коаксиальные кабели,  
кабельные сборки и микроволновые компоненты:

(Применяются в телекоммуникациях гражданского и специального назначения, в средствах связи, РЛС, а так же военной, авиационной и аэрокосмической отраслях промышленности).



Телефон: 8 (812) 309-75-97 (многоканальный)

Факс: 8 (812) 320-03-32

Электронная почта: [ocean@oceanchips.ru](mailto:ocean@oceanchips.ru)

Web: <http://oceanchips.ru/>

Адрес: 198099, г. Санкт-Петербург, ул. Калинина, д. 2, корп. 4, лит. А