

Product Summary

BV_{DSS}	$R_{DS(ON)}$ Max	I_D Max $T_C = +25^\circ C$
100V	15m Ω @ $V_{GS} = 10V$	34A
	19.5m Ω @ $V_{GS} = 6V$	32A

Description and Applications

This new generation N-Channel Enhancement Mode MOSFET is designed to minimize $R_{DS(ON)}$ and yet maintain superior switching performance. This device is ideal for use in Notebook battery power management and Load switch.

- Backlighting
- Power Management Functions
- DC-DC Converters

Features and Benefits

- 100% Unclamped Inductive Switch (UIS) Test in Production
- High Conversion Efficiency
- Low $R_{DS(ON)}$ – Minimizes On State Losses
- Low Input Capacitance
- Fast Switching Speed
- **Totally Lead-Free & Fully RoHS Compliant (Notes 1 & 2)**
- **Halogen and Antimony Free. "Green" Device (Note 3)**

Mechanical Data

- Case: V-DFN3333-8 (Type B)
- Case Material: Molded Plastic, "Green" Molding Compound. UL Flammability Classification Rating 94V-0
- Moisture Sensitivity: Level 1 per J-STD-020
- Terminal Connections Indicator: See Below Diagram
Terminals: Finish –NiPdAu over Copper Leadframe. Solderable per MIL-STD-202, Method 208
- Weight: 0.03 grams (Approximate)

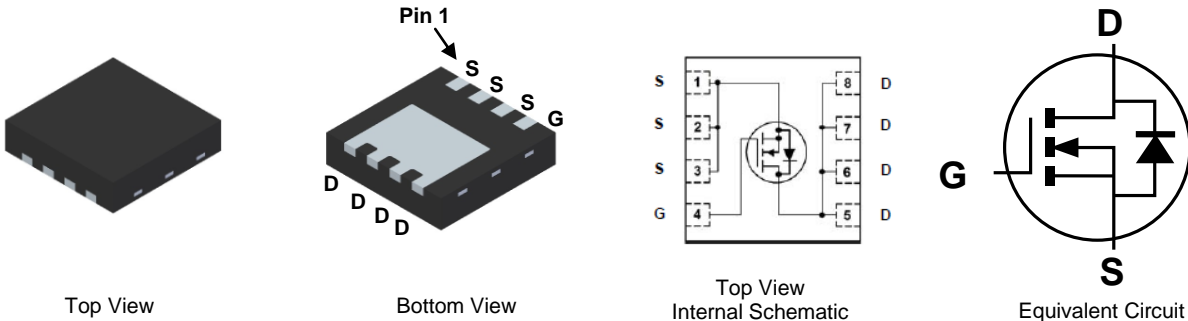

Ordering Information (Note 4)

Part Number	Case	Packaging
DMT10H015LCG-7	V-DFN3333-8 (Type B)	2,000/Tape & Reel
DMT10H015LCG-13	V-DFN3333-8 (Type B)	3,000/Tape & Reel

- Notes:
1. No purposely added lead. Fully EU Directive 2002/95/EC (RoHS), 2011/65/EU (RoHS 2) & 2015/863/EU (RoHS 3) compliant.
 2. See <https://www.diodes.com/quality/lead-free/> for more information about Diodes Incorporated's definitions of Halogen- and Antimony-free, "Green" and Lead-free.
 3. Halogen- and Antimony-free "Green" products are defined as those which contain <900ppm bromine, <900ppm chlorine (<1500ppm total Br + Cl) and <1000ppm antimony compounds.
 4. For packaging details, go to our website at <https://www.diodes.com/design/support/packaging/diodes-packaging/>.

Marking Information

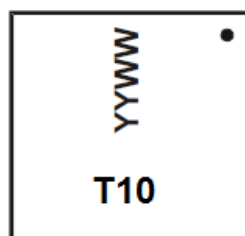

T10 = Product Type Marking Code
 YYWW = Date Code Marking
 YY = Year (ex: 18 = 2018)
 WW = Week (01 to 53)

Maximum Ratings (@T_A = +25°C, unless otherwise specified.)

Characteristic			Symbol	Value	Unit
Drain-Source Voltage			V _{DSS}	100	V
Gate-Source Voltage			V _{GSS}	±20	V
Continuous Drain Current, V _{GS} = 10V (Note 6)	Steady State	T _A = +25°C	I _D	9.4	A
		T _A = +70°C		7.5	
Continuous Drain Current, V _{GS} = 10V	Steady State	T _C = +25°C	I _D	34	A
		T _C = +100°C		21	
Maximum Continuous Body Diode Forward Current (Note 6)			I _S	1.6	A
Pulsed Drain Current (10μs Pulse, Duty Cycle = 1%)			I _{DM}	54	A
Avalanche Current, L = 3mH (Note 8)			I _{AS}	7.5	A
Avalanche Energy, L = 3mH (Note 8)			E _{AS}	85	mJ

Thermal Characteristics (@T_A = +25°C, unless otherwise specified.)

Characteristic	Symbol	Value	Unit
Total Power Dissipation (Note 5)	P _D	1	W
Thermal Resistance, Junction to Ambient (Note 5)	R _{θJA}	118	°C/W
Total Power Dissipation (Note 6)	P _D	2.1	W
Thermal Resistance, Junction to Ambient (Note 6)	R _{θJA}	59	°C/W
Thermal Resistance, Junction to Case	R _{θJC}	4.5	°C/W
Operating and Storage Temperature Range	T _J , T _{STG}	-55 to +150	°C

Electrical Characteristics (@T_A = +25°C, unless otherwise specified.)

Characteristic	Symbol	Min	Typ	Max	Unit	Test Condition
OFF CHARACTERISTICS (Note 7)						
Drain-Source Breakdown Voltage	BV _{DSS}	100	—	—	V	V _{GS} = 0V, I _D = 1mA
Zero Gate Voltage Drain Current	I _{DSS}	—	—	1	μA	V _{DS} = 80V, V _{GS} = 0V
Gate-Source Leakage	I _{GSS}	—	—	±100	nA	V _{GS} = ±20V, V _{DS} = 0V
ON CHARACTERISTICS (Note 7)						
Gate Threshold Voltage	V _{GS(TH)}	1.4	2	3.5	V	V _{DS} = V _{GS} , I _D = 250μA
Static Drain-Source On-Resistance	R _{DS(ON)}	—	12.1	15	mΩ	V _{GS} = 10V, I _D = 20A
		—	15	19.5		V _{GS} = 6V, I _D = 20A
		—	18.9	26	mΩ	V _{GS} = 4.5V, I _D = 5A
Diode Forward Voltage	V _{SD}	—	0.9	1.3	V	V _{GS} = 0V, I _S = 20A
DYNAMIC CHARACTERISTICS (Note 8)						
Input Capacitance	C _{iSS}	—	1871	—	pF	V _{DS} = 50V, V _{GS} = 0V f = 1MHz
Output Capacitance	C _{oSS}	—	261	—		
Reverse Transfer Capacitance	C _{rSS}	—	6.9	—		
Gate Resistance	R _g	—	0.75	—	Ω	V _{DS} = 0V, V _{GS} = 0V, f = 1MHz
Total Gate Charge	Q _g	—	33.3	—	nC	V _{DD} = 50V, I _D = 10A, V _{GS} = 10V
Gate-Source Charge	Q _{gs}	—	6.9	—		
Gate-Drain Charge	Q _{gd}	—	5.1	—		
Turn-On Delay Time	t _{D(ON)}	—	6.5	—	ns	V _{DD} = 50V, V _{GS} = 10V, I _D = 10A, R _g = 6Ω
Turn-On Rise Time	t _r	—	7	—		
Turn-Off Delay Time	t _{D(OFF)}	—	19.7	—		
Turn-Off Fall Time	t _f	—	8.1	—		
Reverse Recovery Time	t _{RR}	—	37.9	—	ns	I _F = 10A, di/dt = 100A/μs
Reverse Recovery Charge	Q _{RR}	—	51.9	—	nC	

- Notes:
- Device mounted on FR-4 substrate PC board, 2oz copper, with minimum recommended pad layout.
 - Device mounted on FR-4 substrate PC board, 2oz copper, with 1inch square copper plate.
 - Short duration pulse test used to minimize self-heating effect.
 - Guaranteed by design. Not subject to product testing.

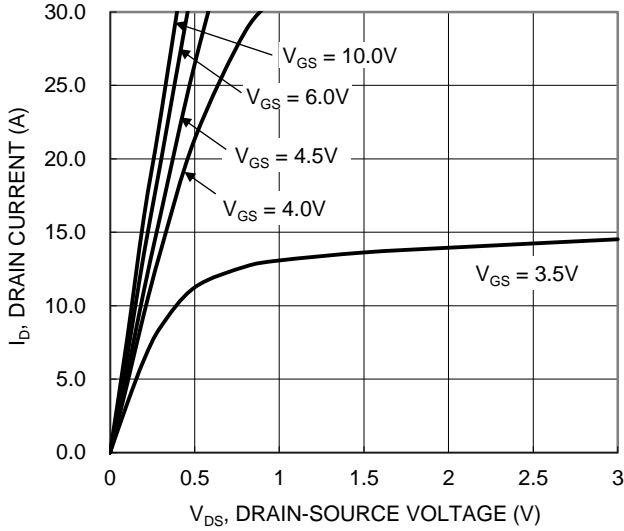

Figure 1. Typical Output Characteristic

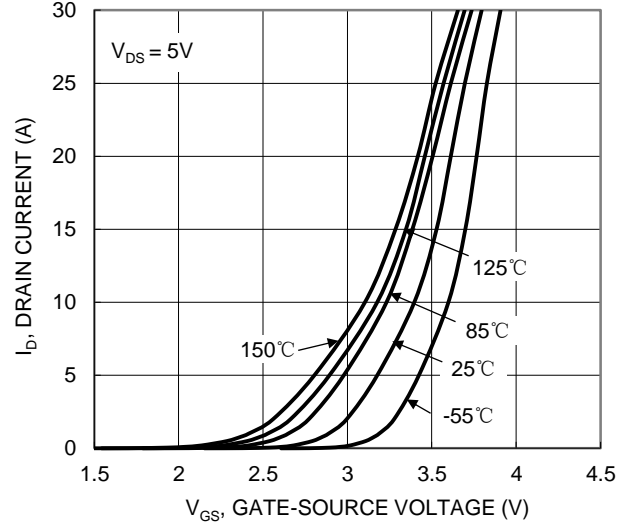

Figure 2. Typical Transfer Characteristic

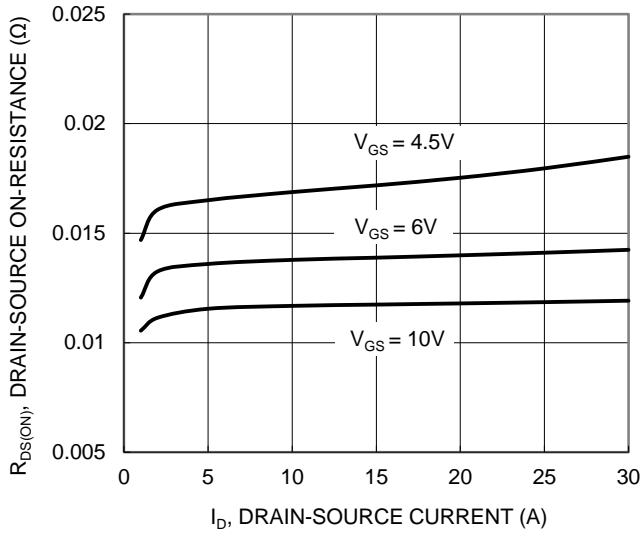

Figure 3. Typical On-Resistance vs. Drain Current and Gate Voltage

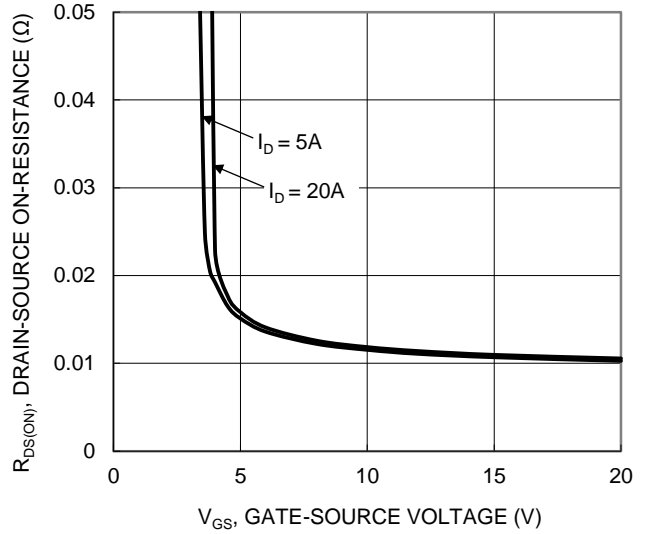

Figure 4. Typical Transfer Characteristic

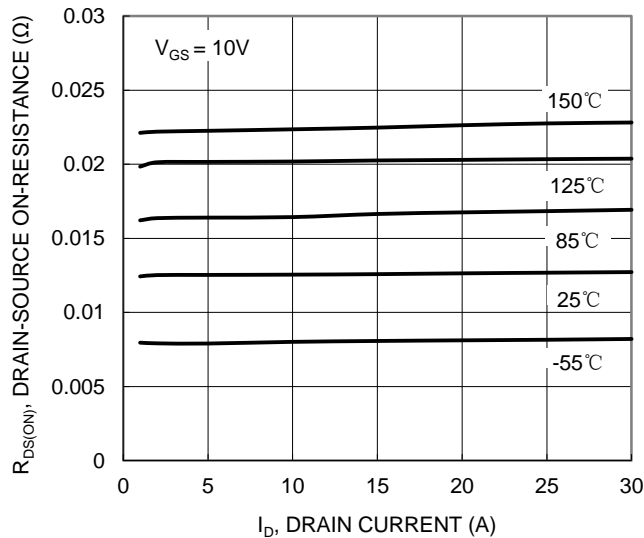

Figure 5. Typical On-Resistance vs. Drain Current and Junction Temperature

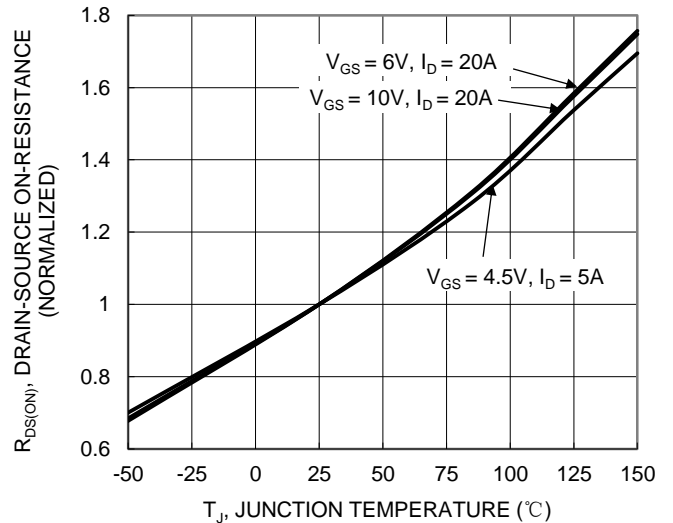

Figure 6. On-Resistance Variation with Junction Temperature

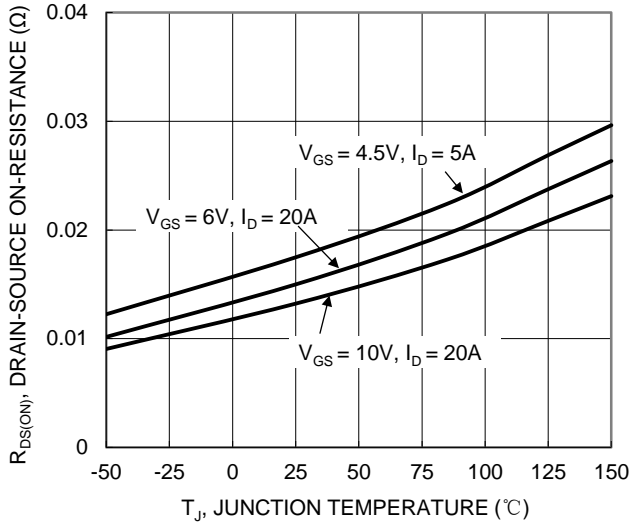

Figure 7. On-Resistance Variation with Junction Temperature

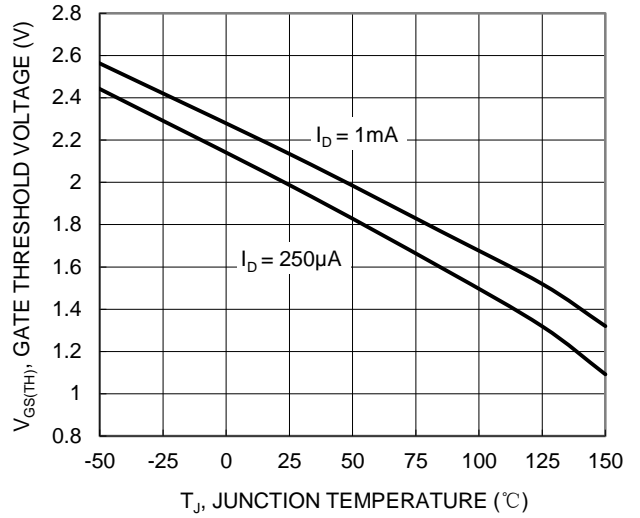

Figure 8. Gate Threshold Variation vs. Junction Temperature

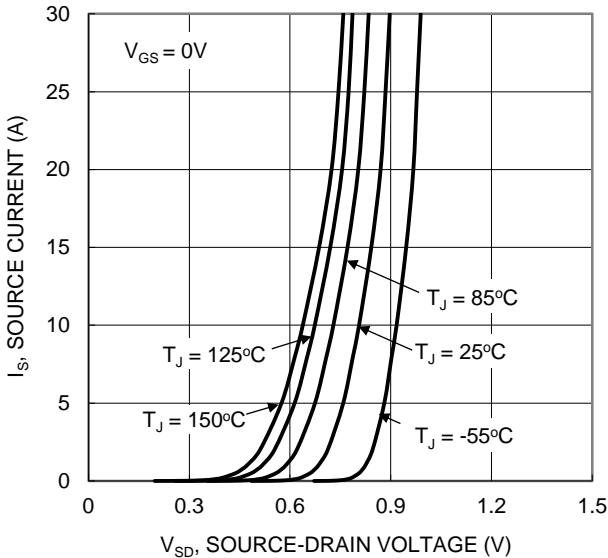

Figure 9. Diode Forward Voltage vs. Current

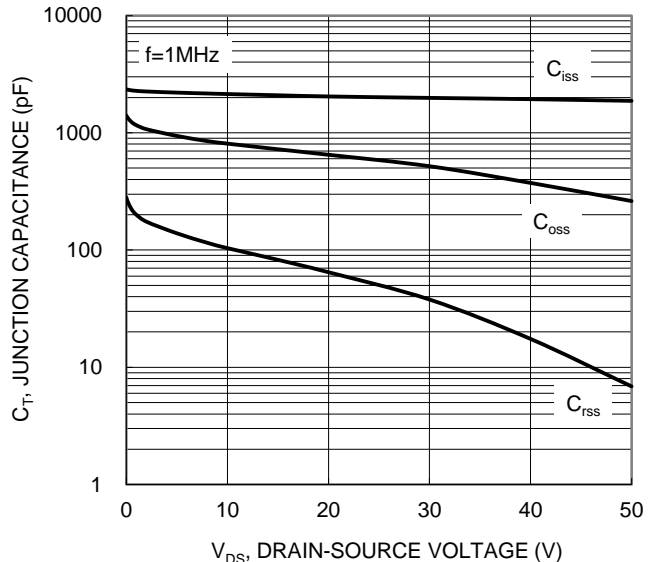

Figure 10. Typical Junction Capacitance

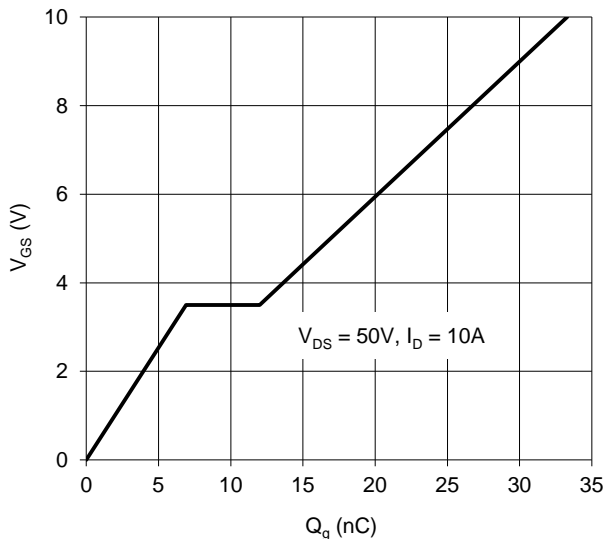

Figure 11. Gate Charge

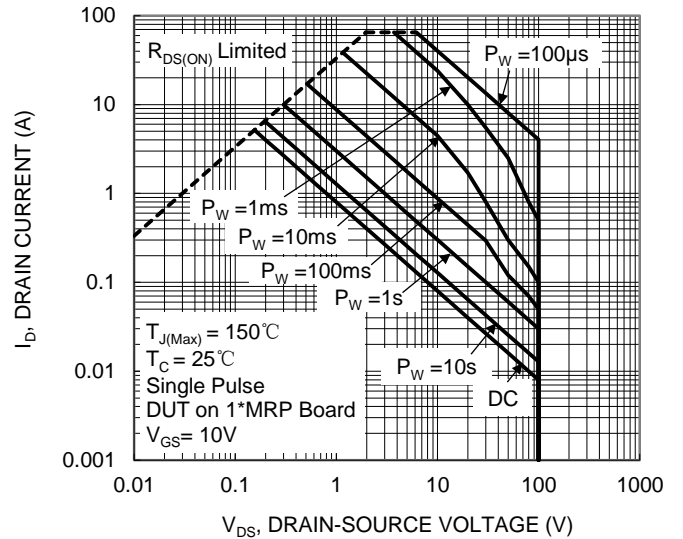

Figure 12. SOA, Safe Operation Area

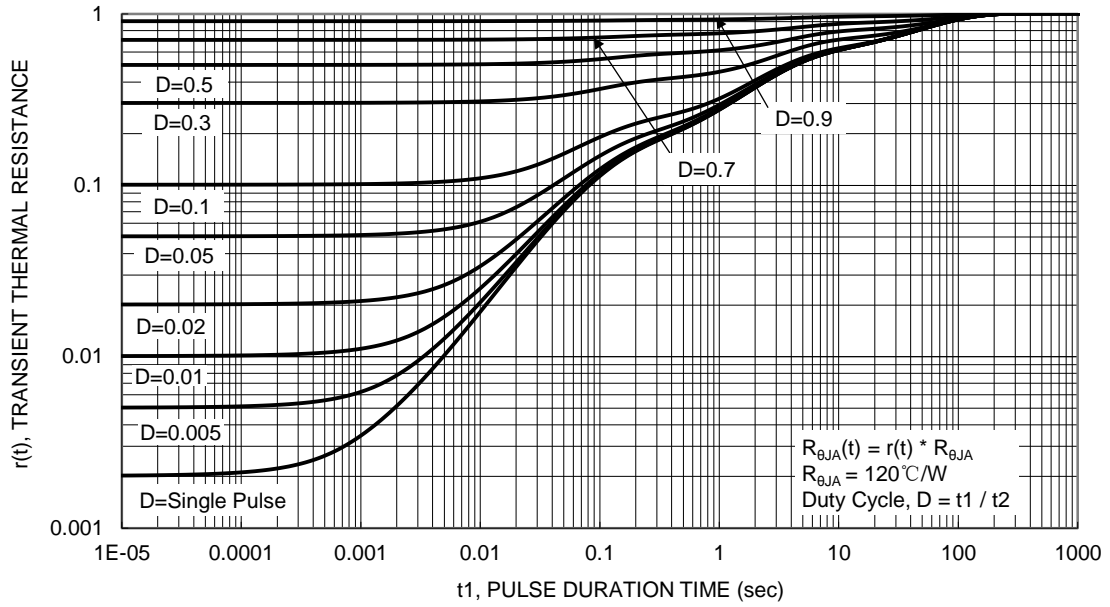
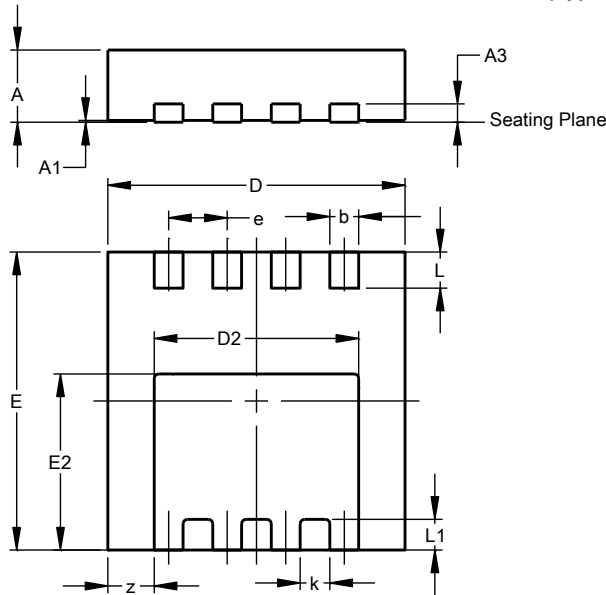

Figure 13. Transient Thermal Resistance

Package Outline Dimensions

Please see <http://www.diodes.com/package-outlines.html> for the latest version.

V-DFN3333-8 (Type B)



V-DFN3333-8 (Type B)			
Dim	Min	Max	Typ
A	0.75	0.85	0.80
A1	0.00	0.05	0.02
A3	--	--	0.203
b	0.27	0.37	0.32
D	3.25	3.35	3.30
D2	2.17	2.37	2.27
E	3.25	3.35	3.30
E2	1.85	2.05	1.95
e	--	--	0.65
k	--	--	0.33
L	0.35	0.45	0.40
L1	--	--	0.34
z	--	--	0.515
All Dimensions in mm			

Suggested Pad Layout

Please see <http://www.diodes.com/package-outlines.html> for the latest version.

V-DFN3333-8 (Type B)

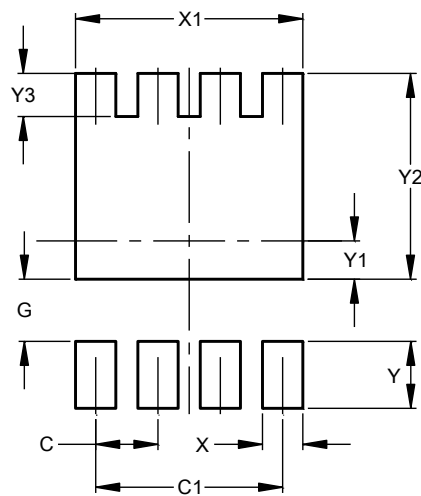

Dimensions	Value (in mm)
C	0.650
C1	1.950
G	0.650
X	0.420
X1	2.370
Y	0.700
Y1	0.400
Y2	2.150
Y3	0.450

IMPORTANT NOTICE

DIODES INCORPORATED MAKES NO WARRANTY OF ANY KIND, EXPRESS OR IMPLIED, WITH REGARDS TO THIS DOCUMENT, INCLUDING, BUT NOT LIMITED TO, THE IMPLIED WARRANTIES OF MERCHANTABILITY AND FITNESS FOR A PARTICULAR PURPOSE (AND THEIR EQUIVALENTS UNDER THE LAWS OF ANY JURISDICTION).

Diodes Incorporated and its subsidiaries reserve the right to make modifications, enhancements, improvements, corrections or other changes without further notice to this document and any product described herein. Diodes Incorporated does not assume any liability arising out of the application or use of this document or any product described herein; neither does Diodes Incorporated convey any license under its patent or trademark rights, nor the rights of others. Any Customer or user of this document or products described herein in such applications shall assume all risks of such use and will agree to hold Diodes Incorporated and all the companies whose products are represented on Diodes Incorporated website, harmless against all damages.

Diodes Incorporated does not warrant or accept any liability whatsoever in respect of any products purchased through unauthorized sales channel. Should Customers purchase or use Diodes Incorporated products for any unintended or unauthorized application, Customers shall indemnify and hold Diodes Incorporated and its representatives harmless against all claims, damages, expenses, and attorney fees arising out of, directly or indirectly, any claim of personal injury or death associated with such unintended or unauthorized application.

Products described herein may be covered by one or more United States, international or foreign patents pending. Product names and markings noted herein may also be covered by one or more United States, international or foreign trademarks.

This document is written in English but may be translated into multiple languages for reference. Only the English version of this document is the final and determinative format released by Diodes Incorporated.

LIFE SUPPORT

Diodes Incorporated products are specifically not authorized for use as critical components in life support devices or systems without the express written approval of the Chief Executive Officer of Diodes Incorporated. As used herein:

A. Life support devices or systems are devices or systems which:

1. are intended to implant into the body, or
2. support or sustain life and whose failure to perform when properly used in accordance with instructions for use provided in the labeling can be reasonably expected to result in significant injury to the user.

B. A critical component is any component in a life support device or system whose failure to perform can be reasonably expected to cause the failure of the life support device or to affect its safety or effectiveness.

Customers represent that they have all necessary expertise in the safety and regulatory ramifications of their life support devices or systems, and acknowledge and agree that they are solely responsible for all legal, regulatory and safety-related requirements concerning their products and any use of Diodes Incorporated products in such safety-critical, life support devices or systems, notwithstanding any devices- or systems-related information or support that may be provided by Diodes Incorporated. Further, Customers must fully indemnify Diodes Incorporated and its representatives against any damages arising out of the use of Diodes Incorporated products in such safety-critical, life support devices or systems.

Copyright © 2018, Diodes Incorporated

www.diodes.com

Компания «Океан Электроники» предлагает заключение долгосрочных отношений при поставках импортных электронных компонентов на взаимовыгодных условиях!

Наши преимущества:

- Поставка оригинальных импортных электронных компонентов напрямую с производств Америки, Европы и Азии, а так же с крупнейших складов мира;
- Широкая линейка поставок активных и пассивных импортных электронных компонентов (более 30 млн. наименований);
- Поставка сложных, дефицитных, либо снятых с производства позиций;
- Оперативные сроки поставки под заказ (от 5 рабочих дней);
- Экспресс доставка в любую точку России;
- Помощь Конструкторского Отдела и консультации квалифицированных инженеров;
- Техническая поддержка проекта, помощь в подборе аналогов, поставка прототипов;
- Поставка электронных компонентов под контролем ВП;
- Система менеджмента качества сертифицирована по Международному стандарту ISO 9001;
- При необходимости вся продукция военного и аэрокосмического назначения проходит испытания и сертификацию в лаборатории (по согласованию с заказчиком);
- Поставка специализированных компонентов военного и аэрокосмического уровня качества (Xilinx, Altera, Analog Devices, Intersil, Interpoint, Microsemi, Actel, Aeroflex, Peregrine, VPT, Syfer, Eurofarad, Texas Instruments, MS Kennedy, Miteq, Cobham, E2V, MA-COM, Hittite, Mini-Circuits, General Dynamics и др.);

Компания «Океан Электроники» является официальным дистрибьютором и эксклюзивным представителем в России одного из крупнейших производителей разъемов военного и аэрокосмического назначения «JONHON», а так же официальным дистрибьютором и эксклюзивным представителем в России производителя высокотехнологичных и надежных решений для передачи СВЧ сигналов «FORSTAR».



JONHON

«JONHON» (основан в 1970 г.)

Разъемы специального, военного и аэрокосмического назначения:

(Применяются в военной, авиационной, аэрокосмической, морской, железнодорожной, горно- и нефтедобывающей отраслях промышленности)

«FORSTAR» (основан в 1998 г.)

ВЧ соединители, коаксиальные кабели, кабельные сборки и микроволновые компоненты:

(Применяются в телекоммуникациях гражданского и специального назначения, в средствах связи, РЛС, а так же военной, авиационной и аэрокосмической отраслях промышленности).



Телефон: 8 (812) 309-75-97 (многоканальный)

Факс: 8 (812) 320-03-32

Электронная почта: ocean@oceanchips.ru

Web: <http://oceanchips.ru/>

Адрес: 198099, г. Санкт-Петербург, ул. Калинина, д. 2, корп. 4, лит. А