



Temperature protection devices

# Chip NTC thermistor

Commercial grade

# NTCG series

---

|                  |                            |
|------------------|----------------------------|
| <b>NTCG 0603</b> | <b>JIS 0603 [EIA 0201]</b> |
| <b>NTCG 1005</b> | <b>JIS 1005 [EIA 0402]</b> |
| <b>NTCG 1608</b> | <b>JIS 1608 [EIA 0603]</b> |
| <b>NTCG 2012</b> | <b>JIS 2012 [EIA 0805]</b> |

---

## REMINDERS FOR USING THESE PRODUCTS

Before using these products, be sure to request the delivery specifications.

### SAFETY REMINDERS

Please pay sufficient attention to the warnings for safe designing when using this products.

#### REMINDERS

Incorrect usage may lead to destroyed NTC thermistors and damages or malfunctions with the devices used.

- Please use them within the ranges of the ratings and performance provided in the catalog and delivery specifications upon confirming the environments where they are to be used and installed.
- Do not use them outside the operating temperature range.
- Do not use them with the ratings or maximum permissible power levels exceeded.
- Do not quickly apply 5mW or more of load with the constant-voltage power supply in the NTC thermistors as this may lead to staying in thermal runaway mode or the red-shortening of chips.
- Please be cautious of the applied voltage in thermistors as instruments may malfunction with the lowering of resistance due to self heating.
- With instruments that consumers can touch the thermistors with their hands, please carefully warn them not to touch the thermistors.
- Store them in locations where the temperature is 10°C to +40°C and the relative humidity is 75% or below, avoid environments where there are sudden changes in temperatures, direct sunlight, corrosive gas, grit, or dust, and keep them packed in a manner where no loading stress is applied in order to avoid deterioration and damage. (please use them within six months.)
- When sealing thermistors, please do so upon first considering the type, quantity, hardening conditions, and adhesiveness of the sealing material and confirming its reliability.
- Avoid powerful vibrations, impact (such as by dropping), pressure, etc. on thermistors that exceed the prescribed levels.
- Do not use them for long periods of time in environments with a relative humidity of over 85%. (this excludes cases where countermeasures have been taken.)
- Do not use them in the following environments. (this excludes cases where countermeasures have been taken.)
  - Corrosive gases (Cl<sub>2</sub>, NH<sub>3</sub>, SO<sub>x</sub>, NO<sub>x</sub>, etc.)
  - Environments with highly conductive substances (electrolytes, water, saltwater, etc.)
  - Environments with acid, alkali, or organic solvents
  - Dusty areas
- Please observe the following precautions when attaching them to substrates as failure to do so may result in destruction or malfunction.
  - Do not let the substrates get warped or twisted at any time during the soldering.
  - The landing size must be even on both the left and right sides.
  - Do not use items that have been dropped or detached.
  - Do not allow the adherence of more solder than needed.
- Reflow mounting is recommended with NTC thermistors, and not flow (dip) mounting.
- Attaching or making corrections with a soldering iron is not recommended as it can lead to troubles such as significant distorting due to thermal shock or cracking. If a soldering iron must be used, it should be 20W or below with the temperature of the tip at 350°C or below, and at a maximum of 5 seconds of soldering time. Also, do not let the tip of the soldering iron come in direct contact with the chips.
- Please use a substance such as resin that does not generate hydrogen (H<sub>2</sub>) when forming insulation film over chips.
- Please contact our sales offices when considering the use of the products listed on this catalog for applications, whose performance and/or quality require a more stringent level of safety or reliability, or whose failure, malfunction or trouble could cause serious damage to society, person or property ('specific uses' such as automobiles, airplanes, medical instruments, nuclear devices, etc.) as well as when considering the use for applications that exceed the range and conditions of this catalog.

Please note that we are not responsible for any damages or losses incurred resulting from the use of these products that exceeds the range and conditions of this catalog or specific uses.

Please take appropriate measures such as acquiring protective circuits and devices that meet the uses, applications, and conditions of the instruments and keeping backup circuits.

# NTC thermistors

## Commercial grade

Product compatible with RoHS directive  
Compatible with lead-free solders

# Overview of the NTCG series

### CHARACTERISTICS OF NTC THERMISTORS

NTC(Negative Temperature Coefficient) thermistors are manufactured from sintered metal oxides. Each thermistor consists of a combination of two to four of the following materials: manganese, nickel, cobalt and copper. NTC thermistors are semiconductor resistors that exhibit decreasing resistance characteristics with increasing temperature. TDK thermistors have low thermal time constants which result in extremely high rates of resistance change to accurately track the temperature.

### FEATURES OF NTCG SERIES

- 0603 to 2012mm wide lineup
- 125°C
- UL1434 acquisition (File No.E250289)

Fig.1 R-T Curve : 10kohm@25°C

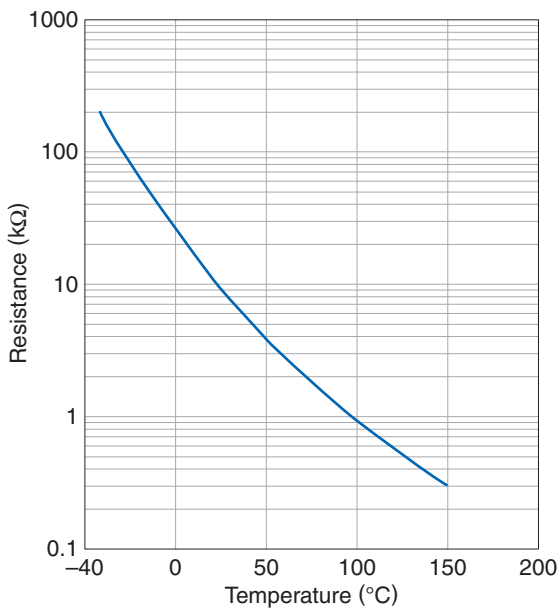

Fig.2 Internal structure of the multilayer chip thermistors



| No. | Name                   |
|-----|------------------------|
| (1) | Semiconductor ceramics |
| (2) | Internal electrode(Pd) |
| (3) | Ag                     |
| (4) | Terminal electrode Ni  |
| (5) | Sn                     |

○ RoHS Directive Compliant Product: See the following for more details. <https://product.tdk.com/info/en/environment/rohs/index.html>

⚠ Please be sure to request delivery specifications that provide further details on the features and specifications of the products for proper and safe use. Please note that the contents may change without any prior notice due to reasons such as upgrading.

# NTC thermistors

## Commercial grade

Product compatible with RoHS directive  
Compatible with lead-free solders

# Overview of the NTCG series

## APPLICATIONS

### Smart phones



### Battery



### Wireless charger



### LED



## COMMERCIAL GRADE

| Type    | Dimensions Code JIS[EIA] | Use circuit example | Various-circuit temperature compensated circuit |                  |                 | PA, PMIC       |
|---------|--------------------------|---------------------|---|------------------|-----------------|----------------|
|         |                          |                     | Circuit example                                 | Target           | Vout            | Vout           |
|         |                          |                     |   |                  |                 |                |
|         |                          | Resistance(R25)     | 1kΩ   | 22kΩ             | 68kΩ            | 10kΩ           |
|         |                          | B constant (B25/85) | 3100K to 4100K                                  | 3435K to 4550K   | 4000K to 4550K  | 3435K to 4100K |
| General | 0603 [0201]              | N/A                 | NTCG063JF223HTBX                                | NTCG064EF683FTBX | NTCG064BH103HTB |                |
|         | 1005 [0402]              | NTCG104BH102HT1     | NTCG104LH223HT1                                 | NTCG104BF683FT1X | NTCG104BH103HT1 |                |
|         | 1608 [0603]              | NTCG164BH102HT1     | NTCG164LH223HT1                                 | NTCG164LH683HT1  | NTCG164BH103HT1 |                |

| Type    | Dimensions Code JIS[EIA] | Use circuit example | BMS              | LCD              | LED            |
|---------|--------------------------|---------------------|------------------|------------------|----------------|
|         |                          |                     | Circuit example  | Target           | Vout           |
|         |                          |                     |                  |                  |                |
|         |                          | Resistance(R25)     | 10kΩ             | 47kΩ             | 100kΩ          |
|         |                          | B constant (B25/85) | 3435K to 4100K   | 4000K to 4550K   | 4150K to 4550K |
| General | 0603 [0201]              | NTCG063JF103FTB     | NTCG064BF473FTBX | NTCG064EF104FTBX |                |
|         | 1005 [0402]              | NTCG103JF103FT1     | NTCG104BF473FT1X | NTCG104EF104FT1X |                |
|         | 1608 [0603]              | NTCG163JF103FT1     | NTCG164BF473FT1  | NTCG164KF104FT1  |                |

Please be sure to request delivery specifications that provide further details on the features and specifications of the products for proper and safe use.  
Please note that the contents may change without any prior notice due to reasons such as upgrading.

# NTC thermistors

Product compatible with RoHS directive  
Compatible with lead-free solders

## Commercial grade

# Overview of the NTCG series

### PART NUMBER CONSTRUCTION

| NTC            | G   | ○○                              | 3E          | H                        | 101                    | □                                | T               | □□□   |
|----------------|---|---------------------------------|-------------|--------------------------|------------------------|----------------------------------|-----------------|---|
| Series name    | Structural classification   | shapes and dimensions Code (mm) | B constant* | B constant tolerance (%) | Nominal resistance (Ω) | Nominal resistance tolerance (%) | Packaging style | TDK internal code   |
| NTC thermistor | G<br>Multilayer internal electroded chip type NTC thermistor (Pb free type) | 06 0603                         |             | X ±0.7                   | 300 30                 | D ±0.5                           | T Taping        | 1 Commercial grade (other than 0603mm) B constant: 25/85°C  |
|                |   | 10 1005                         |             | F ±1                     | 101 100                | F ±1                             |                 | 1X Commercial grade (other than 0603mm) B constant: 25/50°C |
|                |   | 16 1608                         |             | H ±3                     | 102 1000 (1kΩ)         | H ±3                             |                 | B Commercial grade (0603mm) B constant: 25/85°C             |
|                |   | 20 2012                         |             | J ±5                     | 103 10000 (10kΩ)       | J ±5                             |                 | BX Commercial grade (0603mm) B constant: 25/50°C            |

\* B constant

| B constant (K) |              |    |              |
|----------------|--------------|----|--------------|
| 2A             | 2000 to 2050 | 3A | 3000 to 3050 |
| 2B             | 2051 to 2100 | 3B | 3051 to 3100 |
| 2C             | 2101 to 2150 | 3C | 3101 to 3150 |
| 2E             | 2201 to 2250 | 3E | 3201 to 3250 |
| 2F             | 2251 to 2300 | 3F | 3251 to 3300 |
| 2J             | 2401 to 2450 | 3J | 3401 to 3450 |
| 2K             | 2451 to 2500 | 3K | 3451 to 3500 |
| 2L             | 2501 to 2550 | 3L | 3501 to 3550 |
| 2N             | 2601 to 2650 | 3N | 3601 to 3650 |
| 2Q             | 2701 to 2750 | 3Q | 3701 to 3750 |
| 2S             | 2801 to 2850 | 3S | 3801 to 3850 |
|                |              | 4A | 4000 to 4050 |
|                |              | 4B | 4051 to 4100 |
|                |              | 4C | 4101 to 4150 |
|                |              | 4E | 4201 to 4250 |
|                |              | 4F | 4251 to 4300 |
|                |              | 4J | 4401 to 4450 |
|                |              | 4K | 4451 to 4500 |
|                |              | 4L | 4501 to 4550 |
|                |              | 4N | 4601 to 4650 |
|                |              | 4Q | 4701 to 4750 |
|                |              | 4S | 4801 to 4850 |

The B constant indicates the magnitude of a change in a zero-load resistance value to a temperature, and is obtained based on arbitrary two temperatures in resistance-to-temperature characteristics.

B constant calculation formula

$$B = \frac{\ln R_1 - \ln R_2}{(1/T_1) - (1/T_2)}$$

B: B constant (K)  
 T1: Arbitrary temperature (K)  
 T2: Arbitrary temperature different from T1 (K)  
 R1: Zero-load resistance value at temperature T1 (Ω)  
 R2: Zero-load resistance value at temperature T2 (Ω)  
 Each temperature is measured in absolute temperature. 0°C=273.15K

| Shape symbol (JIS) | Dimensions in mm |           |           |           |
|--------------------|------------------|-----------|-----------|-----------|
|                    | L                | W         | T         | B         |
| 0603               | 0.60±0.03        | 0.30±0.03 | 0.30±0.03 | 0.15±0.05 |
| 1005               | 1.00±0.05        | 0.50±0.05 | 0.50±0.05 | 0.1min    |
| 1608               | 1.60±0.10        | 0.80±0.10 | 0.80±0.10 | 0.2min    |
| 2012               | 2.00±0.20        | 1.25±0.20 | 0.70±0.20 | 0.2min    |



### OPERATING TEMPERATURE RANGE, PACKAGE QUANTITY, PRODUCT WEIGHT

| Type   | Temperature range           |                            | Package quantity (pieces/reel) | Individual weight (mg) |
|--------|-----------------------------|----------------------------|--------------------------------|------------------------|
|        | Operating temperature* (°C) | Storage temperature** (°C) |                                |                        |
| NTCG06 | -40 to 125                  | -40 to 125                 | 15,000                         | 0.3                    |
| NTCG10 |                             |                            | 10,000                         | 1.3                    |
| NTCG16 |                             |                            | 4,000                          | 5.0                    |
| NTCG20 |                             |                            | 2,000                          | 7.2                    |

\* Operating temperature range includes self-temperature rise.

\*\* The storage temperature range is for after the assembly.

Please be sure to request delivery specifications that provide further details on the features and specifications of the products for proper and safe use.  
Please note that the contents may change without any prior notice due to reasons such as upgrading.

# NTC thermistors

## Commercial grade

Product compatible with RoHS directive  
Compatible with lead-free solders

# Characteristic map of NTCG series

## ■ COMMERCIAL GRADE (RESISTANCE: 22 to 10kΩ )

| Resistance | Dimensions [JIS] | Thickness (mm) | B constant |            | Catalog number               |                            |                            |                            |                 |
|------------|------------------|----------------|------------|------------|------------------------------|----------------------------|----------------------------|----------------------------|-----------------|
|            |                  |                | [25/ 85°C] | [25/ 50°C] | Resistance tolerance: ± 0.5% | Resistance tolerance: ± 1% | Resistance tolerance: ± 3% | Resistance tolerance: ± 5% |                 |
| 22Ω        | 1005             | 0.5 ± 0.05     |            |            |                              |                            |                            | NTCG103EH220JT1            |                 |
| 30Ω        | 1005             | 0.5 ± 0.05     |            |            |                              |                            |                            | NTCG103EH300JT1            |                 |
|            | 1608             | 0.8 ± 0.1      |            |            |                              |                            |                            | NTCG163EH300JT1            |                 |
| 40Ω        | 0603             | 0.3 ± 0.03     | 3,250 K    | 3,244 K    |                              |                            |                            | NTCG063EH400HTB            |                 |
|            | 1005             | 0.5 ± 0.05     |            |            |                              |                            |                            | NTCG103EH400HT1            |                 |
| 47Ω        | 1608             | 0.8 ± 0.1      |            |            |                              |                            |                            | NTCG163EH400HT1            |                 |
|            | 1005             | 0.5 ± 0.05     |            |            |                              |                            |                            | NTCG103EH470JT1            |                 |
| 100Ω       | 1005             | 0.5 ± 0.05     | 3,250 K    | 3,244 K    |                              |                            |                            | NTCG103EH101HT1            |                 |
|            | 1608             | 0.8 ± 0.1      |            |            |                              |                            |                            | NTCG163EH101HT1            |                 |
| 150Ω       | 1608             | 0.8 ± 0.1      | 3,250 K    | 3,244 K    |                              |                            |                            | NTCG163EH151JT1            |                 |
| 220Ω       | 1608             | 0.8 ± 0.1      |            |            |                              |                            |                            | NTCG163NH221JT1            |                 |
| 330Ω       | 1608             | 0.8 ± 0.1      | 3,650 K    | 3,642 K    |                              |                            |                            | NTCG163NH331JT1            |                 |
|            | 1005             | 0.5 ± 0.05     |            |            |                              |                            |                            | NTCG103NH471JT1            |                 |
| 470Ω       | 1608             | 0.8 ± 0.1      |            |            |                              |                            |                            | NTCG163NH471JT1            |                 |
|            | 2012             | 0.7 ± 0.2      | 3,250 K    | 3,231 K    |                              |                            |                            | NTCG203EH471JT1            |                 |
| 680Ω       | 1005             | 0.5 ± 0.05     | 3,650 K    | 3,642 K    |                              |                            |                            | NTCG103NH681JT1            |                 |
|            | 2012             | 0.7 ± 0.2      | 3,250 K    | 3,231 K    |                              |                            |                            | NTCG203EH681JT1            |                 |
| 1kΩ        | 1005             | 0.5 ± 0.05     | 4,100 K    | 4,096 K    |                              |                            |                            | NTCG104BH102HT1            |                 |
|            | 1608             | 0.8 ± 0.1      |            |            |                              |                            |                            | NTCG164BH102HT1            |                 |
| 1.5kΩ      | 2012             | 0.7 ± 0.2      | 3,100 K    | 3,057 K    |                              |                            |                            | NTCG203BH102JT1            |                 |
|            | 1005             | 0.5 ± 0.05     | 4,100 K    | 4,096 K    |                              |                            |                            | NTCG104BH152JT1            |                 |
| 2.2kΩ      | 2012             | 0.7 ± 0.2      | 3,100 K    | 3,057 K    |                              |                            |                            | NTCG203BH152JT1            |                 |
|            | 1005             | 0.5 ± 0.05     | 4,100 K    | 4,096 K    |                              |                            |                            | NTCG104BH222JT1            |                 |
| 3kΩ        | 1608             | 0.8 ± 0.1      | 3,300 K    | 3,248 K    |                              |                            |                            | NTCG164BH222JT1            |                 |
|            | 2012             | 0.7 ± 0.2      | 3,300 K    | 3,248 K    |                              |                            |                            | NTCG203FH222JT1            |                 |
| 3.3kΩ      | 1608             | 0.8 ± 0.1      | 4,100 K    | 4,067 K    |                              |                            |                            | NTCG164BH302JT1            |                 |
|            | 1005             | 0.5 ± 0.05     | 4,100 K    | 4,067 K    |                              |                            |                            | NTCG104BH332JT1            |                 |
| 4.7kΩ      | 1608             | 0.8 ± 0.1      | 3,300 K    | 3,248 K    |                              |                            |                            | NTCG164BH332JT1            |                 |
|            | 2012             | 0.7 ± 0.2      | 3,300 K    | 3,248 K    |                              |                            |                            | NTCG203FH332JT1            |                 |
| 6.8kΩ      | 1005             | 0.5 ± 0.05     | 3,545 K    | 3,500 K    |                              |                            |                            | NTCG103LH472JT1            |                 |
|            | 1608             | 0.8 ± 0.1      | 4,100 K    | 4,067 K    |                              |                            |                            | NTCG104BH472HT1            |                 |
| 10kΩ       | 2012             | 0.7 ± 0.2      | 3,450 K    | 3,393 K    |                              |                            |                            | NTCG164BH472HT1            |                 |
|            | 1005             | 0.5 ± 0.05     | 4,100 K    | 4,067 K    |                              |                            |                            | NTCG104BH472JT1            |                 |
| 10kΩ       | 1608             | 0.8 ± 0.1      | 4,100 K    | 4,067 K    |                              |                            |                            | NTCG104BH682JT1            |                 |
|            | 2012             | 0.7 ± 0.2      | 3,450 K    | 3,393 K    |                              |                            |                            | NTCG203JH682JT1            |                 |
| 10kΩ       | 0603             | 0.3 ± 0.03     | 3,435 K    | 3,380 K    |                              |                            |                            | NTCG063JF103FTB            |                 |
|            |                  |                | 3,950 K    | 3,888 K    |                              |                            |                            | NTCG063JH103HTB            |                 |
|            |                  |                | 4,100 K    | 4,067 K    |                              |                            |                            | NTCG063UH103HTBX           |                 |
|            | 1005             | 0.5 ± 0.05     | 3,435 K    | 3,380 K    |                              |                            |                            | NTCG064BH103HTB            |                 |
|            |                  |                | 3,950 K    | 3,888 K    | NTCG103JX103DT1              | NTCG103JF103FT1            |                            |                            | NTCG103JF103HT1 |
|            |                  |                | 4,100 K    | 4,067 K    |                              |                            |                            |                            | NTCG103JH103HT1 |
|            | 1608             | 0.8 ± 0.1      | 3,435 K    | 3,380 K    |                              |                            |                            | NTCG103UH103HT1            |                 |
|            |                  |                | 3,950 K    | 3,888 K    |                              |                            |                            |                            | NTCG103UH103JT1 |
|            |                  |                | 4,100 K    | 4,067 K    |                              |                            |                            |                            | NTCG103UH103JT1 |
|            | 2012             | 0.7 ± 0.2      | 3,435 K    | 3,380 K    |                              |                            |                            | NTCG104BH103HT1            |                 |
|            |                  |                | 3,950 K    | 3,888 K    |                              |                            |                            |                            | NTCG104BH103JT1 |
|            |                  |                | 4,100 K    | 4,067 K    |                              |                            |                            |                            | NTCG104BH103JT1 |
| 2012       | 0.7 ± 0.2        | 3,435 K        | 3,380 K    |            |                              |                            | NTCG163JF103FT1            |                            |                 |
|            |                  | 3,950 K        | 3,888 K    |            |                              |                            |                            | NTCG163JH103HT1            |                 |
|            |                  | 4,100 K        | 4,067 K    |            |                              |                            |                            | NTCG163JH103JT1            |                 |
| 2012       | 0.7 ± 0.2        | 3,435 K        | 3,380 K    |            |                              |                            | NTCG163JF103FT1            |                            |                 |
|            |                  | 3,950 K        | 3,888 K    |            |                              |                            |                            | NTCG163JH103HT1            |                 |
|            |                  | 4,100 K        | 4,067 K    |            |                              |                            |                            | NTCG163JH103JT1            |                 |
| 2012       | 0.7 ± 0.2        | 3,435 K        | 3,380 K    |            |                              |                            | NTCG164BF103HT1            |                            |                 |
|            |                  | 3,950 K        | 3,888 K    |            |                              |                            |                            | NTCG164BH103HT1            |                 |
|            |                  | 4,100 K        | 4,067 K    |            |                              |                            |                            | NTCG164BH103JT1            |                 |
| 2012       | 0.7 ± 0.2        | 3,650 K        | 3,589 K    |            |                              |                            | NTCG203NH103JT1            |                            |                 |

⚠ Please be sure to request delivery specifications that provide further details on the features and specifications of the products for proper and safe use.  
Please note that the contents may change without any prior notice due to reasons such as upgrading.

# NTC thermistors

Product compatible with RoHS directive  
Compatible with lead-free solders

## Commercial grade

# Characteristic map of NTCG series

### ■ COMMERCIAL GRADE (RESISTANCE: 15k to 1000kΩ)

| Resistance | Dimensions [JIS] | Thickness (mm) | B constant |            | Catalog number               |                            |                            |                            |
|------------|------------------|----------------|------------|------------|------------------------------|----------------------------|----------------------------|----------------------------|
|            |                  |                | [25/ 85°C] | [25/ 50°C] | Resistance tolerance: ± 0.5% | Resistance tolerance: ± 1% | Resistance tolerance: ± 3% | Resistance tolerance: ± 5% |
| 15kΩ       | 1005             | 0.5 ± 0.05     | 4,100 K    | 4,067 K    |                              |                            | NTCG104BH153HT1            | NTCG104BH153JT1            |
|            | 1608             | 0.8 ± 0.1      |            |            |                              |                            |                            | NTCG164BH153JT1            |
|            | 2012             | 0.7 ± 0.2      | 4,150 K    | 4,085 K    |                              |                            |                            | NTCG203NH153JT1            |
| 22kΩ       | 0603             | 0.3 ± 0.03     | 3,435 K    | 3,380 K    |                              |                            | NTCG063JF223HTBX           |                            |
|            | 1005             | 0.5 ± 0.05     | 4,550 K    | 4,485 K    |                              |                            | NTCG104LH223HT1            | NTCG104LH223JT1            |
|            | 1608             | 0.8 ± 0.1      |            |            |                              |                            | NTCG164LH223HT1            | NTCG164LH223JT1            |
|            | 2012             | 0.7 ± 0.2      | 3,850 K    | 3,783 K    |                              |                            |                            | NTCG203SH223JT1            |
| 33kΩ       | 1005             | 0.5 ± 0.05     | 4,550 K    | 4,485 K    |                              |                            |                            | NTCG104LH333JT1            |
|            | 1608             | 0.8 ± 0.1      |            |            |                              |                            |                            | NTCG164LH333JT1            |
|            | 2012             | 0.7 ± 0.2      | 3,850 K    | 3,783 K    |                              |                            |                            | NTCG203SH333JT1            |
| 47kΩ       | 0603             | 0.3 ± 0.03     | 4,114 K    | 4,050 K    |                              | NTCG064BF473FTBX           | NTCG064BF473HTBX           | NTCG064BF473JTBX           |
|            | 1005             | 0.5 ± 0.05     | 4,114 K    | 4,050 K    |                              | NTCG104BF473FT1X           | NTCG104BF473HT1X           | NTCG104BF473JT1X           |
|            |                  |                | 4,550 K    | 4,485 K    |                              |                            | NTCG104LH473HT1            | NTCG104LH473JT1            |
|            | 1608             | 0.8 ± 0.1      | 4,550 K    | 4,485 K    |                              |                            | NTCG164LH473HT1            | NTCG164LH473JT1            |
|            | 2012             | 0.7 ± 0.2      | 4,000 K    | 3,930 K    |                              |                            |                            | NTCG204AH473JT1            |
| 68kΩ       | 0603             | 0.3 ± 0.03     | 4,308 K    | 4,250 K    |                              | NTCG064EF683FTBX           |                            | NTCG064EF683JTBX           |
|            | 1005             | 0.5 ± 0.05     | 4,150 K    | 4,085 K    |                              | NTCG104BF683FT1X           | NTCG104BF683HT1X           | NTCG104BF683JT1X           |
|            |                  |                | 4,550 K    | 4,485 K    |                              |                            | NTCG104LH683HT1            | NTCG104LH683JT1            |
|            | 1608             | 0.8 ± 0.1      |            |            |                              |                            | NTCG164LH683HT1            | NTCG164LH683JT1            |
| 2012       | 0.7 ± 0.2        | 4,000 K        | 3,930 K    |            |                              |                            | NTCG204AH683JT1            |                            |
| 100kΩ      | 0603             | 0.3 ± 0.03     | 4,150 K    | 4,085 K    |                              |                            | NTCG064BF104FTBX           |                            |
|            |                  |                | 4,308 K    | 4,250 K    |                              |                            | NTCG064EF104FTBX           | NTCG064EF104HTBX           |
|            |                  |                | 4,550 K    | 4,485 K    |                              |                            | NTCG064LH104HTB            | NTCG064LH104JTB            |
|            | 1005             | 0.5 ± 0.05     | 4,308 K    | 4,250 K    | NTCG104ED104DT1X             | NTCG104EF104FT1X           | NTCG104EF104HT1X           | NTCG104EH104HT1X           |
|            |                  |                | 4,550 K    | 4,485 K    |                              |                            | NTCG104LH104HT1            | NTCG104LH104JT1            |
|            | 1608             | 0.8 ± 0.1      | 4,485 K    | 4,419 K    |                              | NTCG104KF104FT1            | NTCG104KF104HT1            | NTCG164LH104JT1            |
|            | 2012             | 0.7 ± 0.2      | 4,150 K    | 4,085 K    |                              | NTCG164KF104FT1            | NTCG164LH104HT1            | NTCG204CH104JT1            |
| 150kΩ      | 1005             | 0.5 ± 0.05     | 4,550 K    | 4,485 K    |                              |                            |                            | NTCG104LH154JT1            |
|            | 1608             | 0.8 ± 0.1      |            |            |                              |                            | NTCG164LH154HT1            | NTCG164LH154JT1            |
|            | 2012             | 0.7 ± 0.2      | 4,150 K    | 4,085 K    |                              |                            |                            | NTCG204CH154JT1            |
| 220kΩ      | 1005             | 0.5 ± 0.05     |            |            |                              |                            | NTCG104QH224HT1            | NTCG104QH224JT1            |
| 330kΩ      | 1608             | 0.8 ± 0.1      | 4,750 K    | 4,662 K    |                              |                            | NTCG164QH224HT1            | NTCG164QH224JT1            |
|            | 1005             | 0.5 ± 0.05     |            |            |                              |                            | NTCG104QH334HT1            | NTCG104QH334JT1            |
| 470kΩ      | 1608             | 0.8 ± 0.1      |            |            |                              |                            |                            | NTCG164QH334JT1            |
|            | 1005             | 0.5 ± 0.05     |            |            |                              |                            | NTCG104QH474HT1            | NTCG104QH474JT1            |
| 1000kΩ     | 1608             | 0.8 ± 0.1      | 4,750 K    | 4,662 K    |                              |                            | NTCG164QH474HT1            | NTCG164QH474JT1            |
|            | 1005             | 0.5 ± 0.05     |            |            |                              |                            | NTCG104QH105HT1            | NTCG104QH105JT1            |
|            | 1608             | 0.8 ± 0.1      |            |            |                              |                            | NTCG164QH105HT1            | NTCG164QH105JT1            |

### ■ RATINGS

| Size                          | mm           | 0603 | 1005 | 1608 | 2012 |
|-------------------------------|--------------|------|------|------|------|
| Maximum rated power 25°C)*1   | mW           | 100  | 100  | 100  | 200  |
| Dissipation factors (25°C) *2 | mW/°C   mW/K | 1    | 1    | 1    | 2    |

\*1 Maximum rated power: Maximum power: at rated temperature (25°C), maximum power that can be applied continuously

\*2 Dissipation factors: powered that it is equivalent that be increased in self-heating by load power thermistor at 1°C temperature

# NTC thermistors

## Commercial grade

Product compatible with RoHS directive  
Compatible with lead-free solders

# NTCG series 0603 type

### SHAPE & DIMENSIONS



Electrode material  
Internal: Pd  
External: Ag/Ni/Sn

Dimensions in mm

### RECOMMENDED LAND PATTERN



### JIS 0603 [EIA 0201]

| Part No.         | Resistance value | Resistance tolerance | B constant    | B constant    | B constant    | B constant     | B constant | Permissible operating current [25°C] (mA) | Operating temperature range (°C) | RT table |
|------------------|------------------|----------------------|---------------|---------------|---------------|----------------|------------|---|----------------------------------|----------|
|                  | [25°C] (Ω)       |                      | [25/50°C] (K) | [25/75°C] (K) | [25/85°C] (K) | [25/100°C] (K) | tolerance  |   |                                  |          |
| NTCG063EH400HTB  | 40               | +/-3%                | 3244          | 3249          | 3250          | 3251           | +/-3%      | 5.00                                      | -40 to 125                       | csv      |
| NTCG063JF103FTB  | 10,000           | +/-1%                | 3380          | 3422          | 3435          | 3453           | +/-1%      | 0.31                                      | -40 to 125                       | csv      |
| NTCG063JF103HTB  | 10,000           | +/-3%                | 3380          | 3422          | 3435          | 3453           | +/-1%      | 0.31                                      | -40 to 125                       | csv      |
| NTCG063JF103JTB  | 10,000           | +/-5%                | 3380          | 3422          | 3435          | 3453           | +/-1%      | 0.31                                      | -40 to 125                       | csv      |
| NTCG063JH103HTB  | 10,000           | +/-3%                | 3380          | 3422          | 3435          | 3453           | +/-3%      | 0.31                                      | -40 to 125                       | csv      |
| NTCG063JH103JTB  | 10,000           | +/-5%                | 3380          | 3422          | 3435          | 3453           | +/-3%      | 0.31                                      | -40 to 125                       | csv      |
| NTCG063UH103HTBX | 10,000           | +/-3%                | 3900          | 3934          | 3950          | 3971           | +/-3%      | 0.31                                      | -40 to 125                       | csv      |
| NTCG064BH103HTB  | 10,000           | +/-3%                | 4067          | 4092          | 4100          | 4110           | +/-3%      | 0.31                                      | -40 to 125                       | csv      |
| NTCG064BH103JTB  | 10,000           | +/-5%                | 4067          | 4092          | 4100          | 4110           | +/-3%      | 0.31                                      | -40 to 125                       | csv      |
| NTCG063JF223HTBX | 22,000           | +/-3%                | 3380          | 3422          | 3435          | 3453           | +/-1%      | 0.21                                      | -40 to 125                       | csv      |
| NTCG064BF473FTBX | 47,000           | +/-1%                | 4050          | 4098          | 4114          | 4137           | +/-1%      | 0.14                                      | -40 to 125                       | csv      |
| NTCG064BF473HTBX | 47,000           | +/-3%                | 4050          | 4098          | 4114          | 4137           | +/-1%      | 0.14                                      | -40 to 125                       | csv      |
| NTCG064BF473JTBX | 47,000           | +/-5%                | 4050          | 4098          | 4114          | 4137           | +/-1%      | 0.14                                      | -40 to 125                       | csv      |
| NTCG064EF683FTBX | 68,000           | +/-1%                | 4250          | 4293          | 4308          | 4327           | +/-1%      | 0.12                                      | -40 to 125                       | csv      |
| NTCG064EF683JTBX | 68,000           | +/-5%                | 4250          | 4293          | 4308          | 4327           | +/-1%      | 0.12                                      | -40 to 125                       | csv      |
| NTCG064BF104FTBX | 100,000          | +/-1%                | 4050          | 4134          | 4114          | 4137           | +/-1%      | 0.10                                      | -40 to 125                       | csv      |
| NTCG064EF104FTBX | 100,000          | +/-1%                | 4250          | 4293          | 4308          | 4327           | +/-1%      | 0.10                                      | -40 to 125                       | csv      |
| NTCG064EF104HTBX | 100,000          | +/-3%                | 4250          | 4293          | 4308          | 4327           | +/-1%      | 0.10                                      | -40 to 125                       | csv      |
| NTCG064EF104JTBX | 100,000          | +/-5%                | 4250          | 4293          | 4308          | 4327           | +/-1%      | 0.10                                      | -40 to 125                       | csv      |
| NTCG064LH104HTB  | 100,000          | +/-3%                | 4485          | 4533          | 4550          | 4573           | +/-3%      | 0.10                                      | -40 to 125                       | csv      |
| NTCG064LH104JTB  | 100,000          | +/-5%                | 4485          | 4533          | 4550          | 4573           | +/-3%      | 0.10                                      | -40 to 125                       | csv      |

⚠ Please be sure to request delivery specifications that provide further details on the features and specifications of the products for proper and safe use.  
Please note that the contents may change without any prior notice due to reasons such as upgrading.



# NTC thermistors

## Commercial grade

Product compatible with RoHS directive  
Compatible with lead-free solders

# NTCG series 1005 type

### SHAPE & DIMENSIONS



Electrode material  
Internal: Pd  
External: Ag/Ni/Sn

Dimensions in mm

### RECOMMENDED LAND PATTERN



### JIS 1005 [EIA 0402] ( 22 to 10kΩ )

| Part No.        | Resistance    |           | B constant<br>[25/50°C]<br>(K) | B constant<br>[25/75°C]<br>(K) | B constant<br>[25/85°C]<br>(K) | B constant<br>[25/100°C]<br>(K) | B constant<br>tolerance | Permissible<br>operating<br>current<br>[25°C]<br>(mA) | Operating<br>temperature<br>range<br>(°C) | RT<br>table<br>range |
|-----------------|---------------|-----------|--------------------------------|--------------------------------|--------------------------------|---------------------------------|-------------------------|---|---|----------------------|
|                 | value         | tolerance |                                |                                |                                |                                 |                         |   |   |                      |
|                 | [25°C]<br>(Ω) |           |                                |                                |                                |                                 |                         |   |   |                      |
| NTCG103EH220JT1 | 22            | +/-5%     | 3244                           | 3249                           | 3250                           | 3251                            | +/-3%                   | 6.70  | -40 to 125                                | csv                  |
| NTCG103EH300JT1 | 30            | +/-5%     | 3244                           | 3249                           | 3250                           | 3251                            | +/-3%                   | 5.70  | -40 to 125                                | csv                  |
| NTCG103EH400HT1 | 40            | +/-3%     | 3244                           | 3249                           | 3250                           | 3251                            | +/-3%                   | 5.00  | -40 to 125                                | csv                  |
| NTCG103EH400JT1 | 40            | +/-5%     | 3244                           | 3249                           | 3250                           | 3251                            | +/-3%                   | 5.00  | -40 to 125                                | csv                  |
| NTCG103EH470JT1 | 47            | +/-5%     | 3244                           | 3249                           | 3250                           | 3251                            | +/-3%                   | 4.61  | -40 to 125                                | csv                  |
| NTCG103EH101HT1 | 100           | +/-3%     | 3244                           | 3249                           | 3250                           | 3251                            | +/-3%                   | 3.10  | -40 to 125                                | csv                  |
| NTCG103EH101JT1 | 100           | +/-5%     | 3244                           | 3249                           | 3250                           | 3251                            | +/-3%                   | 3.10  | -40 to 125                                | csv                  |
| NTCG103NH471JT1 | 470           | +/-5%     | 3642                           | 3649                           | 3650                           | 3650                            | +/-3%                   | 1.40  | -40 to 125                                | csv                  |
| NTCG103NH681JT1 | 680           | +/-5%     | 3642                           | 3649                           | 3650                           | 3650                            | +/-3%                   | 1.20  | -40 to 125                                | csv                  |
| NTCG104BH102HT1 | 1,000         | +/-3%     | 4096                           | 4100                           | 4100                           | 4100                            | +/-3%                   | 1.00  | -40 to 125                                | csv                  |
| NTCG104BH102JT1 | 1,000         | +/-5%     | 4096                           | 4100                           | 4100                           | 4100                            | +/-3%                   | 1.00  | -40 to 125                                | csv                  |
| NTCG104BH152JT1 | 1,500         | +/-5%     | 4096                           | 4100                           | 4100                           | 4100                            | +/-3%                   | 0.81  | -40 to 125                                | csv                  |
| NTCG104BH222JT1 | 2,200         | +/-5%     | 4096                           | 4100                           | 4100                           | 4100                            | +/-3%                   | 0.67  | -40 to 125                                | csv                  |
| NTCG104BH332JT1 | 3,300         | +/-5%     | 4067                           | 4092                           | 4100                           | 4110                            | +/-3%                   | 0.55  | -40 to 125                                | csv                  |
| NTCG103LH472JT1 | 4,700         | +/-5%     | 3500                           | 3532                           | 3545                           | 3564                            | +/-3%                   | 0.46  | -40 to 125                                | csv                  |
| NTCG104BH472HT1 | 4,700         | +/-3%     | 4067                           | 4092                           | 4100                           | 4110                            | +/-3%                   | 0.46  | -40 to 125                                | csv                  |
| NTCG104BH472JT1 | 4,700         | +/-5%     | 4067                           | 4092                           | 4100                           | 4110                            | +/-3%                   | 0.46  | -40 to 125                                | csv                  |
| NTCG104BH682JT1 | 6,800         | +/-5%     | 4067                           | 4092                           | 4100                           | 4110                            | +/-3%                   | 0.38  | -40 to 125                                | csv                  |
| NTCG103JF103FT1 | 10,000        | +/-1%     | 3380                           | 3422                           | 3435                           | 3453                            | +/-1%                   | 0.31  | -40 to 125                                | csv                  |
| NTCG103JF103GT1 | 10,000        | +/-2%     | 3380                           | 3422                           | 3435                           | 3453                            | +/-1%                   | 0.31  | -40 to 125                                | csv                  |
| NTCG103JF103HT1 | 10,000        | +/-3%     | 3380                           | 3422                           | 3435                           | 3453                            | +/-1%                   | 0.31  | -40 to 125                                | csv                  |
| NTCG103JF103JT1 | 10,000        | +/-5%     | 3380                           | 3422                           | 3435                           | 3453                            | +/-1%                   | 0.31  | -40 to 125                                | csv                  |
| NTCG103JH103HT1 | 10,000        | +/-3%     | 3380                           | 3422                           | 3435                           | 3453                            | +/-3%                   | 0.31  | -40 to 125                                | csv                  |
| NTCG103JH103JT1 | 10,000        | +/-5%     | 3380                           | 3422                           | 3435                           | 3453                            | +/-3%                   | 0.31  | -40 to 125                                | csv                  |
| NTCG103JX103DT1 | 10,000        | +/-0.5%   | 3380                           | 3422                           | 3435                           | 3453                            | +/-0.7%                 | 0.31  | -40 to 125                                | csv                  |
| NTCG103UH103HT1 | 10,000        | +/-3%     | 3900                           | 3934                           | 3950                           | 3971                            | +/-3%                   | 0.31  | -40 to 125                                | csv                  |
| NTCG103UH103JT1 | 10,000        | +/-5%     | 3900                           | 3934                           | 3950                           | 3971                            | +/-3%                   | 0.31  | -40 to 125                                | csv                  |
| NTCG104BH103HT1 | 10,000        | +/-3%     | 4067                           | 4092                           | 4100                           | 4110                            | +/-3%                   | 0.31  | -40 to 125                                | csv                  |
| NTCG104BH103JT1 | 10,000        | +/-5%     | 4067                           | 4092                           | 4100                           | 4110                            | +/-3%                   | 0.31  | -40 to 125                                | csv                  |
| NTCG104BH153HT1 | 15,000        | +/-3%     | 4067                           | 4092                           | 4100                           | 4110                            | +/-3%                   | 0.25  | -40 to 125                                | csv                  |
| NTCG104BH153JT1 | 15,000        | +/-5%     | 4067                           | 4092                           | 4100                           | 4110                            | +/-3%                   | 0.25  | -40 to 125                                | csv                  |

⚠ Please be sure to request delivery specifications that provide further details on the features and specifications of the products for proper and safe use.  
Please note that the contents may change without any prior notice due to reasons such as upgrading.

# NTC thermistors

Product compatible with RoHS directive  
Compatible with lead-free solders

## Commercial grade

# NTCG series 1005 type

### SHAPE & DIMENSIONS



Electrode material  
Internal: Pd  
External: Ag/Ni/Sn

Dimensions in mm

### RECOMMENDED LAND PATTERN



### JIS 1005 [EIA 0402] ( 22K to 1,000kΩ )

| Part No.         | Resistance value | Resistance tolerance | B constant    | B constant    | B constant    | B constant     | B constant | Permissible operating current [25°C] (mA) | Operating temperature range (°C) | RT table |
|------------------|------------------|----------------------|---------------|---------------|---------------|----------------|------------|---|----------------------------------|----------|
|                  | [25°C] (Ω)       |                      | [25/50°C] (K) | [25/75°C] (K) | [25/85°C] (K) | [25/100°C] (K) | tolerance  |   |                                  |          |
| NTCG104LH223HT1  | 22,000           | +/-3%                | 4485          | 4533          | 4550          | 4573           | +/-3%      | 0.21                                      | -40 to 125                       | csv      |
| NTCG104LH223JT1  | 22,000           | +/-5%                | 4485          | 4533          | 4550          | 4573           | +/-3%      | 0.21                                      | -40 to 125                       | csv      |
| NTCG104LH333JT1  | 33,000           | +/-5%                | 4485          | 4533          | 4550          | 4573           | +/-3%      | 0.17                                      | -40 to 125                       | csv      |
| NTCG104BF473FT1X | 47,000           | +/-1%                | 4050          | 4098          | 4114          | 4137           | +/-1%      | 0.14                                      | -40 to 125                       | csv      |
| NTCG104BF473HT1X | 47,000           | +/-3%                | 4050          | 4098          | 4114          | 4137           | +/-1%      | 0.14                                      | -40 to 125                       | csv      |
| NTCG104BF473JT1X | 47,000           | +/-5%                | 4050          | 4098          | 4114          | 4137           | +/-1%      | 0.14                                      | -40 to 125                       | csv      |
| NTCG104LH473HT1  | 47,000           | +/-3%                | 4485          | 4533          | 4550          | 4573           | +/-3%      | 0.14                                      | -40 to 125                       | csv      |
| NTCG104LH473JT1  | 47,000           | +/-5%                | 4485          | 4533          | 4550          | 4573           | +/-3%      | 0.14                                      | -40 to 125                       | csv      |
| NTCG104BF683FT1X | 68,000           | +/-1%                | 4085          | 4134          | 4150          | 4172           | +/-1%      | 0.12                                      | -40 to 125                       | csv      |
| NTCG104BF683HT1X | 68,000           | +/-3%                | 4085          | 4134          | 4150          | 4172           | +/-1%      | 0.12                                      | -40 to 125                       | csv      |
| NTCG104BF683JT1X | 68,000           | +/-5%                | 4085          | 4134          | 4150          | 4172           | +/-1%      | 0.12                                      | -40 to 125                       | csv      |
| NTCG104LH683HT1  | 68,000           | +/-3%                | 4485          | 4533          | 4550          | 4573           | +/-3%      | 0.12                                      | -40 to 125                       | csv      |
| NTCG104LH683JT1  | 68,000           | +/-5%                | 4485          | 4533          | 4550          | 4573           | +/-3%      | 0.12                                      | -40 to 125                       | csv      |
| NTCG104ED104DT1X | 100,000          | +/-0.5%              | 4250          | 4293          | 4308          | 4327           | +/-0.5%    | 0.10                                      | -40 to 125                       | csv      |
| NTCG104EF104FT1X | 100,000          | +/-1%                | 4250          | 4293          | 4308          | 4327           | +/-1%      | 0.10                                      | -40 to 125                       | csv      |
| NTCG104EF104HT1X | 100,000          | +/-3%                | 4250          | 4293          | 4308          | 4327           | +/-1%      | 0.10                                      | -40 to 125                       | csv      |
| NTCG104EH104HT1X | 100,000          | +/-3%                | 4250          | 4293          | 4308          | 4327           | +/-3%      | 0.10                                      | -40 to 125                       | csv      |
| NTCG104KF104FT1  | 100,000          | +/-1%                | 4419          | 4468          | 4485          | 4508           | +/-1%      | 0.10                                      | -40 to 125                       | csv      |
| NTCG104KF104HT1  | 100,000          | +/-3%                | 4419          | 4468          | 4485          | 4508           | +/-1%      | 0.10                                      | -40 to 125                       | csv      |
| NTCG104LH104HT1  | 100,000          | +/-3%                | 4485          | 4533          | 4550          | 4573           | +/-3%      | 0.10                                      | -40 to 125                       | csv      |
| NTCG104LH104JT1  | 100,000          | +/-5%                | 4485          | 4533          | 4550          | 4573           | +/-3%      | 0.10                                      | -40 to 125                       | csv      |
| NTCG104LH154JT1  | 150,000          | +/-5%                | 4485          | 4533          | 4550          | 4573           | +/-3%      | 0.08                                      | -40 to 125                       | csv      |
| NTCG104QH224HT1  | 220,000          | +/-3%                | 4661          | 4728          | 4750          | 4780           | +/-3%      | 0.06                                      | -40 to 125                       | csv      |
| NTCG104QH224JT1  | 220,000          | +/-5%                | 4661          | 4728          | 4750          | 4780           | +/-3%      | 0.06                                      | -40 to 125                       | csv      |
| NTCG104QH334HT1  | 330,000          | +/-3%                | 4661          | 4728          | 4750          | 4780           | +/-3%      | 0.05                                      | -40 to 125                       | csv      |
| NTCG104QH334JT1  | 330,000          | +/-5%                | 4661          | 4728          | 4750          | 4780           | +/-3%      | 0.05                                      | -40 to 125                       | csv      |
| NTCG104QH474HT1  | 470,000          | +/-3%                | 4661          | 4728          | 4750          | 4780           | +/-3%      | 0.04                                      | -40 to 125                       | csv      |
| NTCG104QH474JT1  | 470,000          | +/-5%                | 4661          | 4728          | 4750          | 4780           | +/-3%      | 0.04                                      | -40 to 125                       | csv      |
| NTCG104QH105HT1  | 1,000,000        | +/-3%                | 4661          | 4728          | 4750          | 4780           | +/-3%      | 0.03                                      | -40 to 125                       | csv      |
| NTCG104QH105JT1  | 1,000,000        | +/-5%                | 4661          | 4728          | 4750          | 4780           | +/-3%      | 0.03                                      | -40 to 125                       | csv      |

⚠ Please be sure to request delivery specifications that provide further details on the features and specifications of the products for proper and safe use.  
Please note that the contents may change without any prior notice due to reasons such as upgrading.

# NTC thermistors

## Commercial grade

Product compatible with RoHS directive  
Compatible with lead-free solders

# NTCG series 1608 type

## SHAPE & DIMENSIONS



Electrode material  
Internal: Pd  
External: Ag/Ni/Sn

Dimensions in mm

## RECOMMENDED LAND PATTERN



## JIS 1608 [EIA 0603] (30 to 10kΩ)

| Part No.        | Resistance    |           | B constant       |                  |                  |                   |                         | Permissible<br>operating<br>current<br>[25°C]<br>(mA) | Operating<br>temperature<br>range<br>(°C) | RT<br>table<br>range |
|-----------------|---------------|-----------|------------------|------------------|------------------|-------------------|-------------------------|---|---|----------------------|
|                 | value         | tolerance | [25/50°C]<br>(K) | [25/75°C]<br>(K) | [25/85°C]<br>(K) | [25/100°C]<br>(K) | B constant<br>tolerance |   |   |                      |
|                 | [25°C]<br>(Ω) |           |                  |                  |                  |                   |                         |   |   |                      |
| NTCG163EH300JT1 | 30            | +/-5%     | 3244             | 3249             | 3250             | 3251              | +/-3%                   | 5.70  | -40 to 125                                | csv                  |
| NTCG163EH400HT1 | 40            | +/-3%     | 3244             | 3249             | 3250             | 3251              | +/-3%                   | 5.00  | -40 to 125                                | csv                  |
| NTCG163EH400JT1 | 40            | +/-5%     | 3244             | 3249             | 3250             | 3251              | +/-3%                   | 5.00  | -40 to 125                                | csv                  |
| NTCG163EH101HT1 | 100           | +/-3%     | 3244             | 3249             | 3250             | 3251              | +/-3%                   | 3.10  | -40 to 125                                | csv                  |
| NTCG163EH101JT1 | 100           | +/-5%     | 3244             | 3249             | 3250             | 3251              | +/-3%                   | 3.10  | -40 to 125                                | csv                  |
| NTCG163EH151JT1 | 150           | +/-5%     | 3244             | 3249             | 3250             | 3251              | +/-3%                   | 2.50  | -40 to 125                                | csv                  |
| NTCG163NH221JT1 | 220           | +/-5%     | 3642             | 3649             | 3650             | 3650              | +/-3%                   | 2.10  | -40 to 125                                | csv                  |
| NTCG163NH331JT1 | 330           | +/-5%     | 3642             | 3649             | 3650             | 3650              | +/-3%                   | 1.70  | -40 to 125                                | csv                  |
| NTCG163NH471JT1 | 470           | +/-5%     | 3642             | 3649             | 3650             | 3650              | +/-3%                   | 1.40  | -40 to 125                                | csv                  |
| NTCG164BH102HT1 | 1,000         | +/-3%     | 4096             | 4100             | 4100             | 4100              | +/-3%                   | 1.00  | -40 to 125                                | csv                  |
| NTCG164BH102JT1 | 1,000         | +/-5%     | 4096             | 4100             | 4100             | 4100              | +/-3%                   | 1.00  | -40 to 125                                | csv                  |
| NTCG164BH222JT1 | 2,200         | +/-5%     | 4096             | 4100             | 4100             | 4100              | +/-3%                   | 0.67  | -40 to 125                                | csv                  |
| NTCG164BH302JT1 | 3,000         | +/-5%     | 4067             | 4100             | 4100             | 4110              | +/-3%                   | 0.57  | -40 to 125                                | csv                  |
| NTCG164BH332HT1 | 3,300         | +/-3%     | 4067             | 4092             | 4100             | 4110              | +/-3%                   | 0.55  | -40 to 125                                | csv                  |
| NTCG164BH332JT1 | 3,300         | +/-5%     | 4067             | 4092             | 4100             | 4110              | +/-3%                   | 0.55  | -40 to 125                                | csv                  |
| NTCG164BH472HT1 | 4,700         | +/-3%     | 4067             | 4092             | 4100             | 4110              | +/-3%                   | 0.46  | -40 to 125                                | csv                  |
| NTCG164BH472JT1 | 4,700         | +/-5%     | 4067             | 4092             | 4100             | 4110              | +/-3%                   | 0.46  | -40 to 125                                | csv                  |
| NTCG164BH682JT1 | 6,800         | +/-5%     | 4067             | 4092             | 4100             | 4110              | +/-3%                   | 0.38  | -40 to 125                                | csv                  |
| NTCG163JF103FT1 | 10,000        | +/-1%     | 3380             | 3422             | 3435             | 3453              | +/-1%                   | 0.31  | -40 to 125                                | csv                  |
| NTCG163JF103HT1 | 10,000        | +/-3%     | 3380             | 3422             | 3435             | 3453              | +/-1%                   | 0.31  | -40 to 125                                | csv                  |
| NTCG163JH103HT1 | 10,000        | +/-3%     | 3380             | 3422             | 3435             | 3453              | +/-3%                   | 0.31  | -40 to 125                                | csv                  |
| NTCG163JH103JT1 | 10,000        | +/-5%     | 3380             | 3422             | 3435             | 3453              | +/-3%                   | 0.31  | -40 to 125                                | csv                  |
| NTCG164BF103HT1 | 10,000        | +/-3%     | 4037             | 4092             | 4070             | 4080              | +/-1%                   | 0.31  | -40 to 125                                | csv                  |
| NTCG164BH103HT1 | 10,000        | +/-3%     | 4067             | 4092             | 4100             | 4110              | +/-3%                   | 0.31  | -40 to 125                                | csv                  |
| NTCG164BH103JT1 | 10,000        | +/-5%     | 4067             | 4092             | 4100             | 4110              | +/-3%                   | 0.31  | -40 to 125                                | csv                  |

⚠ Please be sure to request delivery specifications that provide further details on the features and specifications of the products for proper and safe use.  
Please note that the contents may change without any prior notice due to reasons such as upgrading.

# NTC thermistors

## Commercial grade

Product compatible with RoHS directive  
Compatible with lead-free solders

# NTCG series 1608 type

## SHAPE & DIMENSIONS

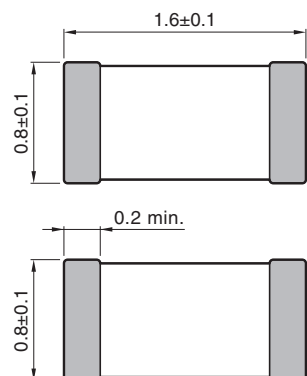

Electrode material  
Internal: Pd  
External: Ag/Ni/Sn

Dimensions in mm

## RECOMMENDED LAND PATTERN



## JIS 1608 [EIA 0603] ( 22k to 1,000kΩ )

| Part No.        | Resistance value | Resistance tolerance | B constant    | B constant    | B constant    | B constant     | B constant | Permissible operating current [25°C] (mA) | Operating temperature range (°C) | RT table |
|-----------------|------------------|----------------------|---------------|---------------|---------------|----------------|------------|---|----------------------------------|----------|
|                 | [25°C] (Ω)       |                      | [25/50°C] (K) | [25/75°C] (K) | [25/85°C] (K) | [25/100°C] (K) | tolerance  |   |                                  |          |
| NTCG164BH153JT1 | 15,000           | +/-5%                | 4067          | 4092          | 4100          | 4110           | +/-3%      | 0.25                                      | -40 to 125                       | csv      |
| NTCG164LH223HT1 | 22,000           | +/-3%                | 4485          | 4533          | 4550          | 4573           | +/-3%      | 0.21                                      | -40 to 125                       | csv      |
| NTCG164LH223JT1 | 22,000           | +/-5%                | 4485          | 4533          | 4550          | 4573           | +/-3%      | 0.21                                      | -40 to 125                       | csv      |
| NTCG164LH333JT1 | 33,000           | +/-5%                | 4485          | 4533          | 4550          | 4573           | +/-3%      | 0.17                                      | -40 to 125                       | csv      |
| NTCG164LH473HT1 | 47,000           | +/-3%                | 4485          | 4533          | 4550          | 4573           | +/-3%      | 0.14                                      | -40 to 125                       | csv      |
| NTCG164LH473JT1 | 47,000           | +/-5%                | 4485          | 4533          | 4550          | 4573           | +/-3%      | 0.14                                      | -40 to 125                       | csv      |
| NTCG164LH683HT1 | 68,000           | +/-3%                | 4485          | 4533          | 4550          | 4573           | +/-3%      | 0.12                                      | -40 to 125                       | csv      |
| NTCG164LH683JT1 | 68,000           | +/-5%                | 4485          | 4533          | 4550          | 4573           | +/-3%      | 0.12                                      | -40 to 125                       | csv      |
| NTCG164KF104FT1 | 100,000          | +/-1%                | 4419          | 4468          | 4485          | 4508           | +/-1%      | 0.10                                      | -40 to 125                       | csv      |
| NTCG164LH104HT1 | 100,000          | +/-3%                | 4485          | 4533          | 4550          | 4573           | +/-3%      | 0.10                                      | -40 to 125                       | csv      |
| NTCG164LH104JT1 | 100,000          | +/-5%                | 4485          | 4533          | 4550          | 4573           | +/-3%      | 0.10                                      | -40 to 125                       | csv      |
| NTCG164LH154HT1 | 150,000          | +/-3%                | 4485          | 4533          | 4550          | 4573           | +/-3%      | 0.08                                      | -40 to 125                       | csv      |
| NTCG164LH154JT1 | 150,000          | +/-5%                | 4485          | 4533          | 4550          | 4573           | +/-3%      | 0.08                                      | -40 to 125                       | csv      |
| NTCG164QH224HT1 | 220,000          | +/-3%                | 4661          | 4728          | 4750          | 4780           | +/-3%      | 0.06                                      | -40 to 125                       | csv      |
| NTCG164QH224JT1 | 220,000          | +/-5%                | 4661          | 4728          | 4750          | 4780           | +/-3%      | 0.06                                      | -40 to 125                       | csv      |
| NTCG164QH334JT1 | 330,000          | +/-5%                | 4661          | 4728          | 4750          | 4780           | +/-3%      | 0.05                                      | -40 to 125                       | csv      |
| NTCG164QH474HT1 | 470,000          | +/-3%                | 4661          | 4728          | 4750          | 4780           | +/-3%      | 0.04                                      | -40 to 125                       | csv      |
| NTCG164QH474JT1 | 470,000          | +/-5%                | 4661          | 4728          | 4750          | 4780           | +/-3%      | 0.04                                      | -40 to 125                       | csv      |
| NTCG164QH105HT1 | 1,000,000        | +/-3%                | 4661          | 4728          | 4750          | 4780           | +/-3%      | 0.03                                      | -40 to 125                       | csv      |
| NTCG164QH105JT1 | 1,000,000        | +/-5%                | 4661          | 4728          | 4750          | 4780           | +/-3%      | 0.03                                      | -40 to 125                       | csv      |

⚠ Please be sure to request delivery specifications that provide further details on the features and specifications of the products for proper and safe use.  
Please note that the contents may change without any prior notice due to reasons such as upgrading.

# NTC thermistors

## Commercial grade

Product compatible with RoHS directive  
Compatible with lead-free solders

# NTCG series 2012 type

## SHAPE & DIMENSIONS



Electrode material  
Internal: Pd  
External: Ag/Ni/Sn

Dimensions in mm

## RECOMMENDED LAND PATTERN



## JIS 2012 [EIA 0805]

| Part No.        | Resistance value | Resistance tolerance | B constant    | B constant    | B constant    | B constant     | B constant tolerance | Permissible operating current [25°C] (mA) | Operating temperature range (°C) | RT table |
|-----------------|------------------|----------------------|---------------|---------------|---------------|----------------|----------------------|---|----------------------------------|----------|
|                 | [25°C] (Ω)       |                      | [25/50°C] (K) | [25/75°C] (K) | [25/85°C] (K) | [25/100°C] (K) |                      |   |                                  |          |
| NTCG203EH471JT1 | 470              | +/-5%                | 3232          | 3246          | 3250          | 3255           | +/-3%                | 2.00                                      | -40 to 125                       | csv      |
| NTCG203EH681JT1 | 680              | +/-5%                | 3232          | 3246          | 3250          | 3255           | +/-3%                | 1.70                                      | -40 to 125                       | csv      |
| NTCG203BH102JT1 | 1,000            | +/-5%                | 3060          | 3089          | 3100          | 3113           | +/-3%                | 1.40                                      | -40 to 125                       | csv      |
| NTCG203BH152JT1 | 1,500            | +/-5%                | 3060          | 3089          | 3100          | 3113           | +/-3%                | 1.10                                      | -40 to 125                       | csv      |
| NTCG203FH222JT1 | 2,200            | +/-5%                | 3248          | 3287          | 3300          | 3318           | +/-3%                | 0.95                                      | -40 to 125                       | csv      |
| NTCG203FH332JT1 | 3,300            | +/-5%                | 3248          | 3287          | 3300          | 3318           | +/-3%                | 0.77                                      | -40 to 125                       | csv      |
| NTCG203JH472JT1 | 4,700            | +/-5%                | 3392          | 3436          | 3450          | 3468           | +/-3%                | 0.65                                      | -40 to 125                       | csv      |
| NTCG203JH682JT1 | 6,800            | +/-5%                | 3392          | 3436          | 3450          | 3468           | +/-3%                | 0.54                                      | -40 to 125                       | csv      |
| NTCG203NH103JT1 | 10,000           | +/-5%                | 3590          | 3635          | 3650          | 3670           | +/-3%                | 0.44                                      | -40 to 125                       | csv      |
| NTCG203NH153JT1 | 15,000           | +/-5%                | 3590          | 3635          | 3650          | 3670           | +/-3%                | 0.36                                      | -40 to 125                       | csv      |
| NTCG203SH223JT1 | 22,000           | +/-5%                | 3782          | 3832          | 3850          | 3874           | +/-3%                | 0.30                                      | -40 to 125                       | csv      |
| NTCG203SH333JT1 | 33,000           | +/-5%                | 3782          | 3832          | 3850          | 3874           | +/-3%                | 0.24                                      | -40 to 125                       | csv      |
| NTCG204AH473JT1 | 47,000           | +/-5%                | 3931          | 3982          | 4000          | 4023           | +/-3%                | 0.20                                      | -40 to 125                       | csv      |
| NTCG204AH683JT1 | 68,000           | +/-5%                | 3931          | 3982          | 4000          | 4023           | +/-3%                | 0.17                                      | -40 to 125                       | csv      |
| NTCG204CH104JT1 | 100,000          | +/-5%                | 4085          | 4134          | 4150          | 4172           | +/-3%                | 0.14                                      | -40 to 125                       | csv      |
| NTCG204CH154JT1 | 150,000          | +/-5%                | 4085          | 4134          | 4150          | 4172           | +/-3%                | 0.11                                      | -40 to 125                       | csv      |

 Please be sure to request delivery specifications that provide further details on the features and specifications of the products for proper and safe use.  
Please note that the contents may change without any prior notice due to reasons such as upgrading.

# NTC thermistors

## Commercial grade

Product compatible with RoHS directive  
Compatible with lead-free solders

# NTCG series RT table

### R-T TABLE ACQUISITION PROCEDURE

1. Access the top page of the TDK chip NTC thermistor (protective device)  
<https://product.tdk.com/info/en/products/protection/temperature/chip-ntc-thermistor/index.html>

2. Click [Search by Part No.]  
[https://product.tdk.com/en/search/protection/temperature/chip-ntc-thermistor/part\\_no/](https://product.tdk.com/en/search/protection/temperature/chip-ntc-thermistor/part_no/)

3. Enter the product name you want in the RT table in the box and click the Search button.  
( Example: NTCG103JF103FT1 )



#### Wildcard and Multiple Part number.

- Question mark (?) and asterisk (\*) can be used as wildcard characters. The question mark (?) matches any single character, and the asterisk (\*) matches any sequence of characters.
- Enter only one part number per line. Up to 50 part numbers can be searched simultaneously.
- A part number search is normally performed using a prefix search. If you wish to use a suffix search, enter an exclamation mark (!) at the end of the Part No.

4. Click the displayed product name.  
( Example: NTCG103JF103FT1 )

| Check                    | Catalog / Data Sheet ?  | Images  | Part No. ?  | Distributor Inventory   | Brand | Apps.   | Feature           |
|--------------------------|---|---|---|-------------------------|-------|---|-------------------|
| <input type="checkbox"/> |   |   |   |                         |       |   |                   |
| <input type="checkbox"/> |  |  | <br>NTCG103JF103FT1  | <a href="#">Buy Now</a> | TDK   |  | 125°C<br>UL       |
| <input type="checkbox"/> |  |  | <br>NTCG103JF103FT1S | <a href="#">Buy Now</a> | TDK   |  | 150°C<br>AEC-Q200 |

5. Individual pages are displayed and click the RT table in the "Document" on the right side bar.

| Documents  |
|--|
|  Catalog                |
|  RoHS Certificate       |
|  SVHC/REACH Certificate |
|  Selection Guide        |
|  RT Sheet               |

6. You can download the csv file in the 1°C step of the RT table for the product.

 Please be sure to request delivery specifications that provide further details on the features and specifications of the products for proper and safe use. Please note that the contents may change without any prior notice due to reasons such as upgrading.

# NTC thermistors

## Commercial grade

Product compatible with RoHS directive  
Compatible with lead-free solders

# Attention in the board design

### BOARD DESIGN

When attached to NTC substrate thermistor, amount of silver used (fillet size) has direct impact on NTC thermistor after mounting. Thus, sufficient consideration is necessary.

#### Set of land dimensions

(1) As the stress rises in the NTC thermistor owing to the increase in silver, breakage and cracks will occur. Cause including crack, as caution on board land design, configure the shape and dimensions so that the amount of silver is appropriate.

If you installed 2 or more parts in the Common Land, separated by a solder resist and special land of each component.

Dimensions shape



| Shape symbol | Symbol       |              |              |
|--------------|--------------|--------------|--------------|
|              | A            | B            | C            |
| 0603         | 0.25 to 0.35 | 0.20 to 0.30 | 0.25 to 0.35 |
| 1005         | 0.30 to 0.50 | 0.35 to 0.45 | 0.40 to 0.60 |
| 1608         | 0.60 to 0.80 | 0.60 to 0.80 | 0.60 to 0.80 |
| 2012         | 0.90 to 1.20 | 0.70 to 0.90 | 0.90 to 1.20 |

(2) When peak levels panning-at soldering is excessive, by solder contraction stress, mechanical-thermal stress causes a Yasuku chip crack.

In addition, when the peak level is underestimated, terminal electrode fixed strength is insufficient. This causes chip dropouts and may affect circuit reliability.

Representative example of the panning of peak levels is shown in the following.

#### Recommended silver dose

|                        |  |   |
|------------------------|--|---|
| Solder volume overload |  | Solder stress is increased, and it is easy for a crack to form.             |
| Decent solder volume   |  |   |
| Solder volume deficit  |  | Fixed strength is weak, and there is connection a problem and risk of loss. |

#### Case and suggested protocol want to avoid

| Example  | Cases to avoid | Improvement example (land division) |
|--|----------------|-------------------------------------|
| Lead wire and land of part discrete doubles up |                |                                     |
| Arrangements in the vicinity                   |                |                                     |
| Arrangements of chip component's companion     |                |                                     |

⚠ Please be sure to request delivery specifications that provide further details on the features and specifications of the products for proper and safe use. Please note that the contents may change without any prior notice due to reasons such as upgrading.

# NTC thermistors

## Commercial grade

Product compatible with RoHS directive  
Compatible with lead-free solders

# Attention in the board design

### Arrangements of components

(1) I was based on camber of substrate and suggested protocol of NTC thermistor arrangement, as stress does not join to the utmost is shown in following.



(2) In payment near by board, depending on mount position of NTC PTC, as mechanical stress varies, please refer to the following diagram.



The order of A > B = C > D > E eases the stress.

⚠ Please be sure to request delivery specifications that provide further details on the features and specifications of the products for proper and safe use. Please note that the contents may change without any prior notice due to reasons such as upgrading.



# NTC thermistors

## Commercial grade

Product compatible with RoHS directive  
Compatible with lead-free solders

# Attention on the mounting

## APPLICATION TO BOARD

### Mounting head pressure

Under suction nozzle if dead point too, during implementation, excessive force joins of NTC thermistor low, as cause causes of crack, please use with reference to something about following.

- 1) Being set to top surface of substrate so that under suction nozzle as for dead center, substrate does not bend back, and adjust, please.
- 2) Nozzle pressure at implementation is 0.1 to 0.3 N in static load, please.
- 3) Substrate fixes up back surface of substrate with support pin in impact of suction nozzle to wely deflection to the utmost, and substrate hold deflection, please.

A representative example is shown in the following.



Mechanical shock that, if positioning your nail to wear, ragged edge of positionings, participates in NTC thermistor are locally, and NTC thermistor, as there is possibility of crack generated, cut the closed positioning, and maintenance and inspection, and, exchange of manage dimensions and position nail periodically, please.

## SOLDERING

Significant impact is possible on the performance of NTC thermistor, flux checks something about follow, please use.

- (1) Flux uses one with 0.1wt % (Cl conversion) or less halide substance contains amounts, please. In addition, do not do this with strongly acidic objects.
- (2) Flux during is soldered (2) NTC substrate thermistor is applied the smallest amount necessary, please.
- (3) If Used soluble flux, perform thorough wash particularly, please.

### Reflow temperature profile



| Item   | Specification               |                      |
|--|-----------------------------|----------------------|
|  | for eutectic mixture solder | For lead-free solder |
| Preheating temperature                                   | 160 to 180°C                | 150 to 180°C         |
| Solder melting temperature                               | 200°C                       | 230°C                |
| Maximum temperature                                      | 240°C max.                  | 260°C max.           |
| Preheating time  | 100s max.                   | 120s max.            |
| Time to reach higher than the solder melting temperature | 30s max.                    | 40s max.             |
| number of possible reflow cycles                         | 2 max.                      | 2 max.               |

## SOLDERING IRON

(1) The tip temperature and also by (1) types of soldering irons, the size of the substrate, and the geometry of the land pattern. Being earlier, but when as there is possibility that crack occurs in the heat anderson impaction, point soldering iron temperature is high, please do solder work within the following conditions.

| Temperature of iron tips (°C) | Wattage (W) | Pallet point shape (mm) | Soldering time (Second) | Frequency   |
|-------------------------------|-------------|-------------------------|-------------------------|---|
| 350max.                       | 20max.      | ø3.0max.                | 5 max.                  | Within each terminal once (Within total of twice) |

(2) Direct iron tip is in contact with the (2) NTC thermistor body, and the strain owing to thermal shock in particular grows even if a crack is generated. Therefore, please do not touch it directly to the terminal electrodes.

# NTC thermistors

## Commercial grade

Product compatible with RoHS directive  
Compatible with lead-free solders

# Attention after mounting

## CLEANING

- (1) If cleaning liquid is inappropriate, residues and other foreign body of fluxes builds up on NTC PTC surface, and can degrade the performance of NTC thermistor (particularly the insulation resistance).
- (2) Wash conditions may compromise performance of NTC thermistor if they are improper (wash due, wash excess).

### 2-1) For wash due

- (a) By substance of a system in flux residue halide, metal including terminal electrodes may experience corrosion.
- (b) Substance of a system in flux residue halide builds up on NTC PTC surface, and reduces the insulation resistance.
- (c) Soluble flux makes comparisons of colophony series flux, and there is event with trends of significant (1) and (2).

### 2-2) For excess wash

- (1) Owing to lavage, NTC PTC surface deteriorates, and reduces performance of NTC thermistor.
- (2) In ultrasonography, when output is passed, substrate resonates size, and crack occurs in body and sprang of NTC thermistor in vibration of substrate. Since this may reduce the strength of the terminal electrode, please note the following conditions.
- Output    Ultrasound output  
Frequency    Ultrasonic frequency  
Cleaning time    Ultrasound cleaning time

2-3) Concentration including halogen that when cleaning liquid to pollution, when you released is higher, and may cause similar of results into wash due.

## SUBSTRATE HANDLING AFTER COMPONENT MOUNTING

(1) When substrate is divided, a flexible so that show in following diagram to substrate, and is given by stress including twist, as there is possibility that crack occurs of NTC thermistor, please check that stress is within acceptable limits.

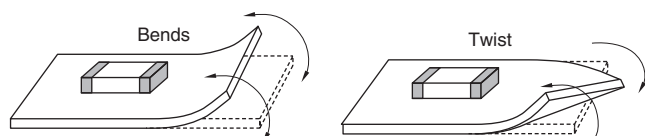

(2) During each substrate operational check, push pressure with contact failure of check pin of boards checkers of check pin may be toned up to be prevented. As substrate is bent under loading, NTC thermistor is broken owing to stress. There is also the possibility that solder on the terminal electrode will peel off. Follow the diagram for reference, and check that the substrate bends, please.

| Item           | Cases to avoid | Recommended case |
|----------------|----------------|------------------|
| Substrate sags |                |                  |

## SINGLE-PART COMPONENT HANDLING

(1) To drop impact, as there is possibility that breakage and crack is entered, do not NTC thermistor that (1) NTC thermistor falls.

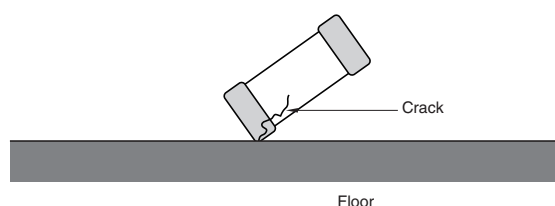

(2) At stacking storage after implementation and treatment of substrate, corner of boards is regarded as NTC thermistor. Please be careful, as there is the possibility that breakage and cracks will occur on impact.

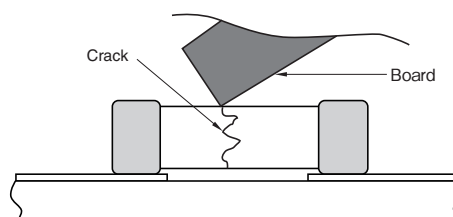

# NTC thermistors

## Commercial grade

Product compatible with RoHS directive  
Compatible with lead-free solders

# Packaging style

### REEL DIMENSIONS

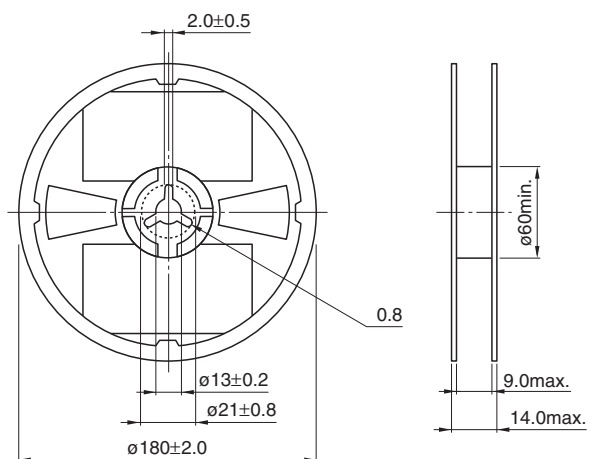

Dimensions in mm

### TAPE DIMENSIONS

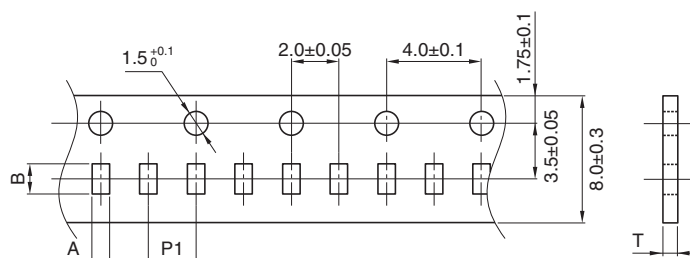

Dimensions in mm

| Type | A              | B              | P1      | T        |
|------|----------------|----------------|---------|----------|
| 0603 | 0.38±0.05      | 0.68±0.05      | 2±0.05  | 0.45max. |
| 1005 | 0.65+0.05/-0.1 | 1.15+0.05/-0.1 | 2±0.05  | 0.65max. |
| 1608 | 1.1±0.2        | 1.9±0.2        | 4.0±0.1 | 1.1max.  |
| 2012 | 1.6±0.2        | 2.3±0.2        | 4.0±0.1 | 1.1max.  |

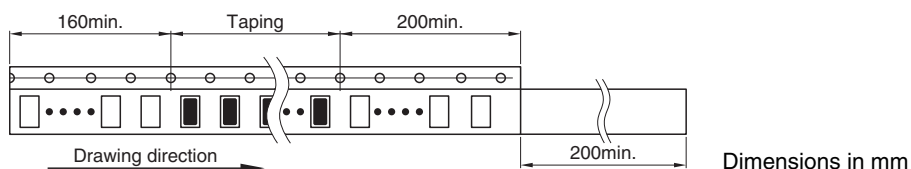

Dimensions in mm

Please be sure to request delivery specifications that provide further details on the features and specifications of the products for proper and safe use.  
Please note that the contents may change without any prior notice due to reasons such as upgrading.

# NTC thermistors

## Commercial grade

Product compatible with RoHS directive  
Compatible with lead-free solders

# Description and definition of terms

### INITIAL RESISTANCE

Thermistor resistance is a function of absolute temperature as indicated by the following relationship:

$$R=R_0 \cdot \exp B \left( \frac{1}{T} - \frac{1}{T_0} \right) \dots\dots\dots (1)$$

Here R<sub>0</sub>, R(kΩ) are the respective resistance values when the surrounding temperature is T<sub>0</sub>, T(K). B is the thermistor constant(B constant below).

### B CONSTANT

The B constant is found from the following equation:

$$B= \frac{2.3026(\log R - \log R_0)}{\frac{1}{T} - \frac{1}{T_0}} \dots\dots\dots (2)$$

This B characteristic is indicated by the slope of the linear plot of log R-1/T inverse absolute temperature. The B constant value is generally in the vicinity of 2500K to 5000K. B constant values of 3000K to 4000K are frequently used for measurements.

Resistance-temperature characteristics (Fig.1)

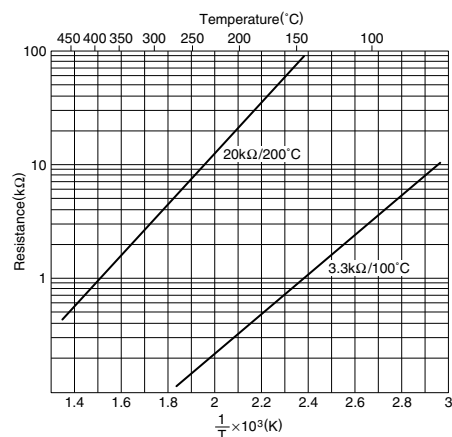

### TEMPERATURE COEFFICIENT

The relationship between temperature coefficient α and B becomes:

$$\alpha = \frac{1}{R} \cdot \frac{dR}{dT} = - \frac{B}{T^2} \times 100(\%/^{\circ}C) \dots\dots\dots (3)$$

The negative sign of the temperature coefficient indicates that the temperature coefficient decreases as both thermistor resistance and temperature rise. If B is taken as 3400K, the temperature coefficient found at 20°C (293.15K) becomes -4%/°C.

 Please be sure to request delivery specifications that provide further details on the features and specifications of the products for proper and safe use. Please note that the contents may change without any prior notice due to reasons such as upgrading.

**HEAT DISSIPATION COEFFICIENT**

Temperature rises due to thermal energy formed as electrical current flows through the thermistor. The thermistor temperature  $T_0$  is then related to the surrounding temperature  $T_a$  and the electrical input  $W$ :

$$W = k(T_0 - T_a) = V \cdot I \text{ (mW)} \quad (4)$$

$$k = \frac{W}{T_0 - T_a} \text{ (mW/}^\circ\text{C)} \quad (5)$$

This  $k$  value is the heat dissipation coefficient, which represents the additional electrical power (mW/°C) needed to raise the thermistor temperature by 1°C. This heat dissipation coefficient varies with changes in the measurement and environmental conditions. When a thermistor is used for temperature measurement, it is naturally important to lower the applied electrical current as much as possible in order to reduce measurement error resulting from self heating.

**VOLTAGE - CURRENT CHARACTERISTIC**

The voltage - current characteristic indicates the drop in voltage as electrical current through the thermistor is gradually increased.

**Voltage-current characteristics (Fig.2)**



**HEATING TIME CONSTANT**

The time period required to heat up a thermistor from a certain temperature  $T_0$  over a target temperature rise is called the heating time constant. Various types of heating time constants are indicated by the symbols shown in Table 1 as determined by the percent change from  $T_0$  toward the target temperature. The standard change is typically taken to be 63.2%.

**Thermal time constants (Fig.3)**



**Table 1 Heating time constant and temperature change ratio**

| Code    | Rate of change (%) for $T_0 - T_a$ |
|---------|------------------------------------|
| $\tau$  | 63.2                               |
| $2\tau$ | 86.5                               |
| $3\tau$ | 95.0                               |
| $4\tau$ | 98.2                               |
| $5\tau$ | 99.4                               |
| $6\tau$ | 99.8                               |
| $7\tau$ | 99.9                               |

**PERMISSIBLE OPERATING CURRENT**

This is the maximum load current limit below 1°C temperature rise due to thermistor self-heating. It's possible to express it in the following system.

$$\text{Maximum allowed current [mA]} = \sqrt{\text{Heat dissipation constant [mW/}^\circ\text{C]} \div \text{Resistance [}\Omega\text{]}}$$

Please be sure to request delivery specifications that provide further details on the features and specifications of the products for proper and safe use. Please note that the contents may change without any prior notice due to reasons such as upgrading.

Компания «Океан Электроники» предлагает заключение долгосрочных отношений при поставках импортных электронных компонентов на взаимовыгодных условиях!

Наши преимущества:

- Поставка оригинальных импортных электронных компонентов напрямую с производств Америки, Европы и Азии, а так же с крупнейших складов мира;
- Широкая линейка поставок активных и пассивных импортных электронных компонентов (более 30 млн. наименований);
- Поставка сложных, дефицитных, либо снятых с производства позиций;
- Оперативные сроки поставки под заказ (от 5 рабочих дней);
- Экспресс доставка в любую точку России;
- Помощь Конструкторского Отдела и консультации квалифицированных инженеров;
- Техническая поддержка проекта, помощь в подборе аналогов, поставка прототипов;
- Поставка электронных компонентов под контролем ВП;
- Система менеджмента качества сертифицирована по Международному стандарту ISO 9001;
- При необходимости вся продукция военного и аэрокосмического назначения проходит испытания и сертификацию в лаборатории (по согласованию с заказчиком);
- Поставка специализированных компонентов военного и аэрокосмического уровня качества (Xilinx, Altera, Analog Devices, Intersil, Interpoint, Microsemi, Actel, Aeroflex, Peregrine, VPT, Syfer, Eurofarad, Texas Instruments, MS Kennedy, Miteq, Cobham, E2V, MA-COM, Hittite, Mini-Circuits, General Dynamics и др.);

Компания «Океан Электроники» является официальным дистрибьютором и эксклюзивным представителем в России одного из крупнейших производителей разъемов военного и аэрокосмического назначения «JONHON», а так же официальным дистрибьютором и эксклюзивным представителем в России производителя высокотехнологичных и надежных решений для передачи СВЧ сигналов «FORSTAR».



## JONHON

«JONHON» (основан в 1970 г.)

Разъемы специального, военного и аэрокосмического назначения:

(Применяются в военной, авиационной, аэрокосмической, морской, железнодорожной, горно- и нефтедобывающей отраслях промышленности)

«FORSTAR» (основан в 1998 г.)

ВЧ соединители, коаксиальные кабели,  
кабельные сборки и микроволновые компоненты:

(Применяются в телекоммуникациях гражданского и специального назначения, в средствах связи, РЛС, а так же военной, авиационной и аэрокосмической отраслях промышленности).



Телефон: 8 (812) 309-75-97 (многоканальный)

Факс: 8 (812) 320-03-32

Электронная почта: [ocean@oceanchips.ru](mailto:ocean@oceanchips.ru)

Web: <http://oceanchips.ru/>

Адрес: 198099, г. Санкт-Петербург, ул. Калинина, д. 2, корп. 4, лит. А