



Thyristor/Diode and Thyristor/Thyristor (SUPER MAGN-A-PAK Power Modules), 500 A



SUPER MAGN-A-PAK

FEATURES

- High current capability
- High surge capability
- Industrial standard package
- 3000 V_{RMS} isolating voltage with non-toxic substrate
- UL approved file E78996 
- Compliant to RoHS directive 2002/95/EC
- Designed and qualified for industrial level



RoHS COMPLIANT

PRODUCT SUMMARY

I_{T(AV)}, I_{F(AV)}

500 A

MAJOR RATINGS AND CHARACTERISTICS

SYMBOL	CHARACTERISTICS	VALUES	UNITS
I _{T(AV)} , I _{F(AV)}	82 °C	500	A
I _{T(RMS)}		785	A
	T _C	82	°C
I _{TSM}	50 Hz	17.8	kA
	60 Hz	18.7	
I ² t	50 Hz	1591	kA ² s
	60 Hz	1452	
I ² √t		15 910	kA ² √s
V _{RRM}	Range	800 to 1600	V
T _{Stg}	Range	- 40 to 150	°C
T _J	Range	- 40 to 130	

ELECTRICAL SPECIFICATIONS

VOLTAGE RATINGS

TYPE NUMBER	VOLTAGE CODE	V _{RRM} /V _{DRM} , MAXIMUM REPETITIVE PEAK REVERSE VOLTAGE V	V _{RSM} , MAXIMUM NON-REPETITIVE PEAK REVERSE VOLTAGE V	I _{RRM} /I _{DRM} MAXIMUM AT T _J = T _J MAXIMUM mA
VSK.500	08	800	900	100
	12	1200	1300	
	14	1400	1500	
	16	1600	1700	

ON-STATE CONDUCTION					
PARAMETER	SYMBOL	TEST CONDITIONS		VALUES	UNITS
Maximum average on-state current at case temperature	$I_{T(AV)}$, $I_{F(AV)}$	180° conduction, half sine wave		500	A
				82	°C
Maximum RMS on-state current	$I_{T(RMS)}$	180° conduction, half sine wave at $T_C = 82\text{ °C}$		785	A
Maximum peak, one-cycle, non-repetitive on-state surge current	I_{TSM} , I_{FSM}	t = 10 ms	No voltage reappplied	Sinusoidal half wave, initial $T_J = T_J$ maximum	kA
		t = 8.3 ms			
		t = 10 ms	100 % V_{RRM} reappplied		
		t = 8.3 ms			
Maximum I^2t for fusing	I^2t	t = 10 ms	No voltage reappplied		kA ² s
		t = 8.3 ms			
		t = 10 ms	100 % V_{RRM} reappplied		
		t = 8.3 ms			
Maximum $I^2\sqrt{t}$ for fusing	$I^2\sqrt{t}$	t = 0.1 ms to 10 ms, no voltage reappplied		15 910	kA ² √s
Low level value or threshold voltage	$V_{T(TO)1}$	(16.7 % $\times \pi \times I_{T(AV)} < I < \pi \times I_{T(AV)}$, $T_J = T_J$ maximum)		0.85	V
High level value of threshold voltage	$V_{T(TO)2}$	(I $> \pi \times I_{T(AV)}$, $T_J = T_J$ maximum)		0.93	
Low level value on-state slope resistance	r_{t1}	(16.7 % $\times \pi \times I_{T(AV)} < I < \pi \times I_{T(AV)}$, $T_J = T_J$ maximum)		0.36	mΩ
High level value on-state slope resistance	r_{t2}	(I $> \pi \times I_{T(AV)}$, $T_J = T_J$ maximum)		0.32	
Maximum on-state voltage drop	V_{TM}	$I_{pk} = 1500\text{ A}$, $T_J = 25\text{ °C}$, $t_p = 10\text{ ms}$ sine pulse		1.50	V
Maximum forward voltage drop	V_{FM}	$I_{pk} = 1500\text{ A}$, $T_J = 25\text{ °C}$, $t_p = 10\text{ ms}$ sine pulse		1.50	V
Maximum holding current	I_H	$T_J = 25\text{ °C}$, anode supply 12 V resistive load		500	mA
Maximum latching current	I_L			1000	

SWITCHING					
PARAMETER	SYMBOL	TEST CONDITIONS		VALUES	UNITS
Maximum rate of rise of turned-on current	di/dt	$T_J = T_J$ maximum, $I_{TM} = 400\text{ A}$, V_{DRM} applied		1000	A/μs
Typical delay time	t_d	Gate current 1 A, $di_g/dt = 1\text{ A}/\mu\text{s}$ $V_d = 0.67\% V_{DRM}$, $T_J = 25\text{ °C}$		2.0	μs
Typical turn-off time	t_q	$I_{TM} = 750\text{ A}$; $T_J = T_J$ maximum, $di/dt = -60\text{ A}/\mu\text{s}$, $V_R = 50\text{ V}$, $dV/dt = 20\text{ V}/\mu\text{s}$, gate 0 V 100 Ω		200	

BLOCKING					
PARAMETER	SYMBOL	TEST CONDITIONS		VALUES	UNITS
Maximum critical rate of rise of off-state voltage	dV/dt	$T_J = 130\text{ °C}$, linear to $V_D = 80\% V_{DRM}$		1000	V/μs
RMS insulation voltage	V_{INS}	t = 1 s		3000	V
Maximum peak reverse and off-state leakage current	I_{RRM} , I_{DRM}	$T_J = T_J$ maximum, rated V_{DRM}/V_{RRM} applied		100	mA



VSKT500-..PbF, VSKH500-..PbF, VSKL500-..PbF

Thyristor/Diode and Thyristor/Thyristor Vishay Semiconductors
(SUPER MAGN-A-PAK Power Modules), 500 A

TRIGGERING				
PARAMETER	SYMBOL	TEST CONDITIONS	VALUES	UNITS
Maximum peak gate power	P_{GM}	$T_J = T_J$ maximum, $t_p \leq 5$ ms	10	W
Maximum peak average gate power	$P_{G(AV)}$	$T_J = T_J$ maximum, $f = 50$ Hz, $d\% = 50$	2.0	
Maximum peak positive gate current	$+I_{GM}$	$T_J = T_J$ maximum, $t_p \leq 5$ ms	3.0	A
Maximum peak positive gate voltage	$+V_{GM}$		20	V
Maximum peak negative gate voltage	$-V_{GM}$		5.0	
Maximum DC gate current required to trigger	I_{GT}	$T_J = 25$ °C, $V_{ak} 12$ V	200	mA
DC gate voltage required to trigger	V_{GT}		3.0	V
DC gate current not to trigger	I_{GD}	$T_J = T_J$ maximum	10	mA
DC gate voltage not to trigger	V_{GD}		0.25	V

THERMAL AND MECHANICAL SPECIFICATIONS				
PARAMETER	SYMBOL	TEST CONDITIONS	VALUES	UNITS
Maximum junction operating temperature range	T_J		- 40 to 130	°C
Maximum storage temperature range	T_{Stg}		- 40 to 150	
Maximum thermal resistance, junction to case per junction	R_{thJC}	DC operation	0.065	K/W
Maximum thermal resistance, case to heatsink	R_{thC-hs}		0.02	
Mounting torque ± 10 %	SMAP to heatsink busbar to SMAP	A mounting compound is recommended and the torque should be rechecked after a period of 3 hours to allow for the spread of the compound.	6 to 8	Nm
			12 to 15	
Approximate weight			1500	g
Case style		See dimensions - link at the end of datasheet	SUPER MAGN-A-PAK	

ΔR_{thJC} CONDUCTION				
CONDUCTION ANGLE	SINUSOIDAL CONDUCTION	RECTANGULAR CONDUCTION	TEST CONDITIONS	UNITS
180°	0.009	0.006	$T_J = T_J$ maximum	K/W
120°	0.011	0.011		
90°	0.014	0.015		
60°	0.021	0.022		
30°	0.037	0.038		

Note

- Table shows the increment of thermal resistance R_{thJC} when devices operate at different conduction angles than DC

VSKT500-..PbF, VSKH500-..PbF, VSKL500-..PbF



Vishay Semiconductors Thyristor/Diode and Thyristor/Thyristor
(SUPER MAGN-A-PAK Power Modules), 500 A

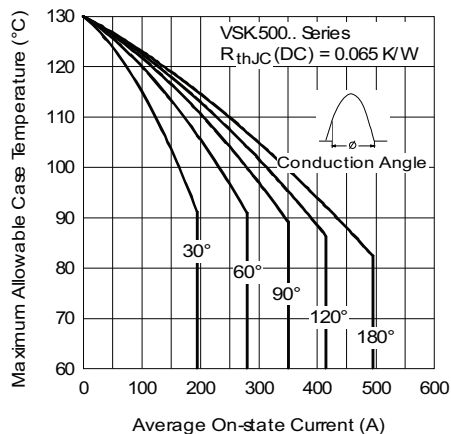

Fig. 1 - Current Ratings Characteristics

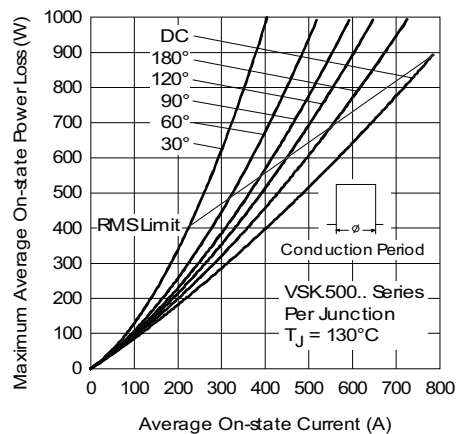

Fig. 4 - On-State Power Loss Characteristics

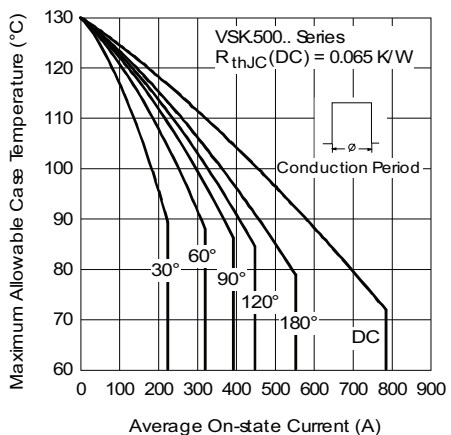

Fig. 2 - Current Ratings Characteristics

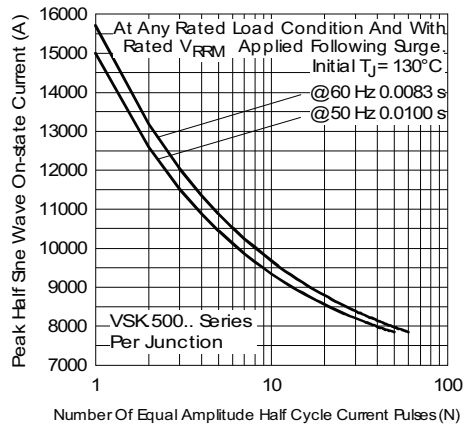

Fig. 5 - Maximum Non-Repetitive Surge Current

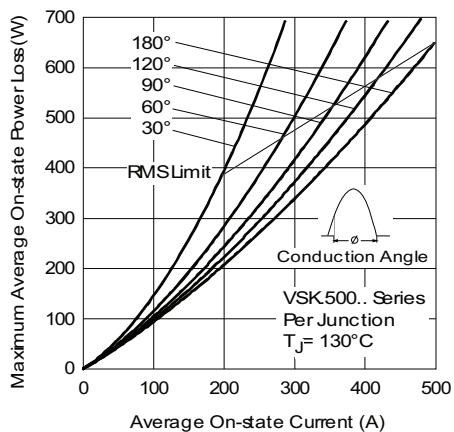

Fig. 3 - On-State Power Loss Characteristics

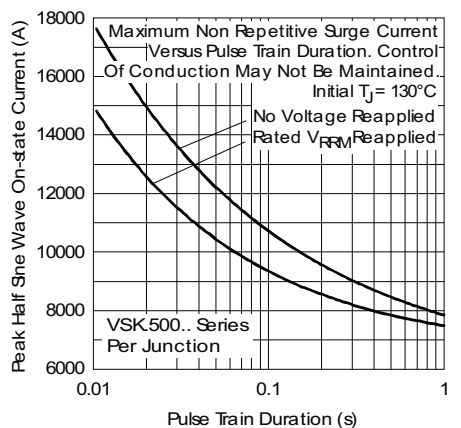

Fig. 6 - Maximum Non-Repetitive Surge Current



VSKT500-..PbF, VSKH500-..PbF, VSKL500-..PbF

Thyristor/Diode and Thyristor/Thyristor Vishay Semiconductors
(SUPER MAGN-A-PAK Power Modules), 500 A

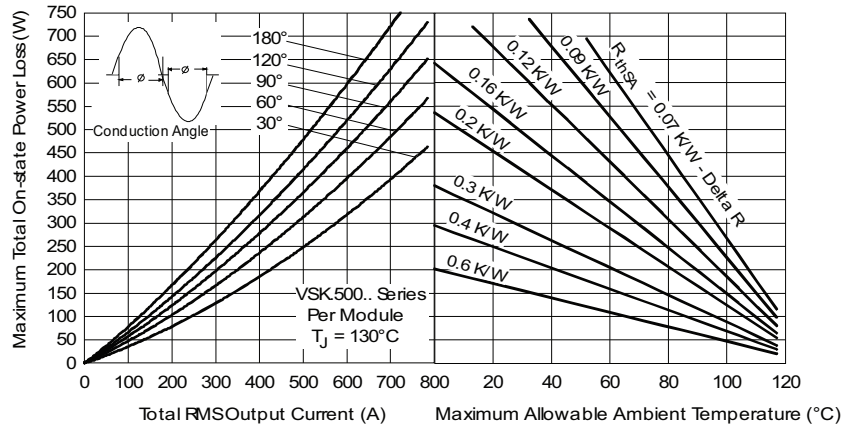

Fig. 7 - On-State Power Loss Characteristics

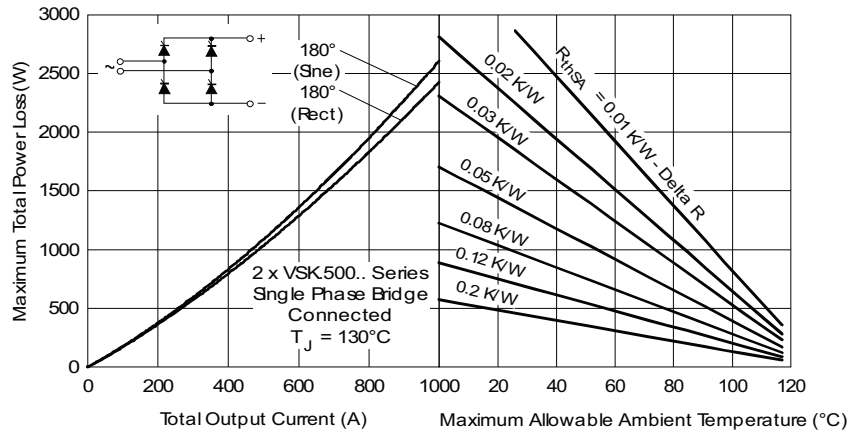

Fig. 8 - On-State Power Loss Characteristics

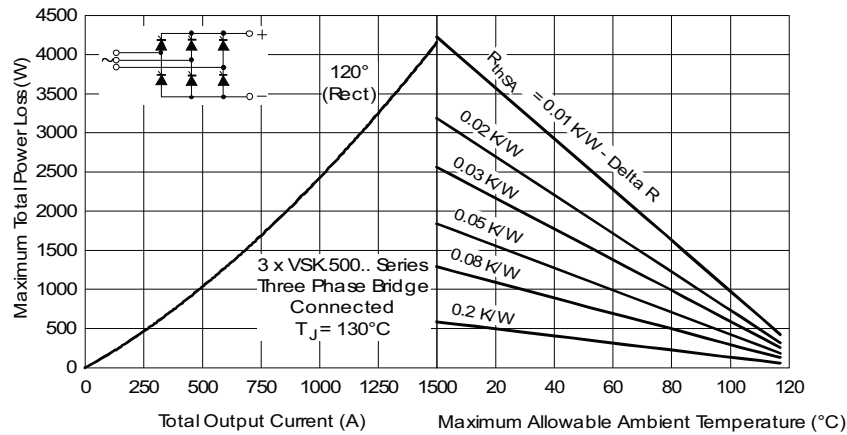

Fig. 9 - On-State Power Loss Characteristics

VSKT500-..PbF, VSKH500-..PbF, VSKL500-..PbF



Vishay Semiconductors Thyristor/Diode and Thyristor/Thyristor
(SUPER MAGN-A-PAK Power Modules), 500 A

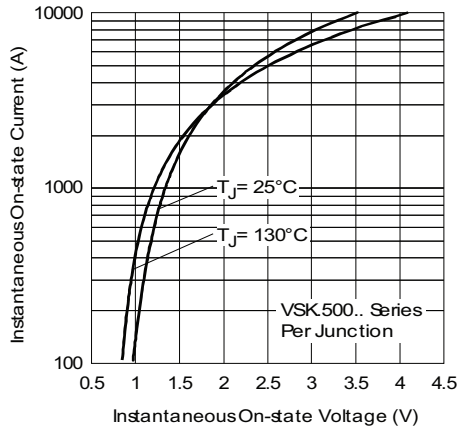

Fig. 10 - On-State Voltage Drop Characteristics

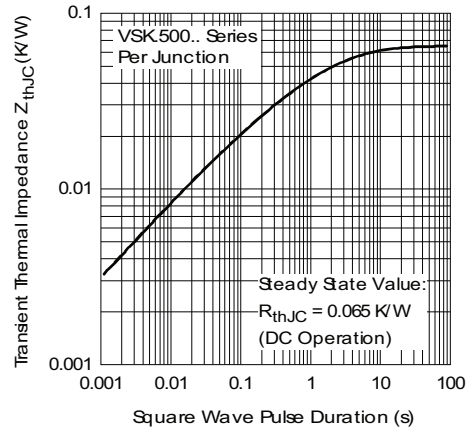

Fig. 11 - Thermal Impedance Z_{thJC} Characteristics

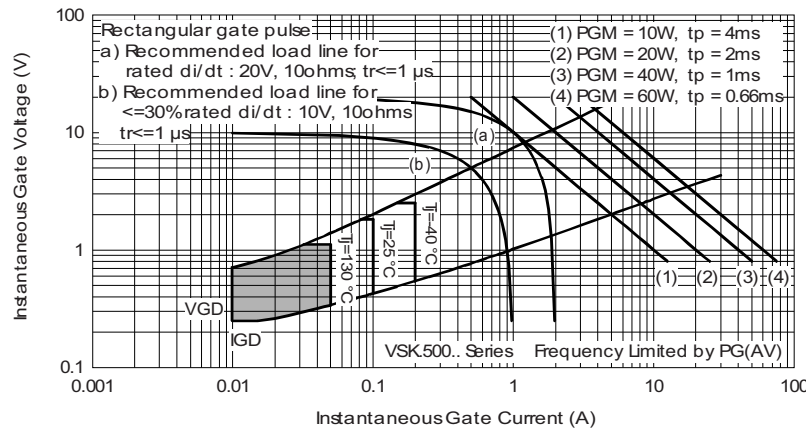

Fig. 12 - Gate Characteristics

ORDERING INFORMATION TABLE

Device code	VSK	T	500	-	16	PbF	
	①	②	③	④	⑤		
	①	-					Module type
	②	-					Circuit configuration (see end of datasheet)
	③	-					Current rating
	④	-					Voltage code x 100 = V_{RRM} (see Voltage Ratings table)
	⑤	-					Lead (Pb)-free

Note

- To order the optional hardware go to www.vishay.com/doc?95172



VSKT500-..PbF, VSKH500-..PbF, VSKL500-..PbF

Thyristor/Diode and Thyristor/Thyristor Vishay Semiconductors
(SUPER MAGN-A-PAK Power Modules), 500 A

CIRCUIT CONFIGURATION

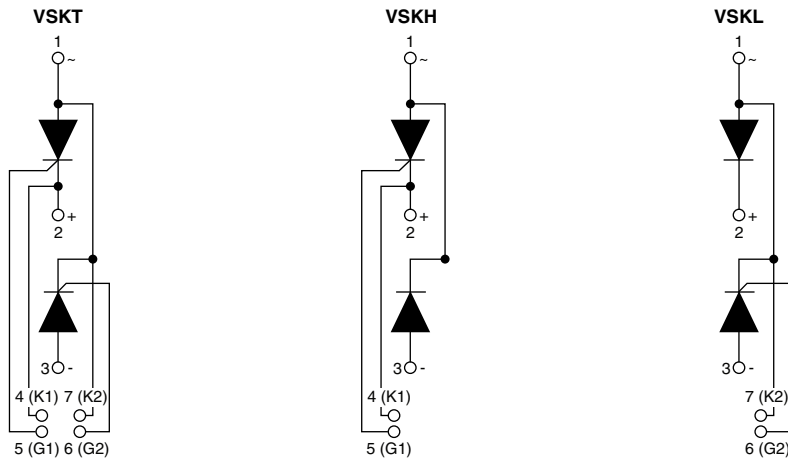

LINKS TO RELATED DOCUMENTS

Dimensions

www.vishay.com/doc?95283

Super MAGN-A-PAK Thyristor/Diode

DIMENSIONS in millimeters (inches)

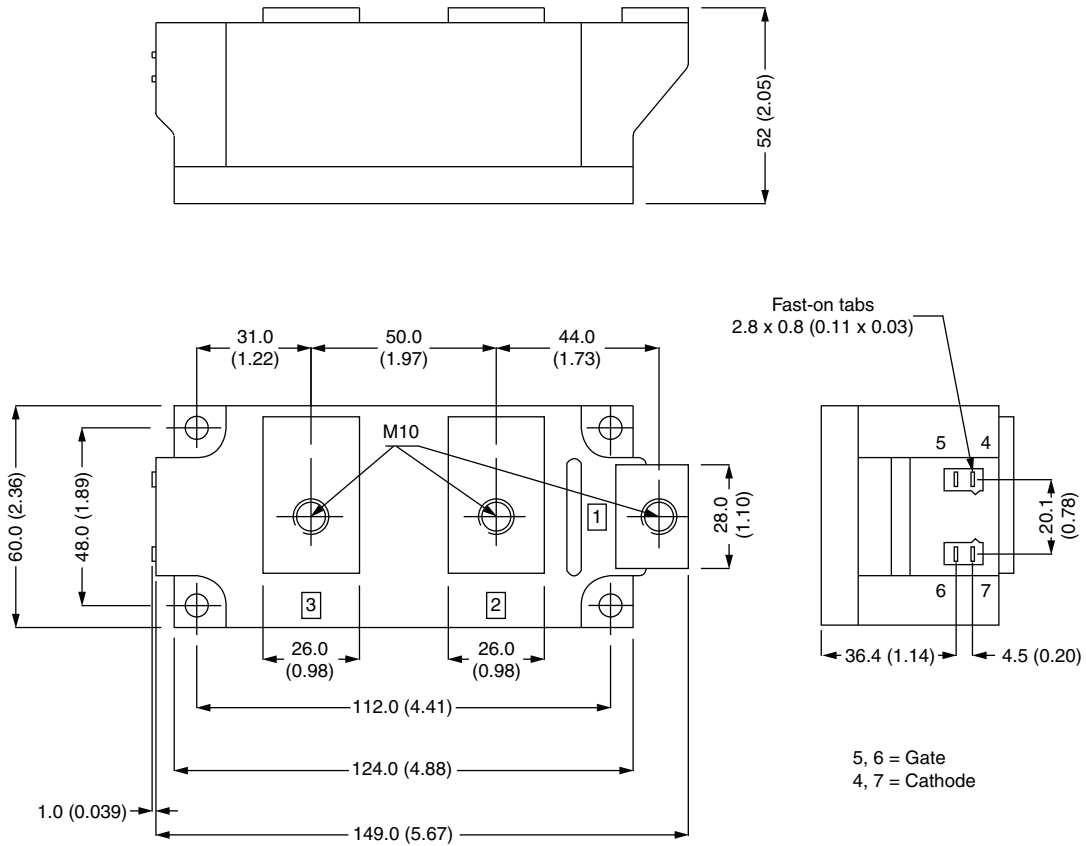



Disclaimer

ALL PRODUCT, PRODUCT SPECIFICATIONS AND DATA ARE SUBJECT TO CHANGE WITHOUT NOTICE TO IMPROVE RELIABILITY, FUNCTION OR DESIGN OR OTHERWISE.

Vishay Intertechnology, Inc., its affiliates, agents, and employees, and all persons acting on its or their behalf (collectively, "Vishay"), disclaim any and all liability for any errors, inaccuracies or incompleteness contained in any datasheet or in any other disclosure relating to any product.

Vishay makes no warranty, representation or guarantee regarding the suitability of the products for any particular purpose or the continuing production of any product. To the maximum extent permitted by applicable law, Vishay disclaims (i) any and all liability arising out of the application or use of any product, (ii) any and all liability, including without limitation special, consequential or incidental damages, and (iii) any and all implied warranties, including warranties of fitness for particular purpose, non-infringement and merchantability.

Statements regarding the suitability of products for certain types of applications are based on Vishay's knowledge of typical requirements that are often placed on Vishay products in generic applications. Such statements are not binding statements about the suitability of products for a particular application. It is the customer's responsibility to validate that a particular product with the properties described in the product specification is suitable for use in a particular application. Parameters provided in datasheets and/or specifications may vary in different applications and performance may vary over time. All operating parameters, including typical parameters, must be validated for each customer application by the customer's technical experts. Product specifications do not expand or otherwise modify Vishay's terms and conditions of purchase, including but not limited to the warranty expressed therein.

Except as expressly indicated in writing, Vishay products are not designed for use in medical, life-saving, or life-sustaining applications or for any other application in which the failure of the Vishay product could result in personal injury or death. Customers using or selling Vishay products not expressly indicated for use in such applications do so at their own risk and agree to fully indemnify and hold Vishay and its distributors harmless from and against any and all claims, liabilities, expenses and damages arising or resulting in connection with such use or sale, including attorneys fees, even if such claim alleges that Vishay or its distributor was negligent regarding the design or manufacture of the part. Please contact authorized Vishay personnel to obtain written terms and conditions regarding products designed for such applications.

No license, express or implied, by estoppel or otherwise, to any intellectual property rights is granted by this document or by any conduct of Vishay. Product names and markings noted herein may be trademarks of their respective owners.

Компания «Океан Электроники» предлагает заключение долгосрочных отношений при поставках импортных электронных компонентов на взаимовыгодных условиях!

Наши преимущества:

- Поставка оригинальных импортных электронных компонентов напрямую с производств Америки, Европы и Азии, а так же с крупнейших складов мира;
- Широкая линейка поставок активных и пассивных импортных электронных компонентов (более 30 млн. наименований);
- Поставка сложных, дефицитных, либо снятых с производства позиций;
- Оперативные сроки поставки под заказ (от 5 рабочих дней);
- Экспресс доставка в любую точку России;
- Помощь Конструкторского Отдела и консультации квалифицированных инженеров;
- Техническая поддержка проекта, помощь в подборе аналогов, поставка прототипов;
- Поставка электронных компонентов под контролем ВП;
- Система менеджмента качества сертифицирована по Международному стандарту ISO 9001;
- При необходимости вся продукция военного и аэрокосмического назначения проходит испытания и сертификацию в лаборатории (по согласованию с заказчиком);
- Поставка специализированных компонентов военного и аэрокосмического уровня качества (Xilinx, Altera, Analog Devices, Intersil, Interpoint, Microsemi, Actel, Aeroflex, Peregrine, VPT, Syfer, Eurofarad, Texas Instruments, MS Kennedy, Miteq, Cobham, E2V, MA-COM, Hittite, Mini-Circuits, General Dynamics и др.);

Компания «Океан Электроники» является официальным дистрибьютором и эксклюзивным представителем в России одного из крупнейших производителей разъемов военного и аэрокосмического назначения «JONHON», а так же официальным дистрибьютором и эксклюзивным представителем в России производителя высокотехнологичных и надежных решений для передачи СВЧ сигналов «FORSTAR».



JONHON

«JONHON» (основан в 1970 г.)

Разъемы специального, военного и аэрокосмического назначения:

(Применяются в военной, авиационной, аэрокосмической, морской, железнодорожной, горно- и нефтедобывающей отраслях промышленности)

«FORSTAR» (основан в 1998 г.)

ВЧ соединители, коаксиальные кабели,
кабельные сборки и микроволновые компоненты:

(Применяются в телекоммуникациях гражданского и специального назначения, в средствах связи, РЛС, а так же военной, авиационной и аэрокосмической отраслях промышленности).



Телефон: 8 (812) 309-75-97 (многоканальный)

Факс: 8 (812) 320-03-32

Электронная почта: ocean@oceanchips.ru

Web: <http://oceanchips.ru/>

Адрес: 198099, г. Санкт-Петербург, ул. Калинина, д. 2, корп. 4, лит. А