

Series: Low Profile Blade

Description: 3G/Active GNSS Blade Antenna

PART NUMBER: W4120GNSS5000



### Features:

- 2-Feeds (3G, GNSS)
- GNSS Active Antenna
  - LNA gain 30dB
  - Pre and post LNA filtering
- Adhesive tape mount
- Size 136 x 37.7 x 13.8mm
- Connector SMA Male
- Cable 16.4 feet
- RoHS compliant

### Applications:

- 3G 806-2170MHz
- GNSS (Beidou, GPS, Galileo, Glonass)
- Vehicular mounting
- Asset Tracking, Navigation, Fleet Management
- Mobile and Fixed broadband
- Utility boxes

All dimensions are in mm / inches

Issue: 1709

In the effort to improve our products, we reserve the right to make changes judged to be necessary.

CONFIDENTIAL AND PROPRIETARY INFORMATION

This document contains confidential and proprietary information of Pulse Electronics, Inc. (Pulse) and is protected by copyright, trade secret and other state and federal laws. Its receipt or possession does not convey any rights to reproduce, disclose its contents, or to manufacture, use or sell anything it may describe. Reproduction, disclosure or use without specific written authorization of Pulse is strictly forbidden.

For more information:

Pulse Worldwide Headquarters  
15255 Innovation Drive #100  
San Diego, CA 92128  
USA  
Tel: 1-858-674-8100

Pulse/Larsen Antennas  
18110 SE 34<sup>th</sup> St Bldg 2 Suite 250  
Vancouver, WA 98683  
USA  
Tel: 1-360-944-7551

Europe Headquarters  
Pulse GmbH & Do, KG  
Zeppelinstrasse 15  
Herrenberg, Germany  
Tel: 49 7032 7806 0

Pulse (Suzhou) Wireless Products Co, Inc.  
99 Huo Ju Road(#29 Bldg,4<sup>th</sup> Phase  
Suzhou New District  
Jiangsu Province, Suzhou 215009 PR China  
Tel: 86 512 6807 9998



Description: 3G/Active GNSS Blade Antenna

Series: Low Profile Blade

PART NUMBER: W4120GNSS5000

**ELECTRICAL SPECIFICATIONS**

Frequency(LTE Cable)	806-960/1710-2170	MHz
	1561.098 ± 2.046/	
Frequency(GNSS cable)	1575.42 ± 1.023/	MHz
	1602.5625 ± 4	
Nominal Impedance	50	Ω
VSWR (LTE)*	2.5:1	Max
VSWR (GNSS)*	2:1	Max
Peak Gain (LTE,698-960MHz,Typical)**	1.7	dBi
Peak Gain (LTE,1710-2700MHz,Typical)**	2.9	dBi
Efficiency (LTE,698-960MHz,Typical)**	55	%
Efficiency (LTE,1710-2700MHz,Typical)**	75	%
HPBW / Horizontal Plane (LTE/WiFi)**		Omni
HPBW / Vertical Plane (LTE, 698-960MHz, Typical)**		32°
HPBW / Vertical Plane (LTE,1710-2700MHz, Typical)**		50°
Polarization (LTE)		Vertical
Polarization (GNSS)		RHCP
RHCP Peak Gain (GNSS Radiating element, Typical)***	1	dBic
Gain (LNA gain)	30	dB ± 2 dB
Out of Band Rejection		
698 MHz	>70	dB
960MHz	>65	dB
1710MHz	>60	dB
2170MHz	>65	dB
2400MHz	>65	dB
2700MHz	>65	dB

Issue: 1709

In the effort to improve our products, we reserve the right to make changes judged to be necessary.

CONFIDENTIAL AND PROPRIETARY INFORMATION

This document contains confidential and proprietary information of Pulse Electronics, Inc. (Pulse) and is protected by copyright, trade secret and other state and federal laws. Its receipt or possession does not convey any rights to reproduce, disclose its contents, or to manufacture, use or sell anything it may describe. Reproduction, disclosure or use without specific written authorization of Pulse is strictly forbidden.

Series: Low Profile Blade

Description: 3G/Active GNSS Blade Antenna

PART NUMBER: W4120GNSS5000

### ELECTRICAL SPECIFICATIONS

Noise Figure	<2.4 dB
Operating Voltage	3.3-5 Vdc±0.5V
Current Consumption	9 mA± 2 mA

### MECHANICAL SPECIFICATIONS

Overall size	136 x 37.7 x 13.8mm
Weight	194g
Antenna Color	black
Connector type	SMA male
Cable type (LTE)	RG174
Cable type (GNSS)	RG174
Cable length	16.4' (5 m)

### ENVIRONMENTAL SPECIFICATIONS

Operating Temperature	-40/+85 ° C
Storage Temperature	-40/+85 ° C
Ingress Protection	IP67
Wind-loading	100mph
RoHS Compliant	Yes

### OTHER SPECIFICATIONS

Mounting	Adhesive Tape
Radome Material	PC/PET, UV resistant

Issue: 1709

In the effort to improve our products, we reserve the right to make changes judged to be necessary.

CONFIDENTIAL AND PROPRIETARY INFORMATION

This document contains confidential and proprietary information of Pulse Electronics, Inc. (Pulse) and is protected by copyright, trade secret and other state and federal laws. Its receipt or possession does not convey any rights to reproduce, disclose its contents, or to manufacture, use or sell anything it may describe. Reproduction, disclosure or use without specific written authorization of Pulse is strictly forbidden.

Description: 3G/Active GNSS Blade Antenna

Series: Low Profile Blade

PART NUMBER: W4120GNSS5000

MECHANICAL DRAWING

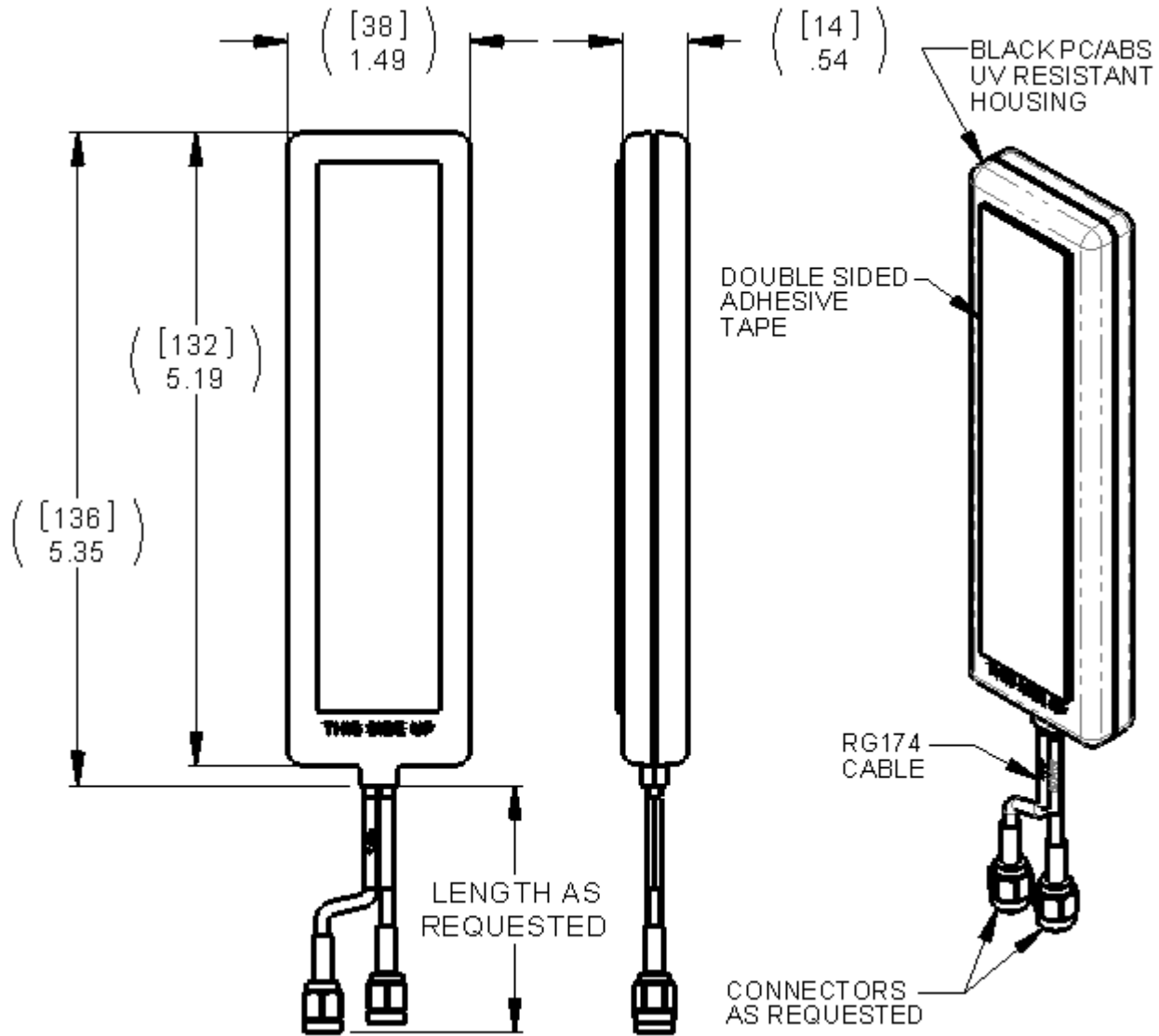

Issue: 1709

In the effort to improve our products, we reserve the right to make changes judged to be necessary.

CONFIDENTIAL AND PROPRIETARY INFORMATION

This document contains confidential and proprietary information of Pulse Electronics, Inc. (Pulse) and is protected by copyright, trade secret and other state and federal laws. Its receipt or possession does not convey any rights to reproduce, disclose its contents, or to manufacture, use or sell anything it may describe. Reproduction, disclosure or use without specific written authorization of Pulse is strictly forbidden.

Series: Low Profile Blade

Description: 3G/Active GNSS Blade Antenna

PART NUMBER: W4120GNSS5000

### Test Setup

\*VSWR is tested with 5m cable in free space

\*\* Radiation Performance is tested with 200mm cable in free space

\*\*\*GNSS module is tested on 70X70mm ground plane

Description: 3G/Active GNSS Blade Antenna

Series: Low Profile Blade

PART NUMBER: W4120GNSS5000

CHARTS

VSWR of 3G antenna

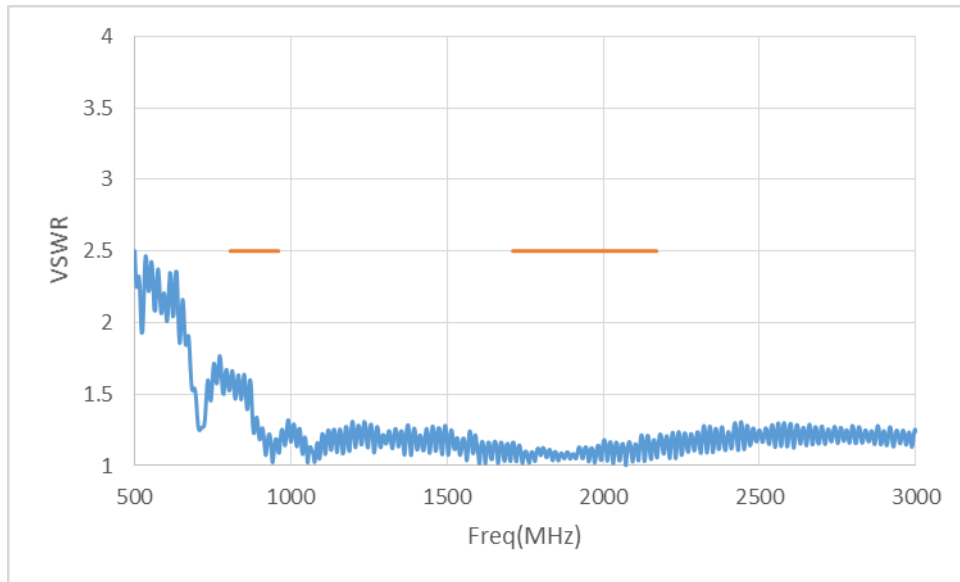

Radiation efficiency of 3G antenna

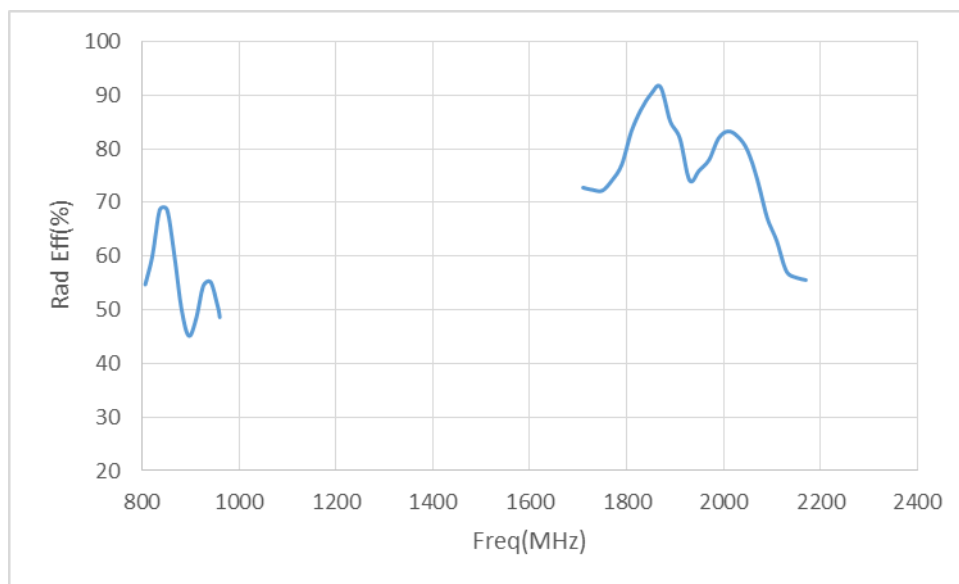

Issue: 1709

In the effort to improve our products, we reserve the right to make changes judged to be necessary.

CONFIDENTIAL AND PROPRIETARY INFORMATION

This document contains confidential and proprietary information of Pulse Electronics, Inc. (Pulse) and is protected by copyright, trade secret and other state and federal laws. Its receipt or possession does not convey any rights to reproduce, disclose its contents, or to manufacture, use or sell anything it may describe. Reproduction, disclosure or use without specific written authorization of Pulse is strictly forbidden.

Description: 3G/Active GNSS Blade Antenna

Series: Low Profile Blade

PART NUMBER: W4120GNSS5000

CHARTS

Peak Gain of 3G antenna

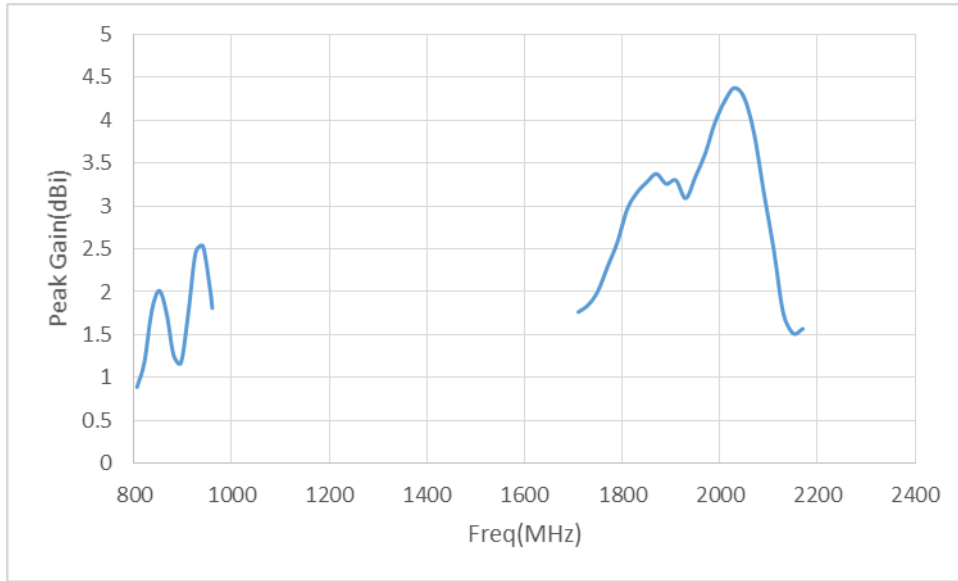

3G antenna X-Y plane radiation pattern at 3G low band

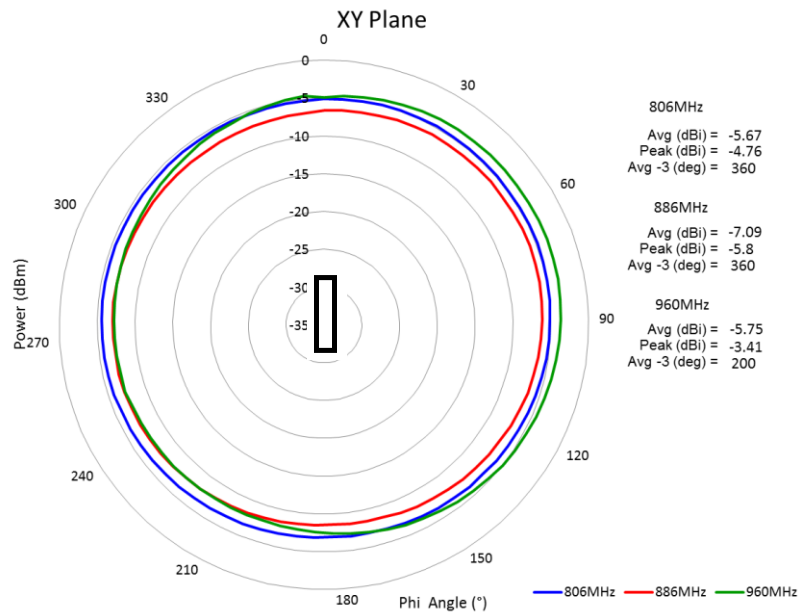

Issue: 1709

In the effort to improve our products, we reserve the right to make changes judged to be necessary.

CONFIDENTIAL AND PROPRIETARY INFORMATION

This document contains confidential and proprietary information of Pulse Electronics, Inc. (Pulse) and is protected by copyright, trade secret and other state and federal laws. Its receipt or possession does not convey any rights to reproduce, disclose its contents, or to manufacture, use or sell anything it may describe. Reproduction, disclosure or use without specific written authorization of Pulse is strictly forbidden.

Description: 3G/Active GNSS Blade Antenna

Series: Low Profile Blade

PART NUMBER: W4120GNSS5000

CHARTS

3G antenna Z-X plane radiation pattern at 3G low band

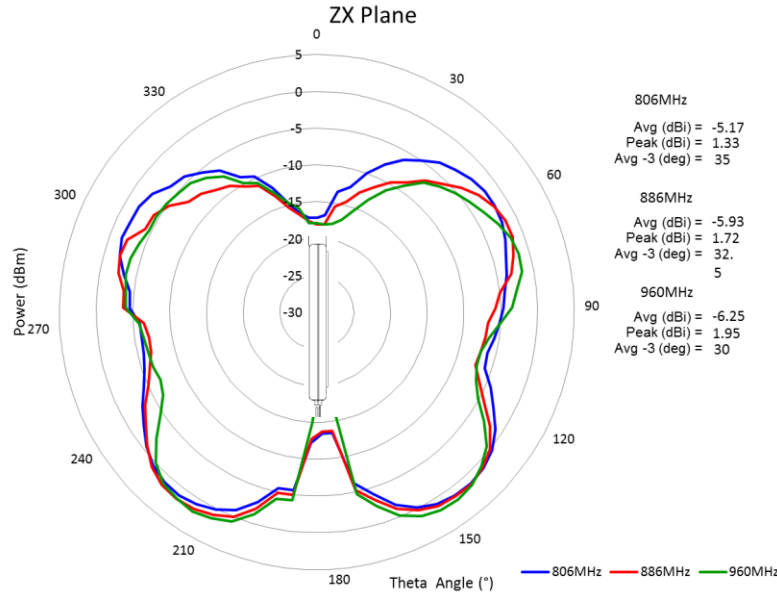

3G antenna Y-Z plane radiation pattern at 3G low band

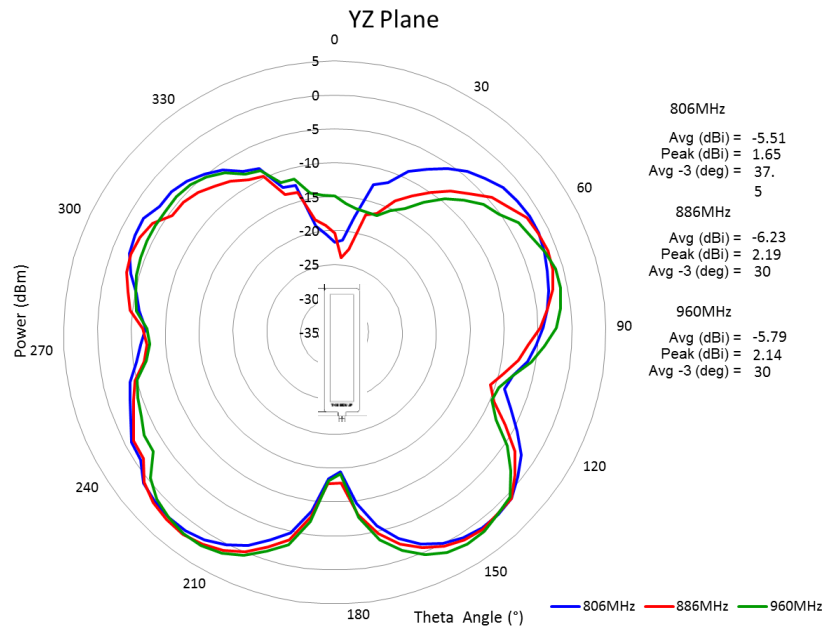

Issue: 1709

In the effort to improve our products, we reserve the right to make changes judged to be necessary.

CONFIDENTIAL AND PROPRIETARY INFORMATION

This document contains confidential and proprietary information of Pulse Electronics, Inc. (Pulse) and is protected by copyright, trade secret and other state and federal laws. Its receipt or possession does not convey any rights to reproduce, disclose its contents, or to manufacture, use or sell anything it may describe. Reproduction, disclosure or use without specific written authorization of Pulse is strictly forbidden.



Description: 3G/Active GNSS Blade Antenna

Series: Low Profile Blade

PART NUMBER: W4120GNSS5000

CHARTS

3G antenna X-Y plane radiation pattern at 3G high band

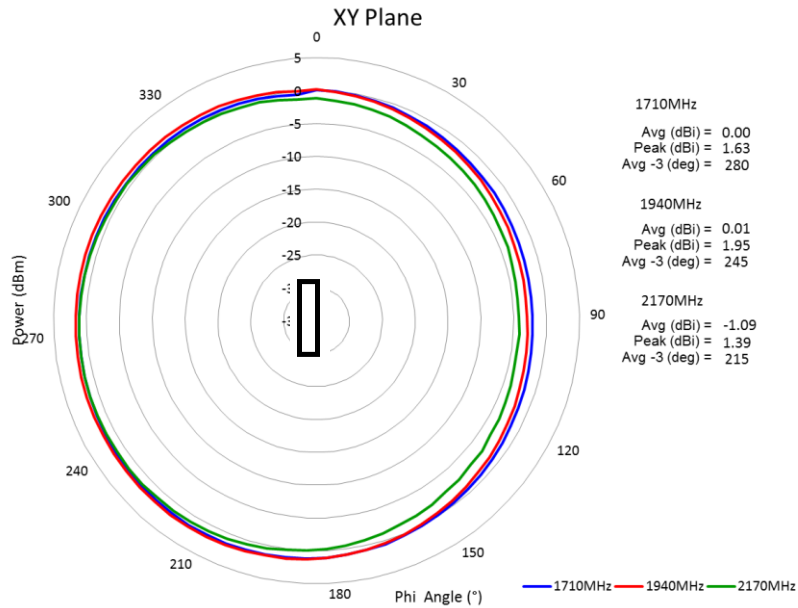

3G antenna Z-X plane radiation pattern at 3G high band

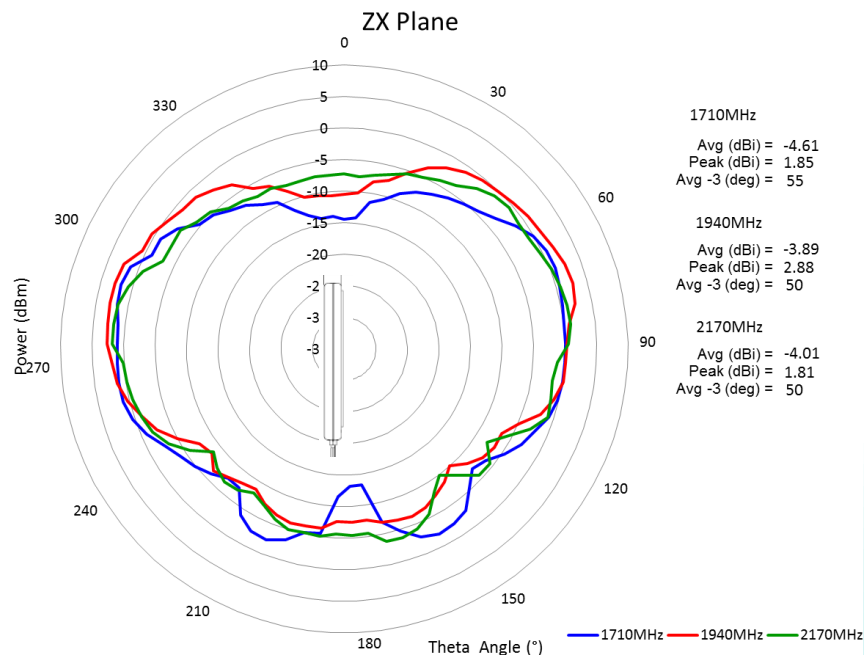

Issue: 1709

In the effort to improve our products, we reserve the right to make changes judged to be necessary.

CONFIDENTIAL AND PROPRIETARY INFORMATION

This document contains confidential and proprietary information of Pulse Electronics, Inc. (Pulse) and is protected by copyright, trade secret and other state and federal laws. Its receipt or possession does not convey any rights to reproduce, disclose its contents, or to manufacture, use or sell anything it may describe. Reproduction, disclosure or use without specific written authorization of Pulse is strictly forbidden.

Description: 3G/Active GNSS Blade Antenna

Series: Low Profile Blade

PART NUMBER: W4120GNSS5000

CHARTS

3G antenna Y-Z plane radiation pattern at 3G high band

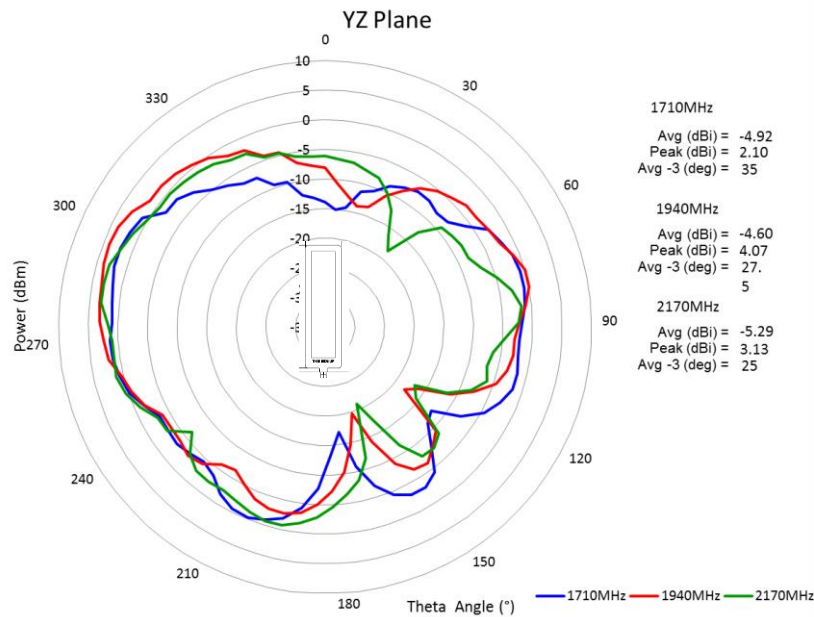

LNA Gain and out-of-band rejection

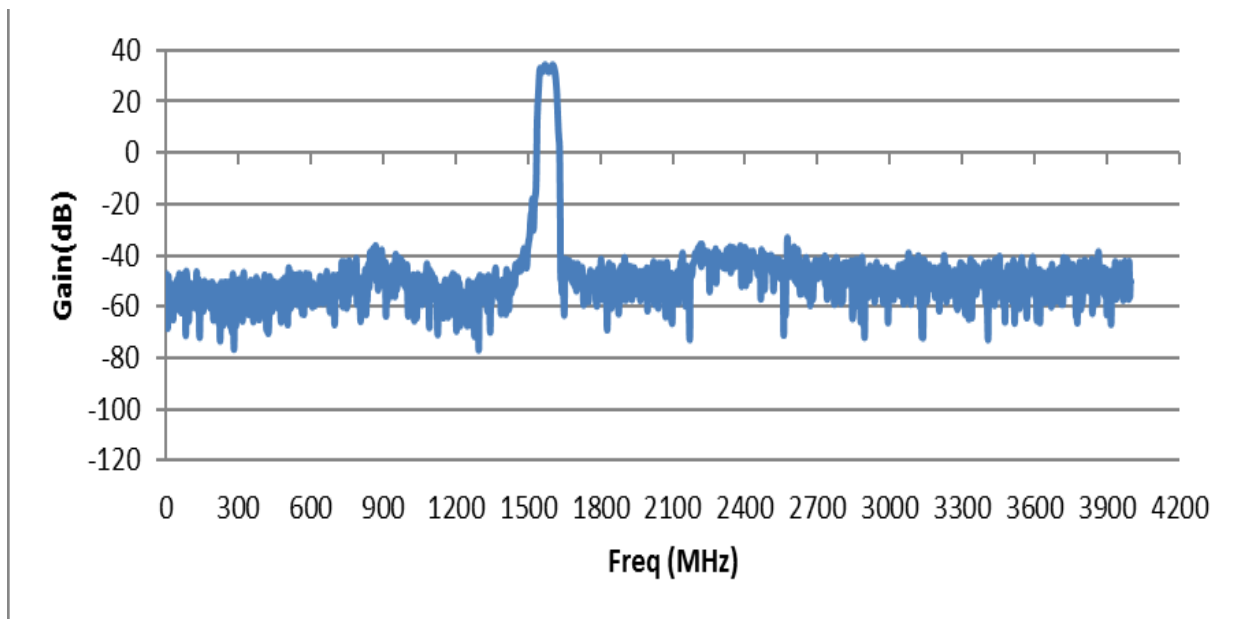

Issue: 1709

In the effort to improve our products, we reserve the right to make changes judged to be necessary.

CONFIDENTIAL AND PROPRIETARY INFORMATION

This document contains confidential and proprietary information of Pulse Electronics, Inc. (Pulse) and is protected by copyright, trade secret and other state and federal laws. Its receipt or possession does not convey any rights to reproduce, disclose its contents, or to manufacture, use or sell anything it may describe. Reproduction, disclosure or use without specific written authorization of Pulse is strictly forbidden.

**Description:** 3G/Active GNSS Blade Antenna

**Series:** Low Profile Blade

**PART NUMBER:** W4120GNSS5000

**CHARTS**

**Radiation Pattern (70mm x 70mm ground plane ) GPS & Galileo**

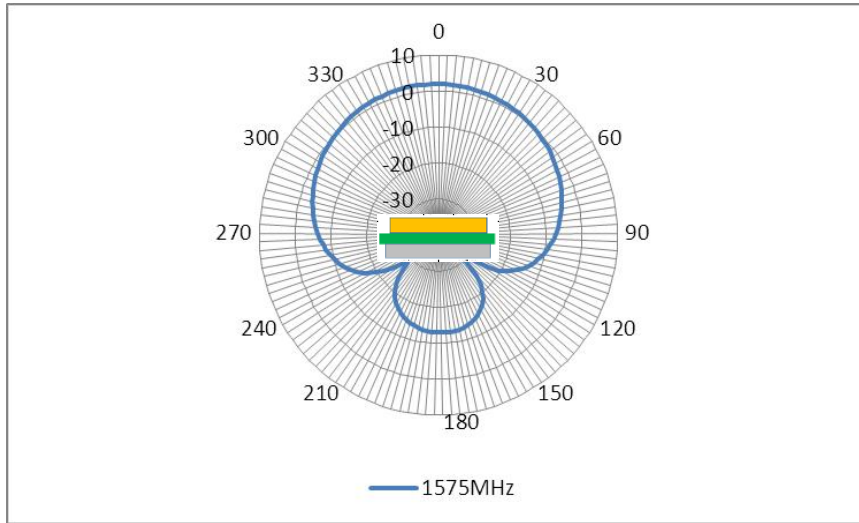

**Radiation Pattern (70mm x 70mm ground plane ) GLONASS**

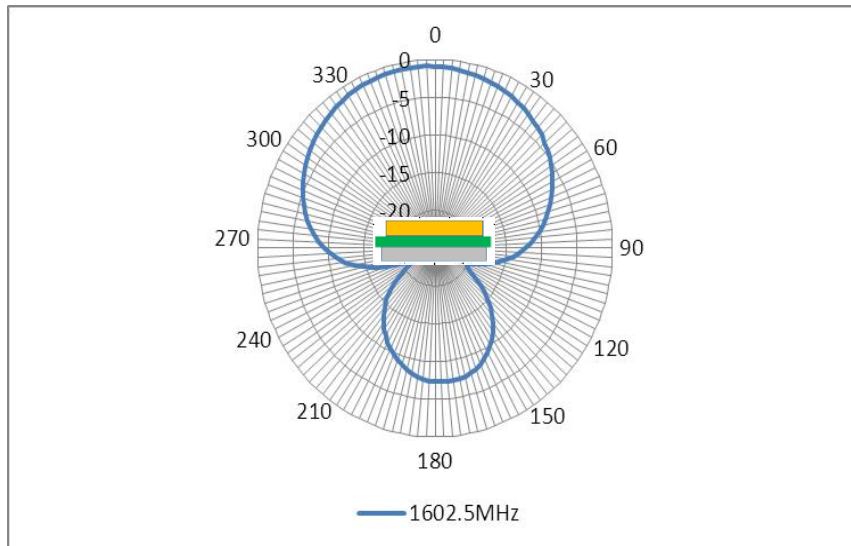

Issue: 1709

In the effort to improve our products, we reserve the right to make changes judged to be necessary.

CONFIDENTIAL AND PROPRIETARY INFORMATION

This document contains confidential and proprietary information of Pulse Electronics, Inc. (Pulse) and is protected by copyright, trade secret and other state and federal laws. Its receipt or possession does not convey any rights to reproduce, disclose its contents, or to manufacture, use or sell anything it may describe. Reproduction, disclosure or use without specific written authorization of Pulse is strictly forbidden.

Series: Low Profile Blade

Description: 3G/Active GNSS Blade Antenna

PART NUMBER: W4120GNSS5000

CHARTS

Radiation Pattern (70mm x 70mm ground plane ) BD2

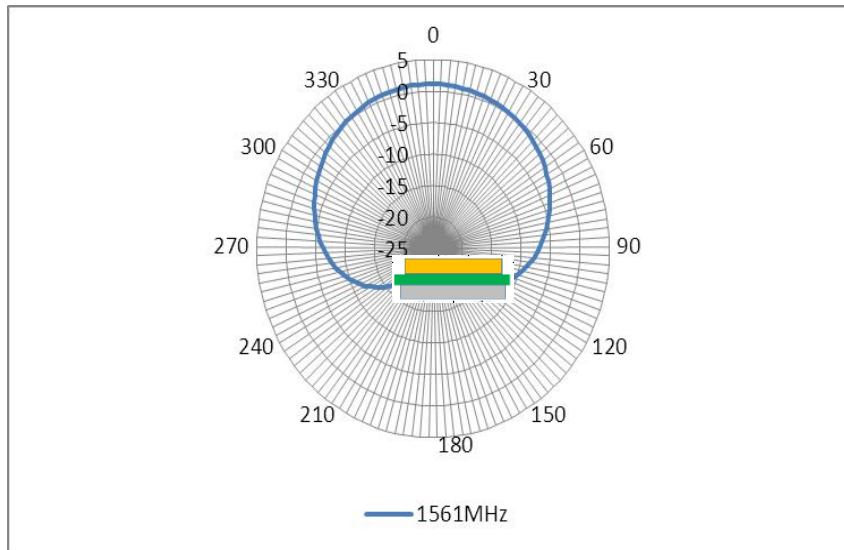

Issue: 1709

In the effort to improve our products, we reserve the right to make changes judged to be necessary.

CONFIDENTIAL AND PROPRIETARY INFORMATION

This document contains confidential and proprietary information of Pulse Electronics, Inc. (Pulse) and is protected by copyright, trade secret and other state and federal laws. Its receipt or possession does not convey any rights to reproduce, disclose its contents, or to manufacture, use or sell anything it may describe. Reproduction, disclosure or use without specific written authorization of Pulse is strictly forbidden.

Series: Low Profile Blade

Description: 3G/Active GNSS Blade Antenna

PART NUMBER: W4120GNSS5000

## PACKAGING

56pcs antennas per package box

56pcs PE bags per package box

1pcs antenna per PE bag

Package box: 440mm\*292mm\*310mm

Компания «Океан Электроники» предлагает заключение долгосрочных отношений при поставках импортных электронных компонентов на взаимовыгодных условиях!

Наши преимущества:

- Поставка оригинальных импортных электронных компонентов напрямую с производств Америки, Европы и Азии, а так же с крупнейших складов мира;
- Широкая линейка поставок активных и пассивных импортных электронных компонентов (более 30 млн. наименований);
- Поставка сложных, дефицитных, либо снятых с производства позиций;
- Оперативные сроки поставки под заказ (от 5 рабочих дней);
- Экспресс доставка в любую точку России;
- Помощь Конструкторского Отдела и консультации квалифицированных инженеров;
- Техническая поддержка проекта, помощь в подборе аналогов, поставка прототипов;
- Поставка электронных компонентов под контролем ВП;
- Система менеджмента качества сертифицирована по Международному стандарту ISO 9001;
- При необходимости вся продукция военного и аэрокосмического назначения проходит испытания и сертификацию в лаборатории (по согласованию с заказчиком);
- Поставка специализированных компонентов военного и аэрокосмического уровня качества (Xilinx, Altera, Analog Devices, Intersil, Interpoint, Microsemi, Actel, Aeroflex, Peregrine, VPT, Syfer, Eurofarad, Texas Instruments, MS Kennedy, Miteq, Cobham, E2V, MA-COM, Hittite, Mini-Circuits, General Dynamics и др.);

Компания «Океан Электроники» является официальным дистрибьютором и эксклюзивным представителем в России одного из крупнейших производителей разъемов военного и аэрокосмического назначения «JONHON», а так же официальным дистрибьютором и эксклюзивным представителем в России производителя высокотехнологичных и надежных решений для передачи СВЧ сигналов «FORSTAR».



## JONHON

«JONHON» (основан в 1970 г.)

Разъемы специального, военного и аэрокосмического назначения:

(Применяются в военной, авиационной, аэрокосмической, морской, железнодорожной, горно- и нефтедобывающей отраслях промышленности)

«FORSTAR» (основан в 1998 г.)

ВЧ соединители, коаксиальные кабели,  
кабельные сборки и микроволновые компоненты:

(Применяются в телекоммуникациях гражданского и специального назначения, в средствах связи, РЛС, а так же военной, авиационной и аэрокосмической отраслях промышленности).



Телефон: 8 (812) 309-75-97 (многоканальный)

Факс: 8 (812) 320-03-32

Электронная почта: [ocean@oceanchips.ru](mailto:ocean@oceanchips.ru)

Web: <http://oceanchips.ru/>

Адрес: 198099, г. Санкт-Петербург, ул. Калинина, д. 2, корп. 4, лит. А