



# TAOGLAS®



# Datasheet

**Part No:**  
MFX3.07.0150C

**Description:**  
NB-IoT / CAT M1 Wide Band Flex Antenna  
698MHz - 3000 MHz

**Features:**  
Patent Pending  
Ground Plane Independent  
NB-IoT / CAT M1 Bands  
698-3000 MHz  
>45% Efficiency on All bands  
5 dBi Peak Gain  
Dimensions: 96\*21\*0.2 mm  
Cable: 150mm of  $\varnothing$ 1.37mm  
Connector: IPEX MHFI (U.FL Compatible)  
RoHS & Reach Compliant

1. Introduction	3
2. Specifications	4
3. Antenna Characteristics	6
4. Radiation Patterns	8
5. Mechanical Drawing	12
6. Packaging	13
<hr/>	
Changelog	14

Taoglas makes no warranties based on the accuracy or completeness of the contents of this document and reserves the right to make changes to specifications and product descriptions at any time without notice. Taoglas reserves all rights to this document and the information contained herein. Reproduction, use or disclosure to third parties without express permission is strictly prohibited.



# 1. Introduction



The patent pending MFX3 ultra-wideband flexible antenna has been designed for NB-IoT / CAT M1 applications to provide highest efficiency and covers all working frequencies in the 698-3000MHz spectrum, covering all Cellular, 2.4GHz Wi-Fi, ISM and AGPS. The antenna is omni-directional, delivered with a flexible body with excellent efficiencies on all bands, ground independent, with cable and connector for easy installation.

NB-IoT / CAT M1 is a low power wide area (LPWA) technology specifically designed for IoT and M2M. NB-IoT / CAT M1 technology offers lower maintenance cost, with greater efficiency and reliability by reducing power consumption and providing deeper penetration compared to standard cellular technologies. It operates on secure mobile networks making it suited to automotive, smart meter, medical and smart city applications.

The MFX3 flexible polymer antenna, at 96\*21\*0.2mm, is extremely thin, and truly ultra-wideband, with high efficiencies across the bands. It is assembled by a simple “peel and stick” process, attaching securely to non-metal surfaces via 3M adhesive. It enables designers to use only one antenna that covers NB-IoT, CAT M1 and all common LTE frequencies.

The MFX3 is made of durable flexible polymer and is designed to be mounted directly onto a plastic or glass cover. It offers a peak gain of 5dBi, an efficiency of more than 45% across the bands and is an ideal choice for any device maker that needs to keep manufacturing costs down over the lifetime of a product. It is ground plane independent and delivered with a cable and connector for easy connecting to the wireless module or customer PCB.

Like all similar antennas, care should be taken to mount the antenna at least 10mm from metal components or surfaces, and ideally 20mm for best radiation efficiency. Cables and connectors are customizable, for further information contact your regional Taoglas customer support team.

## 2. Specifications

Electrical						
Frequency (MHz)	Band 2		Band 4		Band 12	
	Tx	Rx	Tx	Rx	Tx	Rx
	1850-1910	1930-1990	1710-1755	2110-2155	699-716	729-746
Peak Gain (dBi)	3.07	3.10	3.68	4.51	0.36	0.21
Efficiency (%)	75.98	71.07	68.22	82.01	45.59	44.35
Average Gain (dB)	-1.19	-1.48	-1.66	-0.86	-3.41	-3.53
Radiation Properties	Omni-directional					
Max Input Power (Watts)	5					
Polarization	Linear					
Impedance (Ohms)	50 Ohms					

\*Tested on 3mm ABS Plastic

Mechanical	
Dimensions (mm)	96*21*0.2 mm
Material	Flexible Polymer
Connector and Cable	U.FL and 1.37 mm mini coax
Cable Length	150 mm
Environmental	
Operation Temperature	-40°C to 85°C
Storage Temperature	-40°C to 85°C
Relative Humidity	40% to 95%
RoHs Compliant	Yes
REACH Compliant	Yes

5G/4G Bands			
Band Number	5G NR / FR1 / LTE / LTE-Advanced / WCDMA / HSPA / HSPA+ / TD-SCDMA		
	Uplink	Downlink	Covered
1	UL: 1920 to 1980	DL: 2110 to 2170	✓
2	UL: 1850 to 1910	DL: 1930 to 1990	✓
3	UL: 1710 to 1785	DL: 1805 to 1880	✓
4	UL: 1710 to 1755	DL: 2110 to 2155	✓
5	UL: 824 to 849	DL: 869 to 894	✓
7	UL: 2500 to 2570	DL: 2620 to 2690	✓
8	UL: 880 to 915	DL: 925 to 960	✓
9	UL: 1749.9 to 1784.9	DL: 1844.9 to 1879.9	✓
11	UL: 1427.9 to 1447.9	DL: 1475.9 to 1495.9	✗
12	UL: 699 to 716	DL: 729 to 746	✓
13	UL: 777 to 787	DL: 746 to 756	✓
14	UL: 788 to 798	DL: 758 to 768	✓
17	UL: 704 to 716	DL: 734 to 746	✓
18	UL: 815 to 830	DL: 860 to 875	✓
19	UL: 830 to 845	DL: 875 to 890	✓
20	UL: 832 to 862	DL: 791 to 821	✓
21	UL: 1447.9 to 1462.9	DL: 1495.9 to 1510.9	✗
22	UL: 3410 to 3490	DL: 3510 to 3590	✗
23	UL: 2000 to 2020	DL: 2180 to 2200	✓
24	UL: 1625.5 to 1660.5	DL: 1525 to 1559	✗
25	UL: 1850 to 1915	DL: 1930 to 1995	✓
26	UL: 814 to 849	DL: 859 to 894	✓
27	UL: 807 to 824	DL: 852 to 869	✓
28	UL: 703 to 748	DL: 758 to 803	✓
29	UL: -	DL: 717 to 728	✓
30	UL: 2305 to 2315	DL: 2350 to 2360	✓
31	UL: 452.5 to 457.5	DL: 462.5 to 467.5	✗
32	UL: -	DL: 1452 - 1496	✓
35		1850 to 1910	✓
38		2570 to 2620	✓
39		1880 to 1920	✓
40		2300 to 2400	✓
41		2496 to 2690	✓
42		3400 to 3600	✗
43		3600 to 3800	✗
48		3550 to 3700	✗
66	UL: 1710-1780	DL: 2110-2200	✓
71		617 to 698	✗
74/75/76		1427 to 1518	✗
78		3300 to 3800	✗
79		4400 to 5000	✗

### 3. Antenna Characteristics

#### 3.1 Return Loss

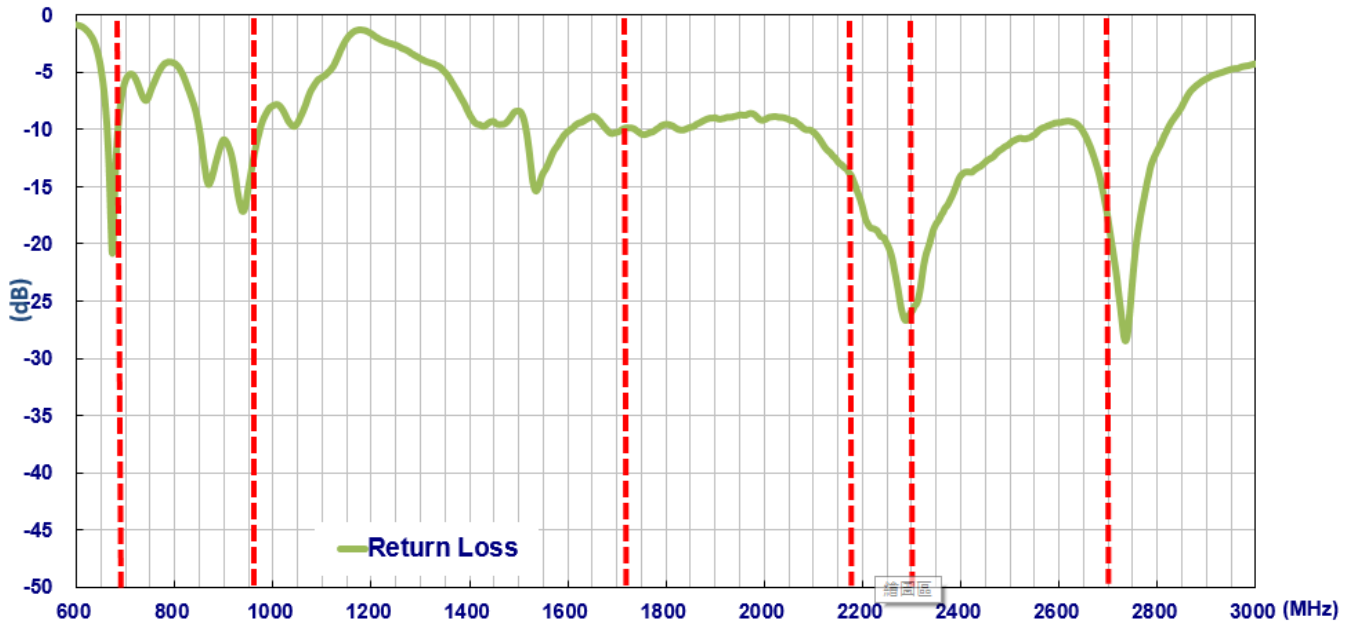

#### 3.2 Efficiency

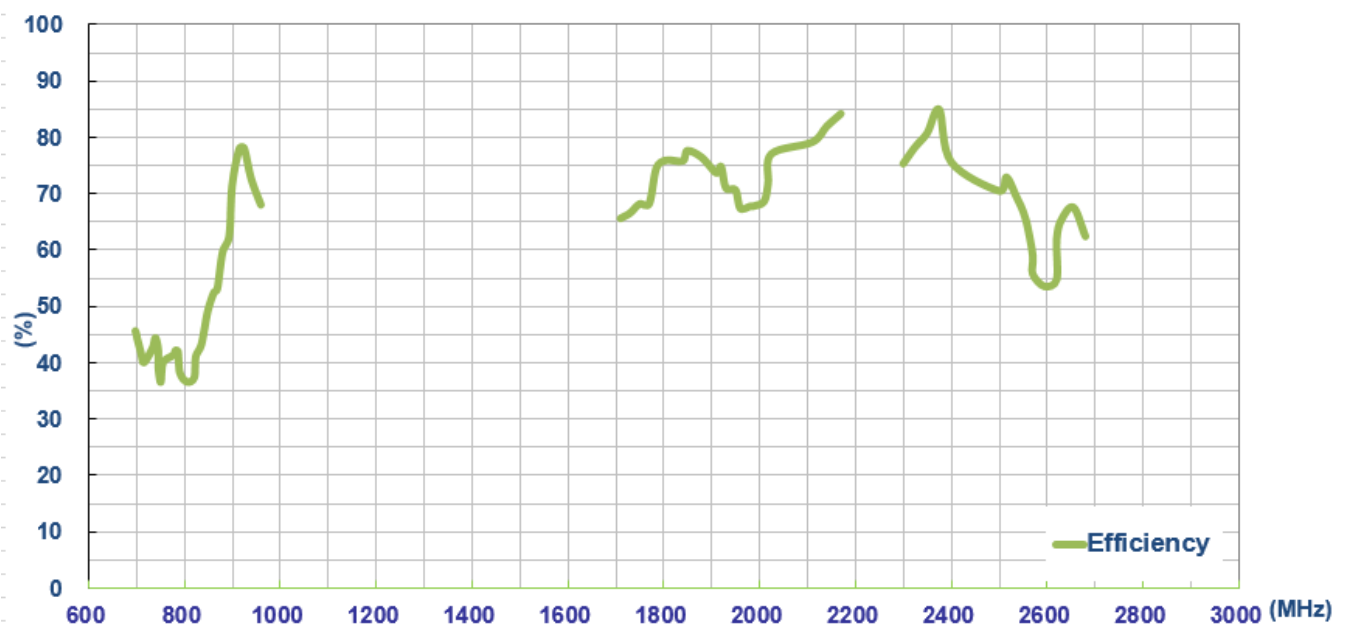

### 3.3 Average Gain

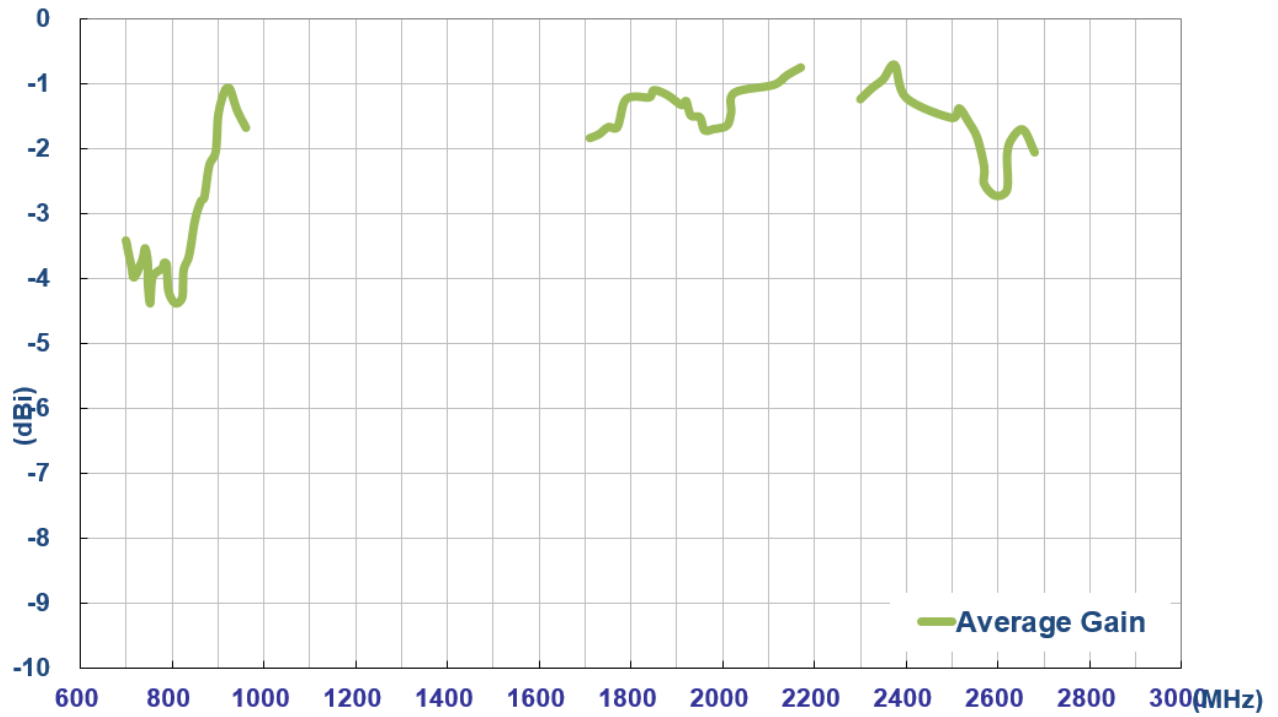

### 3.4 Peak Gain

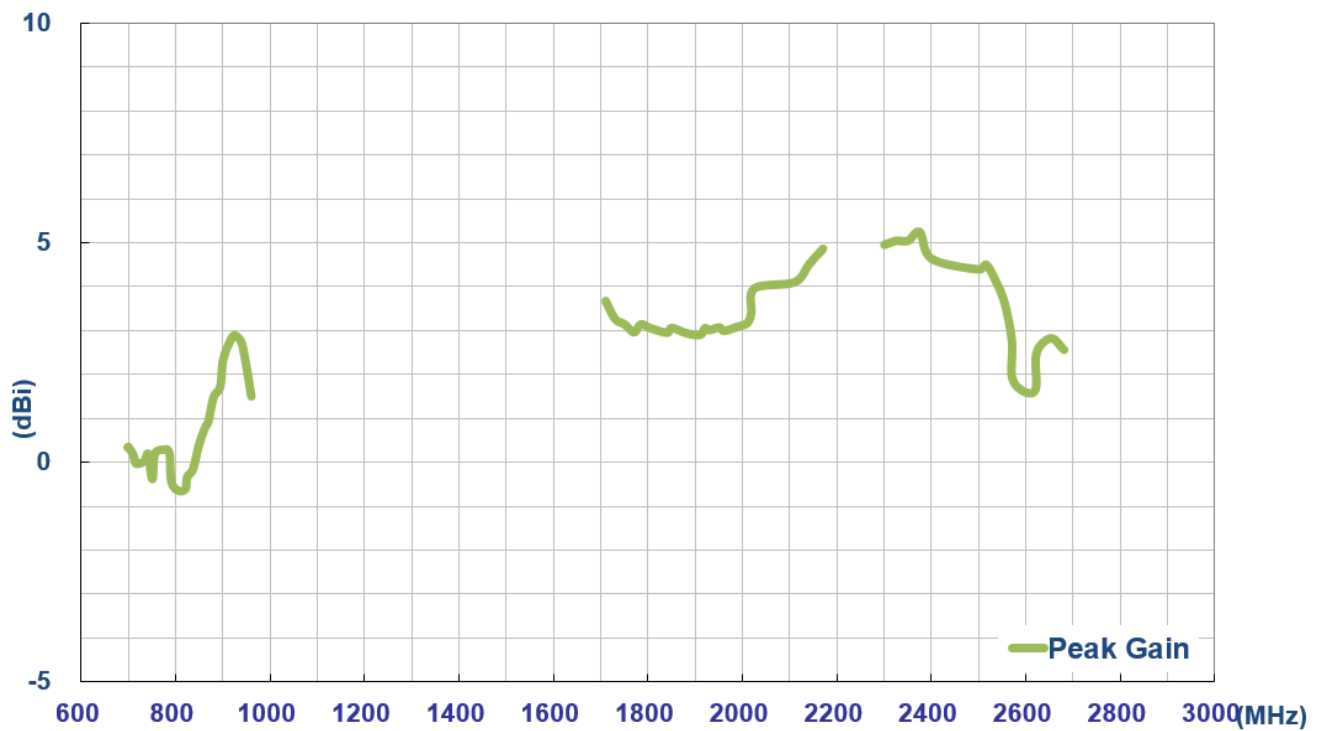

## 4. Radiation Patterns

### 4.1 Test Setup – on 3mm ABS

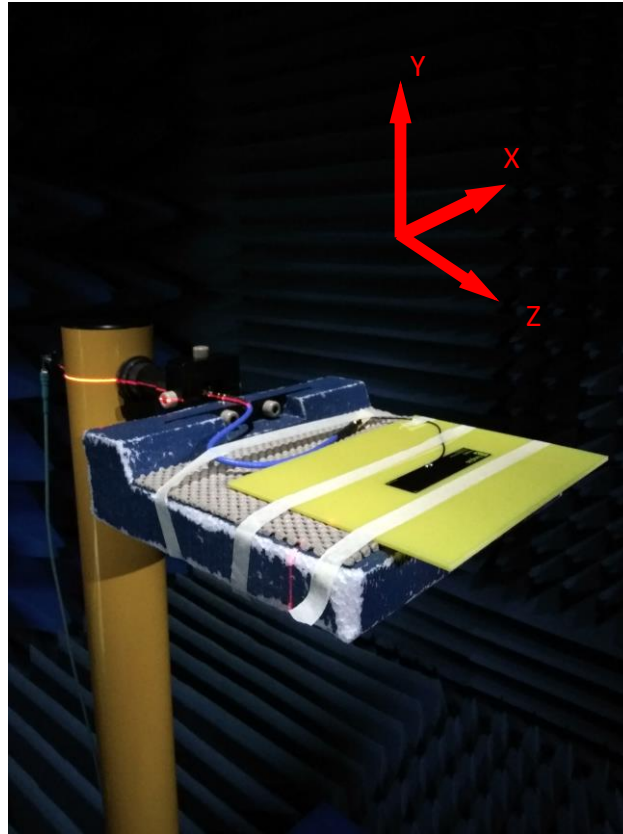



4.2 3D and 2D Radiation Patterns

704-960MHz

704MHz

824MHz

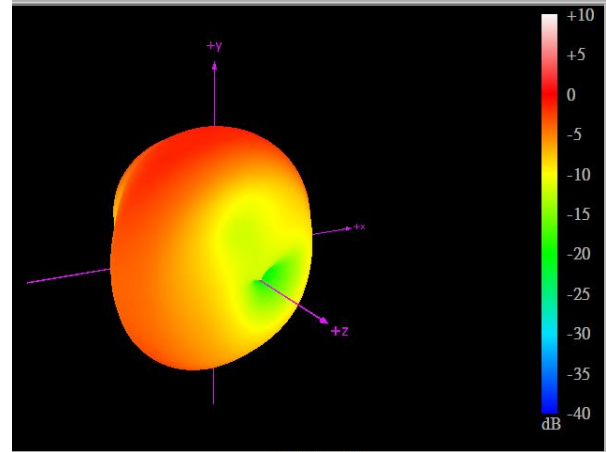
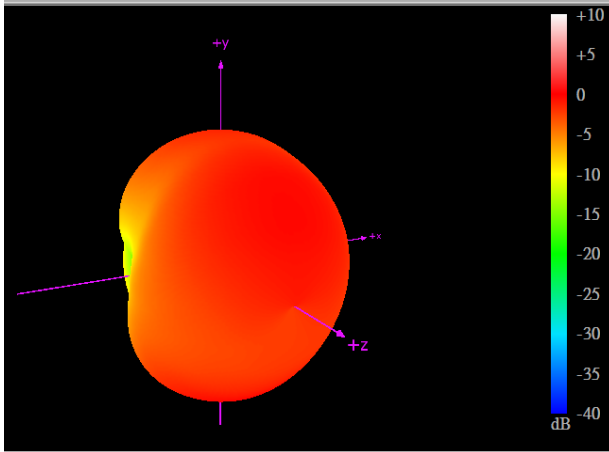

880MHz

960MHz

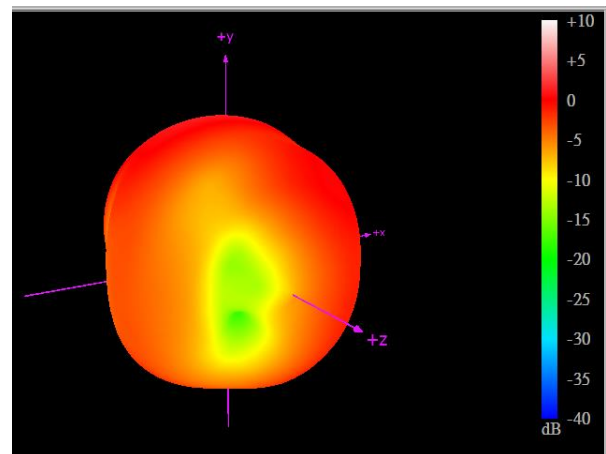
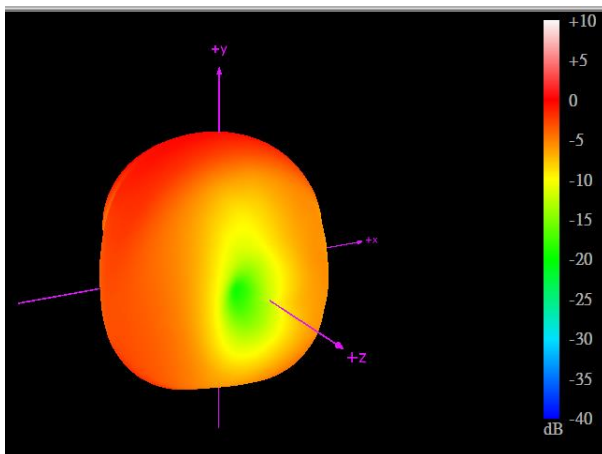

XY Plane

XZ Plane

YZ Plane

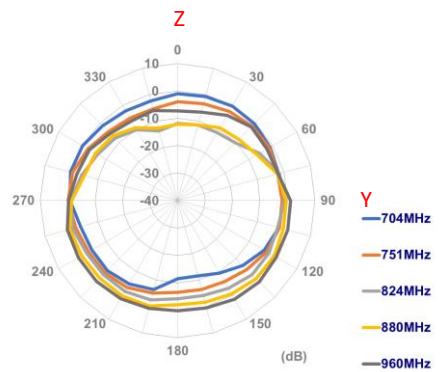
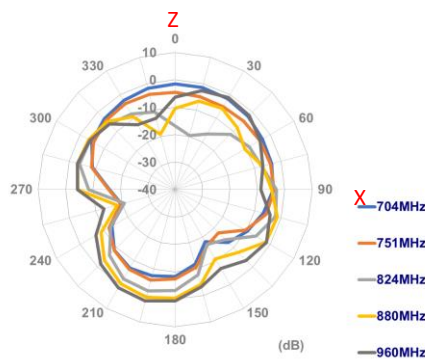
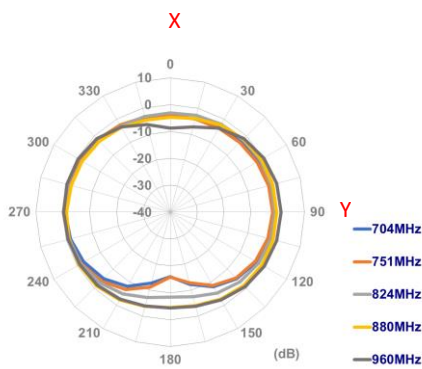

1710-2170MHz

1710MHz

1880MHz

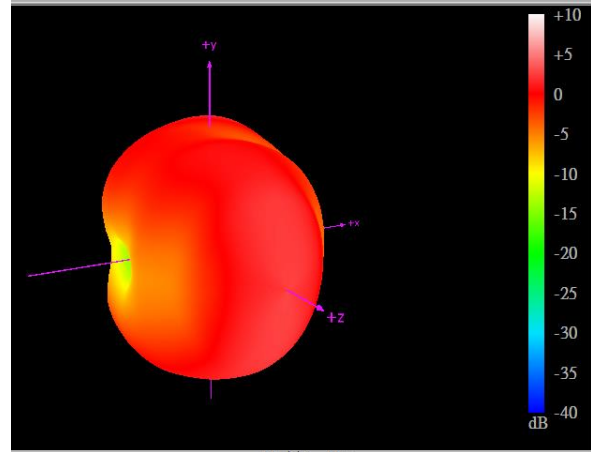
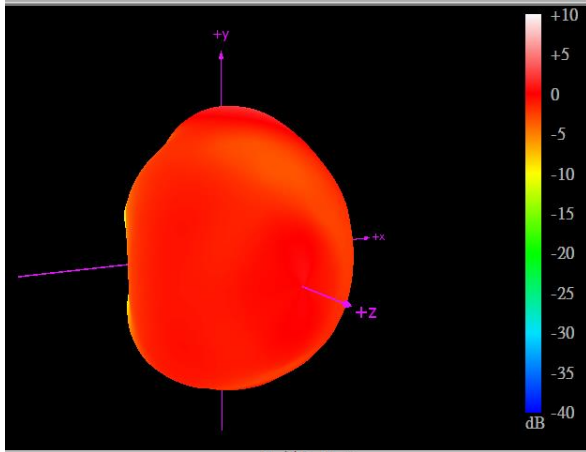

1990MHz

2170MHz

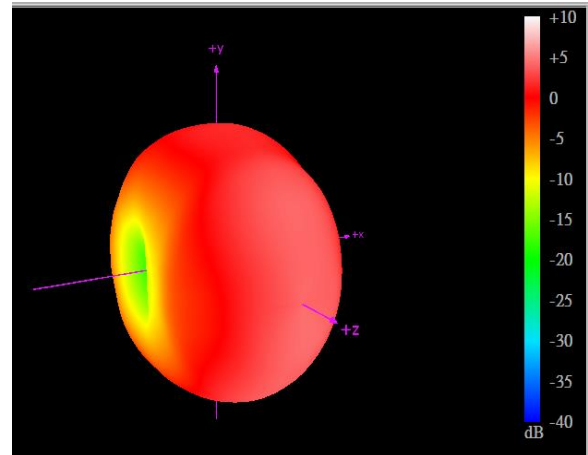
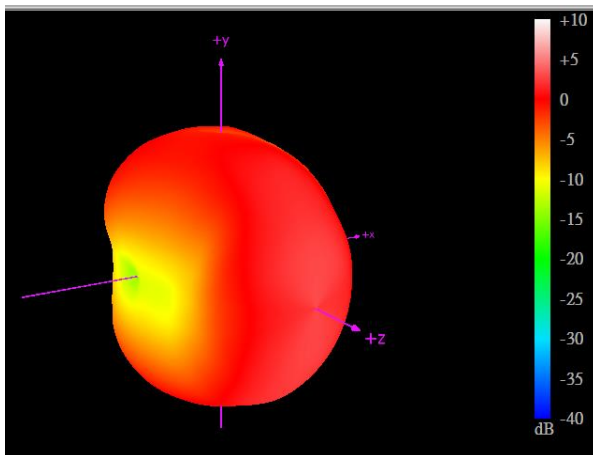

XY Plane

XZ Plane

YZ Plane

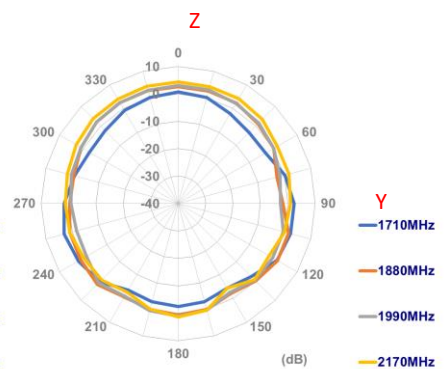
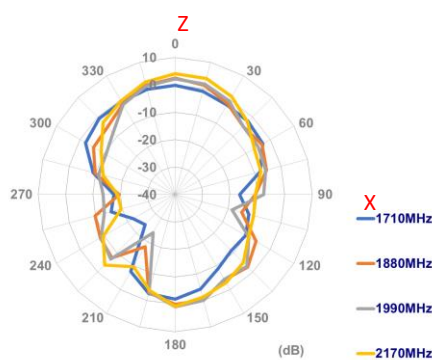
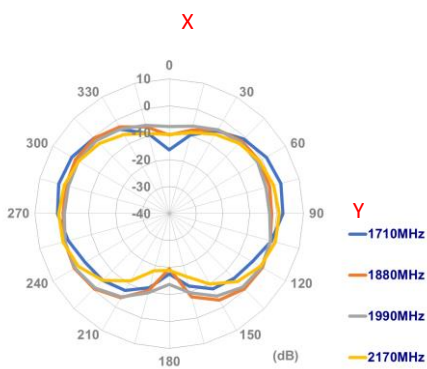

2300-2700MHz

2300MHz

2500MHz

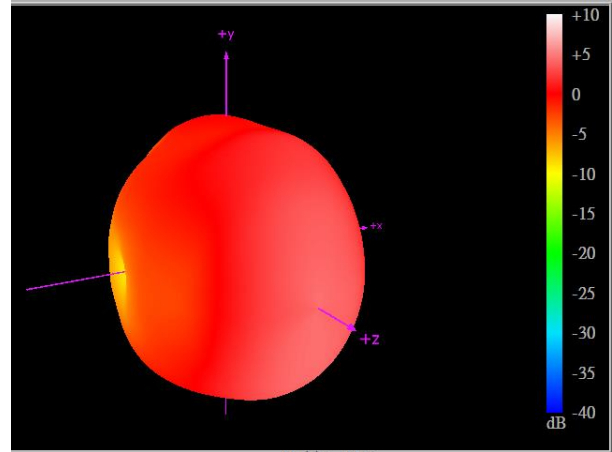
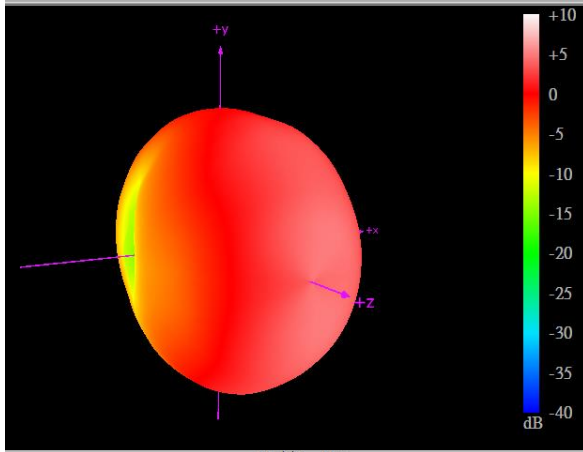

2570MHz

2700MHz

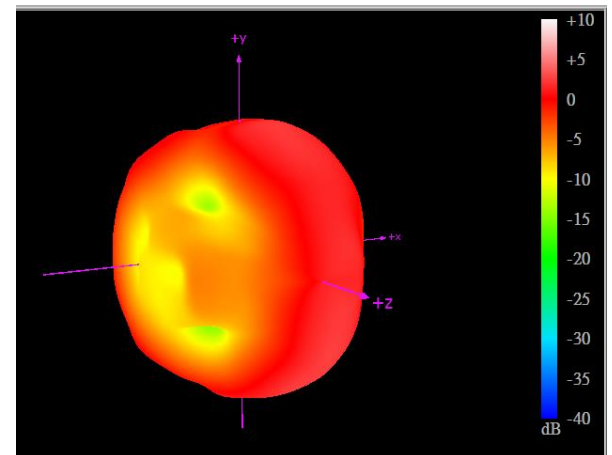
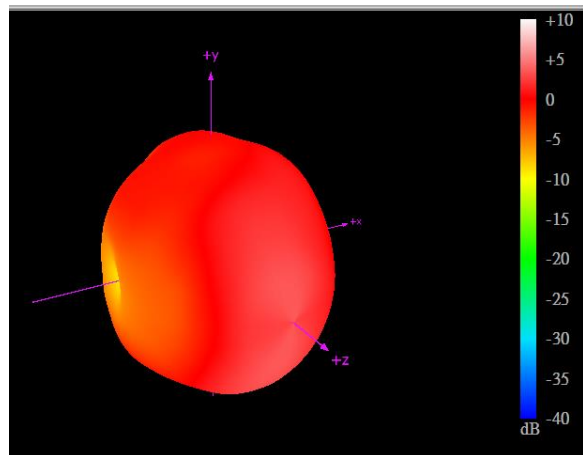

XY Plane

XZ Plane

YZ Plane

X

Z

Z

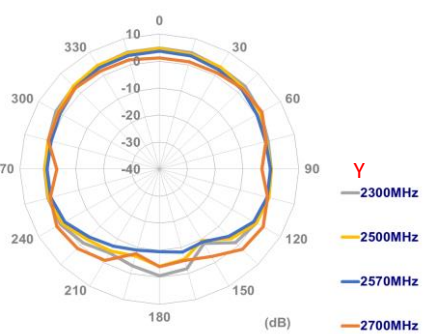
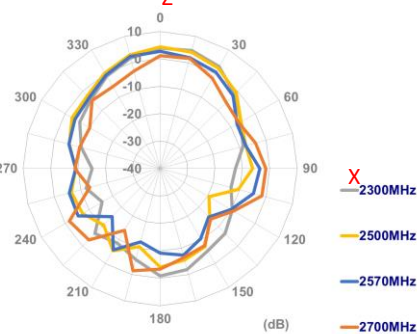
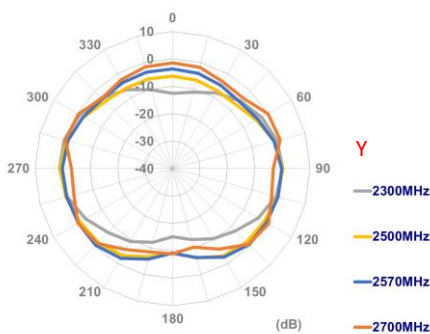

# 5. Mechanical Drawing (Units: mm)

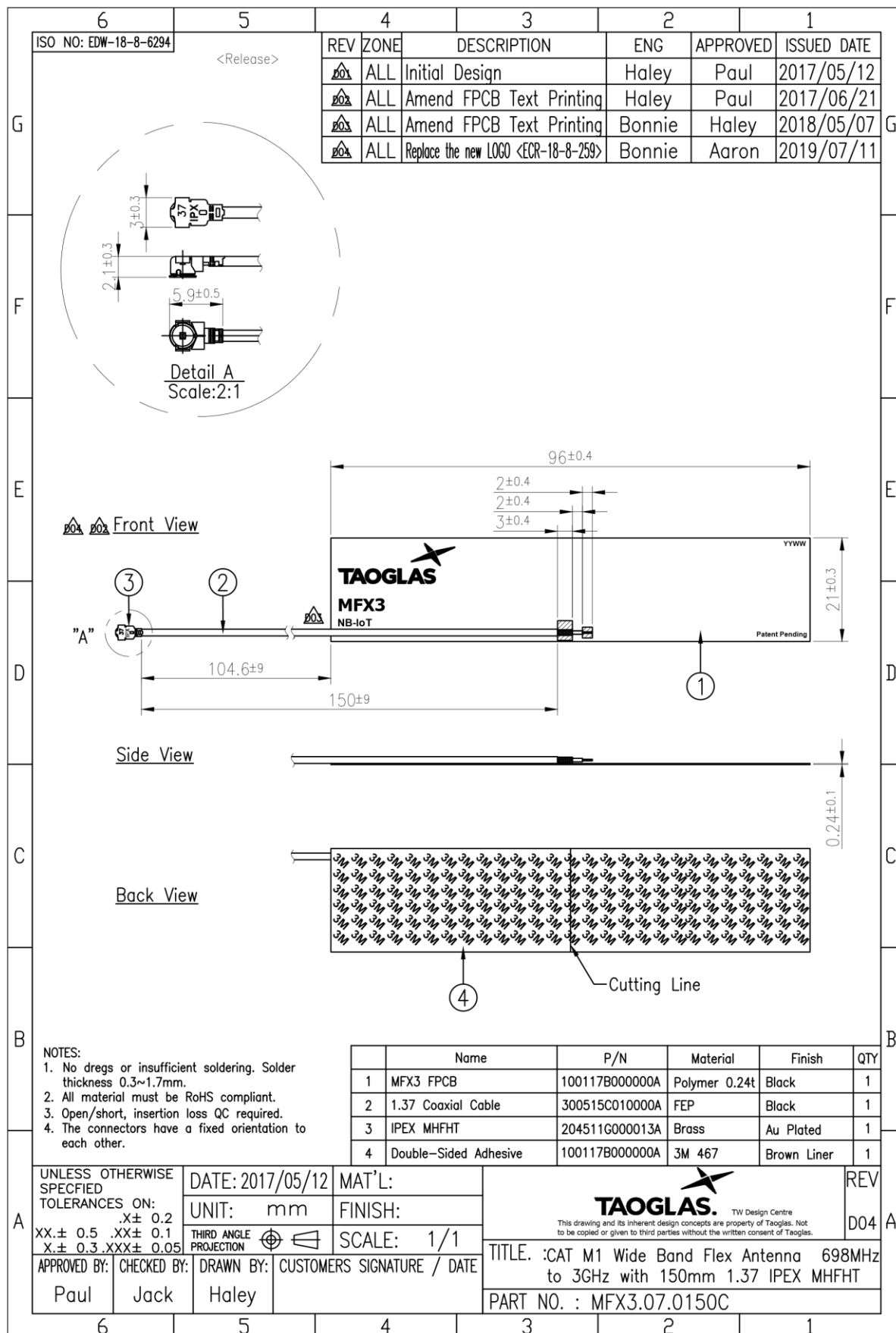

## 6. Packaging

100 pcs MFX3 per PE bag  
 PE Bag Dimensions - 350 x 100mm  
 Weight - 150g

1000 pcs MFX3 per large PE bag  
 Large PE Bag Dimensions - 460 x 280mm  
 Weight - 1500g

4000 pcs MFX3 per carton  
 Carton Dimensions - 320\*250\*230 mm  
 Weight - 6Kg

Pallet Dimensions 1200\*1000\*1350mm  
 60 Cartons per Pallet  
 12 Cartons per layer  
 5 Layers

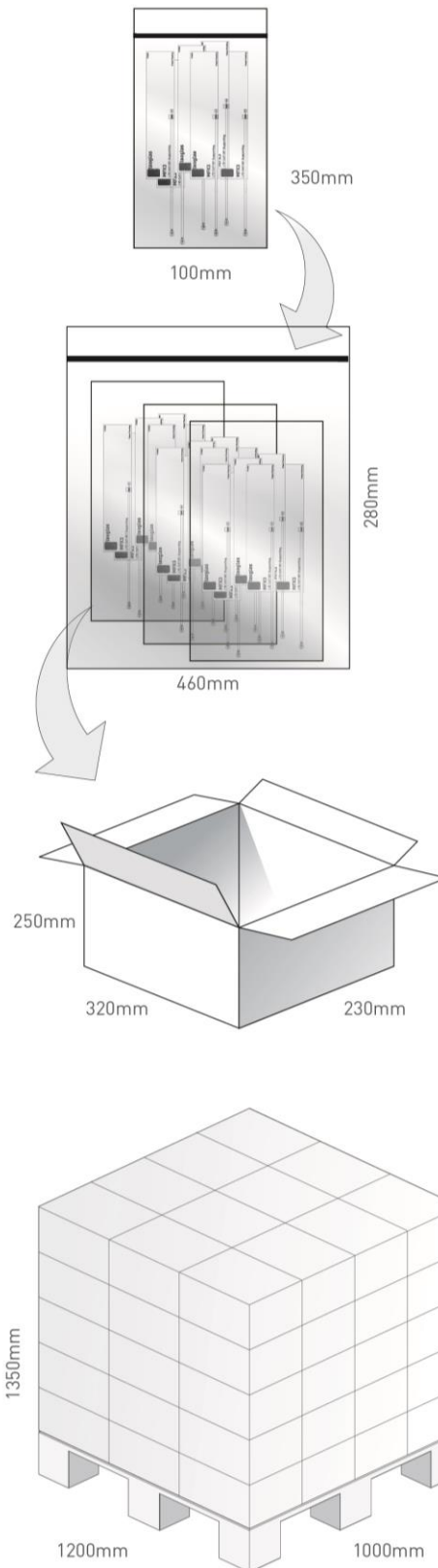

Changelog for the datasheet

**SPE-17-8-035 – MFX3.07.0150C**

<b>Revision: B</b>	
Date:	2020-05-18
Changes:	Updated Drawing and Photo ECR-18-8-259
Changes Made by:	Jack Conroy

**Previous Revisions**

<table border="1"> <tr> <td colspan="2"><b>Revision: A (Original First Release)</b></td> </tr> <tr> <td>Date:</td> <td>2017-08-10</td> </tr> <tr> <td>Notes:</td> <td></td> </tr> <tr> <td>Author:</td> <td>Jack Conroy</td> </tr> </table>	<b>Revision: A (Original First Release)</b>		Date:	2017-08-10	Notes:		Author:	Jack Conroy	
<b>Revision: A (Original First Release)</b>									
Date:	2017-08-10								
Notes:									
Author:	Jack Conroy								



**TAOGLAS**®

[www.taoglas.com](http://www.taoglas.com)





Компания «Океан Электроники» предлагает заключение долгосрочных отношений при поставках импортных электронных компонентов на взаимовыгодных условиях!

Наши преимущества:

- Поставка оригинальных импортных электронных компонентов напрямую с производств Америки, Европы и Азии, а так же с крупнейших складов мира;
- Широкая линейка поставок активных и пассивных импортных электронных компонентов (более 30 млн. наименований);
- Поставка сложных, дефицитных, либо снятых с производства позиций;
- Оперативные сроки поставки под заказ (от 5 рабочих дней);
- Экспресс доставка в любую точку России;
- Помощь Конструкторского Отдела и консультации квалифицированных инженеров;
- Техническая поддержка проекта, помощь в подборе аналогов, поставка прототипов;
- Поставка электронных компонентов под контролем ВП;
- Система менеджмента качества сертифицирована по Международному стандарту ISO 9001;
- При необходимости вся продукция военного и аэрокосмического назначения проходит испытания и сертификацию в лаборатории (по согласованию с заказчиком);
- Поставка специализированных компонентов военного и аэрокосмического уровня качества (Xilinx, Altera, Analog Devices, Intersil, Interpoint, Microsemi, Actel, Aeroflex, Peregrine, VPT, Syfer, Eurofarad, Texas Instruments, MS Kennedy, Miteq, Cobham, E2V, MA-COM, Hittite, Mini-Circuits, General Dynamics и др.);

Компания «Океан Электроники» является официальным дистрибьютором и эксклюзивным представителем в России одного из крупнейших производителей разъемов военного и аэрокосмического назначения «JONHON», а так же официальным дистрибьютором и эксклюзивным представителем в России производителя высокотехнологичных и надежных решений для передачи СВЧ сигналов «FORSTAR».



## JONHON

«JONHON» (основан в 1970 г.)

Разъемы специального, военного и аэрокосмического назначения:

(Применяются в военной, авиационной, аэрокосмической, морской, железнодорожной, горно- и нефтедобывающей отраслях промышленности)

«FORSTAR» (основан в 1998 г.)

ВЧ соединители, коаксиальные кабели, кабельные сборки и микроволновые компоненты:

(Применяются в телекоммуникациях гражданского и специального назначения, в средствах связи, РЛС, а так же военной, авиационной и аэрокосмической отраслях промышленности).



Телефон: 8 (812) 309-75-97 (многоканальный)

Факс: 8 (812) 320-03-32

Электронная почта: [ocean@oceanchips.ru](mailto:ocean@oceanchips.ru)

Web: <http://oceanchips.ru/>

Адрес: 198099, г. Санкт-Петербург, ул. Калинина, д. 2, корп. 4, лит. А