



Easy-to-Install
High Performance
Terminals

| Section | Page |
|--|-------------|
| Terminals, Kits and Tools | 5-79 |
| 3M™ Scotchlok™ Ring Tongues | 12-20 |
| 3M™ Scotchlok™ Multi-Stud Ring Tongues | 21 |
| 3M™ Scotchlok™ Compression Lug Ring Tongues..... | 22 |
| 3M™ Scotchlok™ Standard Forks | 23-26 |
| 3M™ Scotchlok™ Block Forks..... | 27-31 |
| 3M™ Scotchlok™ Flanged Block Forks | 32-34 |
| 3M™ Scotchlok™ Locking Forks | 34-39 |
| 3M™ Scotchlok™ Butt Connectors..... | 40-45 |
| 3M™ Scotchlok™ Female Disconnects..... | 45-55 |
| 3M™ Scotchlok™ Male Disconnects | 56-60 |
| 3M™ Scotchlok™ Piggy-Back Disconnects..... | 61 |
| 3M™ Scotchlok™ Adapters | 62 |
| 3M™ Scotchlok™ High Temperature Terminals | 63-66 |
| 3M™ Scotchlok™ Pin Terminals | 67-68 |
| 3M™ Scotchlok™ Closed End Connectors | 69 |
| 3M™ Scotchlok™ Parallel Connectors | 70 |
| 3M™ Highland™ Terminals | 71-77 |
| Kits and Tools..... | 78-79 |

Terminals, Kits and Tools

3M has been a leading supplier of terminals for more than 30 years. Our satisfied customers know our products for:

- Effective and reliable performance.
- Variety of types, sizes and materials that meet a broad application range, including the demands of temperature and weather.
- Design features assuring easy installation of 3M™ Products—positive and easy wire insertion, elimination of strand hang-ups and wire twisting, and easy insulation entry. These are a few of the characteristics that make the installer's job easier.

Customers can choose from two terminal families to meet their needs.

3M™ Scotchlok™ Terminals

Our premier line of terminals allow for various insulation types (such as heat shrink, nylon, vinyl, or non-insulated). Various barrel styles are available (such as butted, brazed, seamless, or interlocking barrel). Additionally, our premier terminals come in bottle or bulk packaging.

3M™ Highland™ Terminals

These terminals are either vinyl or nylon insulated with a butted seam. They come packaged in small quantities in reclosable plastic bags.

3M Terminals help accommodate the installer's needs.



Glossary of Terminals and Tools Terms

ADAPTERS

To interconnect two connectors already attached to wires.

BLOCK FORK

Same strength as the fork, but designed to use in terminal block because sides lie flat against barrier portion of terminal block.

BULLET STYLE SNAP PLUG

Similar advantages as disconnects. Gives reliable in-line connection because parts are made to have holding friction when joined. Usually for automotive use.

BUTT

Uses chamfered barrel ends to provide fast, easy wire insertion from both ends and a built-in wire stop for correct positioning. Must be crimped at both ends.

CLOSED-END

Used in situations requiring pigtail of two or more wires.

FLANGED FORK

Gives the benefit of both the block and locking forks. Stays secure should screw loosen.

FORK

Allows rapid connection of wire. Usually used on free-standing studs, because of wider tongues.

LOCKING FORK

The spring-like tongue locks in place around the stud even when mount screw is not tightened. Extra force is required to remove from stud.

PARALLEL

Similar to butt with overlapped wires and single crimp in center of connector. Used where space is limited.

PINS

For installation in compression blocks. Used in Europe for terminating stranded wire.

QUICK CONNECT (DISCONNECT)

Attached to mating part by tongue of female part slipping over male tab. Use of dents and rolled edges on female part provides excellent holding force while allowing easy and quick disconnect.

RING

The standard style of tongue. The safest and most reliable 3M terminal. It cannot be removed unless mounting screw is removed.

TAB

Uses mounting hole for rivet or screw.

TAP

No wire stripping is necessary, just lay wire in connector and crimp. Connection is made.

Standard Terminal Construction



3M™ Terminals provide a variety of design features assuring consistently effective, reliable performance and easy installation.

Please refer to the illustrations at the numbered locations for the attributes described below.

1. One-piece, burr-free construction provides maximum electrical conductivity. Electrical bright-tin plating gives maximum corrosion resistance. Annealing relieves stress points and provides maximum installed strength.
2. Barrel-to-pad transition design minimizes flexing and bending.
3. Open-end design permits visual inspection of wire location before and after crimping.
4. Maximum hold on wire comes from multiple “V” grooves in #22–4 AWG parts resulting in excellent holding power.
5. Injection molded insulations on terminals are the highest quality in the industry.
 - 221°F (105°C)* rated, tough, resistant electrical grade materials
 - Molding ensures consistent wall thickness for maximum reliability after crimping
 - Molding allows funnel barrel construction for easier installation
 - Molding offers the crimp ridge and non-slip ridge
6. Crimp ridge designed for positive location of tool on terminal barrel, resulting in few miscrimps.
7. Funnel barrel construction provides:
 - Positive, easy wire insertion
 - Virtually no hang-ups of wire strands
 - Wire twisting not necessary

*Products made in U.S.A. only.

8. Nylon-insulated terminals with grip feature a brass sleeve. Sleeve provides optimum grip on insulation, strain relief and vibration protection. Brass sleeve is recessed which provides excellent flash-over protection.

9. Non-slip ridge so tool slides to correct position for a proper crimp and better workmanship.

10. Beveled leading edge for easy wire insulation entry.

Barrel Styles

Non-Insulated Butted Seam



The most economical 3M terminal—used where special performance or installation characteristics are not needed. Beveled mouth facilitates wire insertion. Maximum temperature for bare terminals: 347°F (175°C).

Non-Insulated Brazed Seam



Beveled mouth facilitates wire insertion. Can be crimped anywhere on barrel surface. Silver brazed seam will not open under crimping pressure or operating stresses. Unlike butted seam parts, stranded wire cannot escape barrel confines during or after crimping. Maximum temperature for bare terminals: 347°F (175°C).

Vinyl Insulated Brazed and Butted Seams



Used where insulated barrel is necessary and desirable. Terminal consists of brazed or butted part with flared, rigid molded polyvinyl chloride sleeve securely attached and funneled for easy wire entry. Wire insulation positions itself against funnel portion of vinyl sleeve thus virtually eliminating strand hang-up. Crimping barrel and flared portion of sleeve provide excellent electrical contact plus mechanical stress relief at junction of insulation and barrel. Insulation has a non-slip ridge for ease of positioning crimping tool.

Nylon Insulated Butted Seam with Insulation Grip



Used where insulated barrel and positive insulation grip are necessary or desirable. Terminal consists of butted seam part with flared, seamless brass sleeve securely attached and covered with flared, molded nylon sleeve. Wire insulation positions itself against funnel portion of brass sleeve. Crimping barrel and flared portion of sleeve provide excellent electrical contact plus mechanical stress relief at junction of insulation and barrel. Positioning crimp tool is nearly mistake proof due to a “step” in nylon insulation. Industry standard color coding indicates wire range. Insulators are rated at a continuous operating temperature range from -40°F to 221°F (-40°C to 105°C)*.

UL Listed and CSA Certified for 600V building wire and 1000V signs and lighting fixtures (luminaries)*.

Installation Procedure

Funnel Barrel Feature provides an excellent electrical and mechanical connection.

- Funnel design guides wire into position.



- No wire strand hang-up as the wire is inserted, giving a fast, positive installation.



- Wire is in place, ready for crimping.



For maximum crimping performance, barrel of connector must be properly indexed in the crimp tool station.

*Products made in U.S.A. only.

Correct crimping is important to assure a strong connection.



Insulated Terminals and Connectors:



Non-Insulated Terminals and Connectors:

Indent should be opposite the barrel seam.

Heat Shrink Terminals, Connectors and Disconnects

3M™ Heat Shrink Pre-insulated Terminals, Connectors and Disconnects protect against the most challenging of environments, making the best moisture protection available. They offer several advantages over conventional unsealed products.

Corrosion Resistance

The adhesive-lined heat shrink material, when properly crimped and shrunk, provides a seal resistant to water, salt, steam and other related contaminants.

Improved Mechanical Performance

The adhesive-lined heat shrink tubing adheres, when shrunk, to both the connector and the wire insulation providing improved pullout strength and strain relief.

Durable Heat Shrink Tubing

Tough heat shrink tubing effectively resists abrasion, scoring, cut-through, and the effects of long-term aging.

Versatile and Easy to Use

3M heat shrink terminals, splices and disconnects are available in wire sizes 22–10 AWG and can be installed easily with a recommended tool and heat source. The connectors are color-coded for wire range identification and the transparent tubing allows for visual inspection.

Application Procedure for Heat Shrink Products:

1. Strip wires to appropriate length as indicated on package label.



2. Insert wire into terminal and crimp with correct station of a recommended tool.



3. Apply heat with a recommended heat source.



High Temperature Terminals and Connectors

3M™ High Temperature Terminals and Connectors are constructed of steel with a nickel plating. Their temperature rating for continuous use at 900°F (482°C) makes them ideal for use in ovens, motors, light fixtures and other applications where other connectors could corrode or melt.

There is no applicable UL or CSA standard for high temperature steel parts.

Standard Crimp Terminal and Connector Specifications

Materials

Crimp terminals and connectors are to be burr-free, annealed and bright-tin plated ETP copper. Barrels shall be 0.25" long with brazed seams where specified. Insulation grip sleeves are to be tin-plated brass and attached securely to the barrel. Terminal insulators are to be molded polyvinyl chloride or nylon, UL Listed and CSA Certified for 600V in building wire and 1000V in signs and lighting fixtures (luminaries)*. Connector insulators are to be extruded polyvinyl chloride or nylon with a temperature rating of 221°F (105°C)*.

Construction

Most insulated terminals are to have funnel entry construction* to prevent strand hang-up and a crimp ridge for proper tool location. Nylon insulated terminals and connectors are to have butted seam barrels with insulation grip sleeves. Terminal barrels are to have multiple "V" grooves for maximum conductor retention.

*Products made in U.S.A. only.

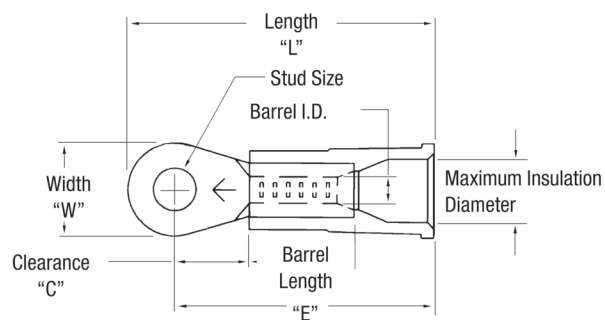

Note: All dimensions are measured in inches.

FREQUENTLY ASKED QUESTIONS

What does the insulation grip do?

The insulation grip provides a "second" crimp on the wire insulation providing additional wire strain relief. It's excellent for high vibration applications.

What's the difference between insulated and fully insulated disconnects?

Insulated disconnects have barrel insulation only and fully insulated disconnects are insulated from the barrel to the receptacle/tab.

What temperatures do 3M terminals withstand?

Non-insulated 3M terminals withstand temperatures up to 347°F (175°C). Insulated 3M terminals withstand temperatures up to 221°F (105°C).

3M™ Terminal Numbering System

| 3M Identity | Code/Barrel Style | Wire Size Code (AWG) | – | Stud, Tab, or Bullet Size | Tongue Code | Product Availability** |
|-------------|-----------------------------|----------------------|--------------------------------------|---------------------------|--------------------------------|---|
| M | No Code = Bare Brazed | 24 = 26–24 (yellow) | – | (STUD) | F = Fork | All bottle (X) or bag (Q) package terminals in this catalog are available (in the packaging quantity indicated) from local distributor stocks. All bulk (K) packaged terminals are available in full cartons only, and may require a three to five week order lead time from the factory. |
| | A = No Barrel (adapter) | 20 = 26–20 (yellow) | | 0 = 0 | FB = Fork, Block | |
| | I = Double Wall w/interlock | 18 = 22–18 (red) | | 2 = 2 | FBHT = Fork, Block, High Temp. | |
| | N = Nylon Brazed | 14 = 16–14 (blue) | | 4 = 4 | FFB = Fork, Flanged, Block | |
| | NG = Nylon w/ Grip | 10 = 12–10 (yellow) | | 6 = 6 | FHT = Fork, High Temp. | |
| | NHU = Nylon/Butted | 8 = 8 (red) | | 8 = 8 | FL = Fork, Locking | |
| | w/ Heat Shrink Over Top | 6 = 6 (blue) | | 10 = 10 | R = Ring | |
| | NU = Nylon/Butted | 4 = 4 (yellow) | | 12 = 1/2" | RHD = Ring, Heavy Duty | |
| | U = Bare/Butted | | | 14 = 1/4" | RHT = Ring, High Temp. | |
| | V = Vinyl/Brazed | | | 38 = 3/8" | /S = Short or Small | |
| | VA = Vinyl Adapter | | | 516 = 5/16" | /L = Large or Long | |
| | VU = Vinyl/Butted | | | 610 = 6, 8, 10 | R/Flag = Ring, Flag | |
| | | | | | BC = Butt Connector | |
| | | | | | CEC = Closed End Connector | |
| | | | | | P = Pin Connector | |
| | | | | | PC = Parallel Connector | |
| | | | | | BCM = Butt Connector | |
| | | | | | Moisture Res. | |
| | | | | | CEC/ST = Closed End Connector | |
| | | | | | Disconnect | |
| | | | | | DF = Female | |
| | | | | | DFHT = Female, High Temp. | |
| | | | | | DFI = Female, Fully Insulated | |
| | | | | | DM = Male | |
| | | | DMF = Male, Female | | | |
| | | | DMHT = Male, High Temp. | | | |
| | | | DMI = Male, Fully Insulated | | | |
| | | | DF/Flag = Female Flag Adapter | | | |
| | | | D = Disconnects | | | |
| | | | F = Female | | | |
| | | | FFI = Double Female, Fully Insulated | | | |
| | | | M = Male | | | |
| | | | MMI = Double Male, Fully Insulated | | | |
| | | | MMF = Double Male, Female | | | |
| | | | MFM = Male, Female, Male, Stacking | | | |
| | | | RR = Ring Rectangular Tongue | | | |
| | | | Fuse = Fuse Adapter Clip | | | |

* A dash (–) separates the wire size code from the stud, tab or bullet size code.

** Denotes product packaging. Packaging of 3M Scotchlok™ terminals should be specified by using the appropriate terminal part number. Suffix letters are indicated within each product number. (See "Product Number" heading in ordering information charts.)

Product numbers ending with "-A" are made in Taiwan.

Note: Contact your local distributor or 3M sales office for price and delivery information.

Map of Numbering System

Example:

Catalog Number: MNG18-4 FB/SK

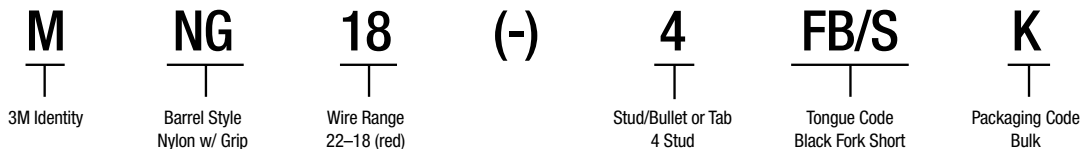

Insulator Color Coding

Yellow (26-24 AWG) Red (22-18 AWG) Blue (16-14 AWG) Yellow (12-10 AWG) Red (8 AWG) Blue (6 AWG) Yellow (4 AWG)

*Product number ending in X = bottle; product number ending with K = bulk; product number ending with Q = bag

3M™ Terminal Stud Size Chart

| | Stud Size | | | | 3M Terminal Hole Diameter |
|------|---|---------------------|------|---|---------------------------|
| | US/Inches | Diameter | | OUS/Metric | |
| #2 |  | 0.086" (2,144 mm) | M2 |  | 2,0 mm (0.080") |
| #4 |  | 0.112" (2,844 mm) | M2,5 |  | 2,5 mm (0.100") |
| #5 |  | 0.125" (3,175 mm) | M3 |  | 3,0 mm (0.120") |
| #6 |  | 0.138" (3,505 mm) | M3,5 |  | 3,5 mm (0.140") |
| #8 |  | 0.164" (4,166 mm) | M4 |  | 4,0 mm (0.176") |
| #10 |  | 0.190" (4,826 mm) | M5 |  | 5,0 mm (0.20") |
| 1/4 |  | 0.250" (6,350 mm) | M6 |  | 6,0 mm (0.24") |
| 5/16 |  | 0.3125" (7,938 mm) | M8 |  | 8,0 mm (0.32") |
| 3/8 |  | 0.375" (9,525 mm) | M10 |  | 10,0 mm (0.40") |
| 7/16 |  | 0.4375" (11,113 mm) | M10 |  | 10,0 mm (0.48") |
| 1/2 |  | 0.500" (12,700 mm) | M12 |  | 12,0 mm (0.48") |
| 5/8 |  | 0.625" (15,875 mm) | M16 |  | 16,0 mm (0.64") |
| 3/4 |  | 0.750" (19,050 mm) | M18 |  | 18,0 mm (0.72") |

Ref: ISO 263-1973 for inch stud sizes and ISO 262-1973 for metric stud sizes.

American Wire Gauge

| Size | Inches | Millimeters | Size | Inches | Millimeters | Size | Inches | Millimeters |
|------|--------|-------------|------|--------|-------------|------|--------|-------------|
| 4/0 | 0.4600 | 11,684 | 4 | 0.2043 | 5,189 | 16 | 0.0508 | 1,290 |
| 3/0 | 0.4096 | 10,040 | 6 | 0.1620 | 4,115 | 18 | 0.0403 | 1,024 |
| 2/0 | 0.3648 | 9,266 | 8 | 0.1285 | 3,264 | 20 | 0.0320 | 0,813 |
| 1/0 | 0.3249 | 8,253 | 10 | 0.1019 | 2,588 | 22 | 0.0253 | 0,643 |
| 1 | 0.2893 | 7,347 | 12 | 0.0808 | 2,052 | 24 | 0.0201 | 0,511 |
| 2 | 0.2576 | 6,543 | 14 | 0.0641 | 1,628 | 26 | 0.0159 | 0,404 |

Heat Shrink Brazed Seam Ring Tongues

Terminal Type Ring
 Terminal Style Standard
 Insulation Material Heat Shrink
 Barrel Style Brazed
 RoHS 2011/65/EU Yes

Manufacturing Origin



| Order No. | UPC | Conductor Size | Stud Size | (W) | (C) | (L) | (E) | Thickness | Barrel I.D. | Terminals per Carton | Terminals per Case |
|--------------|--------------|----------------|-----------|-------|-------|-------|-------|-----------|-------------|----------------------|--------------------|
| MH18-6R/LK | 054007-06345 | 22 - 18 AWG | 6 | 0.31" | 0.15" | 1.00" | 0.84" | 0.030" | 0.070" | - | 250 |
| MH18-6R/LX | 051128-58910 | 22 - 18 AWG | 6 | 0.31" | 0.15" | 1.00" | 0.84" | 0.030" | 0.070" | 25 | 125 |
| MH18-8R/LK | 054007-06349 | 22 - 18 AWG | 8 | 0.31" | 0.18" | 1.00" | 0.84" | 0.030" | 0.070" | - | 250 |
| MH18-8R/LX | 051128-58912 | 22 - 18 AWG | 8 | 0.31" | 0.18" | 1.00" | 0.84" | 0.030" | 0.070" | 25 | 125 |
| MH18-10R/LK | 054007-06351 | 22 - 18 AWG | 10 | 0.31" | 0.20" | 1.00" | 0.84" | 0.030" | 0.070" | - | 250 |
| MH18-10R/LX | 051128-58914 | 22 - 18 AWG | 10 | 0.31" | 0.20" | 1.00" | 0.84" | 0.030" | 0.070" | 25 | 125 |
| MH14-6R/LK | 054007-06321 | 16 - 14 AWG | 6 | 0.31" | 0.15" | 1.00" | 0.84" | 0.030" | 0.090" | - | 250 |
| MH14-6R/LX | 051128-58898 | 16 - 14 AWG | 6 | 0.31" | 0.15" | 1.00" | 0.84" | 0.030" | 0.090" | 25 | 125 |
| MH14-8R/LK | 054007-06325 | 16 - 14 AWG | 8 | 0.31" | 0.18" | 1.00" | 0.84" | 0.030" | 0.090" | - | 250 |
| MH14-8R/LX | 051128-58900 | 16 - 14 AWG | 8 | 0.31" | 0.18" | 1.00" | 0.84" | 0.030" | 0.090" | 25 | 125 |
| MH14-10R/LK | 054007-06327 | 16 - 14 AWG | 10 | 0.31" | 0.20" | 1.00" | 0.84" | 0.030" | 0.090" | - | 250 |
| MH14-10R/LX | 051128-58901 | 16 - 14 AWG | 10 | 0.31" | 0.20" | 1.00" | 0.84" | 0.030" | 0.090" | 25 | 125 |
| MH14-14R/SK | 054007-06331 | 16 - 14 AWG | 1/4" | 0.47" | 0.26" | 1.10" | 0.86" | 0.030" | 0.090" | - | 250 |
| MH14-14R/SX | 051128-58903 | 16 - 14 AWG | 1/4" | 0.47" | 0.26" | 1.10" | 0.86" | 0.030" | 0.090" | 25 | 125 |
| MH14-516R/SK | 054007-06337 | 16 - 14 AWG | 5/16" | 0.47" | 0.33" | 1.10" | 0.86" | 0.030" | 0.090" | - | 250 |
| MH14-516R/SX | 051128-58906 | 16 - 14 AWG | 5/16" | 0.47" | 0.33" | 1.10" | 0.86" | 0.030" | 0.090" | 25 | 125 |
| MH14-38RK | 054007-06335 | 16 - 14 AWG | 3/8" | 0.56" | 0.28" | 1.10" | 0.87" | 0.030" | 0.090" | - | 250 |
| MH14-38RX | 051128-58905 | 16 - 14 AWG | 3/8" | 0.56" | 0.28" | 1.10" | 0.87" | 0.030" | 0.090" | 25 | 125 |
| MH10-8RK | 054007-06303 | 12 - 10 AWG | 8 | 0.38" | 0.19" | 1.10" | 0.91" | 0.040" | 0.145" | - | 250 |
| MH10-8RX | 051128-58888 | 12 - 10 AWG | 8 | 0.38" | 0.19" | 1.10" | 0.91" | 0.040" | 0.145" | 25 | 125 |
| MH10-10RK | 054007-06306 | 12 - 10 AWG | 10 | 0.38" | 0.21" | 1.10" | 0.90" | 0.040" | 0.145" | - | 250 |
| MH10-10RX | 051128-58890 | 12 - 10 AWG | 10 | 0.38" | 0.21" | 1.10" | 0.90" | 0.040" | 0.145" | 25 | 125 |
| MH10-14RK | 054007-06359 | 12 - 10 AWG | 1/4" | 0.59" | 0.29" | 1.20" | 0.90" | 0.040" | 0.145" | - | 250 |
| MH10-14RX | 051128-58892 | 12 - 10 AWG | 1/4" | 0.59" | 0.29" | 1.20" | 0.90" | 0.040" | 0.145" | 25 | 125 |
| MH10-38RK | 054007-06313 | 12 - 10 AWG | 3/8" | 0.59" | 0.29" | 1.20" | 0.90" | 0.040" | 0.145" | - | 250 |
| MH10-38RX | 051128-58894 | 12 - 10 AWG | 3/8" | 0.59" | 0.29" | 1.20" | 0.90" | 0.040" | 0.145" | 25 | 125 |

Nylon Insulated with Insulation Grip Ring Tongues

Terminal Type Ring
 Terminal Style Standard
 Insulation Material Nylon with Insulation Grip
 Barrel Style Butted
 RoHS 2011/65/EU Yes

Agency Approval



Manufacturing Origin



| Order No. | UPC | Conductor Size | Stud Size | (W) | (C) | (L) | (E) | Thickness | Barrel I.D. | Max. Insul. Dia. | Terminals per Carton | Terminals per Case |
|---------------|--------------|----------------|-----------|-------|-------|-------|-------|-----------|-------------|------------------|----------------------|--------------------|
| MNG18-4R/SK | 054007-01062 | 22 - 18 AWG | 4 | 0.25" | 0.22" | 0.79" | 0.66" | 0.030" | 0.070" | 0.145" | - | 1000 |
| MNG18-4R/SX | 051128-58943 | 22 - 18 AWG | 4 | 0.25" | 0.22" | 0.79" | 0.66" | 0.030" | 0.070" | 0.145" | 100 | 500 |
| MNG18-6R/SK | 054007-16163 | 22 - 18 AWG | 6 | 0.25" | 0.22" | 0.79" | 0.66" | 0.030" | 0.070" | 0.145" | - | 1000 |
| MNG18-6R/SX | 051128-58642 | 22 - 18 AWG | 6 | 0.25" | 0.22" | 0.79" | 0.66" | 0.030" | 0.070" | 0.145" | 100 | 500 |
| MNG18-8R/LK | 054007-01069 | 22 - 18 AWG | 8 | 0.31" | 0.33" | 0.92" | 0.77" | 0.030" | 0.070" | 0.145" | - | 1000 |
| MNG18-8R/LX | 051128-58644 | 22 - 18 AWG | 8 | 0.31" | 0.33" | 0.92" | 0.77" | 0.030" | 0.070" | 0.145" | 100 | 500 |
| MNG18-10R/LK | 054007-01071 | 22 - 18 AWG | 10 | 0.31" | 0.33" | 0.92" | 0.77" | 0.030" | 0.070" | 0.145" | - | 1000 |
| MNG18-10R/LX | 051128-58643 | 22 - 18 AWG | 10 | 0.31" | 0.33" | 0.92" | 0.77" | 0.030" | 0.070" | 0.145" | 100 | 500 |
| MNG18-14R/SK | 054007-01072 | 22 - 18 AWG | 1/4" | 0.47" | 0.40" | 1.07" | 0.84" | 0.030" | 0.070" | 0.145" | - | 1000 |
| MNG18-14R/SX | 051128-58944 | 22 - 18 AWG | 1/4" | 0.47" | 0.40" | 1.07" | 0.84" | 0.030" | 0.070" | 0.145" | 100 | 500 |
| MNG18-516R/SX | 051128-58945 | 22 - 18 AWG | 5/16" | 0.47" | 0.40" | 1.07" | 0.84" | 0.030" | 0.070" | 0.145" | 100 | 500 |
| MNG18-38RK | 054007-01076 | 22 - 18 AWG | 3/8" | 0.56" | 0.40" | 1.12" | 0.84" | 0.030" | 0.070" | 0.145" | - | 1000 |
| MNG18-38RX | 051128-58946 | 22 - 18 AWG | 3/8" | 0.56" | 0.40" | 1.12" | 0.84" | 0.030" | 0.070" | 0.145" | 100 | 500 |
| MNG14-4R/SX | 051128-58962 | 16 - 14 AWG | 4 | 0.25" | 0.22" | 0.81" | 0.68" | 0.030" | 0.090" | 0.170" | 100 | 500 |
| MNG14-6R/SK | 054007-01430 | 16 - 14 AWG | 6 | 0.25" | 0.22" | 0.81" | 0.68" | 0.030" | 0.090" | 0.170" | - | 1000 |
| MNG14-6R/SX | 051128-58661 | 16 - 14 AWG | 6 | 0.25" | 0.22" | 0.81" | 0.68" | 0.030" | 0.090" | 0.170" | 100 | 500 |
| MNG14-8RK | 054007-01434 | 16 - 14 AWG | 8 | 0.33" | 0.29" | 0.91" | 0.75" | 0.030" | 0.090" | 0.170" | - | 1000 |
| MNG14-8RX | 051128-58964 | 16 - 14 AWG | 8 | 0.33" | 0.29" | 0.91" | 0.75" | 0.030" | 0.090" | 0.170" | 100 | 500 |
| MNG14-8R/SK | 054007-01433 | 16 - 14 AWG | 8 | 0.25" | 0.22" | 0.81" | 0.68" | 0.030" | 0.090" | 0.170" | - | 1000 |
| MNG14-8R/SX | 051128-58963 | 16 - 14 AWG | 8 | 0.25" | 0.22" | 0.81" | 0.68" | 0.030" | 0.090" | 0.170" | 100 | 500 |
| MNG14-8R/LK | 054007-01435 | 16 - 14 AWG | 8 | 0.31" | 0.33" | 0.94" | 0.79" | 0.030" | 0.090" | 0.170" | - | 1000 |
| MNG14-8R/LX | 051128-58704 | 16 - 14 AWG | 8 | 0.31" | 0.33" | 0.94" | 0.79" | 0.030" | 0.090" | 0.170" | 100 | 500 |
| MNG14-10RK | 054007-14150 | 16 - 14 AWG | 10 | 0.33" | 0.29" | 0.91" | 0.75" | 0.030" | 0.090" | 0.170" | - | 1000 |
| MNG14-10RX | 051128-58965 | 16 - 14 AWG | 10 | 0.33" | 0.29" | 0.91" | 0.75" | 0.030" | 0.090" | 0.170" | 100 | 500 |
| MNG14-10R/LX | 051128-58662 | 16 - 14 AWG | 10 | 0.31" | 0.33" | 0.94" | 0.79" | 0.030" | 0.090" | 0.170" | 100 | 500 |
| MNG14-10R/LK | 054007-01437 | 16 - 14 AWG | 10 | 0.31" | 0.33" | 0.94" | 0.79" | 0.030" | 0.090" | 0.170" | - | 1000 |
| MNG14-14R/SK | 054007-01438 | 16 - 14 AWG | 1/4" | 0.47" | 0.40" | 1.09" | 0.86" | 0.030" | 0.090" | 0.170" | - | 1000 |
| MNG14-14R/SX | 051128-58663 | 16 - 14 AWG | 1/4" | 0.47" | 0.40" | 1.09" | 0.86" | 0.030" | 0.090" | 0.170" | 100 | 500 |
| MNG14-516R/SK | 054007-01440 | 16 - 14 AWG | 5/16" | 0.47" | 0.40" | 1.09" | 0.86" | 0.030" | 0.090" | 0.170" | - | 1000 |
| MNG14-516R/SX | 051128-58967 | 16 - 14 AWG | 5/16" | 0.47" | 0.40" | 1.09" | 0.86" | 0.030" | 0.090" | 0.170" | 100 | 500 |
| MNG14-38RK | 054007-01442 | 16 - 14 AWG | 3/8" | 0.56" | 0.40" | 1.14" | 0.86" | 0.030" | 0.090" | 0.170" | - | 1000 |
| MNG14-38RX | 051128-58968 | 16 - 14 AWG | 3/8" | 0.56" | 0.40" | 1.14" | 0.86" | 0.030" | 0.090" | 0.170" | 100 | 500 |
| MNG10-4R/SK | 054007-01932 | 12 - 10 AWG | 4 | 0.28" | 0.29" | 0.98" | 0.84" | 0.040" | 0.135" | 0.250" | - | 500 |
| MNG10-6RK | 054007-01934 | 12 - 10 AWG | 6 | 0.38" | 0.29" | 1.03" | 0.84" | 0.040" | 0.135" | 0.250" | - | 500 |

3M™ Scotchlok™ Ring Tongues

Nylon Insulated with Insulation Grip Ring Tongues (continued)

| Order No. | UPC | Conductor Size | Stud Size | (W) | (C) | (L) | (E) | Thickness | Barrel I.D. | Max. Insul. Dia. | Terminals per Carton | Terminals per Case |
|---------------|--------------|----------------|-----------|-------|-------|-------|-------|-----------|-------------|------------------|----------------------|--------------------|
| MNG10-6RX | 051128-58684 | 12 - 10 AWG | 6 | 0.38" | 0.29" | 1.03" | 0.84" | 0.040" | 0.135" | 0.250" | 50 | 500 |
| MNG10-8RK | 054007-01936 | 12 - 10 AWG | 8 | 0.38" | 0.29" | 1.03" | 0.84" | 0.040" | 0.135" | 0.250" | - | 500 |
| MNG10-8RX | 051128-58685 | 12 - 10 AWG | 8 | 0.38" | 0.29" | 1.03" | 0.84" | 0.040" | 0.135" | 0.250" | 50 | 500 |
| MNG10-10RK | 054007-01937 | 12 - 10 AWG | 10 | 0.38" | 0.29" | 1.03" | 0.84" | 0.040" | 0.135" | 0.250" | - | 500 |
| MNG10-10RX | 051128-58686 | 12 - 10 AWG | 10 | 0.38" | 0.29" | 1.03" | 0.84" | 0.040" | 0.135" | 0.250" | 50 | 500 |
| MNG10-14R/SK | 054007-01938 | 12 - 10 AWG | 1/4" | 0.53" | 0.44" | 1.26" | 0.99" | 0.040" | 0.135" | 0.250" | - | 500 |
| MNG10-14R/SX | 051128-58715 | 12 - 10 AWG | 1/4" | 0.53" | 0.44" | 1.26" | 0.99" | 0.040" | 0.135" | 0.250" | 50 | 500 |
| MNG10-516R/SK | 054007-01940 | 12 - 10 AWG | 5/16" | 0.53" | 0.44" | 1.26" | 0.99" | 0.040" | 0.135" | 0.250" | - | 500 |
| MNG10-516R/SX | 051128-58984 | 12 - 10 AWG | 5/16" | 0.53" | 0.44" | 1.26" | 0.99" | 0.040" | 0.135" | 0.250" | 50 | 500 |
| MNG10-38R/SK | 054007-01942 | 12 - 10 AWG | 3/8" | 0.54" | 0.44" | 1.26" | 0.99" | 0.040" | 0.135" | 0.250" | - | 500 |
| MNG10-38R/SX | 051128-58985 | 12 - 10 AWG | 3/8" | 0.54" | 0.44" | 1.26" | 0.99" | 0.040" | 0.135" | 0.250" | 50 | 500 |

Nylon Insulated Braze Seam Ring Tongues

Terminal Type Ring
 Terminal Style Standard
 Insulation Material Nylon
 Barrel Style Braze
 RoHS 2011/65/EU Yes



Agency Approval

Except for MN24 Rings

Manufacturing Origin

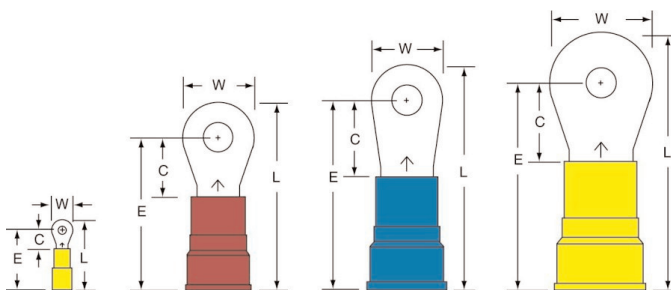

| Order No. | UPC | Conductor Size | Stud Size | (W) | (C) | (L) | (E) | Thickness | Barrel I.D. | Max. Insul. Dia. | Terminals per Carton | Terminals per Case |
|------------|--------------|----------------|-----------|-------|-------|-------|-------|-----------|-------------|------------------|----------------------|--------------------|
| MN4-10RK | 054007-08277 | 4 AWG | 10 | 0.68" | 0.53" | 1.74" | 1.41" | 0.075" | 0.280" | 0.515" | - | 200 |
| MN4-12R/SK | 054007-08281 | 4 AWG | 1/2" | 0.68" | 0.53" | 1.74" | 1.41" | 0.075" | 0.280" | 0.515" | - | 200 |
| MN4-14RK | 054007-08278 | 4 AWG | 1/4" | 0.68" | 0.53" | 1.74" | 1.41" | 0.075" | 0.280" | 0.515" | - | 200 |
| MN4-38RK | 054007-08280 | 4 AWG | 3/8" | 0.68" | 0.53" | 1.74" | 1.41" | 0.075" | 0.280" | 0.515" | - | 200 |
| MN4-38RX | 051128-59002 | 4 AWG | 3/8" | 0.68" | 0.53" | 1.74" | 1.41" | 0.075" | 0.280" | 0.515" | 10 | 100 |
| MN4-516RK | 054007-08279 | 4 AWG | 5/16" | 0.68" | 0.53" | 1.74" | 1.41" | 0.075" | 0.280" | 0.515" | - | 200 |
| MN6-10R/SK | 054007-08272 | 6 AWG | 10 | 0.47" | 0.52" | 1.50" | 1.27" | 0.050" | 0.250" | 0.440" | - | 200 |
| MN6-12R/SK | 054007-08276 | 6 AWG | 1/2" | 0.81" | 0.63" | 1.78" | 1.38" | 0.050" | 0.250" | 0.440" | - | 200 |
| MN6-14R/SX | 051128-58637 | 6 AWG | 1/4" | 0.47" | 0.52" | 1.50" | 1.27" | 0.050" | 0.250" | 0.440" | 10 | 100 |
| MN6-14R/SK | 054007-08273 | 6 AWG | 1/4" | 0.47" | 0.52" | 1.50" | 1.27" | 0.050" | 0.250" | 0.440" | - | 200 |
| MN6-38RK | 054007-08275 | 6 AWG | 3/8" | 0.63" | 0.52" | 1.58" | 1.27" | 0.050" | 0.250" | 0.440" | - | 200 |
| MN6-38RX | 051128-58878 | 6 AWG | 3/8" | 0.63" | 0.52" | 1.58" | 1.27" | 0.050" | 0.250" | 0.440" | 10 | 100 |
| MN6-516RK | 054007-08274 | 6 AWG | 5/16" | 0.63" | 0.52" | 1.58" | 1.27" | 0.050" | 0.250" | 0.440" | - | 200 |
| MN8-10R/SK | 054007-08267 | 8 AWG | 10 | 0.47" | 0.40" | 1.26" | 1.03" | 0.050" | 0.175" | 0.340" | - | 200 |
| MN8-14R/SX | 051128-58635 | 8 AWG | 1/4" | 0.47" | 0.40" | 1.26" | 1.03" | 0.050" | 0.175" | 0.340" | 10 | 100 |
| MN8-14R/SK | 054007-08268 | 8 AWG | 1/4" | 0.47" | 0.40" | 1.26" | 1.03" | 0.050" | 0.175" | 0.340" | - | 200 |
| MN8-516RK | 054007-08269 | 8 AWG | 5/16" | 0.59" | 0.45" | 1.38" | 1.08" | 0.050" | 0.175" | 0.340" | - | 200 |
| MN8-38RX | 051128-58639 | 8 AWG | 3/8" | 0.59" | 0.45" | 1.38" | 1.08" | 0.050" | 0.175" | 0.340" | 10 | 100 |

3M™ Scotchlok™ Ring Tongues

Nylon Insulated Brazed Seam Ring Tongues (continued)

| Order No. | UPC | Conductor Size | Stud Size | (W) | (C) | (L) | (E) | Thickness | Barrel I.D. | Max. Insul. Dia. | Terminals per Carton | Terminals per Case |
|------------|--------------|----------------|-----------|-------|-------|-------|-------|-----------|-------------|------------------|----------------------|--------------------|
| MN8-38RK | 054007-08270 | 8 AWG | 3/8" | 0.59" | 0.45" | 1.38" | 1.08" | 0.050" | 0.175" | 0.340" | - | 200 |
| MN8-12R/SK | 054007-08271 | 8 AWG | 1/2" | 0.81" | 0.69" | 1.72" | 1.32" | 0.050" | 0.175" | 0.340" | - | 200 |
| MN24-2RK | 054007-95136 | 26-24 AWG | 2 | 0.14" | 0.12" | 0.47" | 0.40" | 0.020" | 0.030" | 0.093" | 1000 | 5000 |
| MN24-4RK | 054007-95142 | 26-24 AWG | 4 | 0.20" | 0.21" | 0.60" | 0.49" | 0.020" | 0.030" | 0.093" | - | 1000 |
| MN24-6RK | 054007-95146 | 26-24 AWG | 6 | 0.20" | 0.21" | 0.60" | 0.49" | 0.020" | 0.030" | 0.093" | - | 1000 |
| MN24-8RK | 054007-95161 | 26-24 AWG | 8 | 0.25" | 0.28" | 0.69" | 0.56" | 0.020" | 0.030" | 0.093" | - | 1000 |

Vinyl Insulated Brazed Seam Ring Tongues

Terminal Type Ring
Terminal Style Standard
Insulation Material Vinyl
Barrel Style Brazed
RoHS 2011/65/EU Yes
Agency Approval 
Manufacturing Origin 

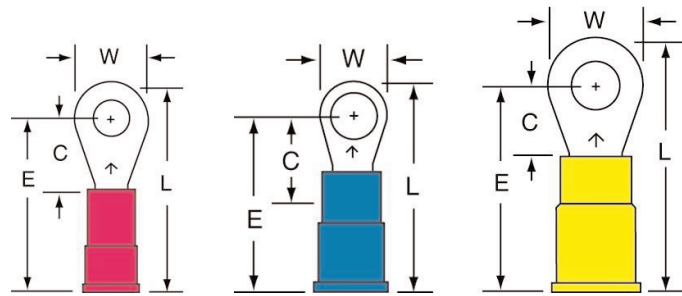

| Order No. | UPC | Conductor Size | Stud Size | (W) | (C) | (L) | (E) | Thickness | Barrel I.D. | Max. Insul. Dia. | Terminals per Carton | Terminals per Case |
|--------------|--------------|----------------|-----------|-------|-------|-------|-------|-----------|-------------|------------------|----------------------|--------------------|
| MV18-4R/SX | 051128-58729 | 22 - 18 AWG | 4 | 0.25" | 0.22" | 0.80" | 0.67" | 0.030" | 0.070" | 0.145" | 100 | 500 |
| MV18-4R/SK | 054007-01046 | 22 - 18 AWG | 4 | 0.25" | 0.22" | 0.80" | 0.67" | 0.030" | 0.070" | 0.145" | - | 1000 |
| MV18-6R/SX | 051128-58730 | 22 - 18 AWG | 6 | 0.25" | 0.22" | 0.80" | 0.67" | 0.030" | 0.070" | 0.145" | 100 | 500 |
| MV18-6R/SK | 054007-01048 | 22 - 18 AWG | 6 | 0.25" | 0.22" | 0.80" | 0.67" | 0.030" | 0.070" | 0.145" | - | 1000 |
| MV18-8R/LX | 051128-58731 | 22 - 18 AWG | 8 | 0.31" | 0.33" | 0.93" | 0.78" | 0.030" | 0.070" | 0.145" | 100 | 500 |
| MV18-8R/LK | 054007-01053 | 22 - 18 AWG | 8 | 0.31" | 0.33" | 0.93" | 0.78" | 0.030" | 0.070" | 0.145" | - | 1000 |
| MV18-10R/LX | 051128-58732 | 22 - 18 AWG | 10 | 0.31" | 0.33" | 0.93" | 0.78" | 0.030" | 0.070" | 0.145" | 100 | 500 |
| MV18-10R/LK | 054007-01055 | 22 - 18 AWG | 10 | 0.31" | 0.33" | 0.93" | 0.78" | 0.030" | 0.070" | 0.145" | - | 1000 |
| MV18-14R/SX | 051128-58733 | 22 - 18 AWG | 1/4" | 0.47" | 0.40" | 1.08" | 0.85" | 0.030" | 0.070" | 0.145" | 100 | 500 |
| MV18-14R/SK | 054007-01056 | 22 - 18 AWG | 1/4" | 0.47" | 0.40" | 1.08" | 0.85" | 0.030" | 0.070" | 0.145" | - | 1000 |
| MV18-516R/SX | 051128-58942 | 22 - 18 AWG | 5/16" | 0.47" | 0.40" | 1.08" | 0.85" | 0.030" | 0.070" | 0.145" | 100 | 500 |
| MV18-38RX | 051128-58734 | 22 - 18 AWG | 3/8" | 0.56" | 0.40" | 1.13" | 0.85" | 0.030" | 0.070" | 0.145" | 100 | 500 |
| MV14-4R/SX | 051128-58752 | 16 - 14 AWG | 4 | 0.25" | 0.22" | 0.80" | 0.67" | 0.030" | 0.090" | 0.170" | 100 | 500 |
| MV14-4R/SK | 054007-01412 | 16 - 14 AWG | 4 | 0.25" | 0.22" | 0.80" | 0.67" | 0.030" | 0.090" | 0.170" | - | 1000 |
| MV14-6R/SX | 051128-58753 | 16 - 14 AWG | 6 | 0.25" | 0.22" | 0.80" | 0.67" | 0.030" | 0.090" | 0.170" | 100 | 500 |
| MV14-6R/SK | 054007-01414 | 16 - 14 AWG | 6 | 0.25" | 0.22" | 0.80" | 0.67" | 0.030" | 0.090" | 0.170" | - | 1000 |
| MV14-8R/SK | 054007-01417 | 16 - 14 AWG | 8 | 0.25" | 0.22" | 0.80" | 0.67" | 0.030" | 0.090" | 0.170" | - | 1000 |
| MV14-8R/LX | 051128-58755 | 16 - 14 AWG | 8 | 0.31" | 0.33" | 0.93" | 0.78" | 0.030" | 0.090" | 0.170" | 100 | 500 |
| MV14-8R/LK | 054007-01419 | 16 - 14 AWG | 8 | 0.31" | 0.33" | 0.93" | 0.78" | 0.030" | 0.090" | 0.170" | - | 1000 |
| MV14-10RK | 054007-01420 | 16 - 14 AWG | 10 | 0.33" | 0.29" | 0.90" | 0.74" | 0.030" | 0.090" | 0.170" | - | 1000 |
| MV14-10R/LX | 051128-58749 | 16 - 14 AWG | 10 | 0.31" | 0.33" | 0.93" | 0.78" | 0.030" | 0.090" | 0.170" | 100 | 500 |
| MV14-10R/LK | 054007-01421 | 16 - 14 AWG | 10 | 0.31" | 0.33" | 0.93" | 0.78" | 0.030" | 0.090" | 0.170" | - | 1000 |
| MV14-14R/SX | 051128-58750 | 16 - 14 AWG | 1/4" | 0.47" | 0.40" | 1.08" | 0.85" | 0.030" | 0.090" | 0.170" | 100 | 500 |
| MV14-14R/SK | 054007-01422 | 16 - 14 AWG | 1/4" | 0.47" | 0.40" | 1.08" | 0.85" | 0.030" | 0.090" | 0.170" | - | 1000 |
| MV14-516R/SX | 051128-58961 | 16 - 14 AWG | 5/16" | 0.47" | 0.40" | 1.08" | 0.85" | 0.030" | 0.090" | 0.170" | 100 | 500 |

Vinyl Insulated Brazed Seam Ring Tongues (continued)

| Order No. | UPC | Conductor Size | Stud Size | (W) | (C) | (L) | (E) | Thickness | Barrel I.D. | Max. Insul. Dia. | Terminals per Carton | Terminals per Case |
|--------------|--------------|----------------|-----------|-------|-------|-------|-------|-----------|-------------|------------------|----------------------|--------------------|
| MV14-516R/SK | 054007-01424 | 16 - 14 AWG | 5/16" | 0.47" | 0.40" | 1.08" | 0.85" | 0.030" | 0.090" | 0.170" | - | 1000 |
| MV14-38RX | 051128-58751 | 16 - 14 AWG | 3/8" | 0.56" | 0.40" | 1.13" | 0.85" | 0.030" | 0.090" | 0.170" | 100 | 500 |
| MV14-38RK | 054007-00546 | 16 - 14 AWG | 3/8" | 0.56" | 0.40" | 1.13" | 0.85" | 0.030" | 0.090" | 0.170" | - | 1000 |
| MV10-4R/SK | 054007-01918 | 12 - 10 AWG | 4 | 0.28" | 0.29" | 0.98" | 0.84" | 0.040" | 0.135" | 0.250" | - | 500 |
| MV10-6RX | 051128-58756 | 12 - 10 AWG | 6 | 0.38" | 0.29" | 1.03" | 0.84" | 0.040" | 0.135" | 0.250" | 50 | 500 |
| MV10-6RK | 054007-01920 | 12 - 10 AWG | 6 | 0.38" | 0.29" | 1.03" | 0.84" | 0.040" | 0.135" | 0.250" | - | 500 |
| MV10-8RX | 051128-58757 | 12 - 10 AWG | 8 | 0.38" | 0.29" | 1.03" | 0.84" | 0.040" | 0.135" | 0.250" | 50 | 500 |
| MV10-8RK | 054007-01922 | 12 - 10 AWG | 8 | 0.38" | 0.29" | 1.03" | 0.84" | 0.040" | 0.135" | 0.250" | - | 500 |
| MV10-10RX | 051128-58758 | 12 - 10 AWG | 10 | 0.38" | 0.29" | 1.03" | 0.84" | 0.040" | 0.135" | 0.250" | 50 | 500 |
| MV10-10RK | 054007-01923 | 12 - 10 AWG | 10 | 0.38" | 0.29" | 1.03" | 0.84" | 0.040" | 0.135" | 0.250" | - | 500 |
| MV10-14R/SX | 051128-58759 | 12 - 10 AWG | 1/4" | 0.53" | 0.44" | 1.26" | 0.99" | 0.040" | 0.135" | 0.250" | 50 | 500 |
| MV10-14R/SK | 054007-01924 | 12 - 10 AWG | 1/4" | 0.53" | 0.44" | 1.26" | 0.99" | 0.040" | 0.135" | 0.250" | - | 500 |
| MV10-516R/SX | 051128-58760 | 12 - 10 AWG | 5/16" | 0.53" | 0.44" | 1.26" | 0.99" | 0.040" | 0.135" | 0.250" | 50 | 500 |
| MV10-516R/SK | 054007-01926 | 12 - 10 AWG | 5/16" | 0.53" | 0.44" | 1.26" | 0.99" | 0.040" | 0.135" | 0.250" | - | 500 |
| MV10-38R/SX | 051128-58983 | 12 - 10 AWG | 3/8" | 0.54" | 0.44" | 1.26" | 0.99" | 0.040" | 0.135" | 0.250" | 50 | 500 |
| MV10-38R/SK | 054007-01928 | 12 - 10 AWG | 3/8" | 0.54" | 0.44" | 1.26" | 0.99" | 0.040" | 0.135" | 0.250" | - | 500 |
| MV10-12RX | 054007-23409 | 12 - 10 AWG | 1/2" | 0.75" | 0.57" | 1.50" | 1.12" | 0.040" | 0.135" | 0.250" | 50 | 500 |
| MV10-12RK | 054007-01931 | 12 - 10 AWG | 1/2" | 0.75" | 0.57" | 1.50" | 1.12" | 0.040" | 0.135" | 0.250" | - | 500 |

Vinyl Insulated Butted Seam Ring Tongues

- Terminal Type Ring
- Terminal Style Standard
- Insulation Material Vinyl
- Barrel Style Butted
- RoHS 2011/65/EU Yes
- Agency Approval 
- Manufacturing Origin 



| Order No. | UPC | Conductor Size | Stud Size | (W) | (C) | (L) | (E) | Thickness | Barrel I.D. | Max. Insul. Dia. | Terminals per Carton | Terminals per Case |
|---------------|--------------|----------------|-----------|-------|-------|-------|-------|-----------|-------------|------------------|----------------------|--------------------|
| MVU18-4R/SK | 054007-01078 | 22 - 18 AWG | 4 | 0.25" | 0.22" | 0.80" | 0.67" | 0.030" | 0.070" | 0.145" | - | 1000 |
| MVU18-6R/SK | 054007-01080 | 22 - 18 AWG | 6 | 0.25" | 0.22" | 0.80" | 0.67" | 0.030" | 0.070" | 0.145" | - | 1000 |
| MVU18-6R/SX | 051128-58814 | 22 - 18 AWG | 6 | 0.25" | 0.22" | 0.80" | 0.67" | 0.030" | 0.070" | 0.145" | 100 | 500 |
| MVU18-8R/LK | 054007-01085 | 22 - 18 AWG | 8 | 0.31" | 0.33" | 0.93" | 0.78" | 0.030" | 0.070" | 0.145" | - | 1000 |
| MVU18-8R/LX | 051128-59040 | 22 - 18 AWG | 8 | 0.31" | 0.33" | 0.93" | 0.78" | 0.030" | 0.070" | 0.145" | 100 | 500 |
| MVU18-8R/SX | 051128-58852 | 22 - 18 AWG | 8 | 0.25" | 0.22" | 0.80" | 0.67" | 0.030" | 0.070" | 0.145" | 100 | 500 |
| MVU18-10R/LK | 054007-01087 | 22 - 18 AWG | 10 | 0.31" | 0.33" | 0.93" | 0.78" | 0.030" | 0.070" | 0.145" | - | 1000 |
| MVU18-10R/LX | 054007-35107 | 22 - 18 AWG | 10 | 0.31" | 0.33" | 0.93" | 0.78" | 0.030" | 0.070" | 0.145" | 50 | 500 |
| MVU18-10RX | 051128-58853 | 22 - 18 AWG | 10 | 0.31" | 0.29" | 0.90" | 0.74" | 0.030" | 0.070" | 0.145" | 100 | 500 |
| MVU18-14R/SK | 054007-01088 | 22 - 18 AWG | 1/4" | 0.47" | 0.40" | 1.08" | 0.85" | 0.030" | 0.070" | 0.145" | - | 1000 |
| MVU18-14R/SX | 051128-58815 | 22 - 18 AWG | 1/4" | 0.47" | 0.40" | 1.08" | 0.85" | 0.030" | 0.070" | 0.145" | 100 | 500 |
| MVU18-516R/SK | 054007-01090 | 22 - 18 AWG | 5/16" | 0.47" | 0.40" | 1.08" | 0.85" | 0.030" | 0.070" | 0.145" | - | 1000 |
| MVU18-38RK | 054007-01092 | 22 - 18 AWG | 3/8" | 0.56" | 0.40" | 1.13" | 0.85" | 0.030" | 0.070" | 0.145" | - | 1000 |

3M™ Scotchlok™ Ring Tongues

Vinyl Insulated Butted Seam Ring Tongues (continued)

| Order No. | UPC | Conductor Size | Stud Size | (W) | (C) | (L) | (E) | Thickness | Barrel I.D. | Max. Insul. Dia. | Terminals per Carton | Terminals per Case |
|---------------|--------------|----------------|-----------|-------|-------|-------|-------|-----------|-------------|------------------|----------------------|--------------------|
| MVU14-4R/SK | 054007-01444 | 16 - 14 AWG | 4 | 0.25" | 0.22" | 0.80" | 0.67" | 0.030" | 0.070" | 0.145" | - | 1000 |
| MVU14-6R/SK | 054007-01446 | 16 - 14 AWG | 6 | 0.25" | 0.22" | 0.80" | 0.67" | 0.030" | 0.070" | 0.145" | - | 1000 |
| MVU14-6R/SX | 051128-58818 | 16 - 14 AWG | 6 | 0.25" | 0.22" | 0.80" | 0.67" | 0.030" | 0.070" | 0.145" | 100 | 500 |
| MVU14-8RK | 054007-01450 | 16 - 14 AWG | 8 | 0.33" | 0.29" | 0.90" | 0.74" | 0.030" | 0.070" | 0.145" | - | 1000 |
| MVU14-8RX | 051128-58880 | 16 - 14 AWG | 8 | 0.33" | 0.29" | 0.90" | 0.74" | 0.030" | 0.070" | 0.145" | 100 | 500 |
| MVU14-8R/LK | 054007-01451 | 16 - 14 AWG | 8 | 0.31" | 0.33" | 0.93" | 0.78" | 0.030" | 0.070" | 0.145" | - | 1000 |
| MVU14-8R/SK | 054007-01449 | 16 - 14 AWG | 8 | 0.25" | 0.22" | 0.80" | 0.67" | 0.030" | 0.070" | 0.145" | - | 1000 |
| MVU14-8R/SX | 051128-58887 | 16 - 14 AWG | 8 | 0.25" | 0.22" | 0.80" | 0.67" | 0.030" | 0.070" | 0.145" | 100 | 500 |
| MVU14-10R/LK | 054007-01453 | 16 - 14 AWG | 10 | 0.31" | 0.33" | 0.93" | 0.78" | 0.030" | 0.070" | 0.145" | - | 1000 |
| MVU14-10RK | 054007-01452 | 16 - 14 AWG | 10 | 0.33" | 0.29" | 0.90" | 0.74" | 0.030" | 0.070" | 0.145" | - | 1000 |
| MVU14-10RX | 051128-58819 | 16 - 14 AWG | 10 | 0.33" | 0.29" | 0.90" | 0.74" | 0.030" | 0.070" | 0.145" | 100 | 500 |
| MVU14-14R/SK | 054007-01454 | 16 - 14 AWG | 1/4" | 0.47" | 0.40" | 1.08" | 0.85" | 0.030" | 0.070" | 0.145" | - | 1000 |
| MVU14-14R/SX | 051128-58820 | 16 - 14 AWG | 1/4" | 0.47" | 0.40" | 1.08" | 0.85" | 0.030" | 0.070" | 0.145" | 100 | 500 |
| MVU14-38RK | 054007-01458 | 16 - 14 AWG | 3/8" | 0.56" | 0.40" | 1.13" | 0.85" | 0.030" | 0.070" | 0.145" | - | 1000 |
| MVU14-38R/SX | 051128-58821 | 16 - 14 AWG | 3/8" | - | - | - | - | 0.030" | 0.070" | 0.145" | 100 | 500 |
| MVU14-516R/SK | 054007-01456 | 16 - 14 AWG | 5/16" | 0.47" | 0.40" | 1.08" | 0.85" | 0.030" | 0.070" | 0.145" | - | 1000 |
| MVU10-4R/SK | 054007-01946 | 12 - 10 AWG | 4 | 0.28" | 0.29" | 0.98" | 0.84" | 0.040" | 0.135" | 0.250" | - | 500 |
| MVU10-6RK | 054007-01948 | 12 - 10 AWG | 6 | 0.38" | 0.29" | 1.03" | 0.84" | 0.040" | 0.135" | 0.250" | - | 500 |
| MVU10-6RX | 051128-58854 | 12 - 10 AWG | 6 | 0.38" | 0.29" | 1.03" | 0.84" | 0.040" | 0.135" | 0.250" | 50 | 500 |
| MVU10-8RK | 054007-01950 | 12 - 10 AWG | 8 | 0.38" | 0.29" | 1.03" | 0.84" | 0.040" | 0.135" | 0.250" | - | 500 |
| MVU10-8RX | 051128-58879 | 12 - 10 AWG | 8 | 0.38" | 0.29" | 1.03" | 0.84" | 0.040" | 0.135" | 0.250" | 50 | 500 |
| MVU10-8R/SX | 051128-58881 | 12 - 10 AWG | 8 | 0.28" | 0.29" | 0.98" | 0.84" | 0.040" | 0.135" | 0.250" | 50 | 500 |
| MVU10-10RK | 054007-01951 | 12 - 10 AWG | 10 | 0.38" | 0.29" | 1.03" | 0.84" | 0.040" | 0.135" | 0.250" | - | 500 |
| MVU10-10RX | 051128-58824 | 12 - 10 AWG | 10 | 0.38" | 0.29" | 1.03" | 0.84" | 0.040" | 0.135" | 0.250" | 50 | 500 |
| MVU10-14R/SK | 054007-01952 | 12 - 10 AWG | 1/4" | 0.53" | 0.44" | 1.26" | 0.99" | 0.040" | 0.135" | 0.250" | - | 500 |
| MVU10-14R/SX | 051128-58825 | 12 - 10 AWG | 1/4" | 0.53" | 0.44" | 1.26" | 0.99" | 0.040" | 0.135" | 0.250" | 50 | 500 |
| MVU10-38R/SK | 054007-01956 | 12 - 10 AWG | 3/8" | 0.54" | 0.44" | 1.26" | 0.99" | 0.040" | 0.135" | 0.250" | - | 500 |
| MVU10-38R/SX | 051128-58882 | 12 - 10 AWG | 3/8" | 0.54" | 0.44" | 1.26" | 0.99" | 0.040" | 0.135" | 0.250" | 50 | 500 |
| MVU10-38RX | 051128-58826 | 12 - 10 AWG | 3/8" | 0.59" | 0.44" | 1.29" | 0.99" | 0.040" | 0.135" | 0.250" | 50 | 500 |
| MVU10-516R/SK | 054007-01954 | 12 - 10 AWG | 5/16" | 0.53" | 0.44" | 1.26" | 0.99" | 0.040" | 0.135" | 0.250" | - | 500 |

3M™ Scotchlok™ Ring Tongues

Non-Insulated Brazed Seam Ring Tongues

Terminal Type Ring
 Terminal Style Standard
 Insulation Material Non-Insulated
 Barrel Style Brazed
 RoHS 2011/65/EU Yes

Agency Approval



Manufacturing Origin



| Order No. | UPC | Conductor Size | Stud Size | (W) | (C) | (L) | (E) | Thickness | Barrel I.D. | Terminals per Carton | Terminals per Case |
|-------------|--------------|----------------|-----------|-------|-------|-------|-------|-----------|-------------|----------------------|--------------------|
| M18-4R/SX | 051128-58939 | 22 - 18 AWG | 4 | 0.25" | 0.22" | 0.60" | 0.47" | 0.030" | 0.070" | 100 | 500 |
| M18-6R/SK | 054007-01016 | 22 - 18 AWG | 6 | 0.25" | 0.22" | 0.60" | 0.47" | 0.030" | 0.070" | - | 1000 |
| M18-6R/SX | 051128-58640 | 22 - 18 AWG | 6 | 0.25" | 0.22" | 0.60" | 0.47" | 0.030" | 0.070" | 100 | 500 |
| M18-8R/LX | 051128-58656 | 22 - 18 AWG | 8 | 0.31" | 0.33" | 0.74" | 0.58" | 0.030" | 0.070" | 100 | 500 |
| M18-8R/LK | 054007-01021 | 22 - 18 AWG | 8 | 0.31" | 0.33" | 0.74" | 0.58" | 0.030" | 0.070" | - | 1000 |
| M18-10R/LX | 051128-58641 | 22 - 18 AWG | 10 | 0.31" | 0.33" | 0.74" | 0.58" | 0.030" | 0.070" | 100 | 500 |
| M18-10R/LK | 054007-01023 | 22 - 18 AWG | 10 | 0.31" | 0.33" | 0.74" | 0.58" | 0.030" | 0.070" | - | 1000 |
| M18-14R/SX | 051128-58940 | 22 - 18 AWG | 1/4" | 0.47" | 0.40" | 0.89" | 0.65" | 0.030" | 0.070" | 100 | 500 |
| M18-38RX | 051128-58941 | 22 - 18 AWG | 3/8" | 0.56" | 0.40" | 0.93" | 0.65" | 0.030" | 0.070" | 100 | 500 |
| M14-4R/SX | 051128-58959 | 16 - 14 AWG | 4 | 0.25" | 0.22" | 0.60" | 0.47" | 0.030" | 0.090" | 100 | 500 |
| M14-6R/SK | 054007-01382 | 16 - 14 AWG | 6 | 0.25" | 0.22" | 0.60" | 0.47" | 0.030" | 0.090" | - | 1000 |
| M14-6R/SX | 051128-58658 | 16 - 14 AWG | 6 | 0.25" | 0.22" | 0.60" | 0.47" | 0.030" | 0.090" | 100 | 500 |
| M14-6R/LK | 054007-01384 | 16 - 14 AWG | 6 | 0.31" | 0.33" | 0.74" | 0.58" | 0.030" | 0.090" | - | 1000 |
| M14-8R/LK | 054007-13880 | 16 - 14 AWG | 8 | 0.31" | 0.33" | 0.74" | 0.58" | 0.030" | 0.090" | - | 1000 |
| M14-8R/LX | 051128-58710 | 16 - 14 AWG | 8 | 0.31" | 0.33" | 0.74" | 0.58" | 0.030" | 0.090" | 100 | 500 |
| M14-10RK | 054007-13929 | 16 - 14 AWG | 10 | 0.33" | 0.29" | 0.70" | 0.54" | 0.030" | 0.090" | - | 1000 |
| M14-10R/LK | 054007-01389 | 16 - 14 AWG | 10 | 0.31" | 0.33" | 0.74" | 0.58" | 0.030" | 0.090" | - | 1000 |
| M14-10R/LX | 051128-58659 | 16 - 14 AWG | 10 | 0.31" | 0.33" | 0.74" | 0.58" | 0.030" | 0.090" | 100 | 500 |
| M14-14R/SK | 054007-01390 | 16 - 14 AWG | 1/4" | 0.47" | 0.40" | 0.89" | 0.65" | 0.030" | 0.090" | - | 1000 |
| M14-14R/SX | 051128-58660 | 16 - 14 AWG | 1/4" | 0.47" | 0.40" | 0.89" | 0.65" | 0.030" | 0.090" | 100 | 500 |
| M14-38RX | 051128-58960 | 16 - 14 AWG | 3/8" | 0.56" | 0.40" | 0.93" | 0.65" | 0.030" | 0.090" | 100 | 500 |
| M14-516R/SK | 054007-01392 | 16 - 14 AWG | 5/16" | 0.47" | 0.40" | 0.89" | 0.65" | 0.030" | 0.090" | - | 1000 |
| M10-4R/SK | 054007-01890 | 12 - 10 AWG | 4 | 0.28" | 0.29" | 0.68" | 0.54" | 0.040" | 0.135" | - | 500 |
| M10-6RX | 051128-58681 | 12 - 10 AWG | 6 | 0.38" | 0.29" | 0.73" | 0.54" | 0.040" | 0.135" | 50 | 500 |
| M10-6RK | 054007-01892 | 12 - 10 AWG | 6 | 0.38" | 0.29" | 0.73" | 0.54" | 0.040" | 0.135" | - | 500 |
| M10-8RX | 051128-58714 | 12 - 10 AWG | 8 | 0.38" | 0.29" | 0.73" | 0.54" | 0.040" | 0.135" | 50 | 500 |
| M10-8RK | 054007-01894 | 12 - 10 AWG | 8 | 0.38" | 0.29" | 0.73" | 0.54" | 0.040" | 0.135" | - | 500 |
| M10-10RX | 051128-58682 | 12 - 10 AWG | 10 | 0.38" | 0.29" | 0.73" | 0.54" | 0.040" | 0.135" | 50 | 500 |
| M10-10RK | 054007-14002 | 12 - 10 AWG | 10 | 0.38" | 0.29" | 0.73" | 0.54" | 0.040" | 0.135" | - | 500 |
| M10-14R/SX | 051128-58683 | 12 - 10 AWG | 1/4" | 0.54" | 0.44" | 0.96" | 0.69" | 0.040" | 0.135" | 50 | 500 |
| M10-14R/SK | 054007-01896 | 12 - 10 AWG | 1/4" | 0.54" | 0.44" | 0.96" | 0.69" | 0.040" | 0.135" | - | 500 |
| M10-516R/SX | 051128-58981 | 12 - 10 AWG | 5/16" | 0.54" | 0.44" | 0.96" | 0.69" | 0.040" | 0.135" | 100 | 500 |
| M10-38R/SX | 051128-58982 | 12 - 10 AWG | 3/8" | 0.54" | 0.44" | 0.96" | 0.69" | 0.040" | 0.135" | 50 | 500 |
| M10-38R/SK | 054007-01900 | 12 - 10 AWG | 3/8" | 0.54" | 0.44" | 0.96" | 0.69" | 0.040" | 0.135" | - | 500 |
| M10-12RK | 054007-01903 | 12 - 10 AWG | 1/2" | 0.75" | 0.57" | 1.19" | 0.82" | 0.040" | 0.135" | - | 500 |
| M8-10R/SX | 051128-58693 | 8 AWG | 10 | 0.47" | 0.40" | 0.95" | 0.72" | 0.050" | 0.175" | 10 | 100 |

Non-Insulated Brazed Seam Ring Tongues (continued)

| Order No. | UPC | Conductor Size | Stud Size | (W) | (C) | (L) | (E) | Thickness | Barrel I.D. | Terminals per Carton | Terminals per Case |
|-----------|--------------|----------------|-----------|-------|-------|-------|-------|-----------|-------------|----------------------|--------------------|
| M8-10R/SK | 054007-02118 | 8 AWG | 10 | 0.47" | 0.40" | 0.95" | 0.72" | 0.050" | 0.175" | - | 200 |
| M8-14R/SX | 051128-58694 | 8 AWG | 1/4" | 0.47" | 0.40" | 0.95" | 0.72" | 0.050" | 0.175" | 10 | 100 |
| M8-14R/SK | 054007-02120 | 8 AWG | 1/4" | 0.47" | 0.40" | 0.95" | 0.72" | 0.050" | 0.175" | - | 200 |
| M8-516RX | 051128-58695 | 8 AWG | 5/16" | 0.59" | 0.45" | 1.06" | 0.77" | 0.050" | 0.175" | 10 | 100 |
| M8-516RK | 054007-02122 | 8 AWG | 5/16" | 0.59" | 0.45" | 1.06" | 0.77" | 0.050" | 0.175" | - | 200 |
| M8-38RX | 051128-58696 | 8 AWG | 3/8" | 0.59" | 0.45" | 1.06" | 0.77" | 0.050" | 0.175" | 10 | 100 |
| M8-38RK | 054007-02123 | 8 AWG | 3/8" | 0.59" | 0.45" | 1.06" | 0.77" | 0.050" | 0.175" | - | 200 |
| M8-12R/SK | 054007-02126 | 8 AWG | 1/2" | 0.81" | 0.69" | 1.41" | 1.00" | 0.050" | 0.175" | - | 200 |
| M6-10R/SX | 051128-58697 | 6 AWG | 10 | 0.47" | 0.52" | 1.14" | 0.91" | 0.050" | 0.250" | 10 | 100 |
| M6-10R/SK | 054007-02147 | 6 AWG | 10 | 0.47" | 0.52" | 1.14" | 0.91" | 0.050" | 0.250" | - | 200 |
| M6-14R/SX | 051128-58698 | 6 AWG | 1/4" | 0.47" | 0.52" | 1.14" | 0.91" | 0.050" | 0.250" | 10 | 100 |
| M6-14R/SK | 054007-02149 | 6 AWG | 1/4" | 0.47" | 0.52" | 1.14" | 0.91" | 0.050" | 0.250" | - | 200 |
| M6-516RX | 051128-58699 | 6 AWG | 5/16" | 0.63" | 0.52" | 1.22" | 0.91" | 0.050" | 0.250" | 10 | 100 |
| M6-516RK | 054007-02151 | 6 AWG | 5/16" | 0.63" | 0.52" | 1.22" | 0.91" | 0.050" | 0.250" | - | 200 |
| M6-38RX | 051128-58700 | 6 AWG | 3/8" | 0.63" | 0.52" | 1.22" | 0.91" | 0.050" | 0.250" | 10 | 100 |
| M6-38RK | 054007-02152 | 6 AWG | 3/8" | 0.63" | 0.52" | 1.22" | 0.91" | 0.050" | 0.250" | - | 200 |
| M6-12R/SK | 054007-02155 | 6 AWG | 1/2" | 0.81" | 0.63" | 1.42" | 1.02" | 0.050" | 0.250" | - | 200 |
| M4-10RX | 051128-58992 | 4 AWG | 10 | 0.68" | 0.53" | 1.34" | 1.00" | 0.075" | 0.280" | 10 | 100 |
| M4-14RX | 051128-58701 | 4 AWG | 1/4" | 0.68" | 0.53" | 1.34" | 1.00" | 0.075" | 0.280" | 10 | 100 |
| M4-14RK | 054007-02177 | 4 AWG | 1/4" | 0.68" | 0.53" | 1.34" | 1.00" | 0.075" | 0.280" | - | 200 |
| M4-516RX | 051128-58702 | 4 AWG | 5/16" | 0.68" | 0.53" | 1.34" | 1.00" | 0.075" | 0.280" | 10 | 100 |
| M4-516RK | 054007-02178 | 4 AWG | 5/16" | 0.68" | 0.53" | 1.34" | 1.00" | 0.075" | 0.280" | - | 200 |
| M4-38RX | 051128-58703 | 4 AWG | 3/8" | 0.68" | 0.53" | 1.34" | 1.00" | 0.075" | 0.280" | 10 | 100 |
| M4-38RK | 054007-02179 | 4 AWG | 3/8" | 0.68" | 0.53" | 1.34" | 1.00" | 0.075" | 0.280" | - | 200 |
| M4-12R/SK | 054007-02182 | 4 AWG | 1/2" | 0.68" | 0.53" | 1.34" | 1.00" | 0.075" | 0.280" | - | 200 |

3M™ Scotchlok™ Ring Tongues

Non-Insulated Butted Seam Ring Tongues

Terminal Type Ring
 Terminal Style Standard
 Insulation Material Non-Insulated
 Barrel Style Butted
 RoHS 2011/65/EU Yes



Agency Approval  

Manufacturing Origin 



| Order No. | UPC | Conductor Size | Stud Size | (W) | (C) | (L) | (E) | Thickness | Barrel I.D. | Terminals per Carton | Terminals per Case |
|-------------|--------------|----------------|-----------|-------|-------|-------|-------|-----------|-------------|----------------------|--------------------|
| MU18-4R/SK | 054007-00998 | 22 - 18 AWG | 4 | 0.25" | 0.22" | 0.60" | 0.47" | 0.030" | 0.070" | - | 1000 |
| MU18-6R/SK | 054007-01000 | 22 - 18 AWG | 6 | 0.25" | 0.22" | 0.60" | 0.47" | 0.030" | 0.070" | - | 1000 |
| MU18-8R/LK | 054007-01005 | 22 - 18 AWG | 8 | 0.31" | 0.33" | 0.74" | 0.58" | 0.030" | 0.070" | - | 1000 |
| MU18-8RLX | 051128-59037 | 22 - 18 AWG | 8 | 0.31" | 0.33" | 0.74" | 0.58" | 0.030" | 0.070" | 100 | 500 |
| MU18-10R/LK | 054007-01007 | 22 - 18 AWG | 10 | 0.31" | 0.33" | 0.74" | 0.58" | 0.030" | 0.070" | - | 1000 |
| MU18-10RX | 051128-59004 | 22 - 18 AWG | 10 | 0.33" | 0.29" | 0.70" | 0.54" | 0.030" | 0.070" | 100 | 500 |
| MU18-14R/SK | 054007-01008 | 22 - 18 AWG | 1/4" | 0.47" | 0.40" | 0.89" | 0.65" | 0.030" | 0.070" | - | 1000 |
| MU18-38RK | 054007-01012 | 22 - 18 AWG | 3/8" | 0.56" | 0.40" | 0.93" | 0.65" | 0.030" | 0.070" | - | 1000 |
| MU14-4R/SK | 054007-01364 | 16 - 14 AWG | 4 | 0.25" | 0.22" | 0.60" | 0.47" | 0.030" | 0.090" | - | 1000 |
| MU14-6R/SK | 054007-01366 | 16 - 14 AWG | 6 | 0.25" | 0.22" | 0.60" | 0.47" | 0.030" | 0.090" | - | 1000 |
| MU14-8R/LK | 054007-01371 | 16 - 14 AWG | 8 | 0.25" | 0.22" | 0.74" | 0.58" | 0.030" | 0.090" | - | 1000 |
| MU14-8RLX | 051128-59038 | 16 - 14 AWG | 8 | 0.25" | 0.22" | 0.74" | 0.58" | 0.030" | 0.090" | 100 | 500 |
| MU14-10R/LK | 054007-01373 | 16 - 14 AWG | 10 | 0.31" | 0.33" | 0.74" | 0.58" | 0.030" | 0.090" | - | 1000 |
| MU14-10RK | 054007-01372 | 16 - 14 AWG | 10 | 0.33" | 0.29" | 0.70" | 0.54" | 0.030" | 0.090" | - | 1000 |
| MU14-10RX | 051128-59005 | 16 - 14 AWG | 10 | 0.33" | 0.29" | 0.70" | 0.54" | 0.030" | 0.090" | 100 | 500 |
| MU14-14R/SK | 054007-01374 | 16 - 14 AWG | 1/4" | 0.47" | 0.40" | 0.89" | 0.65" | 0.030" | 0.090" | - | 1000 |
| MU10-4R/SK | 054007-01876 | 12 - 10 AWG | 4 | 0.28" | 0.29" | 0.68" | 0.54" | 0.040" | 0.135" | - | 500 |
| MU10-6RK | 054007-01878 | 12 - 10 AWG | 6 | 0.38" | 0.29" | 0.73" | 0.54" | 0.040" | 0.135" | - | 500 |
| MU10-6RX | 051128-58857 | 12 - 10 AWG | 6 | 0.38" | 0.29" | 0.73" | 0.54" | 0.040" | 0.135" | 50 | 500 |
| MU10-8RK | 054007-01880 | 12 - 10 AWG | 8 | 0.38" | 0.29" | 0.73" | 0.54" | 0.040" | 0.135" | - | 500 |
| MU10-8RX | 051128-59039 | 12 - 10 AWG | 8 | 0.38" | 0.29" | 0.73" | 0.54" | 0.040" | 0.135" | 100 | 500 |
| MU10-10RK | 054007-01881 | 12 - 10 AWG | 10 | 0.38" | 0.29" | 0.73" | 0.54" | 0.040" | 0.135" | - | 500 |
| MU10-14R/SK | 054007-01882 | 12 - 10 AWG | 1/4" | 0.53" | 0.44" | 0.96" | 0.69" | 0.040" | 0.135" | - | 500 |

Nylon Insulated with Insulation Grip Multi-Stud Ring Tongues

Terminal Type Ring
 Terminal Style Multi-Stud
 Insulation Material Nylon with Insulation Grip
 Barrel Style Butted
 RoHS 2011/65/EU Yes
 Agency Approval 
 Manufacturing Origin  With U.S. and Global Content



| Order No. | UPC | Conductor Size | Stud Size | (W) | (C) | (L) | (E) | Thickness | Barrel I.D. | Max. Insul. Dia. | Terminals per Carton | Terminals per Case |
|-------------|--------------|----------------|-----------|-------|-------|-------|-------|-----------|-------------|------------------|----------------------|--------------------|
| MNG18-610RX | 051128-58958 | 22 - 18 AWG | 6 - 10 | 0.34" | 0.31" | 1.00" | 0.75" | 0.030" | 0.070" | 0.145" | 100 | 500 |
| MNG14-610RX | 051128-58980 | 16 - 14 AWG | 6 - 10 | 0.34" | 0.31" | 1.02" | 0.77" | 0.030" | 0.090" | 0.170" | 100 | 500 |
| MNG10-610RX | 051128-58990 | 12 - 10 AWG | 6 - 10 | 0.39" | 0.35" | 1.19" | 0.80" | 0.040" | 0.135" | 0.250" | 50 | 500 |

Vinyl Insulated Brazed Seam Multi-Stud Ring Tongues

Terminal Type Ring
 Terminal Style Multi-Stud
 Insulation Material Vinyl
 Barrel Style Brazed
 RoHS 2011/65/EU Yes
 Agency Approval 
 Manufacturing Origin 



| Order No. | UPC | Conductor Size | Stud Size | (W) | (C) | (L) | (E) | Thickness | Barrel I.D. | Max. Insul. Dia. | Terminals per Carton | Terminals per Case |
|------------|--------------|----------------|-----------|-------|-------|-------|-------|-----------|-------------|------------------|----------------------|--------------------|
| MV18-610RK | 054007-01342 | 22 - 18 AWG | 6 - 10 | 0.34" | 0.31" | 1.01" | 0.76" | 0.030" | 0.070" | 0.145" | - | 1000 |
| MV18-610RX | 051128-58768 | 22 - 18 AWG | 6 - 10 | 0.34" | 0.31" | 1.01" | 0.76" | 0.030" | 0.070" | 0.145" | 100 | 500 |
| MV14-610RK | 054007-01851 | 16 - 14 AWG | 6 - 10 | 0.34" | 0.31" | 1.01" | 0.76" | 0.030" | 0.090" | 0.170" | - | 1000 |
| MV14-610RX | 051128-58769 | 16 - 14 AWG | 6 - 10 | 0.34" | 0.31" | 1.01" | 0.76" | 0.030" | 0.090" | 0.170" | 100 | 500 |
| MV10-610RK | 054007-02099 | 12 - 10 AWG | 6 - 10 | 0.39" | 0.35" | 1.19" | 0.80" | 0.040" | 0.135" | 0.250" | - | 500 |
| MV10-610RX | 051128-58770 | 12 - 10 AWG | 6 - 10 | 0.39" | 0.35" | 1.19" | 0.80" | 0.040" | 0.135" | 0.250" | 50 | 500 |

Non-Insulated Copper Seamless Compression Lug Ring Tongues

Terminal Type Ring
 Terminal Style Compression Lug
 Insulation Material Non-Insulated
 Barrel Style Seamless
 RoHS 2011/65/EU Yes

Agency Approval



Manufacturing Origin



| Order No. | UPC | Conductor Size | Stud Size | Color Code | (W) | (C) | (L) | Thickness | Barrel I.D. | Terminals per Carton | Terminals per Case |
|------------|--------------|----------------|-----------|------------|-------|-------|-------|-----------|-------------|----------------------|--------------------|
| MC2-14RX | 054007-09187 | 2 AWG | 1/4" | Brown | 0.65" | 0.41" | 1.69" | 0.100" | 0.340" | 10 | 100 |
| MC2-38RX | 054007-09189 | 2 AWG | 3/8" | Brown | 0.65" | 0.41" | 1.69" | 0.100" | 0.340" | 10 | 100 |
| MC2-516RX | 054007-09188 | 2 AWG | 5/16" | Brown | 0.65" | 0.41" | 1.69" | 0.100" | 0.340" | 10 | 100 |
| MC1-14RX | 054007-09190 | 1 AWG | 1/4" | Green | 0.65" | 0.43" | 1.71" | 0.100" | 0.360" | 10 | 100 |
| MC1-516RX | 054007-09191 | 1 AWG | 5/16" | Green | 0.65" | 0.43" | 1.71" | 0.100" | 0.360" | 10 | 100 |
| MC1-38RX | 054007-09192 | 1 AWG | 3/8" | Green | 0.68" | 0.43" | 1.71" | 0.100" | 0.360" | 10 | 100 |
| MC1/0-14RX | 054007-09193 | 1/0 AWG | 1/4" | Pink | 0.75" | 0.38" | 1.84" | 0.100" | 0.410" | 10 | 100 |
| MC1/0-38RX | 054007-09194 | 1/0 AWG | 3/8" | Pink | 0.75" | 0.42" | 1.84" | 0.100" | 0.410" | 10 | 100 |
| MC1/0-12RX | 054007-09195 | 1/0 AWG | 1/2" | Pink | 0.75" | 0.42" | 1.84" | 0.100" | 0.410" | 10 | 100 |
| MC2/0-38RX | 054007-09197 | 2/0 AWG | 3/8" | Black | 0.83" | 0.48" | 2.05" | 0.100" | 0.460" | 10 | 100 |
| MC2/0-12RX | 054007-09198 | 2/0 AWG | 1/2" | Black | 0.83" | 0.48" | 2.05" | 0.100" | 0.460" | 10 | 100 |
| MC3/0-38RX | 054007-09199 | 3/0 AWG | 3/8" | Orange | 0.91" | 0.50" | 2.24" | 0.120" | 0.510" | 6 | 60 |
| MC3/0-12RX | 054007-09200 | 3/0 AWG | 1/2" | Orange | 0.91" | 0.50" | 2.24" | 0.120" | 0.510" | 6 | 60 |
| MC4/0-12RX | 054007-09202 | 4/0 AWG | 1/2" | Purple | 1.00" | 0.52" | 2.29" | 0.125" | 0.560" | 6 | 60 |
| MC4/0-38RX | 054007-09201 | 4/0 AWG | 3/8" | Purple | 1.00" | 0.52" | 2.29" | 0.125" | 0.560" | 6 | 60 |
| MC250-12RX | 054007-09204 | 250 kcmil | 1/2" | Yellow | 1.13" | 0.60" | 2.43" | 0.140" | 0.630" | 6 | 60 |
| MC250-38RX | 054007-09203 | 250 kcmil | 3/8" | Yellow | 1.13" | 0.60" | 2.43" | 0.140" | 0.630" | 6 | 60 |

Nylon Insulated with Insulation Grip Standard Forks

Terminal Type Fork
 Terminal Style Standard
 Insulation Material Nylon with Insulation Grip
 Barrel Style Butted
 RoHS 2011/65/EU Yes

Agency Approval



Manufacturing Origin

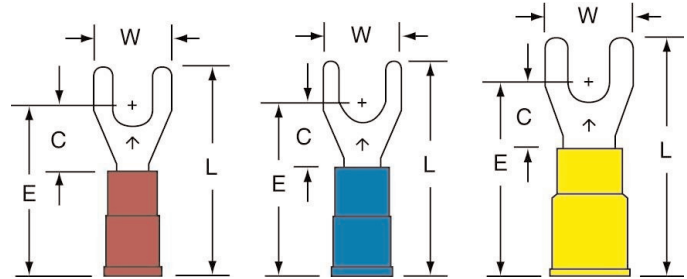

| Order No. | UPC | Conductor Size | Stud Size | (W) | (C) | (L) | (E) | Thickness | Barrel I.D. | Max. Insul. Dia. | Terminals per Carton | Terminals per Case |
|------------|--------------|----------------|-----------|-------|-------|-------|-------|-----------|-------------|------------------|----------------------|--------------------|
| MNG18-6FX | 051128-58650 | 22 - 18 AWG | 6 | 0.34" | 0.29" | 0.89" | 0.73" | 0.030" | 0.070" | 0.145" | 100 | 500 |
| MNG18-8FX | 051128-58651 | 22 - 18 AWG | 8 | 0.34" | 0.29" | 0.89" | 0.73" | 0.030" | 0.070" | 0.145" | 100 | 500 |
| MNG18-10FX | 051128-58858 | 22 - 18 AWG | 10 | 0.34" | 0.29" | 0.89" | 0.73" | 0.030" | 0.070" | 0.145" | 100 | 500 |
| MNG14-6FX | 051128-58665 | 16 - 14 AWG | 6 | 0.34" | 0.29" | 0.91" | 0.75" | 0.030" | 0.070" | 0.145" | 100 | 500 |
| MNG14-8FK | 054007-01536 | 16 - 14 AWG | 8 | 0.34" | 0.29" | 0.91" | 0.75" | 0.030" | 0.070" | 0.145" | - | 1000 |
| MNG14-8FX | 051128-58666 | 16 - 14 AWG | 8 | 0.34" | 0.29" | 0.91" | 0.75" | 0.030" | 0.070" | 0.145" | 100 | 500 |
| MNG14-10FK | 054007-01538 | 16 - 14 AWG | 10 | 0.34" | 0.29" | 0.91" | 0.75" | 0.030" | 0.070" | 0.145" | - | 1000 |
| MNG14-10FX | 051128-58667 | 16 - 14 AWG | 10 | 0.34" | 0.29" | 0.91" | 0.75" | 0.030" | 0.070" | 0.145" | 100 | 500 |
| MNG10-6FX | 051128-58859 | 12 - 10 AWG | 6 | 0.38" | 0.29" | 1.03" | 0.84" | 0.040" | 0.135" | 0.250" | 50 | 500 |
| MNG10-8FK | 054007-01982 | 12 - 10 AWG | 8 | 0.38" | 0.29" | 1.03" | 0.84" | 0.040" | 0.135" | 0.250" | - | 500 |
| MNG10-8FX | 051128-58688 | 12 - 10 AWG | 8 | 0.38" | 0.29" | 1.03" | 0.84" | 0.040" | 0.135" | 0.250" | 50 | 500 |
| MNG10-10FK | 054007-01983 | 12 - 10 AWG | 10 | 0.38" | 0.29" | 1.03" | 0.84" | 0.040" | 0.135" | 0.250" | - | 500 |
| MNG10-10FX | 051128-58717 | 12 - 10 AWG | 10 | 0.38" | 0.29" | 1.03" | 0.84" | 0.040" | 0.135" | 0.250" | 50 | 500 |

Vinyl Insulated Braze Seam Standard Forks

Terminal Type Fork
 Terminal Style Standard
 Insulation Material Vinyl
 Barrel Style Braze
 RoHS 2011/65/EU Yes



| Order No. | UPC | Conductor Size | Stud Size | (W) | (C) | (L) | (E) | Thickness | Barrel I.D. | Max. Insul. Dia. | Terminals per Carton | Terminals per Case |
|-----------|--------------|----------------|-----------|-------|-------|-------|-------|-----------|-------------|------------------|----------------------|--------------------|
| MV18-6FX | 051128-58735 | 22 - 18 AWG | 6 | 0.34" | 0.29" | 0.90" | 0.74" | 0.030" | 0.070" | 0.145" | 100 | 500 |
| MV18-6FK | 054007-01162 | 22 - 18 AWG | 6 | 0.34" | 0.29" | 0.90" | 0.74" | 0.030" | 0.070" | 0.145" | - | 1000 |
| MV18-8FX | 051128-58736 | 22 - 18 AWG | 8 | 0.34" | 0.29" | 0.90" | 0.74" | 0.030" | 0.070" | 0.145" | 100 | 500 |
| MV18-8FK | 054007-01164 | 22 - 18 AWG | 8 | 0.34" | 0.29" | 0.90" | 0.74" | 0.030" | 0.070" | 0.145" | - | 1000 |
| MV18-10FX | 051128-58737 | 22 - 18 AWG | 10 | 0.34" | 0.29" | 0.90" | 0.74" | 0.030" | 0.070" | 0.145" | 100 | 500 |
| MV14-6FX | 051128-58738 | 16 - 14 AWG | 6 | 0.34" | 0.29" | 0.90" | 0.74" | 0.030" | 0.090" | 0.170" | 100 | 500 |
| MV14-6FK | 054007-01528 | 16 - 14 AWG | 6 | 0.34" | 0.29" | 0.90" | 0.74" | 0.030" | 0.090" | 0.170" | - | 1000 |
| MV14-8FX | 051128-58741 | 16 - 14 AWG | 8 | 0.34" | 0.29" | 0.90" | 0.74" | 0.030" | 0.090" | 0.170" | 100 | 500 |
| MV14-8FK | 054007-01530 | 16 - 14 AWG | 8 | 0.34" | 0.29" | 0.90" | 0.74" | 0.030" | 0.090" | 0.170" | - | 1000 |
| MV14-10FX | 051128-58742 | 16 - 14 AWG | 10 | 0.34" | 0.29" | 0.90" | 0.74" | 0.030" | 0.090" | 0.170" | 100 | 500 |
| MV14-10FK | 054007-01532 | 16 - 14 AWG | 10 | 0.34" | 0.29" | 0.90" | 0.74" | 0.030" | 0.090" | 0.170" | - | 1000 |
| MV10-6FX | 051128-58761 | 12 - 10 AWG | 6 | 0.38" | 0.29" | 1.03" | 0.84" | 0.040" | 0.135" | 0.250" | 50 | 500 |
| MV10-8FX | 051128-58762 | 12 - 10 AWG | 8 | 0.38" | 0.29" | 1.03" | 0.84" | 0.040" | 0.135" | 0.250" | 50 | 500 |
| MV10-8FK | 054007-01979 | 12 - 10 AWG | 8 | 0.38" | 0.29" | 1.03" | 0.84" | 0.040" | 0.135" | 0.250" | - | 500 |
| MV10-10FX | 051128-58763 | 12 - 10 AWG | 10 | 0.38" | 0.29" | 1.03" | 0.84" | 0.040" | 0.135" | 0.250" | 50 | 500 |
| MV10-10FK | 054007-01980 | 12 - 10 AWG | 10 | 0.38" | 0.29" | 1.03" | 0.84" | 0.040" | 0.135" | 0.250" | - | 500 |

Vinyl Insulated Butted Seam Standard Forks

Terminal Type Fork
 Terminal Style Standard
 Insulation Material Vinyl
 Barrel Style Butted
 RoHS 2011/65/EU Yes

Agency Approval



Manufacturing Origin



| Order No. | UPC | Conductor Size | Stud Size | (W) | (C) | (L) | (E) | Thickness | Barrel I.D. | Max. Insul. Dia. | Terminals per Carton | Terminals per Case |
|------------|--------------|----------------|-----------|-------|-------|-------|-------|-----------|-------------|------------------|----------------------|--------------------|
| MVU18-6FK | 054007-01174 | 22 - 18 AWG | 6 | 0.34" | 0.29" | 0.90" | 0.74" | 0.030" | 0.070" | 0.145" | - | 1000 |
| MVU18-6FX | 051128-59026 | 22 - 18 AWG | 6 | 0.34" | 0.29" | 0.90" | 0.74" | 0.030" | 0.070" | 0.145" | 100 | 500 |
| MVU18-8FK | 054007-01176 | 22 - 18 AWG | 8 | 0.34" | 0.29" | 0.90" | 0.74" | 0.030" | 0.070" | 0.145" | - | 1000 |
| MVU18-8FX | 051128-59027 | 22 - 18 AWG | 8 | 0.34" | 0.29" | 0.90" | 0.74" | 0.030" | 0.070" | 0.145" | 100 | 500 |
| MVU18-10FK | 054007-01178 | 22 - 18 AWG | 10 | 0.34" | 0.29" | 0.90" | 0.74" | 0.030" | 0.070" | 0.145" | - | 1000 |
| MVU18-10FX | 051128-59028 | 22 - 18 AWG | 10 | 0.34" | 0.29" | 0.90" | 0.74" | 0.030" | 0.070" | 0.145" | 100 | 500 |
| MVU14-6FK | 054007-01540 | 16 - 14 AWG | 6 | 0.34" | 0.29" | 0.90" | 0.74" | 0.030" | 0.090" | 0.170" | - | 1000 |
| MVU14-6FX | 051128-59029 | 16 - 14 AWG | 6 | 0.34" | 0.29" | 0.90" | 0.74" | 0.030" | 0.090" | 0.170" | 100 | 500 |
| MVU14-8FK | 054007-01542 | 16 - 14 AWG | 8 | 0.34" | 0.29" | 0.90" | 0.74" | 0.030" | 0.090" | 0.170" | - | 1000 |
| MVU14-8FX | 051128-59030 | 16 - 14 AWG | 8 | 0.34" | 0.29" | 0.90" | 0.74" | 0.030" | 0.090" | 0.170" | 100 | 500 |
| MVU14-10FK | 054007-01544 | 16 - 14 AWG | 10 | 0.34" | 0.29" | 0.90" | 0.74" | 0.030" | 0.090" | 0.170" | - | 1000 |
| MVU14-10FX | 051128-58883 | 16 - 14 AWG | 10 | 0.34" | 0.29" | 0.90" | 0.74" | 0.030" | 0.090" | 0.170" | 100 | 500 |
| MVU10-6FK | 054007-01984 | 12 - 10 AWG | 6 | 0.38" | 0.29" | 1.03" | 0.84" | 0.030" | 0.135" | 0.250" | - | 500 |
| MVU10-6FX | 051128-58856 | 12 - 10 AWG | 6 | 0.38" | 0.29" | 1.03" | 0.84" | 0.030" | 0.135" | 0.250" | 50 | 500 |
| MVU10-8FK | 054007-01985 | 12 - 10 AWG | 8 | 0.38" | 0.29" | 1.03" | 0.84" | 0.030" | 0.135" | 0.250" | - | 500 |
| MVU10-8FX | 051128-59031 | 12 - 10 AWG | 8 | 0.38" | 0.29" | 1.03" | 0.84" | 0.030" | 0.135" | 0.250" | 50 | 500 |
| MVU10-10FK | 054007-01986 | 12 - 10 AWG | 10 | 0.38" | 0.29" | 1.03" | 0.84" | 0.030" | 0.135" | 0.250" | - | 500 |
| MVU10-10FX | 051128-58884 | 12 - 10 AWG | 10 | 0.38" | 0.29" | 1.03" | 0.84" | 0.030" | 0.135" | 0.250" | 50 | 500 |

Non-Insulated Brazed Seam Standard Forks

| | |
|----------------------|---|
| Terminal Type | Fork |
| Terminal Style | Standard |
| Insulation Material | Non-Insulated |
| Barrel Style | Brazed |
| RoHS 2011/65/EU | Yes |
| Agency Approval |   |
| Manufacturing Origin |  |



| Order No. | UPC | Conductor Size | Stud Size | (W) | (C) | (L) | (E) | Thickness | Barrel I.D. | Terminals per Carton | Terminals per Case |
|-----------|--------------|----------------|-----------|-------|-------|-------|-------|-----------|-------------|----------------------|--------------------|
| M18-6FX | 051128-58655 | 22 - 18 AWG | 6 | 0.34" | 0.29" | 0.70" | 0.54" | 0.030" | 0.070" | 100 | 500 |
| M18-8FX | 051128-58657 | 22 - 18 AWG | 8 | 0.34" | 0.29" | 0.70" | 0.54" | 0.030" | 0.070" | 100 | 500 |
| M18-10FX | 051128-58947 | 22 - 18 AWG | 10 | 0.34" | 0.29" | 0.70" | 0.54" | 0.030" | 0.070" | 100 | 500 |
| M14-6FX | 051128-59024 | 16 - 14 AWG | 6 | 0.34" | 0.29" | 0.70" | 0.54" | 0.030" | 0.090" | 100 | 500 |
| M14-8FX | 051128-59025 | 16 - 14 AWG | 8 | 0.34" | 0.29" | 0.70" | 0.54" | 0.030" | 0.090" | 100 | 500 |
| M14-10FX | 051128-58664 | 16 - 14 AWG | 10 | 0.34" | 0.29" | 0.70" | 0.54" | 0.030" | 0.090" | 100 | 500 |
| M14-10FK | 054007-01520 | 16 - 14 AWG | 10 | 0.34" | 0.29" | 0.70" | 0.54" | 0.030" | 0.090" | - | 1000 |
| M10-6FX | 051128-58861 | 12 - 10 AWG | 6 | 0.38" | 0.29" | 0.73" | 0.54" | 0.040" | 0.135" | 50 | 500 |
| M10-6FK | 054007-01972 | 12 - 10 AWG | 6 | 0.38" | 0.29" | 0.73" | 0.54" | 0.040" | 0.135" | - | 500 |
| M10-8FX | 051128-58716 | 12 - 10 AWG | 8 | 0.38" | 0.29" | 0.73" | 0.54" | 0.040" | 0.135" | 50 | 500 |
| M10-8FK | 054007-01973 | 12 - 10 AWG | 8 | 0.38" | 0.29" | 0.73" | 0.54" | 0.040" | 0.135" | - | 500 |
| M10-10FX | 051128-58687 | 12 - 10 AWG | 10 | 0.38" | 0.29" | 0.73" | 0.54" | 0.040" | 0.135" | 50 | 500 |
| M10-10FK | 054007-01974 | 12 - 10 AWG | 10 | 0.38" | 0.29" | 0.73" | 0.54" | 0.040" | 0.135" | - | 500 |

Non-Insulated Butted Seam Standard Forks

| | |
|----------------------|---|
| Terminal Type | Fork |
| Terminal Style | Standard |
| Insulation Material | Non-Insulated |
| Barrel Style | Butted |
| RoHS 2011/65/EU | Yes |
| Agency Approval |   |
| Manufacturing Origin |  |



| Order No. | UPC | Conductor Size | Stud Size | (W) | (C) | (L) | (E) | Thickness | Barrel I.D. | Terminals per Carton | Terminals per Case |
|-----------|--------------|----------------|-----------|-------|-------|-------|-------|-----------|-------------|----------------------|--------------------|
| MU18-6FK | 054007-01144 | 22 - 18 AWG | 6 | 0.34" | 0.29" | 0.70" | 0.54" | 0.030" | 0.070" | - | 1000 |
| MU14-10FK | 054007-01514 | 16 - 14 AWG | 10 | 0.34" | 0.29" | 0.70" | 0.54" | 0.030" | 0.090" | - | 1000 |
| MU10-10FK | 054007-01971 | 12 - 10 AWG | 10 | 0.38" | 0.29" | 0.73" | 0.54" | 0.040" | 0.135" | - | 500 |

Nylon Insulated with Insulation Grip Block Forks

Terminal Type Fork
 Terminal Style Block
 Insulation Material Nylon with Insulation Grip
 Barrel Style Butted
 RoHS 2011/65/EU Yes

Agency Approval



Manufacturing Origin



| Order No. | UPC | Conductor Size | Stud Size | (W) | (C) | (L) | (E) | Thickness | Barrel I.D. | Max. Insul. Dia. | Terminals per Carton | Terminals per Case |
|--------------|--------------|----------------|-----------|-------|-------|-------|-------|-----------|-------------|------------------|----------------------|--------------------|
| MNG18-4FB/SK | 054007-02261 | 22 - 18 AWG | 4 | 0.25" | 0.25" | 0.84" | 0.69" | 0.030" | 0.070" | 0.145" | - | 1000 |
| MNG18-6FB/SX | 051128-58951 | 22 - 18 AWG | 6 | 0.25" | 0.25" | 0.84" | 0.69" | 0.030" | 0.070" | 0.145" | 100 | 500 |
| MNG18-6FB/SK | 054007-01214 | 22 - 18 AWG | 6 | 0.25" | 0.25" | 0.84" | 0.69" | 0.030" | 0.070" | 0.145" | - | 1000 |
| MNG18-6FBX | 051128-58652 | 22 - 18 AWG | 6 | 0.30" | 0.25" | 0.84" | 0.69" | 0.030" | 0.070" | 0.145" | 100 | 500 |
| MNG18-6FBK | 054007-01215 | 22 - 18 AWG | 6 | 0.30" | 0.25" | 0.84" | 0.69" | 0.030" | 0.070" | 0.145" | - | 1000 |
| MNG18-8FBX | 051128-58653 | 22 - 18 AWG | 8 | 0.30" | 0.25" | 0.84" | 0.69" | 0.030" | 0.070" | 0.145" | 100 | 500 |
| MNG18-8FBK | 054007-01216 | 22 - 18 AWG | 8 | 0.30" | 0.25" | 0.84" | 0.69" | 0.030" | 0.070" | 0.145" | - | 1000 |
| MNG18-10FBX | 051128-58654 | 22 - 18 AWG | 10 | 0.30" | 0.25" | 0.84" | 0.69" | 0.030" | 0.070" | 0.145" | 100 | 500 |
| MNG18-10FBK | 054007-01217 | 22 - 18 AWG | 10 | 0.30" | 0.25" | 0.84" | 0.69" | 0.030" | 0.070" | 0.145" | - | 1000 |
| MNG14-4FB/SK | 054007-02262 | 16 - 14 AWG | 4 | 0.25" | 0.25" | 0.86" | 0.71" | 0.030" | 0.090" | 0.170" | - | 1000 |
| MNG14-6FB/SX | 051128-58971 | 16 - 14 AWG | 6 | 0.25" | 0.25" | 0.86" | 0.71" | 0.030" | 0.090" | 0.170" | 100 | 500 |
| MNG14-6FB/SK | 054007-01580 | 16 - 14 AWG | 6 | 0.25" | 0.25" | 0.86" | 0.71" | 0.030" | 0.090" | 0.170" | - | 1000 |
| MNG14-6FBX | 051128-58712 | 16 - 14 AWG | 6 | 0.30" | 0.25" | 0.86" | 0.71" | 0.030" | 0.090" | 0.170" | 100 | 500 |
| MNG14-6FBK | 054007-01581 | 16 - 14 AWG | 6 | 0.30" | 0.25" | 0.86" | 0.71" | 0.030" | 0.090" | 0.170" | - | 1000 |
| MNG14-8FBX | 051128-58713 | 16 - 14 AWG | 8 | 0.30" | 0.25" | 0.86" | 0.71" | 0.030" | 0.090" | 0.170" | 100 | 500 |
| MNG14-8FBK | 054007-01582 | 16 - 14 AWG | 8 | 0.30" | 0.25" | 0.86" | 0.71" | 0.030" | 0.090" | 0.170" | - | 1000 |
| MNG14-10FBX | 051128-58705 | 16 - 14 AWG | 10 | 0.30" | 0.25" | 0.86" | 0.71" | 0.030" | 0.090" | 0.170" | 100 | 500 |
| MNG14-10FBK | 054007-01583 | 16 - 14 AWG | 10 | 0.30" | 0.25" | 0.86" | 0.71" | 0.030" | 0.090" | 0.170" | - | 1000 |
| MNG10-6FBX | 051128-58689 | 12 - 10 AWG | 6 | 0.32" | 0.29" | 1.03" | 0.84" | 0.040" | 0.135" | 0.250" | 50 | 500 |
| MNG10-6FBK | 054007-02017 | 12 - 10 AWG | 6 | 0.32" | 0.29" | 1.03" | 0.84" | 0.040" | 0.135" | 0.250" | - | 500 |
| MNG10-8FBX | 051128-58690 | 12 - 10 AWG | 8 | 0.32" | 0.29" | 1.03" | 0.84" | 0.040" | 0.135" | 0.250" | 50 | 500 |
| MNG10-8FBK | 054007-02018 | 12 - 10 AWG | 8 | 0.32" | 0.29" | 1.03" | 0.84" | 0.040" | 0.135" | 0.250" | - | 500 |
| MNG10-10FBX | 051128-58718 | 12 - 10 AWG | 10 | 0.32" | 0.29" | 1.03" | 0.84" | 0.040" | 0.135" | 0.250" | 50 | 500 |
| MNG10-10FBK | 054007-02019 | 12 - 10 AWG | 10 | 0.32" | 0.29" | 1.03" | 0.84" | 0.040" | 0.135" | 0.250" | - | 500 |

Vinyl Insulated Brazen Seam Block Forks

Terminal Type Fork
 Terminal Style Block
 Insulation Material Vinyl
 Barrel Style Brazen
 RoHS 2011/65/EU Yes



| Order No. | UPC | Conductor Size | Stud Size | (W) | (C) | (L) | (E) | Thickness | Barrel I.D. | Max. Insul. Dia. | Terminals per Carton | Terminals per Case |
|-------------|--------------|----------------|-----------|-------|-------|-------|-------|-----------|-------------|------------------|----------------------|--------------------|
| MV18-6FB/SX | 051128-58950 | 22 - 18 AWG | 6 | 0.25" | 0.25" | 0.85" | 0.70" | 0.030" | 0.070" | 0.145" | 100 | 500 |
| MV18-6FB/SK | 054007-01210 | 22 - 18 AWG | 6 | 0.25" | 0.25" | 0.85" | 0.70" | 0.030" | 0.070" | 0.145" | - | 1000 |
| MV18-6FBX | 051128-58743 | 22 - 18 AWG | 6 | 0.30" | 0.25" | 0.85" | 0.70" | 0.030" | 0.070" | 0.145" | 100 | 500 |
| MV18-6FBK | 054007-01211 | 22 - 18 AWG | 6 | 0.30" | 0.25" | 0.85" | 0.70" | 0.030" | 0.070" | 0.145" | - | 1000 |
| MV18-8FBX | 051128-58744 | 22 - 18 AWG | 8 | 0.30" | 0.25" | 0.85" | 0.70" | 0.030" | 0.070" | 0.145" | 100 | 500 |
| MV18-8FBK | 054007-01212 | 22 - 18 AWG | 8 | 0.30" | 0.25" | 0.85" | 0.70" | 0.030" | 0.070" | 0.145" | - | 1000 |
| MV18-10FBX | 051128-58745 | 22 - 18 AWG | 10 | 0.30" | 0.25" | 0.85" | 0.70" | 0.030" | 0.070" | 0.145" | 100 | 500 |
| MV18-10FBK | 054007-01213 | 22 - 18 AWG | 10 | 0.30" | 0.25" | 0.85" | 0.70" | 0.030" | 0.070" | 0.145" | - | 1000 |
| MV14-4FB/SK | 054007-02280 | 16 - 14 AWG | 4 | 0.25" | 0.25" | 0.85" | 0.70" | 0.030" | 0.090" | 0.170" | - | 1000 |
| MV14-6FB/SX | 051128-58970 | 16 - 14 AWG | 6 | 0.25" | 0.25" | 0.85" | 0.70" | 0.030" | 0.090" | 0.170" | 100 | 500 |
| MV14-6FB/SK | 054007-01576 | 16 - 14 AWG | 6 | 0.25" | 0.25" | 0.85" | 0.70" | 0.030" | 0.090" | 0.170" | - | 1000 |
| MV14-6FBX | 051128-58746 | 16 - 14 AWG | 6 | 0.30" | 0.25" | 0.85" | 0.70" | 0.030" | 0.090" | 0.170" | 100 | 500 |
| MV14-6FBK | 054007-01577 | 16 - 14 AWG | 6 | 0.30" | 0.25" | 0.85" | 0.70" | 0.030" | 0.090" | 0.170" | - | 1000 |
| MV14-8FBX | 051128-58747 | 16 - 14 AWG | 8 | 0.30" | 0.25" | 0.85" | 0.70" | 0.030" | 0.090" | 0.170" | 100 | 500 |
| MV14-8FBK | 054007-01578 | 16 - 14 AWG | 8 | 0.30" | 0.25" | 0.85" | 0.70" | 0.030" | 0.090" | 0.170" | - | 1000 |
| MV14-10FBX | 051128-58748 | 16 - 14 AWG | 10 | 0.30" | 0.25" | 0.85" | 0.70" | 0.030" | 0.090" | 0.170" | 100 | 500 |
| MV14-10FBK | 054007-01579 | 16 - 14 AWG | 10 | 0.30" | 0.25" | 0.85" | 0.70" | 0.030" | 0.090" | 0.170" | - | 1000 |
| MV10-6FBX | 051128-58764 | 12 - 10 AWG | 6 | 0.32" | 0.29" | 1.03" | 0.84" | 0.040" | 0.135" | 0.250" | 50 | 500 |
| MV10-6FBK | 054007-02014 | 12 - 10 AWG | 6 | 0.32" | 0.29" | 1.03" | 0.84" | 0.040" | 0.135" | 0.250" | - | 500 |
| MV10-8FBX | 051128-58765 | 12 - 10 AWG | 8 | 0.32" | 0.29" | 1.03" | 0.84" | 0.040" | 0.135" | 0.250" | 50 | 500 |
| MV10-8FBK | 054007-02015 | 12 - 10 AWG | 8 | 0.32" | 0.29" | 1.03" | 0.84" | 0.040" | 0.135" | 0.250" | - | 500 |
| MV10-10FBX | 051128-58766 | 12 - 10 AWG | 10 | 0.32" | 0.29" | 1.03" | 0.84" | 0.040" | 0.135" | 0.250" | 50 | 500 |
| MV10-10FBK | 054007-02016 | 12 - 10 AWG | 10 | 0.32" | 0.29" | 1.03" | 0.84" | 0.040" | 0.135" | 0.250" | - | 500 |

Vinyl Insulated Butted Seam Block Forks

Terminal Type Fork
 Terminal Style Block
 Insulation Material Vinyl
 Barrel Style Butted
 RoHS 2011/65/EU Yes

Agency Approval



Manufacturing Origin



| Order No. | UPC | Conductor Size | Stud Size | (W) | (C) | (L) | (E) | Thickness | Barrel I.D. | Max. Insul. Dia. | Terminals per Carton | Terminals per Case |
|--------------|--------------|----------------|-----------|-------|-------|-------|-------|-----------|-------------|------------------|----------------------|--------------------|
| MVU18-4FB/SK | 054007-02253 | 22 - 18 AWG | 4 | 0.25" | 0.25" | 0.85" | 0.70" | 0.030" | 0.070" | 0.145" | - | 1000 |
| MVU18-6FB/SK | 054007-01218 | 22 - 18 AWG | 6 | 0.25" | 0.25" | 0.85" | 0.70" | 0.030" | 0.070" | 0.145" | - | 1000 |
| MVU18-6FBX | 051128-58885 | 22 - 18 AWG | 6 | 0.30" | 0.25" | 0.85" | 0.70" | 0.030" | 0.070" | 0.145" | 100 | 500 |
| MVU18-6FBK | 054007-01219 | 22 - 18 AWG | 6 | 0.30" | 0.25" | 0.85" | 0.70" | 0.030" | 0.070" | 0.145" | - | 1000 |
| MVU18-8FBX | 051128-59032 | 22 - 18 AWG | 8 | 0.30" | 0.25" | 0.85" | 0.70" | 0.030" | 0.070" | 0.145" | 100 | 500 |
| MVU18-8FBK | 054007-01220 | 22 - 18 AWG | 8 | 0.30" | 0.25" | 0.85" | 0.70" | 0.030" | 0.070" | 0.145" | - | 1000 |
| MVU18-10FBX | 051128-58816 | 22 - 18 AWG | 10 | 0.30" | 0.25" | 0.85" | 0.70" | 0.030" | 0.070" | 0.145" | 100 | 500 |
| MVU18-10FBK | 054007-01221 | 22 - 18 AWG | 10 | 0.30" | 0.25" | 0.85" | 0.70" | 0.030" | 0.070" | 0.145" | - | 1000 |
| MVU14-4FB/SK | 054007-02258 | 16 - 14 AWG | 4 | 0.25" | 0.25" | 0.85" | 0.70" | 0.030" | 0.090" | 0.170" | - | 1000 |
| MVU14-6FB/SX | 051128-58886 | 16 - 14 AWG | 6 | 0.25" | 0.25" | 0.85" | 0.70" | 0.030" | 0.090" | 0.170" | 100 | 500 |
| MVU14-6FB/SK | 054007-01584 | 16 - 14 AWG | 6 | 0.25" | 0.25" | 0.85" | 0.70" | 0.030" | 0.090" | 0.170" | - | 1000 |
| MVU14-6FBX | 051128-58822 | 16 - 14 AWG | 6 | 0.30" | 0.25" | 0.85" | 0.70" | 0.030" | 0.090" | 0.170" | 100 | 500 |
| MVU14-6FBK | 054007-01585 | 16 - 14 AWG | 6 | 0.30" | 0.25" | 0.85" | 0.70" | 0.030" | 0.090" | 0.170" | - | 1000 |
| MVU14-8FBX | 051128-59033 | 16 - 14 AWG | 8 | 0.30" | 0.25" | 0.85" | 0.70" | 0.030" | 0.090" | 0.170" | 100 | 500 |
| MVU14-8FBK | 054007-01586 | 16 - 14 AWG | 8 | 0.30" | 0.25" | 0.85" | 0.70" | 0.030" | 0.090" | 0.170" | - | 1000 |
| MVU14-10FBX | 051128-59034 | 16 - 14 AWG | 10 | 0.30" | 0.25" | 0.85" | 0.70" | 0.030" | 0.090" | 0.170" | 100 | 500 |
| MVU14-10FBK | 054007-01587 | 16 - 14 AWG | 10 | 0.30" | 0.25" | 0.85" | 0.70" | 0.030" | 0.090" | 0.170" | - | 1000 |
| MVU10-6FBX | 051128-58855 | 12 - 10 AWG | 6 | 0.32" | 0.29" | 1.03" | 0.84" | 0.040" | 0.135" | 0.250" | 50 | 500 |
| MVU10-6FBK | 054007-02020 | 12 - 10 AWG | 6 | 0.32" | 0.29" | 1.03" | 0.84" | 0.040" | 0.135" | 0.250" | - | 500 |
| MVU10-8FBX | 051128-59035 | 12 - 10 AWG | 8 | 0.32" | 0.29" | 1.03" | 0.84" | 0.040" | 0.135" | 0.250" | 50 | 500 |
| MVU10-8FBK | 054007-02021 | 12 - 10 AWG | 8 | 0.32" | 0.29" | 1.03" | 0.84" | 0.040" | 0.135" | 0.250" | - | 500 |
| MVU10-10FBX | 051128-59036 | 12 - 10 AWG | 10 | 0.32" | 0.29" | 1.03" | 0.84" | 0.040" | 0.135" | 0.250" | 50 | 500 |
| MVU10-10FBK | 054007-02022 | 12 - 10 AWG | 10 | 0.32" | 0.29" | 1.03" | 0.84" | 0.040" | 0.135" | 0.250" | - | 500 |

Non-Insulated Brazed Seam Block Forks

Terminal Type Fork
 Terminal Style Block
 Insulation Material Non-Insulated
 Barrel Style Brazed
 RoHS 2011/65/EU Yes

Agency Approval



Manufacturing Origin



| Order No. | UPC | Conductor Size | Stud Size | (W) | (C) | (L) | (E) | Thickness | Barrel I.D. | Terminals per Carton | Terminals per Case |
|------------|--------------|----------------|-----------|-------|-------|-------|-------|-----------|-------------|----------------------|--------------------|
| M18-6FB/SX | 051128-58948 | 22 - 18 AWG | 6 | 0.25" | 0.25" | 0.65" | 0.50" | 0.030" | 0.070" | 100 | 500 |
| M18-6FBX | 051128-58645 | 22 - 18 AWG | 6 | 0.30" | 0.25" | 0.65" | 0.50" | 0.030" | 0.070" | 100 | 500 |
| M18-8FBK | 054007-01204 | 22 - 18 AWG | 8 | 0.30" | 0.25" | 0.65" | 0.50" | 0.030" | 0.070" | - | 1000 |
| M18-8FBX | 051128-58646 | 22 - 18 AWG | 8 | 0.30" | 0.25" | 0.65" | 0.50" | 0.030" | 0.070" | 100 | 500 |
| M18-10FBX | 051128-58949 | 22 - 18 AWG | 10 | 0.30" | 0.25" | 0.65" | 0.50" | 0.030" | 0.070" | 100 | 500 |
| M18-10FBK | 054007-01205 | 22 - 18 AWG | 10 | 0.30" | 0.25" | 0.65" | 0.50" | 0.030" | 0.070" | - | 1000 |
| M14-6FB/SK | 054007-01568 | 16 - 14 AWG | 6 | 0.25" | 0.25" | 0.65" | 0.50" | 0.030" | 0.090" | - | 1000 |
| M14-6FB/SX | 051128-58969 | 16 - 14 AWG | 6 | 0.25" | 0.25" | 0.65" | 0.50" | 0.030" | 0.090" | 100 | 500 |
| M14-6FBX | 054007-01569 | 16 - 14 AWG | 6 | 0.30" | 0.25" | 0.65" | 0.50" | 0.030" | 0.090" | - | 1000 |
| M14-6FBK | 051128-58668 | 16 - 14 AWG | 6 | 0.30" | 0.25" | 0.65" | 0.50" | 0.030" | 0.090" | 100 | 500 |
| M14-8FBK | 054007-01570 | 16 - 14 AWG | 8 | 0.30" | 0.25" | 0.65" | 0.50" | 0.030" | 0.090" | - | 1000 |
| M14-8FBX | 051128-58711 | 16 - 14 AWG | 8 | 0.30" | 0.25" | 0.65" | 0.50" | 0.030" | 0.090" | 100 | 500 |
| M14-10FBX | 051128-58669 | 16 - 14 AWG | 10 | 0.30" | 0.25" | 0.65" | 0.50" | 0.030" | 0.090" | 100 | 500 |
| M10-6FBK | 054007-02008 | 12 - 10 AWG | 6 | 0.32" | 0.29" | 0.73" | 0.54" | 0.040" | 0.135" | - | 500 |
| M10-6FBX | 051128-58862 | 12 - 10 AWG | 6 | 0.32" | 0.29" | 0.73" | 0.54" | 0.040" | 0.135" | 50 | 500 |
| M10-8FBK | 054007-02009 | 12 - 10 AWG | 8 | 0.32" | 0.29" | 0.73" | 0.54" | 0.040" | 0.135" | - | 500 |
| M10-8FBX | 051128-58719 | 12 - 10 AWG | 8 | 0.32" | 0.29" | 0.73" | 0.54" | 0.040" | 0.135" | 50 | 500 |
| M10-10FBK | 054007-02010 | 12 - 10 AWG | 10 | 0.32" | 0.29" | 0.73" | 0.54" | 0.040" | 0.135" | - | 500 |
| M10-10FBX | 051128-58720 | 12 - 10 AWG | 10 | 0.32" | 0.29" | 0.73" | 0.54" | 0.040" | 0.135" | 50 | 500 |

Non-Insulated Butted Seam Block Forks

| | |
|----------------------|---|
| Terminal Type | Fork |
| Terminal Style | Block |
| Insulation Material | Non-Insulated |
| Barrel Style | Butted |
| RoHS 2011/65/EU | Yes |
| Agency Approval |  |
| Manufacturing Origin |  |



| Order No. | UPC | Conductor Size | Stud Size | (W) | (C) | (L) | (E) | Thickness | Barrel I.D. | Terminals per Carton | Terminals per Case |
|-------------|--------------|----------------|-----------|-------|-------|-------|-------|-----------|-------------|----------------------|--------------------|
| MU18-4FB/SK | 054007-02263 | 22 - 18 AWG | 4 | 0.25" | 0.25" | 0.65" | 0.50" | 0.030" | 0.070" | - | 1000 |
| MU18-6FB/SK | 054007-01198 | 22 - 18 AWG | 6 | 0.25" | 0.25" | 0.65" | 0.50" | 0.030" | 0.070" | - | 1000 |
| MU18-6FBK | 054007-01199 | 22 - 18 AWG | 6 | 0.30" | 0.25" | 0.65" | 0.50" | 0.030" | 0.070" | - | 1000 |
| MU18-8FBK | 054007-01200 | 22 - 18 AWG | 8 | 0.30" | 0.25" | 0.65" | 0.50" | 0.030" | 0.070" | - | 1000 |
| MU18-10FBK | 054007-01201 | 22 - 18 AWG | 10 | 0.30" | 0.25" | 0.65" | 0.50" | 0.030" | 0.070" | - | 1000 |
| MU14-4FB/SK | 054007-02264 | 16 - 14 AWG | 4 | 0.25" | 0.25" | 0.65" | 0.50" | 0.030" | 0.090" | - | 1000 |
| MU14-6FB/SK | 054007-01564 | 16 - 14 AWG | 6 | 0.25" | 0.25" | 0.65" | 0.50" | 0.030" | 0.090" | - | 1000 |
| MU14-8FBK | 054007-01566 | 16 - 14 AWG | 8 | 0.30" | 0.25" | 0.65" | 0.50" | 0.030" | 0.090" | - | 1000 |
| MU14-10FBK | 054007-01567 | 16 - 14 AWG | 10 | 0.30" | 0.25" | 0.65" | 0.50" | 0.030" | 0.090" | - | 1000 |
| MU10-6FBK | 054007-02005 | 12 - 10 AWG | 6 | 0.32" | 0.29" | 0.73" | 0.54" | 0.040" | 0.135" | - | 500 |
| MU10-8FBK | 054007-02006 | 12 - 10 AWG | 8 | 0.32" | 0.29" | 0.73" | 0.54" | 0.040" | 0.135" | - | 500 |
| MU10-10FBK | 054007-02007 | 12 - 10 AWG | 10 | 0.32" | 0.29" | 0.73" | 0.54" | 0.040" | 0.135" | - | 500 |

3M™ Scotchlok™ Flanged Block Forks

Nylon Insulated with Insulation Grip Flanged Block Forks

Terminal Type Fork
 Terminal Style Flanged Block
 Insulation Material Nylon with Insulation Grip
 Barrel Style Butted
 RoHS 2011/65/EU Yes

Agency Approval



Manufacturing Origin



| Order No. | UPC | Conductor Size | Stud Size | (W) | (C) | (L) | (E) | Thickness | Barrel I.D. | Max. Insul. Dia. | Terminals per Carton | Terminals per Case |
|---------------|--------------|----------------|-----------|-------|-------|-------|-------|-----------|-------------|------------------|----------------------|--------------------|
| MNG18-6FFB/SX | 051128-58952 | 22 - 18 AWG | 6 | 0.25" | 0.25" | 0.84" | 0.69" | 0.030" | 0.070" | 0.145" | 100 | 500 |
| MNG18-6FFBK | 054007-01263 | 22 - 18 AWG | 6 | 0.30" | 0.25" | 0.84" | 0.69" | 0.030" | 0.070" | 0.145" | - | 1000 |
| MNG18-8FFBX | 051128-58953 | 22 - 18 AWG | 8 | 0.30" | 0.25" | 0.84" | 0.69" | 0.030" | 0.070" | 0.145" | 100 | 500 |
| MNG18-8FFBK | 054007-01264 | 22 - 18 AWG | 8 | 0.30" | 0.25" | 0.84" | 0.69" | 0.030" | 0.070" | 0.145" | - | 1000 |
| MNG18-10FFBX | 051128-58954 | 22 - 18 AWG | 10 | 0.30" | 0.25" | 0.84" | 0.69" | 0.030" | 0.070" | 0.145" | 100 | 500 |
| MNG18-10FFBK | 054007-01265 | 22 - 18 AWG | 10 | 0.30" | 0.25" | 0.84" | 0.69" | 0.030" | 0.070" | 0.145" | - | 1000 |
| MNG14-6FFB/SX | 051128-58972 | 16 - 14 AWG | 6 | 0.25" | 0.25" | 0.86" | 0.71" | 0.030" | 0.090" | 0.170" | 100 | 500 |
| MNG14-6FFBK | 054007-01629 | 16 - 14 AWG | 6 | 0.30" | 0.25" | 0.86" | 0.71" | 0.030" | 0.090" | 0.170" | - | 1000 |
| MNG14-8FFBX | 051128-58973 | 16 - 14 AWG | 8 | 0.30" | 0.25" | 0.86" | 0.71" | 0.030" | 0.090" | 0.170" | 100 | 500 |
| MNG14-8FFBK | 054007-01630 | 16 - 14 AWG | 8 | 0.30" | 0.25" | 0.86" | 0.71" | 0.030" | 0.090" | 0.170" | - | 1000 |
| MNG14-10FFBX | 051128-58974 | 16 - 14 AWG | 10 | 0.30" | 0.25" | 0.86" | 0.71" | 0.030" | 0.090" | 0.170" | 100 | 500 |
| MNG14-10FFBK | 054007-01631 | 16 - 14 AWG | 10 | 0.30" | 0.25" | 0.86" | 0.71" | 0.030" | 0.090" | 0.170" | - | 1000 |
| MNG10-6FFBX | 051128-58986 | 12 - 10 AWG | 6 | 0.32" | 0.29" | 1.03" | 0.84" | 0.040" | 0.135" | 0.250" | 50 | 500 |
| MNG10-8FFBX | 051128-58987 | 12 - 10 AWG | 8 | 0.32" | 0.29" | 1.03" | 0.84" | 0.040" | 0.135" | 0.250" | 50 | 500 |
| MNG10-8FFBK | 054007-02036 | 12 - 10 AWG | 8 | 0.32" | 0.29" | 1.03" | 0.84" | 0.040" | 0.135" | 0.250" | - | 500 |
| MNG10-10FFBX | 051128-58988 | 12 - 10 AWG | 10 | 0.32" | 0.29" | 1.03" | 0.84" | 0.040" | 0.135" | 0.250" | 50 | 500 |
| MNG10-10FFBK | 054007-02037 | 12 - 10 AWG | 10 | 0.32" | 0.29" | 1.03" | 0.84" | 0.040" | 0.135" | 0.250" | - | 500 |

Vinyl Insulated Butted Seam Flanged Block Forks

Terminal Type Fork
 Terminal Style Flanged Block
 Insulation Material Vinyl
 Barrel Style Butted
 RoHS 2011/65/EU Yes
 Agency Approval 
 Manufacturing Origin 



| Order No. | UPC | Conductor Size | Stud Size | (W) | (C) | (L) | (E) | Thickness | Barrel I.D. | Max. Insul. Dia. | Terminals per Carton | Terminals per Case |
|--------------|--------------|----------------|-----------|-------|-------|-------|-------|-----------|-------------|------------------|----------------------|--------------------|
| MVU18-6FFBK | 054007-01267 | 22 - 18 AWG | 6 | 0.30" | 0.25" | 0.85" | 0.70" | 0.030" | 0.070" | 0.145" | - | 1000 |
| MVU18-8FFBK | 054007-01268 | 22 - 18 AWG | 8 | 0.30" | 0.25" | 0.85" | 0.70" | 0.030" | 0.070" | 0.145" | - | 1000 |
| MVU18-10FFBK | 054007-01269 | 22 - 18 AWG | 10 | 0.30" | 0.25" | 0.85" | 0.70" | 0.030" | 0.070" | 0.145" | - | 1000 |
| MVU14-6FFBK | 054007-01633 | 16 - 14 AWG | 6 | 0.30" | 0.25" | 0.85" | 0.70" | 0.030" | 0.090" | 0.170" | - | 1000 |
| MVU14-8FFBK | 054007-01634 | 16 - 14 AWG | 8 | 0.30" | 0.25" | 0.85" | 0.70" | 0.030" | 0.090" | 0.170" | - | 1000 |
| MVU14-10FFBK | 054007-01635 | 16 - 14 AWG | 10 | 0.30" | 0.25" | 0.85" | 0.70" | 0.030" | 0.090" | 0.170" | - | 1000 |
| MVU10-6FFBK | 054007-02038 | 12 - 10 AWG | 6 | 0.32" | 0.29" | 1.03" | 0.84" | 0.040" | 0.135" | 0.250" | - | 500 |
| MVU10-8FFBK | 054007-02039 | 12 - 10 AWG | 8 | 0.32" | 0.29" | 1.03" | 0.84" | 0.040" | 0.135" | 0.250" | - | 500 |
| MVU10-10FFBK | 054007-02040 | 12 - 10 AWG | 10 | 0.32" | 0.29" | 1.03" | 0.84" | 0.040" | 0.135" | 0.250" | - | 500 |

Non-Insulated Brazed Seam Flanged Block Forks

Terminal Type Fork
 Terminal Style Flanged Block
 Insulation Material Non-Insulated
 Barrel Style Brazed
 RoHS 2011/65/EU Yes
 Agency Approval 
 Manufacturing Origin 



| Order No. | UPC | Conductor Size | Stud Size | (W) | (C) | (L) | (E) | Thickness | Barrel I.D. | Terminals per Carton | Terminals per Case |
|------------|--------------|----------------|-----------|-------|-------|-------|-------|-----------|-------------|----------------------|--------------------|
| M14-10FFBK | 054007-01619 | 16 - 14 AWG | 10 | 0.30" | 0.25" | 0.65" | 0.50" | 0.030" | 0.090" | - | 1000 |
| M10-10FFBK | 054007-02028 | 12 - 10 AWG | 10 | 0.32" | 0.29" | 0.73" | 0.54" | 0.040" | 0.135" | - | 500 |

3M™ Scotchlok™ Flanged Block Forks

Non-Insulated Butted Seam Flanged Block Forks

Terminal Type Fork
 Terminal Style Flanged Block
 Insulation Material Non-Insulated
 Barrel Style Butted
 RoHS 2011/65/EU Yes

Agency Approval



Manufacturing Origin



| Order No. | UPC | Conductor Size | Stud Size | (W) | (C) | (L) | (E) | Thickness | Barrel I.D. | Terminals per Carton | Terminals per Case |
|------------|--------------|----------------|-----------|-------|-------|-------|-------|-----------|-------------|----------------------|--------------------|
| MU18-6FFBK | 054007-01247 | 22 - 18 AWG | 6 | 0.30" | 0.25" | 0.65" | 0.50" | 0.030" | 0.070" | - | 1000 |
| MU14-8FFBK | 054007-01614 | 16 - 14 AWG | 8 | 0.30" | 0.25" | 0.65" | 0.50" | 0.030" | 0.090" | - | 1000 |
| MU10-8FFBK | 054007-02024 | 12 - 10 AWG | 8 | 0.32" | 0.29" | 0.73" | 0.54" | 0.040" | 0.135" | - | 500 |

3M™ Scotchlok™ Locking Forks

Heat Shrink Brazed Seam Locking Forks

Terminal Type Fork
 Terminal Style Locking
 Insulation Material Heat Shrink
 Barrel Style Brazed
 RoHS 2011/65/EU Yes

Manufacturing Origin

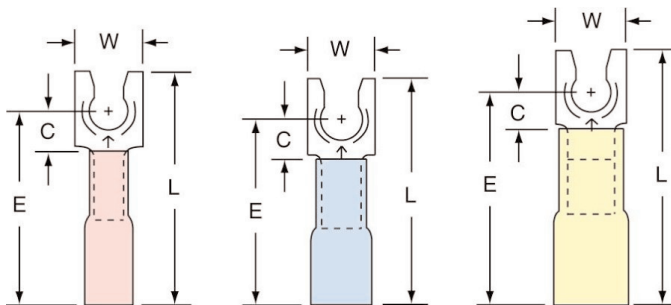

| Order No. | UPC | Conductor Size | Stud Size | (W) | (C) | (L) | (E) | Thickness | Barrel I.D. | Term. per Carton | Term. per Case |
|------------|--------------|----------------|-----------|-------|-------|-------|-------|-----------|-------------|------------------|----------------|
| MH18-6FLK | 054007-06347 | 22 - 18 AWG | 6 | 0.25" | 0.15" | 1.00" | 0.76" | 0.030" | 0.070" | - | 250 |
| MH18-6FLX | 051128-58911 | 22 - 18 AWG | 6 | 0.25" | 0.15" | 1.00" | 0.76" | 0.030" | 0.070" | 25 | 125 |
| MH18-8FLK | 054007-06362 | 22 - 18 AWG | 8 | 0.30" | 0.15" | 1.00" | 0.70" | 0.030" | 0.070" | - | 250 |
| MH18-8FLX | 051128-59096 | 22 - 18 AWG | 8 | 0.30" | 0.15" | 1.00" | 0.70" | 0.030" | 0.070" | 25 | 125 |
| MH18-10FLK | 054007-06353 | 22 - 18 AWG | 10 | 0.32" | 0.15" | 1.00" | 0.76" | 0.030" | 0.070" | - | 250 |
| MH18-10FLX | 051128-58915 | 22 - 18 AWG | 10 | 0.32" | 0.15" | 1.00" | 0.76" | 0.030" | 0.070" | 25 | 125 |
| MH14-6FLX | 051128-58899 | 16 - 14 AWG | 6 | 0.25" | 0.12" | 1.00" | 0.76" | 0.030" | 0.090" | 25 | 125 |
| MH14-6FLK | 054007-06323 | 16 - 14 AWG | 6 | 0.25" | 0.12" | 1.00" | 0.76" | 0.030" | 0.090" | - | 250 |
| MH14-8FLX | 051128-59094 | 16 - 14 AWG | 8 | 0.30" | 0.12" | 1.00" | 0.70" | 0.030" | 0.090" | 25 | 125 |
| MH14-8FLK | 054007-06360 | 16 - 14 AWG | 8 | 0.30" | 0.12" | 1.00" | 0.70" | 0.030" | 0.090" | - | 250 |
| MH14-10FLX | 051128-58902 | 16 - 14 AWG | 10 | 0.32" | 0.12" | 1.00" | 0.76" | 0.030" | 0.090" | 25 | 125 |

3M™ Scotchlok™ Locking Forks

Heat Shrink Brazed Seam Locking Forks (continued)

| Order No. | UPC | Conductor Size | Stud Size | (W) | (C) | (L) | (E) | Thickness | Barrel I.D. | Term. per Carton | Term. per Case |
|------------|--------------|----------------|-----------|-------|-------|-------|-------|-----------|-------------|------------------|----------------|
| MH14-10FLK | 054007-06329 | 16 - 14 AWG | 10 | 0.32" | 0.12" | 1.00" | 0.76" | 0.030" | 0.090" | - | 250 |
| MH14-14FLX | 051128-58904 | 16 - 14 AWG | 1/4" | 0.43" | 0.27" | 1.10" | 0.85" | 0.030" | 0.090" | 25 | 125 |
| MH14-14FLK | 054007-06333 | 16 - 14 AWG | 1/4" | 0.43" | 0.27" | 1.10" | 0.85" | 0.030" | 0.090" | - | 250 |
| MH10-8FLX | 051128-58889 | 12 - 10 AWG | 8 | 0.32" | 0.16" | 1.00" | 0.80" | 0.040" | 0.135" | 25 | 125 |
| MH10-8FLK | 054007-06358 | 12 - 10 AWG | 8 | 0.32" | 0.16" | 1.00" | 0.80" | 0.040" | 0.135" | - | 250 |
| MH10-10FLX | 051128-58891 | 12 - 10 AWG | 10 | 0.32" | 0.16" | 1.00" | 0.80" | 0.040" | 0.135" | 25 | 125 |
| MH10-10FLK | 054007-06308 | 12 - 10 AWG | 10 | 0.32" | 0.16" | 1.00" | 0.80" | 0.040" | 0.135" | - | 250 |
| MH10-14FLX | 051128-58893 | 12 - 10 AWG | 1/4" | 0.43" | 0.30" | 1.20" | 0.95" | 0.040" | 0.135" | 25 | 125 |
| MH10-14FLK | 054007-06311 | 12 - 10 AWG | 1/4" | 0.43" | 0.30" | 1.20" | 0.95" | 0.040" | 0.135" | - | 250 |

Nylon Insulated with Insulation Grip Locking Forks

- Terminal Type: Fork
- Terminal Style: Locking
- Insulation Material: Nylon with Insulation Grip
- Barrel Style: Butted
- RoHS 2011/65/EU: Yes
- Agency Approval: 

Manufacturing Origin



| Order No. | UPC | Conductor Size | Stud Size | Max. Lock Width | (W) | (C) | (L) | (E) | Thickness | Barrel I.D. | Max. Insul. Dia. | Term. per Carton | Term. per Case |
|-------------|--------------|----------------|-----------|-----------------|-------|-------|-------|-------|-----------|-------------|------------------|------------------|----------------|
| MNG18-4FLX | 051128-58810 | 22 - 18 AWG | 4 | 0.27" | 0.25" | 0.25" | 0.87" | 0.69" | 0.030" | 0.070" | 0.145" | 100 | 500 |
| MNG18-4FLK | 054007-01355 | 22 - 18 AWG | 4 | 0.27" | 0.25" | 0.25" | 0.87" | 0.69" | 0.030" | 0.070" | 0.145" | - | 1000 |
| MNG18-6FLX | 051128-58804 | 22 - 18 AWG | 6 | 0.27" | 0.25" | 0.25" | 0.87" | 0.69" | 0.030" | 0.070" | 0.145" | 100 | 500 |
| MNG18-6FLK | 054007-01356 | 22 - 18 AWG | 6 | 0.27" | 0.25" | 0.25" | 0.87" | 0.69" | 0.030" | 0.070" | 0.145" | - | 1000 |
| MNG18-8FLX | 051128-58805 | 22 - 18 AWG | 8 | 0.34" | 0.30" | 0.25" | 0.87" | 0.69" | 0.030" | 0.070" | 0.145" | 100 | 500 |
| MNG18-8FLK | 054007-01357 | 22 - 18 AWG | 8 | 0.34" | 0.30" | 0.25" | 0.87" | 0.69" | 0.030" | 0.070" | 0.145" | - | 1000 |
| MNG18-10FLX | 051128-58806 | 22 - 18 AWG | 10 | 0.35" | 0.32" | 0.25" | 0.87" | 0.69" | 0.030" | 0.070" | 0.145" | 100 | 500 |
| MNG18-10FLK | 054007-01358 | 22 - 18 AWG | 10 | 0.35" | 0.32" | 0.25" | 0.87" | 0.69" | 0.030" | 0.070" | 0.145" | - | 1000 |
| MNG14-4FLX | 051128-58801 | 16 - 14 AWG | 4 | 0.27" | 0.25" | 0.25" | 0.89" | 0.71" | 0.030" | 0.090" | 0.170" | 100 | 500 |
| MNG14-6FLX | 051128-58802 | 16 - 14 AWG | 6 | 0.27" | 0.24" | 0.25" | 0.89" | 0.71" | 0.030" | 0.090" | 0.170" | 100 | 500 |
| MNG14-6FLK | 054007-01867 | 16 - 14 AWG | 6 | 0.27" | 0.24" | 0.25" | 0.89" | 0.71" | 0.030" | 0.090" | 0.170" | - | 1000 |
| MNG14-8FLX | 051128-58796 | 16 - 14 AWG | 8 | 0.34" | 0.30" | 0.25" | 0.89" | 0.71" | 0.030" | 0.090" | 0.170" | 100 | 500 |
| MNG14-8FLK | 054007-01868 | 16 - 14 AWG | 8 | 0.34" | 0.30" | 0.25" | 0.89" | 0.71" | 0.030" | 0.090" | 0.170" | - | 1000 |
| MNG14-10FLX | 051128-58797 | 16 - 14 AWG | 10 | 0.35" | 0.32" | 0.25" | 0.89" | 0.71" | 0.030" | 0.090" | 0.170" | 100 | 500 |
| MNG14-10FLK | 054007-01869 | 16 - 14 AWG | 10 | 0.35" | 0.32" | 0.25" | 0.89" | 0.71" | 0.030" | 0.090" | 0.170" | - | 1000 |
| MNG14-14FLX | 051128-58798 | 16 - 14 AWG | 1/4" | 0.48" | 0.43" | 0.40" | 1.11" | 0.86" | 0.030" | 0.090" | 0.170" | 100 | 500 |
| MNG10-6FLK | 054007-02106 | 12 - 10 AWG | 6 | 0.30" | 0.28" | 0.28" | 1.03" | 0.83" | 0.040" | 0.135" | 0.250" | - | 500 |
| MNG10-6FLX | 051128-58794 | 12 - 10 AWG | 6 | 0.30" | 0.28" | 0.28" | 1.03" | 0.83" | 0.040" | 0.135" | 0.250" | 50 | 500 |

3M™ Scotchlok™ Locking Forks

Nylon Insulated with Insulation Grip Locking Forks (continued)

| Order No. | UPC | Conductor Size | Stud Size | Max. Lock Width | (W) | (C) | (L) | (E) | Thickness | Barrel I.D. | Max. Insul. Dia. | Term. per Carton | Term. per Case |
|-------------|--------------|----------------|-----------|-----------------|-------|-------|-------|-------|-----------|-------------|------------------|------------------|----------------|
| MNG10-8FLK | 054007-02107 | 12 - 10 AWG | 8 | 0.35" | 0.32" | 0.28" | 1.03" | 0.83" | 0.040" | 0.135" | 0.250" | - | 500 |
| MNG10-8FLX | 051128-58795 | 12 - 10 AWG | 8 | 0.35" | 0.32" | 0.28" | 1.03" | 0.83" | 0.040" | 0.135" | 0.250" | 50 | 500 |
| MNG10-10FLK | 054007-02108 | 12 - 10 AWG | 10 | 0.36" | 0.32" | 0.28" | 1.03" | 0.83" | 0.040" | 0.135" | 0.250" | - | 500 |
| MNG10-10FLX | 051128-58791 | 12 - 10 AWG | 10 | 0.36" | 0.32" | 0.28" | 1.03" | 0.83" | 0.040" | 0.135" | 0.250" | 50 | 500 |
| MNG10-14FLK | 054007-02109 | 12 - 10 AWG | 1/4" | 0.48" | 0.43" | 0.44" | 1.24" | 0.99" | 0.040" | 0.135" | 0.250" | - | 500 |
| MNG10-14FLX | 051128-58792 | 12 - 10 AWG | 1/4" | 0.48" | 0.43" | 0.44" | 1.24" | 0.99" | 0.040" | 0.135" | 0.250" | 50 | 500 |

Vinyl Insulated Brazed Seam Locking Forks

Terminal Type Fork
 Terminal Style Locking
 Insulation Material Vinyl
 Barrel Style Brazed
 RoHS 2011/65/EU Yes

Agency Approval



Manufacturing Origin



| Order No. | UPC | Conductor Size | Stud Size | Max. Lock Width | (W) | (C) | (L) | (E) | Thickness | Barrel I.D. | Max. Insul. Dia. | Term. per Carton | Term. per Case |
|------------|--------------|----------------|-----------|-----------------|-------|-------|-------|-------|-----------|-------------|------------------|------------------|----------------|
| MV18-4FLX | 051128-58849 | 22 - 18 AWG | 4 | 0.27" | 0.25" | 0.25" | 0.88" | 0.70" | 0.030" | 0.070" | 0.145" | 100 | 500 |
| MV18-4FLK | 054007-13857 | 22 - 18 AWG | 4 | 0.27" | 0.25" | 0.25" | 0.88" | 0.70" | 0.030" | 0.070" | 0.145" | - | 1000 |
| MV18-6FLX | 051128-58846 | 22 - 18 AWG | 6 | 0.27" | 0.25" | 0.25" | 0.88" | 0.70" | 0.030" | 0.070" | 0.145" | 100 | 500 |
| MV18-6FLK | 054007-13865 | 22 - 18 AWG | 6 | 0.27" | 0.25" | 0.25" | 0.88" | 0.70" | 0.030" | 0.070" | 0.145" | - | 1000 |
| MV18-8FLX | 051128-58847 | 22 - 18 AWG | 8 | 0.34" | 0.30" | 0.25" | 0.88" | 0.70" | 0.030" | 0.070" | 0.145" | 100 | 500 |
| MV18-8FLK | 054007-13873 | 22 - 18 AWG | 8 | 0.34" | 0.30" | 0.25" | 0.88" | 0.70" | 0.030" | 0.070" | 0.145" | - | 1000 |
| MV18-10FLX | 051128-58844 | 22 - 18 AWG | 10 | 0.35" | 0.32" | 0.25" | 0.88" | 0.70" | 0.030" | 0.070" | 0.145" | 100 | 500 |
| MV18-10FLK | 054007-13891 | 22 - 18 AWG | 10 | 0.35" | 0.32" | 0.25" | 0.88" | 0.70" | 0.030" | 0.070" | 0.145" | - | 1000 |
| MV14-4FLX | 051128-58838 | 16 - 14 AWG | 4 | 0.27" | 0.25" | 0.25" | 0.88" | 0.70" | 0.030" | 0.090" | 0.170" | 100 | 500 |
| MV14-6FLX | 051128-58839 | 16 - 14 AWG | 6 | 0.27" | 0.25" | 0.25" | 0.88" | 0.70" | 0.030" | 0.090" | 0.170" | 100 | 500 |
| MV14-6FLK | 054007-13907 | 16 - 14 AWG | 6 | 0.27" | 0.25" | 0.25" | 0.88" | 0.70" | 0.030" | 0.090" | 0.170" | - | 1000 |
| MV14-8FLX | 051128-58836 | 16 - 14 AWG | 8 | 0.34" | 0.30" | 0.25" | 0.88" | 0.70" | 0.030" | 0.090" | 0.170" | 100 | 500 |
| MV14-8FLK | 054007-13915 | 16 - 14 AWG | 8 | 0.34" | 0.30" | 0.25" | 0.88" | 0.70" | 0.030" | 0.090" | 0.170" | - | 1000 |
| MV14-10FLX | 051128-58837 | 16 - 14 AWG | 10 | 0.35" | 0.32" | 0.25" | 0.88" | 0.70" | 0.030" | 0.090" | 0.170" | 100 | 500 |
| MV14-10FLK | 054007-13923 | 16 - 14 AWG | 10 | 0.35" | 0.32" | 0.25" | 0.88" | 0.70" | 0.030" | 0.090" | 0.170" | - | 1000 |
| MV14-14FLX | 051128-58835 | 16 - 14 AWG | 1/4" | 0.48" | 0.43" | 0.40" | 1.10" | 0.85" | 0.030" | 0.090" | 0.170" | 100 | 500 |
| MV10-6FLX | 051128-58832 | 12 - 10 AWG | 6 | 0.30" | 0.28" | 0.28" | 1.03" | 0.83" | 0.040" | 0.135" | 0.250" | 50 | 500 |
| MV10-6FLK | 054007-13949 | 12 - 10 AWG | 6 | 0.30" | 0.28" | 0.28" | 1.03" | 0.83" | 0.040" | 0.135" | 0.250" | - | 500 |
| MV10-8FLX | 051128-58829 | 12 - 10 AWG | 8 | 0.35" | 0.32" | 0.28" | 1.03" | 0.83" | 0.040" | 0.135" | 0.250" | 50 | 500 |
| MV10-8FLK | 054007-13956 | 12 - 10 AWG | 8 | 0.35" | 0.32" | 0.28" | 1.03" | 0.83" | 0.040" | 0.135" | 0.250" | - | 500 |
| MV10-10FLX | 051128-58830 | 12 - 10 AWG | 10 | 0.36" | 0.32" | 0.28" | 1.03" | 0.83" | 0.040" | 0.135" | 0.250" | 50 | 500 |
| MV10-10FLK | 054007-13964 | 12 - 10 AWG | 10 | 0.36" | 0.32" | 0.28" | 1.03" | 0.83" | 0.040" | 0.135" | 0.250" | - | 500 |
| MV10-14FLX | 051128-58828 | 12 - 10 AWG | 1/4" | 0.48" | 0.43" | 0.44" | 1.24" | 0.99" | 0.040" | 0.135" | 0.250" | 50 | 500 |
| MV10-14FLK | 054007-13972 | 12 - 10 AWG | 1/4" | 0.48" | 0.43" | 0.44" | 1.24" | 0.99" | 0.040" | 0.135" | 0.250" | - | 500 |

Vinyl Insulated Butted Seam Locking Forks

Terminal Type Fork
Terminal Style Locking
Insulation Material Vinyl
Barrel Style Butted
RoHS 2011/65/EU Yes
Agency Approval 
Manufacturing Origin 



| Order No. | UPC | Conductor Size | Stud Size | Max. Lock Width | (W) | (C) | (L) | (E) | Thickness | Barrel I.D. | Max. Insul. Dia. | Term. per Carton | Term. per Case |
|-------------|--------------|----------------|-----------|-----------------|-------|-------|-------|-------|-----------|-------------|------------------|------------------|----------------|
| MVU18-4FLK | 054007-01359 | 22 - 18 AWG | 4 | 0.27" | 0.25" | 0.25" | 0.88" | 0.70" | 0.030" | 0.070" | 0.145" | - | 1000 |
| MVU18-6FLK | 054007-01360 | 22 - 18 AWG | 6 | 0.27" | 0.25" | 0.25" | 0.88" | 0.70" | 0.030" | 0.070" | 0.145" | - | 1000 |
| MVU18-8FLK | 054007-01361 | 22 - 18 AWG | 8 | 0.34" | 0.30" | 0.25" | 0.88" | 0.70" | 0.030" | 0.070" | 0.145" | - | 1000 |
| MVU18-10FLK | 054007-01362 | 22 - 18 AWG | 10 | 0.35" | 0.32" | 0.25" | 0.88" | 0.70" | 0.030" | 0.070" | 0.145" | - | 1000 |
| MVU14-4FLK | 054007-01871 | 16 - 14 AWG | 4 | 0.27" | 0.25" | 0.25" | 0.88" | 0.70" | 0.030" | 0.090" | 0.170" | - | 1000 |
| MVU14-6FLK | 054007-01872 | 16 - 14 AWG | 6 | 0.27" | 0.25" | 0.25" | 0.88" | 0.70" | 0.030" | 0.090" | 0.170" | - | 1000 |
| MVU14-8FLK | 054007-01873 | 16 - 14 AWG | 8 | 0.34" | 0.30" | 0.25" | 0.88" | 0.70" | 0.030" | 0.090" | 0.170" | - | 1000 |
| MVU14-10FLK | 054007-01874 | 16 - 14 AWG | 10 | 0.35" | 0.32" | 0.25" | 0.88" | 0.70" | 0.030" | 0.090" | 0.170" | - | 1000 |
| MVU14-14FLK | 054007-01875 | 16 - 14 AWG | 1/4" | 0.48" | 0.43" | 0.40" | 1.10" | 0.85" | 0.030" | 0.090" | 0.170" | - | 1000 |
| MVU10-6FLK | 054007-02114 | 12 - 10 AWG | 6 | 0.30" | 0.28" | 0.28" | 1.03" | 0.83" | 0.040" | 0.135" | 0.250" | - | 500 |
| MVU10-8FLK | 054007-02115 | 12 - 10 AWG | 8 | 0.35" | 0.32" | 0.28" | 1.03" | 0.83" | 0.040" | 0.135" | 0.250" | - | 500 |
| MVU10-10FLK | 054007-02116 | 12 - 10 AWG | 10 | 0.36" | 0.32" | 0.28" | 1.03" | 0.83" | 0.040" | 0.135" | 0.250" | - | 500 |
| MVU10-14FLK | 054007-02117 | 12 - 10 AWG | 1/4" | 0.48" | 0.43" | 0.44" | 1.24" | 0.99" | 0.040" | 0.135" | 0.250" | - | 500 |

Non-Insulated Brazed Seam Locking Forks

| | |
|----------------------|---|
| Terminal Type | Fork |
| Terminal Style | Locking |
| Insulation Material | Non-Insulated |
| Barrel Style | Brazed |
| RoHS 2011/65/EU | Yes |
| Agency Approval |   |
| Manufacturing Origin |  |



| Order No. | UPC | Conductor Size | Stud Size | Max. Lock Width | (W) | (C) | (L) | (E) | Thickness | Barrel I.D. | Term. per Carton | Term. per Case |
|-----------|--------------|----------------|-----------|-----------------|-------|-------|-------|-------|-----------|-------------|------------------|----------------|
| M18-6FLK | 054007-13733 | 22 - 18 AWG | 6 | 0.27" | 0.25" | 0.25" | 0.68" | 0.50" | 0.030" | 0.070" | - | 1000 |
| M18-6FLX | 051128-58850 | 22 - 18 AWG | 6 | 0.27" | 0.25" | 0.25" | 0.68" | 0.50" | 0.030" | 0.070" | 100 | 500 |
| M18-8FLX | 051128-58851 | 22 - 18 AWG | 8 | 0.34" | 0.30" | 0.25" | 0.68" | 0.50" | 0.030" | 0.070" | 100 | 500 |
| M18-10FLX | 051128-58848 | 22 - 18 AWG | 10 | 0.35" | 0.32" | 0.25" | 0.68" | 0.50" | 0.030" | 0.070" | 100 | 500 |
| M14-6FLK | 054007-13775 | 16 - 14 AWG | 6 | 0.27" | 0.25" | 0.25" | 0.68" | 0.50" | 0.030" | 0.090" | - | 1000 |
| M14-6FLX | 051128-58842 | 16 - 14 AWG | 6 | 0.27" | 0.25" | 0.25" | 0.68" | 0.50" | 0.030" | 0.090" | 100 | 500 |
| M14-8FLX | 051128-58843 | 16 - 14 AWG | 8 | 0.34" | 0.30" | 0.25" | 0.68" | 0.50" | 0.030" | 0.090" | 100 | 500 |
| M14-10FLK | 054007-13800 | 16 - 14 AWG | 10 | 0.35" | 0.32" | 0.25" | 0.68" | 0.50" | 0.030" | 0.090" | - | 1000 |
| M14-10FLX | 051128-58840 | 16 - 14 AWG | 10 | 0.35" | 0.32" | 0.25" | 0.68" | 0.50" | 0.030" | 0.090" | 100 | 500 |
| M14-14FLX | 051128-58841 | 16 - 14 AWG | 1/4" | 0.48" | 0.43" | 0.40" | 0.90" | 0.65" | 0.030" | 0.090" | 100 | 500 |
| M10-8FLX | 051128-58833 | 12 - 10 AWG | 8 | 0.35" | 0.32" | 0.28" | 0.73" | 0.53" | 0.040" | 0.135" | 50 | 500 |
| M10-10FLX | 051128-58834 | 12 - 10 AWG | 10 | 0.36" | 0.32" | 0.28" | 0.73" | 0.53" | 0.040" | 0.135" | 50 | 500 |
| M10-10FLK | 054007-13832 | 12 - 10 AWG | 10 | 0.36" | 0.32" | 0.28" | 0.73" | 0.53" | 0.040" | 0.135" | - | 500 |
| M10-14FLX | 051128-58831 | 12 - 10 AWG | 1/4" | 0.48" | 0.43" | 0.44" | 0.94" | 0.69" | 0.040" | 0.135" | 50 | 500 |
| M10-14FLK | 054007-13850 | 12 - 10 AWG | 1/4" | 0.48" | 0.43" | 0.44" | 0.94" | 0.69" | 0.040" | 0.135" | - | 500 |

Non-Insulated Butted Seam Locking Forks

Terminal Type Fork
 Terminal Style Locking
 Insulation Material Non-Insulated
 Barrel Style Butted
 RoHS 2011/65/EU Yes

Agency Approval



Manufacturing Origin

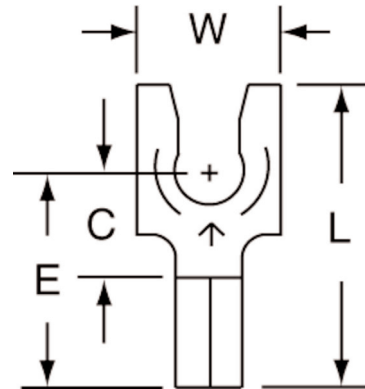

| Order No. | UPC | Conductor Size | Stud Size | Max. Lock Width | (W) | (C) | (L) | (E) | Thickness | Barrel I.D. | Term. per Carton | Term. per Case |
|------------|--------------|----------------|-----------|-----------------|-------|-------|-------|-------|-----------|-------------|------------------|----------------|
| MU18-4FLK | 054007-01347 | 22 - 18 AWG | 4 | 0.27" | 0.25" | 0.25" | 0.68" | 0.50" | 0.030" | 0.070" | - | 1000 |
| MU18-6FLK | 054007-01348 | 22 - 18 AWG | 6 | 0.27" | 0.25" | 0.25" | 0.68" | 0.50" | 0.030" | 0.070" | - | 1000 |
| MU18-6FLX | 051128-59015 | 22 - 18 AWG | 6 | 0.27" | 0.25" | 0.25" | 0.68" | 0.50" | 0.030" | 0.070" | 100 | 500 |
| MU18-8FLK | 054007-01349 | 22 - 18 AWG | 8 | 0.34" | 0.30" | 0.25" | 0.68" | 0.50" | 0.030" | 0.070" | - | 1000 |
| MU18-8FLX | 051128-59016 | 22 - 18 AWG | 8 | 0.34" | 0.30" | 0.25" | 0.68" | 0.50" | 0.030" | 0.070" | 100 | 500 |
| MU18-10FLK | 054007-01350 | 22 - 18 AWG | 10 | 0.35" | 0.32" | 0.25" | 0.68" | 0.50" | 0.030" | 0.070" | - | 1000 |
| MU18-10FLX | 051128-59017 | 22 - 18 AWG | 10 | 0.35" | 0.32" | 0.25" | 0.68" | 0.50" | 0.030" | 0.070" | 100 | 500 |
| MU14-6FLK | 054007-01857 | 16 - 14 AWG | 6 | 0.27" | 0.25" | 0.25" | 0.68" | 0.50" | 0.030" | 0.090" | - | 1000 |
| MU14-6FLX | 051128-59018 | 16 - 14 AWG | 6 | 0.27" | 0.25" | 0.25" | 0.68" | 0.50" | 0.030" | 0.090" | 100 | 500 |
| MU14-8FLK | 054007-01858 | 16 - 14 AWG | 8 | 0.34" | 0.30" | 0.25" | 0.68" | 0.50" | 0.030" | 0.090" | - | 1000 |
| MU14-8FLX | 051128-59019 | 16 - 14 AWG | 8 | 0.34" | 0.30" | 0.25" | 0.68" | 0.50" | 0.030" | 0.090" | 100 | 500 |
| MU14-10FLK | 054007-01859 | 16 - 14 AWG | 10 | 0.35" | 0.32" | 0.25" | 0.68" | 0.50" | 0.030" | 0.090" | - | 1000 |
| MU14-10FLX | 051128-59020 | 16 - 14 AWG | 10 | 0.35" | 0.32" | 0.25" | 0.68" | 0.50" | 0.030" | 0.090" | 100 | 500 |
| MU14-14FLK | 054007-01860 | 16 - 14 AWG | 1/4" | 0.48" | 0.43" | 0.40" | 0.90" | 0.65" | 0.030" | 0.090" | - | 1000 |
| MU10-8FLK | 054007-02103 | 12 - 10 AWG | 8 | 0.35" | 0.32" | 0.28" | 0.73" | 0.53" | 0.040" | 0.135" | - | 500 |
| MU10-8FLX | 051128-59021 | 12 - 10 AWG | 8 | 0.35" | 0.32" | 0.28" | 0.73" | 0.53" | 0.040" | 0.135" | 100 | 500 |
| MU10-10FLK | 054007-02104 | 12 - 10 AWG | 10 | 0.36" | 0.32" | 0.28" | 0.73" | 0.53" | 0.040" | 0.135" | - | 500 |
| MU10-10FLX | 051128-59022 | 12 - 10 AWG | 10 | 0.36" | 0.32" | 0.28" | 0.73" | 0.53" | 0.040" | 0.135" | 50 | 500 |
| MU10-14FLK | 054007-02105 | 12 - 10 AWG | 1/4" | 0.48" | 0.43" | 0.44" | 0.94" | 0.69" | 0.040" | 0.135" | - | 500 |
| MU10-14FLX | 051128-59023 | 12 - 10 AWG | 1/4" | 0.48" | 0.43" | 0.44" | 0.94" | 0.69" | 0.040" | 0.135" | 50 | 500 |

3M™ Scotchlok™ Butt Connectors

Heat Shrink Seamless Butt Connectors

Terminal Type: Butt
 Terminal Style: Standard
 Insulation Material: Heat Shrink
 Barrel Style: Seamless
 RoHS 2011/65/EU: Yes

Manufacturing Origin



| Order No. | UPC | Conductor Size | (L) | Thickness | Barrel Length | Barrel I.D. | Terminals per Carton | Terminals per Case |
|-----------|--------------|----------------|-------|-----------|---------------|-------------|----------------------|--------------------|
| MH18BCK | 054007-06343 | 22 - 18 AWG | 1.20" | 0.031" | 0.28" | 0.062" | - | 250 |
| MH18BCX | 051128-58909 | 22 - 18 AWG | 1.20" | 0.031" | 0.28" | 0.062" | 25 | 125 |
| MH14BCK | 054007-06319 | 16 - 14 AWG | 1.30" | 0.031" | 0.30" | 0.095" | - | 250 |
| MH14BCX | 051128-58897 | 16 - 14 AWG | 1.30" | 0.031" | 0.30" | 0.095" | 25 | 125 |
| MH10BCK | 054007-06301 | 12 - 10 AWG | 1.50" | 0.031" | 0.38" | 0.142" | - | 250 |
| MH10BCX | 051128-59093 | 12 - 10 AWG | 1.50" | 0.031" | 0.38" | 0.142" | 25 | 125 |

Nylon Insulated Seamless Butt Connectors

Terminal Type: Butt
 Terminal Style: Standard
 Insulation Material: Nylon
 Barrel Style: Seamless
 RoHS 2011/65/EU: Yes

Agency Approval



Except for MN24 Butt Connectors



| Order No. | UPC | Conductor Size | (L) | Thickness | Barrel Length | Barrel I.D. | Max. Insul. Dia. | Terminals per Carton | Terminals per Case |
|-----------|--------------|----------------|-------|-----------|---------------|-------------|------------------|----------------------|--------------------|
| MN18BCK-A | 054007-15983 | 22 - 18 AWG | 1.02" | 0.031" | 0.28" | 0.062" | 0.125" | - | 10000 |
| MN18BCX | 051128-58647 | 22 - 18 AWG | 1.02" | 0.031" | 0.28" | 0.062" | 0.125" | 100 | 500 |
| MN18BCX-A | 051128-58999 | 22 - 18 AWG | 1.02" | 0.031" | 0.28" | 0.062" | 0.125" | 100 | 500 |
| MN14BCK-A | 054007-01819 | 16 - 14 AWG | 1.02" | 0.031" | 0.30" | 0.095" | 0.155" | - | 8000 |
| MN14BCX | 051128-58680 | 16 - 14 AWG | 1.02" | 0.031" | 0.30" | 0.095" | 0.155" | 100 | 500 |
| MN14BCX-A | 051128-59000 | 16 - 14 AWG | 1.02" | 0.031" | 0.30" | 0.095" | 0.155" | 100 | 500 |
| MN10BCK-A | 054007-02080 | 12 - 10 AWG | 1.20" | 0.038" | 0.38" | 0.142" | 0.218" | - | 4000 |
| MN10BCX | 051128-58723 | 12 - 10 AWG | 1.20" | 0.038" | 0.38" | 0.142" | 0.218" | 50 | 500 |
| MN10BCX-A | 051128-59001 | 12 - 10 AWG | 1.20" | 0.038" | 0.38" | 0.142" | 0.218" | 50 | 500 |

Nylon Insulated with Insulation Grip Butt Connectors

Terminal Type: Butt
 Terminal Style: Standard
 Insulation Material: Nylon with Insulation Grip
 Barrel Style: Butted
 RoHS 2011/65/EU: Yes
 Agency Approval: 
 Manufacturing Origin:  With U.S. and Global Content



| Order No. | UPC | Conductor Size | (L) | Thickness | Barrel Length | Barrel I.D. | Max. Insul. Dia. | Terminals per Carton | Terminals per Case |
|-----------|--------------|----------------|-------|-----------|---------------|-------------|------------------|----------------------|--------------------|
| MNG18BCK | 054007-01313 | 22 - 18 AWG | 1.00" | 0.030" | 0.25" | 0.070" | 0.145" | - | 1000 |
| MNG18BCX | 051128-58648 | 22 - 18 AWG | 1.00" | 0.030" | 0.25" | 0.070" | 0.145" | 100 | 500 |
| MNG14BCK | 054007-01818 | 16 - 14 AWG | 1.00" | 0.030" | 0.25" | 0.090" | 0.170" | - | 1000 |
| MNG14BCX | 051128-58679 | 16 - 14 AWG | 1.00" | 0.030" | 0.25" | 0.090" | 0.170" | 100 | 500 |
| MNG10BCK | 054007-15967 | 12 - 10 AWG | 1.15" | 0.040" | 0.25" | 0.135" | 0.250" | - | 500 |
| MNG10BCX | 051128-58692 | 12 - 10 AWG | 1.15" | 0.040" | 0.25" | 0.135" | 0.250" | 50 | 500 |

Nylon Insulated with Insulation Grip Grease Filled Butt Connectors

Terminal Type: Butt
 Terminal Style: Moisture Resistant
 Insulation Material: Nylon with Insulation Grip
 Barrel Style: Butted
 RoHS 2011/65/EU: Yes
 Manufacturing Origin:  With U.S. and Global Content



| Order No. | UPC | Conductor Size | (L) | Thickness | Barrel Length | Barrel I.D. | Max. Insul. Dia. | Terminals per Carton | Terminals per Case |
|-------------|--------------|----------------|-------|-----------|---------------|-------------|------------------|----------------------|--------------------|
| MNG18BCMK-A | 051138-98029 | 22 - 18 AWG | 1.02" | 0.030" | 0.25" | 0.070" | 0.145" | - | 1000 |
| MNG18BCMX-A | 051128-58993 | 22 - 18 AWG | 1.02" | 0.030" | 0.25" | 0.070" | 0.145" | 100 | 500 |
| MNG14BCMK-A | 051138-98035 | 16 - 14 AWG | 1.06" | 0.030" | 0.25" | 0.090" | 0.170" | - | 1000 |
| MNG14BCMX-A | 051128-58994 | 16 - 14 AWG | 1.06" | 0.030" | 0.25" | 0.090" | 0.170" | 100 | 500 |
| MNG10BCMK-A | 051138-98039 | 12 - 10 AWG | 1.23" | 0.040" | 0.25" | 0.135" | 0.250" | - | 500 |
| MNG10BCMX-A | 051128-58995 | 12 - 10 AWG | 1.23" | 0.040" | 0.25" | 0.135" | 0.250" | 50 | 500 |

3M™ Scotchlok™ Butt Connectors

Vinyl Insulated Seamless Butt Connectors

Terminal Type Butt
 Terminal Style Standard
 Insulation Material Vinyl
 Barrel Style Seamless
 RoHS 2011/65/EU Yes

Agency Approval  

Manufacturing Origin 

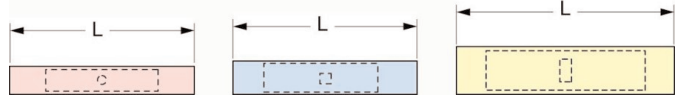

| Order No. | UPC | Conductor Size | (L) | Thickness | Barrel Length | Barrel I.D. | Max. Insul. Dia. | Terminals per Carton | Terminals per Case |
|-----------|--------------|----------------|-------|-----------|---------------|-------------|------------------|----------------------|--------------------|
| MV18BCK | 054007-01312 | 22 - 18 AWG | 1.02" | 0.031" | 0.28" | 0.062" | 0.125" | - | 1000 |
| MV18BCX | 051128-58739 | 22 - 18 AWG | 1.02" | 0.031" | 0.28" | 0.062" | 0.125" | 100 | 500 |
| MV14BCK | 054007-01817 | 16 - 14 AWG | 1.02" | 0.031" | 0.30" | 0.095" | 0.155" | - | 1000 |
| MV14BCX | 051128-58740 | 16 - 14 AWG | 1.02" | 0.031" | 0.30" | 0.095" | 0.155" | 100 | 500 |
| MV10BCK | 054007-02078 | 12 - 10 AWG | 1.20" | 0.038" | 0.38" | 0.142" | 0.218" | - | 500 |
| MV10BCX | 051128-58767 | 12 - 10 AWG | 1.20" | 0.038" | 0.38" | 0.142" | 0.218" | 50 | 500 |

Vinyl Insulated Brazed Seam Butt Connectors

Terminal Type Butt
 Terminal Style Standard
 Insulation Material Vinyl
 Barrel Style Brazed
 RoHS 2011/65/EU Yes

Agency Approval  

Manufacturing Origin 

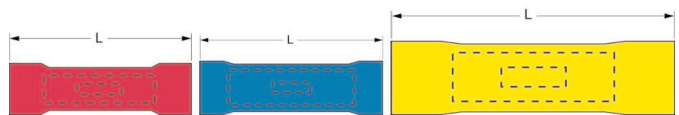

| Order No. | UPC | Conductor Size | (L) | Thickness | Barrel Length | Barrel I.D. | Max. Insul. Dia. | Terminals per Carton | Terminals per Case |
|-----------|--------------|----------------|-------|-----------|---------------|-------------|------------------|----------------------|--------------------|
| MV8BCK | 054007-02144 | 8 AWG | 1.50" | 0.050" | 0.38" | 0.175" | 0.300" | - | 200 |
| MV8BCX | 051128-58773 | 8 AWG | 1.50" | 0.050" | 0.38" | 0.175" | 0.300" | 10 | 100 |
| MV6BCK | 054007-02173 | 6 AWG | 1.71" | 0.050" | 0.47" | 0.250" | 0.400" | - | 200 |
| MV6BCX | 051128-58991 | 6 AWG | 1.71" | 0.050" | 0.47" | 0.250" | 0.400" | 10 | 100 |
| MV4BCK | 054007-02198 | 4 AWG | 2.17" | 0.075" | 0.53" | 0.280" | 0.480" | - | 200 |
| MV4BCX | 051128-59003 | 4 AWG | 2.17" | 0.075" | 0.53" | 0.280" | 0.480" | 10 | 100 |



Vinyl Insulated Butted Seam Butt Connectors

Terminal Type: Butt
 Terminal Style: Standard
 Insulation Material: Vinyl
 Barrel Style: Butted
 RoHS 2011/65/EU: Yes
 Agency Approval: 
 Manufacturing Origin: 



| Order No. | UPC | Conductor Size | (L) | Thickness | Barrel Length | Barrel I.D. | Max. Insul. Dia. | Terminals per Carton | Terminals per Case |
|-----------|--------------|----------------|-------|-----------|---------------|-------------|------------------|----------------------|--------------------|
| MVU18BCK | 054007-01315 | 22 - 18 AWG | 1.00" | 0.030" | 0.25" | 0.070" | 0.145" | - | 1000 |
| MVU18BCX | 051128-58817 | 22 - 18 AWG | 1.00" | 0.030" | 0.25" | 0.070" | 0.145" | 100 | 500 |
| MVU14BCK | 054007-01820 | 16 - 14 AWG | 1.00" | 0.030" | 0.25" | 0.090" | 0.170" | - | 1000 |
| MVU14BCX | 051128-58823 | 16 - 14 AWG | 1.00" | 0.030" | 0.25" | 0.090" | 0.170" | 100 | 500 |
| MVU10BCK | 054007-02081 | 12 - 10 AWG | 1.02" | 0.040" | 0.25" | 0.135" | 0.250" | - | 500 |
| MVU10BCX | 051128-58827 | 12 - 10 AWG | 1.02" | 0.040" | 0.25" | 0.135" | 0.250" | 50 | 500 |

Non-Insulated Seamless Butt Connectors

Terminal Type: Butt
 Terminal Style: Standard
 Insulation Material: Non-Insulated
 Barrel Style: Seamless
 RoHS 2011/65/EU: Yes
 Agency Approval: 
 Manufacturing Origin: 

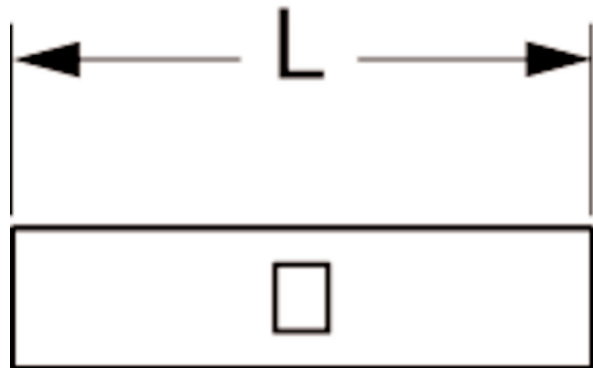

| Order No. | UPC | Conductor Size | (L) | Thickness | Barrel Length | Barrel I.D. | Terminals per Carton | Terminals per Case |
|-----------|--------------|----------------|-------|-----------|---------------|-------------|----------------------|--------------------|
| M18BCK | 054007-01311 | 22 - 18 AWG | 0.63" | 0.031" | 0.28" | 0.062" | - | 1000 |
| M18BCX | 051128-58649 | 22 - 18 AWG | 0.63" | 0.031" | 0.28" | 0.062" | 100 | 500 |
| M14BCK | 054007-01816 | 16 - 14 AWG | 0.66" | 0.031" | 0.30" | 0.095" | - | 1000 |
| M14BCX | 051128-58725 | 16 - 14 AWG | 0.66" | 0.031" | 0.30" | 0.095" | 100 | 500 |
| M10BCK | 054007-02077 | 12 - 10 AWG | 0.81" | 0.038" | 0.38" | 0.142" | - | 500 |
| M10BCX | 051128-58726 | 12 - 10 AWG | 0.81" | 0.038" | 0.38" | 0.142" | 50 | 500 |

Non-Insulated Seamless Compression Butt Connectors

| | |
|----------------------|---|
| Terminal Type | Butt |
| Terminal Style | Compression Connector |
| Insulation Material | Non-Insulated |
| Barrel Style | Seamless |
| RoHS 2011/65/EU | Yes |
| Agency Approval |  |
| Manufacturing Origin |  |

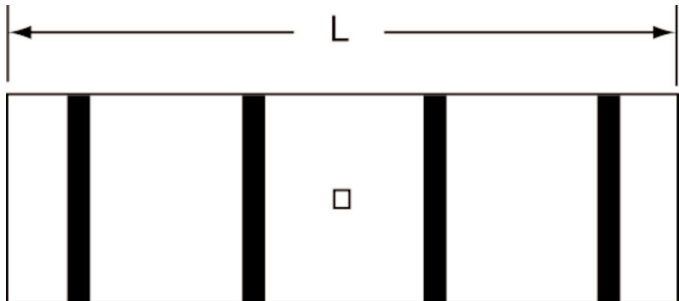

| Order No. | UPC | Conductor Size | (L) | Barrel I.D. | Terminals per Carton | Terminals per Case |
|-----------|--------------|----------------|-------|-------------|----------------------|--------------------|
| MC2BCX | 054007-09205 | 2 AWG | 1.35" | 0.341" | 10 | 100 |
| MC1BCX | 054007-09206 | 1 AWG | 1.35" | 0.365" | 10 | 100 |
| MC1/OBCX | 054007-09207 | 1/0 AWG | 1.55" | 0.412" | 10 | 100 |
| MC2/OBCX | 054007-09208 | 2/0 AWG | 1.80" | 0.466" | 10 | 100 |
| MC3/OBCX | 054007-09209 | 3/0 AWG | 1.90" | 0.516" | 3 | 30 |
| MC4/OBCX | 054007-09210 | 4/0 AWG | 2.00" | 0.564" | 3 | 30 |
| MC250BCX | 054007-09211 | 250 kcmil | 2.00" | 0.595" | 3 | 30 |

Non-Insulated Brazed Seam Butt Connectors

| | |
|----------------------|---|
| Terminal Type | Butt |
| Terminal Style | Standard |
| Insulation Material | Non-Insulated |
| Barrel Style | Brazed |
| RoHS 2011/65/EU | Yes |
| Agency Approval |  |
| Manufacturing Origin |  |



| Order No. | UPC | Conductor Size | (L) | Thickness | Barrel Length | Barrel I.D. | Terminals per Carton | Terminals per Case |
|-----------|--------------|----------------|-------|-----------|---------------|-------------|----------------------|--------------------|
| M8BCK | 054007-02143 | 8 AWG | 0.81" | 0.050" | 0.38" | 0.175" | - | 200 |
| M8BCX | 051128-58727 | 8 AWG | 0.81" | 0.050" | 0.38" | 0.175" | 10 | 100 |
| M6BCK | 054007-02172 | 6 AWG | 1.02" | 0.050" | 0.47" | 0.250" | - | 200 |
| M6BCX | 054007-24225 | 6 AWG | 1.02" | 0.050" | 0.47" | 0.250" | 20 | 200 |
| M4BCK | 054007-02197 | 4 AWG | 1.13" | 0.075" | 0.53" | 0.280" | - | 200 |
| M4BCX | 051128-58728 | 4 AWG | 1.13" | 0.075" | 0.53" | 0.280" | 10 | 100 |

3M™ Scotchlok™ Butt Connectors

Non-Insulated Butted Seam Butt Connectors

| | |
|----------------------|---|
| Terminal Type | Butt |
| Terminal Style | Standard |
| Insulation Material | Non-Insulated |
| Barrel Style | Butted |
| RoHS 2011/65/EU | Yes |
| Agency Approval |  |
| Manufacturing Origin |  |



| Order No. | UPC | Conductor Size | (L) | Thickness | Barrel Length | Barrel I.D. | Terminals per Carton | Terminals per Case |
|-----------|--------------|----------------|-------|-----------|---------------|-------------|----------------------|--------------------|
| MU18BCX | 051128-59006 | 22 - 18 AWG | 0.56" | 0.030" | 0.25" | 0.070" | 100 | 500 |
| MU14BCX | 051128-59007 | 16 - 14 AWG | 0.56" | 0.030" | 0.25" | 0.090" | 100 | 500 |
| MU10BCX | 051128-59008 | 12 - 10 AWG | 0.56" | 0.040" | 0.25" | 0.135" | 50 | 500 |

3M™ Scotchlok™ Female Disconnects

Heat Shrink Nylon Fully Insulated Female Disconnects

| | |
|----------------------|---|
| Terminal Type | Disconnect |
| Terminal Style | Fully Insulated |
| Fastener Orientation | Female |
| Insulation Material | Heat Shrink |
| Barrel Style | Butted |
| RoHS 2011/65/EU | Yes |
| Manufacturing Origin |  |



| Order No. | UPC | Conductor Size | Male Tab Width (W') | (W) | (L) | Diameter (D) | Thickness | Barrel I.D. | Terminals per Carton | Terminals per Case |
|----------------|--------------|----------------|---------------------|-------|-------|--------------|-----------|-------------|----------------------|--------------------|
| MNHU18-250DFIX | 051128-58916 | 22 - 18 AWG | 0.250" | 0.37" | 1.20" | 0.23" | 0.032" | 0.080" | 25 | 125 |
| MNHU18-250DFIK | 054007-06355 | 22 - 18 AWG | 0.250" | 0.37" | 1.20" | 0.23" | 0.032" | 0.080" | - | 250 |
| MNHU14-250DFIX | 051128-58907 | 16 - 14 AWG | 0.250" | 0.37" | 1.20" | 0.23" | 0.032" | 0.080" | 25 | 125 |
| MNHU14-250DFIK | 054007-06339 | 16 - 14 AWG | 0.250" | 0.37" | 1.20" | 0.23" | 0.032" | 0.080" | - | 250 |
| MNHU10-250DFIX | 051128-58895 | 12 - 10 AWG | 0.250" | 0.39" | 1.20" | 0.32" | 0.032" | 0.165" | 25 | 125 |
| MNHU10-250DFIK | 054007-06315 | 12 - 10 AWG | 0.250" | 0.39" | 1.20" | 0.32" | 0.032" | 0.165" | - | 250 |

Nylon Fully Insulated with Insulation Grip Interlock Barrel Female Disconnects

Terminal Type Disconnect
 Terminal Style Fully Insulated
 Fastener Orientation Female
 Insulation Material Nylon with Insulation Grip
 Barrel Style Interlock Barrel
 Barrel Length 0.250"

RoHS 2011/65/EU Yes

Agency Approval



Manufacturing Origin



| Order No. | UPC | Conductor Size | Male Tab Width (W') | (L) | Thickness | Barrel I.D. | Max. Insul. Dia. | Terminals per Carton | Terminals per Case |
|----------------|--------------|----------------|---------------------|-------|-----------|-------------|------------------|----------------------|--------------------|
| MNGI18-250DFIK | 054007-69567 | 22 - 18 AWG | 0.250" | 0.83" | 0.032" | 0.080" | 0.145" | - | 1000 |
| MNGI18-250DFIX | 051128-58924 | 22 - 18 AWG | 0.250" | 0.83" | 0.032" | 0.080" | 0.145" | 100 | 500 |
| MNGI14-250DFIK | 054007-69565 | 16 - 14 AWG | 0.250" | 0.83" | 0.032" | 0.080" | 0.145" | - | 1000 |
| MNGI14-250DFIX | 051128-58922 | 16 - 14 AWG | 0.250" | 0.83" | 0.032" | 0.080" | 0.145" | 100 | 500 |
| MNGI10-250DFIK | 054007-69563 | 12 - 10 AWG | 0.250" | 0.94" | 0.032" | 0.165" | 0.250" | - | 500 |
| MNGI10-250DFIX | 051128-58920 | 12 - 10 AWG | 0.250" | 0.94" | 0.032" | 0.165" | 0.250" | 50 | 500 |

Nylon Fully Insulated Interlock Barrel Female Disconnects

| | |
|----------------------|---|
| Terminal Type | Disconnect |
| Terminal Style | Fully Insulated |
| Fastener Orientation | Female |
| Insulation Material | Nylon |
| Barrel Style | Interlocking Barrel |
| Barrel Length | 0.250" |
| Max. Insul. Dia. | 0.145" |
| RoHS 2011/65/EU | Yes |
| Agency Approval |  |
| Manufacturing Origin |  |



| Order No. | UPC | Conductor Size | Male Tab Width (W') | (L) | Thickness | Barrel I.D. | Term. per Carton | Term. per Case |
|---------------|--------------|----------------|---------------------|-------|-----------|-------------|------------------|----------------|
| MNI18-250DFIX | 051128-58933 | 22 - 18 AWG | 0.250" | 0.91" | 0.032" | 0.076" | 100 | 500 |
| MNI18-250DFIK | 054007-69577 | 22 - 18 AWG | 0.250" | 0.91" | 0.032" | 0.076" | - | 1000 |
| MNI14-250DFIX | 051128-58932 | 16 - 14 AWG | 0.250" | 0.91" | 0.032" | 0.076" | 100 | 500 |
| MNI14-250DFIK | 054007-69575 | 16 - 14 AWG | 0.250" | 0.91" | 0.032" | 0.076" | - | 1000 |
| MNI10-250DFIX | 051128-58930 | 12 - 10 AWG | 0.250" | 0.99" | 0.032" | 0.128" | 50 | 500 |
| MNI10-250DFIK | 054007-69573 | 12 - 10 AWG | 0.250" | 0.99" | 0.032" | 0.128" | - | 500 |

Nylon Fully Insulated with Insulation Grip Female Disconnects

Terminal Type Disconnect
 Terminal Style Fully Insulated
 Fastener Orientation Female
 Insulation Material Nylon with Insulation Grip
 Barrel Style Butted
 RoHS 2011/65/EU Yes

Agency Approval



Manufacturing Origin



| Order No. | UPC | Conductor Size | Mates with Male Tab Width (W') | (L) | (W) | Diameter (D) | Thickness | Barrel I.D. | Max. Insul. Dia. | Term. per Carton | Term. per Case |
|---------------|--------------|----------------|--------------------------------|-------|-------|--------------|-----------|-------------|------------------|------------------|----------------|
| MNG18-187DFIX | 051128-58808 | 22 - 18 AWG | 0.187" | 0.81" | 0.30" | 0.23" | 0.020" | 0.085" | 0.145" | 100 | 500 |
| MNG18-187DFIK | 054007-11816 | 22 - 18 AWG | 0.187" | 0.81" | 0.30" | 0.23" | 0.020" | 0.085" | 0.145" | - | 1000 |
| MNG18-250DFIX | 051128-58809 | 22 - 18 AWG | 0.250" | 0.87" | 0.37" | 0.23" | 0.032" | 0.080" | 0.145" | 100 | 500 |
| MNG18-250DFIK | 054007-02293 | 22 - 18 AWG | 0.250" | 0.87" | 0.37" | 0.23" | 0.032" | 0.080" | 0.145" | - | 1000 |
| MNG14-187DFIX | 051128-58724 | 16 - 14 AWG | 0.187" | 0.81" | 0.30" | 0.23" | 0.020" | 0.085" | 0.145" | 100 | 500 |
| MNG14-187DFIK | 054007-15975 | 16 - 14 AWG | 0.187" | 0.81" | 0.30" | 0.23" | 0.020" | 0.085" | 0.145" | - | 1000 |
| MNG14-250DFIX | 051128-58800 | 16 - 14 AWG | 0.250" | 0.87" | 0.37" | 0.23" | 0.032" | 0.080" | 0.145" | 100 | 500 |
| MNG14-250DFIK | 054007-01841 | 16 - 14 AWG | 0.250" | 0.87" | 0.37" | 0.23" | 0.032" | 0.080" | 0.145" | - | 1000 |

Nylon Fully Insulated Butted Seam Female Disconnects

| | |
|----------------------|---|
| Terminal Type | Disconnect |
| Terminal Style | Fully Insulated |
| Fastener Orientation | Female |
| Insulation Material | Nylon |
| Barrel Style | Butted |
| RoHS 2011/65/EU | Yes |
| Agency Approval |   |
| Manufacturing Origin |  |



| Order No. | UPC | Conductor Size | Mates with Male Tab Width (W') | (W) | (L) | Diameter (D) | Thickness | Barrel I.D. | Max. Insul. Dia. | Terminals per Carton | Terminals per Case |
|---------------|--------------|----------------|--------------------------------|-------|-------|--------------|-----------|-------------|------------------|----------------------|--------------------|
| MNU18-250DFIK | 054007-02290 | 22 - 18 AWG | 0.250" | 0.37" | 0.87" | 0.23" | 0.032" | 0.080" | 0.145" | - | 1000 |
| MNU18-250DFIX | 051128-58776 | 22 - 18 AWG | 0.250" | 0.37" | 0.87" | 0.23" | 0.032" | 0.080" | 0.145" | 100 | 500 |
| MNU18-187DFIK | 054007-02370 | 22 - 18 AWG | 0.187" | 0.30" | 0.81" | 0.23" | 0.020" | 0.085" | 0.145" | - | 1000 |
| MNU18-187DFIX | 051128-58783 | 22 - 18 AWG | 0.187" | 0.30" | 0.81" | 0.23" | 0.020" | 0.085" | 0.145" | 100 | 500 |
| MNU14-250DFIK | 054007-02291 | 16 - 14 AWG | 0.250" | 0.37" | 0.87" | 0.23" | 0.032" | 0.080" | 0.145" | - | 1000 |
| MNU14-250DFIX | 051128-58777 | 16 - 14 AWG | 0.250" | 0.37" | 0.87" | 0.23" | 0.032" | 0.080" | 0.145" | 100 | 500 |
| MNU14-187DFIK | 054007-02384 | 16 - 14 AWG | 0.187" | 0.30" | 0.81" | 0.23" | 0.020" | 0.085" | 0.145" | - | 1000 |
| MNU14-187DFIX | 051128-58787 | 16 - 14 AWG | 0.187" | 0.30" | 0.81" | 0.23" | 0.020" | 0.085" | 0.145" | 100 | 500 |
| MNU10-250DFIX | 051128-58812 | 12 - 10 AWG | 0.250" | - | - | 0.99" | 0.032" | 0.128" | - | 50 | 500 |

Nylon Insulated with Insulation Grip Interlock Barrel Female Disconnects

Terminal Type Disconnect
 Terminal Style Standard
 Fastener Orientation Female
 Insulation Material Nylon with Insulation Grip
 Barrel Style Interlocking Barrel
 RoHS 2011/65/EU Yes
 Agency Approval 

Manufacturing Origin 
 With U.S. and Global Content



| Order No. | UPC | Conductor Size | Mates with Male Tab Width (W') | (L) | Thickness | Barrel I.D. | Max. Insul. Dia. | Terminals per Carton | Terminals per Case |
|---------------|--------------|----------------|--------------------------------|-------|-----------|-------------|------------------|----------------------|--------------------|
| MNGI18-250DFX | 051128-58929 | 22 - 18 AWG | 0.250" | 0.83" | 0.032" | 0.076" | 0.145" | 100 | 500 |
| MNGI18-250DFK | 054007-69572 | 22 - 18 AWG | 0.250" | 0.83" | 0.032" | 0.076" | 0.145" | - | 1000 |
| MNGI14-250DFX | 051128-58927 | 16 - 14 AWG | 0.250" | 0.83" | 0.032" | 0.076" | 0.145" | 100 | 500 |
| MNGI14-250DFK | 054007-69570 | 16 - 14 AWG | 0.250" | 0.83" | 0.032" | 0.076" | 0.145" | - | 1000 |
| MNGI10-250DFX | 051128-58925 | 12 - 10 AWG | 0.250" | 0.94" | 0.032" | 0.128" | 0.250" | 50 | 500 |
| MNGI10-250DFK | 054007-69568 | 12 - 10 AWG | 0.250" | 0.94" | 0.032" | 0.128" | 0.250" | - | 500 |

Nylon Insulated with Insulation Grip Bullet Style Female Disconnects

Terminal Type Disconnect
 Terminal Style Bullet Snap Plug
 Fastener Orientation Female
 Insulation Material Nylon with Insulation Grip
 Barrel Style Butted
 RoHS 2011/65/EU Yes
 Manufacturing Origin Taiwan



| Order No. | UPC | Conductor Size | Mating Snap Diameter (S) | (L) | Barrel I.D. | Max. Insul. Dia. | Terminals per Carton | Terminals per Case |
|-----------------|--------------|----------------|--------------------------|-------|-------------|------------------|----------------------|--------------------|
| MNG18-156DFIK-A | 051138-98078 | 22 - 18 AWG | 0.156" | 0.99" | 0.145" | 0.150" | - | 1000 |
| MNG18-180DFIK-A | 051138-98084 | 22 - 18 AWG | 0.180" | 1.00" | 0.095" | 0.150" | - | 1000 |
| MNG14-156DFIK-A | 051138-98117 | 16 - 14 AWG | 0.156" | 0.99" | 0.115" | 0.190" | - | 1000 |
| MNG14-156DFIX-A | 051128-58870 | 16 - 14 AWG | 0.156" | 0.99" | 0.115" | 0.190" | 100 | 500 |
| MNG14-180DFIK-A | 051138-98127 | 16 - 14 AWG | 0.180" | 1.00" | 0.115" | 0.190" | - | 1000 |
| MNG14-180DFIX-A | 051128-58869 | 16 - 14 AWG | 0.180" | 1.00" | 0.115" | 0.190" | 100 | 500 |

3M™ Scotchlok™ Female Disconnects

Nylon Insulated with Insulation Grip Female Disconnects

Terminal Type Disconnect
Terminal Style Standard
Fastener Orientation Female
Insulation Material Nylon with Insulation Grip
Barrel Style Butted
RoHS 2011/65/EU Yes



Agency Approval Except for 110DF & 375DF Female Disconnects



Manufacturing Origin Product numbers ending with "-A" are made in Taiwan.



| Order No. | UPC | Conductor Size | Mates with Male Tab Width (W') | Thickness | (L) | Barrel I.D. | Max. Insul. Dia. | Terminals per Carton | Terminals per Case |
|----------------|--------------|----------------|--------------------------------|-----------|-------|-------------|------------------|----------------------|--------------------|
| MNG18-110DFK-A | 051128-57445 | 22 - 18 AWG | 0.110" | 0.020" | 0.77" | 0.080" | 0.160" | - | 1000 |
| MNG18-187DFK | 054007-02405 | 22 - 18 AWG | 0.187" | 0.020" | 0.77" | 0.085" | 0.145" | - | 1000 |
| MNG18-250DFK | 054007-02369 | 22 - 18 AWG | 0.250" | 0.032" | 0.86" | 0.080" | 0.145" | - | 1000 |
| MNG18-250DFX | 051128-58789 | 22 - 18 AWG | 0.250" | 0.032" | 0.86" | 0.080" | 0.145" | 100 | 500 |
| MNG14-110DFK-A | 051128-57437 | 16 - 14 AWG | 0.110" | 0.020" | 0.77" | - | 0.200" | - | 1000 |
| MNG14-187DFK | 054007-01773 | 16 - 14 AWG | 0.187" | 0.020" | 0.77" | 0.085" | 0.145" | - | 1000 |
| MNG14-187DFX | 051128-58672 | 16 - 14 AWG | 0.187" | 0.020" | 0.77" | 0.085" | 0.145" | 100 | 500 |
| MNG14-250DFK | 054007-01774 | 16 - 14 AWG | 0.250" | 0.032" | 0.86" | 0.080" | 0.145" | - | 1000 |
| MNG14-250DFX | 051128-58673 | 16 - 14 AWG | 0.250" | 0.032" | 0.86" | 0.080" | 0.145" | 100 | 500 |
| MNG10-375DFK | 054007-02053 | 12 - 10 AWG | 0.375" | 0.050" | 1.23" | 0.175" | 0.250" | - | 500 |

Vinyl Insulated Interlock Barrel Female Disconnects

| | |
|----------------------|---|
| Terminal Type | Disconnect |
| Terminal Style | Standard |
| Fastener Orientation | Female |
| Insulation Material | Vinyl |
| Barrel Style | Interlocking Barrel |
| RoHS 2011/65/EU | Yes |
| Agency Approval |  |
| Manufacturing Origin |  |



| Order No. | UPC | Conductor Size | Mates with Male Tab Width (W') | Thickness | (L) | Barrel I.D. | Max. Insul. Dia. | Terminals per Carton | Terminals per Case |
|--------------|--------------|----------------|--------------------------------|-----------|-------|-------------|------------------|----------------------|--------------------|
| MVI18-250DFX | 051128-58935 | 22 - 18 AWG | 0.250" | 0.032" | 0.83" | 0.076" | 0.145" | 100 | 500 |
| MVI18-250DFK | 054007-69582 | 22 - 18 AWG | 0.250" | 0.032" | 0.83" | 0.076" | 0.145" | - | 1000 |
| MVI14-250DFX | 051128-58938 | 16 - 14 AWG | 0.250" | 0.032" | 0.83" | 0.076" | 0.145" | 100 | 500 |
| MVI14-250DFK | 054007-69580 | 16 - 14 AWG | 0.250" | 0.032" | 0.83" | 0.076" | 0.145" | - | 1000 |
| MVI10-250DFX | 051128-58936 | 12 - 10 AWG | 0.250" | 0.032" | 0.95" | 0.128" | 0.250" | 50 | 500 |
| MVI10-250DFK | 054007-69578 | 12 - 10 AWG | 0.250" | 0.032" | 0.95" | 0.128" | 0.250" | - | 500 |

Vinyl Insulated with Insulation Grip Female Disconnects

| | |
|----------------------|---|
| Terminal Type | Disconnect |
| Terminal Style | Standard |
| Fastener Orientation | Female |
| Insulation Material | Vinyl with Insulation Grip |
| Barrel Style | Butted |
| RoHS 2011/65/EU | Yes |
| Manufacturing Origin |  |



| Order No. | UPC | Conductor Size | Mates with Male Tab Width (W') | Thickness | (L) | Barrel I.D. | Max. Insul. Dia. | Terminals per Carton | Terminals per Case |
|-----------------|--------------|----------------|--------------------------------|-----------|-------|-------------|------------------|----------------------|--------------------|
| MVG24-110/32DFX | 051128-58998 | 26 - 24 AWG | 0.110" | 0.032" | 0.63" | 0.055" | 0.093" | 100 | 500 |
| MVG24-110DFK | 054007-95151 | 26 - 24 AWG | 0.110" | 0.020" | 0.63" | 0.055" | 0.093" | - | 1000 |

Vinyl Insulated Butted Seam Female Disconnects

| | |
|-----------------------------|---|
| Terminal Type | Disconnect |
| Terminal Style | Standard |
| Fastener Orientation | Female |
| Insulation Material | Vinyl |
| Barrel Style | Butted |
| RoHS 2011/65/EU | Yes |
| Agency Approval |  Except for 110DF Female Disconnects |
| Manufacturing Origin |  Product numbers ending with "-A" are made in Taiwan. |



| Order No. | UPC | Conductor Size | Mates with Male Tab Width (W') | Thickness | (L) | Barrel I.D. | Max. Insul. Dia. | Terminals per Carton | Terminals per Case |
|----------------|--------------|----------------|--------------------------------|-----------|-------|-------------|------------------|----------------------|--------------------|
| MVU18-187DFX | 051128-59013 | 22 - 18 AWG | 0.187" | 0.020" | 0.78" | 0.085" | 0.145" | 100 | 500 |
| MVU18-187DFK | 054007-02368 | 22 - 18 AWG | 0.187" | 0.020" | 0.78" | 0.085" | 0.145" | - | 1000 |
| MVU18-250DFX | 051128-58790 | 22 - 18 AWG | 0.250" | 0.032" | 0.87" | 0.080" | 0.145" | 100 | 500 |
| MVU18-250DFK | 054007-01301 | 22 - 18 AWG | 0.250" | 0.032" | 0.87" | 0.080" | 0.145" | - | 1000 |
| MVU14-110DFK-A | 051128-57438 | 16 - 14 AWG | 0.110" | 0.020" | 0.73" | - | 0.180" | - | 1000 |
| MVU14-187DFX | 051128-58670 | 16 - 14 AWG | 0.187" | 0.020" | 0.78" | 0.085" | 0.145" | 100 | 500 |
| MVU14-187DFK | 054007-01776 | 16 - 14 AWG | 0.187" | 0.020" | 0.78" | 0.085" | 0.145" | - | 1000 |
| MVU14-250DFX | 051128-58671 | 16 - 14 AWG | 0.250" | 0.032" | 0.87" | 0.080" | 0.145" | 100 | 500 |
| MVU14-250DFK | 054007-01777 | 16 - 14 AWG | 0.250" | 0.032" | 0.87" | 0.080" | 0.145" | - | 1000 |
| MVU10-375DFK | 054007-02055 | 12 - 10 AWG | 0.375" | 0.050" | 1.23" | 0.175" | 0.250" | - | 500 |

3M™ Scotchlok™ Female Disconnects

Non-Insulated Interlock Barrel Female Disconnects

Terminal Type Disconnect
 Terminal Style Standard
 Fastener Orientation Female
 Insulation Material Non-Insulated
 Barrel Style Interlocking Barrel
 RoHS 2011/65/EU Yes



| Order No. | UPC | Conductor Size | Mates with Male Tab Width (W') | (L) | Thickness | Barrel I.D. | Terminals per Carton | Terminals per Case |
|-------------|--------------|----------------|--------------------------------|-------|-----------|-------------|----------------------|--------------------|
| MI18-250DFK | 054007-69561 | 22 - 18 AWG | 0.250" | 0.63" | 0.032" | 0.076" | - | 1000 |
| MI10-250DFX | 051128-58860 | 12 - 10 AWG | 0.250" | 0.64" | 0.032" | 0.128" | 50 | 500 |
| MI10-250DFK | 054007-69557 | 12 - 10 AWG | 0.250" | 0.64" | 0.032" | 0.128" | - | 500 |

Non-Insulated Butted Seam Female Disconnects

Terminal Type Disconnect
 Terminal Style Standard
 Fastener Orientation Female
 Insulation Material Non-Insulated
 Barrel Style Butted
 RoHS 2011/65/EU Yes

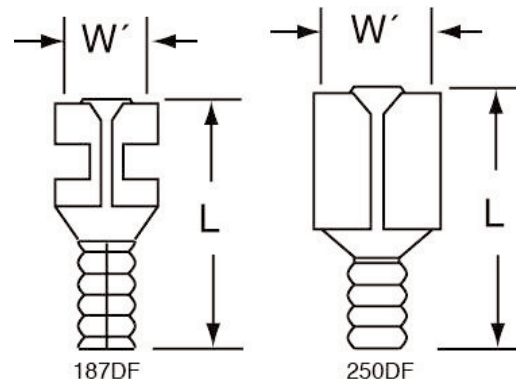

| Order No. | UPC | Conductor Size | Mates with Male Tab Width (W') | (L) | Thickness | Barrel I.D. | Terminals per Carton | Terminals per Case |
|------------------|--------------|----------------|--------------------------------|-------|-----------|-------------|----------------------|--------------------|
| MU20-110/32DFK-A | 051128-57616 | 26 - 20 AWG | 0.110" | 0.48" | 0.032" | 0.040" | - | 1000 |
| MU18-187DFX | 051128-59014 | 22 - 18 AWG | 0.187" | 0.58" | 0.020" | 0.085" | 100 | 500 |
| MU18-187DFK | 054007-02366 | 22 - 18 AWG | 0.187" | 0.58" | 0.020" | 0.085" | - | 1000 |
| MU18-250DFX | 051128-58788 | 22 - 18 AWG | 0.250" | 0.66" | 0.032" | 0.080" | 100 | 500 |
| MU18-250DFK | 054007-01300 | 22 - 18 AWG | 0.250" | 0.66" | 0.032" | 0.080" | - | 1000 |
| MU14-110DFX | 051128-58706 | 16 - 14 AWG | 0.110" | 0.54" | 0.020" | 0.115" | 100 | 500 |
| MU14-110DFK | 054007-13995 | 16 - 14 AWG | 0.110" | 0.54" | 0.020" | 0.115" | - | 1000 |
| MU14-187DFK | 054007-01767 | 16 - 14 AWG | 0.187" | 0.58" | 0.020" | 0.085" | - | 1000 |

Non-Insulated Butted Seam Female Disconnects (continued)

| Order No. | UPC | Conductor Size | Mates with Male Tab Width (W') | (L) | Thickness | Barrel I.D. | Terminals per Carton | Terminals per Case |
|-------------|--------------|----------------|--------------------------------|-------|-----------|-------------|----------------------|--------------------|
| MU14-187DFX | 051128-58707 | 16 - 14 AWG | 0.187" | 0.58" | 0.020" | 0.085" | 100 | 500 |
| MU14-250DFX | 051128-58708 | 16 - 14 AWG | 0.250" | 0.66" | 0.032" | 0.080" | 100 | 500 |
| MU14-250DFK | 054007-01768 | 16 - 14 AWG | 0.250" | 0.66" | 0.032" | 0.080" | - | 1000 |

Non-Insulated Butted Seam Flag Female Disconnects

Terminal Type Disconnect
Terminal Style Flag
Fastener Orientation Female
Insulation Material Non-Insulated
Barrel Style Butted
RoHS 2011/65/EU Yes

Agency Approval

 Except for 187DF Flag Female Disconnects

Manufacturing Origin



| Order No. | UPC | Conductor Size | Mates with Male Tab Width (W') | (L) | Thickness | Barrel I.D. | Terminals per Carton | Terminals per Case |
|------------------|--------------|----------------|--------------------------------|-------|-----------|-------------|----------------------|--------------------|
| MU18-187DF/FLAGX | 051128-59092 | 22 - 18 AWG | 0.187" | 0.46" | 0.020" | 0.075" | 100 | 500 |
| MU18-187DF/FLAGK | 054007-01302 | 22 - 18 AWG | 0.187" | 0.46" | 0.020" | 0.075" | - | 1000 |
| MU18-250DF/FLAGX | 051128-59091 | 22 - 18 AWG | 0.250" | 0.50" | 0.032" | 0.075" | 100 | 500 |
| MU18-250DF/FLAGK | 054007-01303 | 22 - 18 AWG | 0.250" | 0.66" | 0.032" | 0.080" | - | 1000 |
| MU14-187DF/FLAGX | 051128-59089 | 16 - 14 AWG | 0.187" | 0.47" | 0.020" | 0.095" | 100 | 500 |
| MU14-187DF/FLAGK | 054007-01778 | 16 - 14 AWG | 0.187" | 0.47" | 0.020" | 0.095" | - | 1000 |
| MU14-250DF/FLAGX | 051128-59090 | 16 - 14 AWG | 0.250" | 0.51" | 0.032" | 0.095" | 100 | 500 |
| MU14-250DF/FLAGK | 054007-01779 | 16 - 14 AWG | 0.250" | 0.51" | 0.032" | 0.095" | - | 1000 |

Heat Shrink Nylon Fully Insulated Butted Seam Male Disconnects

Terminal Type Disconnect
 Terminal Style Fully Insulated
 Fastener Orientation Male
 Insulation Material Heat Shrink
 Barrel Style Butted
 RoHS 2011/65/EU Yes

Manufacturing Origin



| Order No. | UPC | Conductor Size | Male Tab Width (W') | (L) | (W) | Diameter (D) | Thickness | Barrel I.D. | Terminals per Carton | Terminals per Case |
|----------------|--------------|----------------|---------------------|-------|-------|--------------|-----------|-------------|----------------------|--------------------|
| MNHU18-250DMIX | 051128-58917 | 22 - 18 AWG | 0.250" | 1.20" | 0.44" | 0.30" | 0.032" | 0.065" | 25 | 125 |
| MNHU18-250DMIK | 054007-06357 | 22 - 18 AWG | 0.250" | 1.20" | 0.44" | 0.30" | 0.032" | 0.065" | - | 250 |
| MNHU14-250DMIX | 051128-58908 | 16 - 14 AWG | 0.250" | 1.20" | 0.44" | 0.30" | 0.032" | 0.085" | 25 | 125 |
| MNHU14-250DMIK | 054007-06341 | 16 - 14 AWG | 0.250" | 1.20" | 0.44" | 0.30" | 0.032" | 0.085" | - | 250 |
| MNHU10-250DMIX | 051128-58896 | 12 - 10 AWG | 0.250" | 1.20" | 0.47" | 0.39" | 0.032" | 0.150" | 25 | 125 |
| MNHU10-250DMIK | 054007-06317 | 12 - 10 AWG | 0.250" | 1.20" | 0.47" | 0.39" | 0.032" | 0.150" | - | 250 |

Nylon Fully Insulated with Insulation Grip Male Disconnects

Terminal Type Disconnect
 Terminal Style Fully Insulated
 Fastener Orientation Male
 Insulation Material Nylon with Insulation Grip
 Barrel Style Butted
 RoHS 2011/65/EU Yes

Agency Approval



Manufacturing Origin



| Order No. | UPC | Conductor Size | Male Tab Width (W') | (L) | (W) | Diameter (D) | Thickness | Barrel I.D. | Terminals per Carton | Terminals per Case |
|---------------|--------------|----------------|---------------------|-------|-------|--------------|-----------|-------------|----------------------|--------------------|
| MNG18-187DMIX | 051128-58807 | 22 - 18 AWG | 0.187" | 0.87" | 0.37" | 0.30" | 0.020" | 0.145" | 100 | 500 |
| MNG18-187DMIK | 054007-11794 | 22 - 18 AWG | 0.187" | 0.87" | 0.37" | 0.30" | 0.020" | 0.145" | - | 1000 |
| MNG18-250DMIX | 051128-58803 | 22 - 18 AWG | 0.250" | 0.95" | 0.44" | 0.30" | 0.032" | 0.145" | 50 | 500 |
| MNG18-250DMIK | 054007-02302 | 22 - 18 AWG | 0.250" | 0.95" | 0.44" | 0.30" | 0.032" | 0.145" | - | 1000 |
| MNG14-187DMIX | 051128-58799 | 16 - 14 AWG | 0.187" | 0.87" | 0.37" | 0.30" | 0.020" | 0.145" | 100 | 500 |
| MNG14-187DMIK | 054007-02386 | 16 - 14 AWG | 0.187" | 0.87" | 0.37" | 0.30" | 0.020" | 0.145" | - | 1000 |
| MNG14-250DMIX | 051128-58774 | 16 - 14 AWG | 0.250" | 0.95" | 0.44" | 0.30" | 0.032" | 0.170" | 50 | 500 |

Nylon Fully Insulated with Insulation Grip Male Disconnects (continued)

| Order No. | UPC | Conductor Size | Male Tab Width (W') | (L) | (W) | Diameter (D) | Thickness | Barrel I.D. | Terminals per Carton | Terminals per Case |
|---------------|--------------|----------------|---------------------|-------|-------|--------------|-----------|-------------|----------------------|--------------------|
| MNG14-250DMIK | 054007-02249 | 16 - 14 AWG | 0.250" | 0.95" | 0.44" | 0.30" | 0.032" | 0.170" | - | 1000 |
| MNG10-250DMIX | 051128-58793 | 12 - 10 AWG | 0.250" | 1.05" | 0.47" | 0.39" | 0.032" | 0.250" | 50 | 500 |
| MNG10-250DMIK | 054007-02303 | 12 - 10 AWG | 0.250" | 1.05" | 0.47" | 0.39" | 0.032" | 0.250" | - | 500 |

Nylon Fully Insulated Butted Seam Male Disconnects

Terminal Type Disconnect
Terminal Style Fully Insulated
Fastener Orientation Male
Insulation Material Nylon
Barrel Style Butted
RoHS 2011/65/EU Yes
Agency Approval 
Manufacturing Origin 

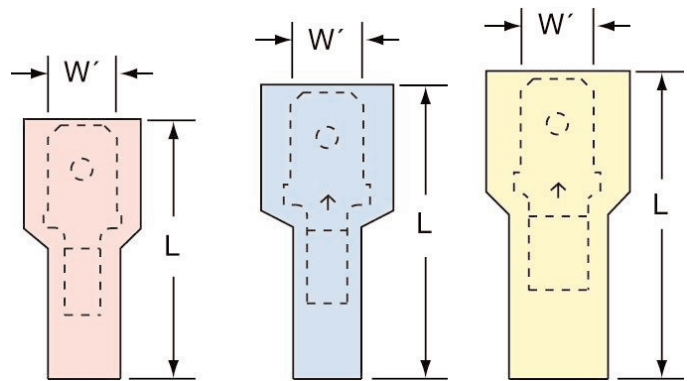

| Order No. | UPC | Conductor Size | Male Tab Width (W') | (L) | (W) | Diameter (D) | Thickness | Barrel I.D. | Max. Insul. Dia. | Terminals per Carton | Terminals per Case |
|---------------|--------------|----------------|---------------------|-------|-------|--------------|-----------|-------------|------------------|----------------------|--------------------|
| MNU18-187DMIX | 051128-58784 | 22 - 18 AWG | 0.187" | 0.87" | 0.37" | 0.30" | 0.020" | 0.080" | 0.145" | 100 | 500 |
| MNU18-187DMIK | 054007-02379 | 22 - 18 AWG | 0.187" | 0.87" | 0.37" | 0.30" | 0.020" | 0.080" | 0.145" | - | 1000 |
| MNU18-250DMIX | 051128-58778 | 22 - 18 AWG | 0.250" | 0.95" | 0.44" | 0.30" | 0.032" | 0.065" | 0.145" | 50 | 500 |
| MNU18-250DMIK | 054007-02299 | 22 - 18 AWG | 0.250" | 0.95" | 0.44" | 0.30" | 0.032" | 0.065" | 0.145" | - | 1000 |
| MNU14-187DMIX | 051128-58786 | 16 - 14 AWG | 0.187" | 0.87" | 0.37" | 0.30" | 0.020" | 0.080" | 0.145" | 100 | 500 |
| MNU14-187DMIK | 054007-02385 | 16 - 14 AWG | 0.187" | 0.87" | 0.37" | 0.30" | 0.020" | 0.080" | 0.145" | - | 1000 |
| MNU14-250DMIK | 054007-02300 | 16 - 14 AWG | 0.250" | 0.95" | 0.44" | 0.30" | 0.032" | 0.085" | 0.170" | - | 1000 |
| MNU14-250DMIX | 051128-58779 | 16 - 14 AWG | 0.250" | 0.95" | 0.44" | 0.30" | 0.032" | 0.085" | 0.170" | 50 | 500 |
| MNU10-250DMIX | 051128-58780 | 12 - 10 AWG | 0.250" | 1.05" | 0.47" | 0.39" | 0.032" | 0.150" | 0.250" | 50 | 500 |
| MNU10-250DMIK | 054007-02301 | 12 - 10 AWG | 0.250" | 1.05" | 0.47" | 0.39" | 0.032" | 0.150" | 0.250" | - | 500 |

Nylon Insulated with Insulation Grip Male Disconnects

Terminal Type Disconnect
 Terminal Style Standard
 Fastener Orientation Male
 Insulation Material Nylon
 Barrel Style Insulation Grip
 RoHS 2011/65/EU Yes
 Agency Approval 

Manufacturing Origin 
 With U.S. and Global Content



| Order No. | UPC | Conductor Size | Male Tab Width (W') | (L) | Thickness | Barrel I.D. | Max. Insul. Dia. | Terminals per Carton | Terminals per Case |
|--------------|--------------|----------------|---------------------|-------|-----------|-------------|------------------|----------------------|--------------------|
| MNG18-187DMK | 054007-02377 | 22 - 18 AWG | 0.187" | 0.84" | 0.020" | 0.080" | 0.145" | - | 1000 |
| MNG18-250DMX | 051128-58785 | 22 - 18 AWG | 0.250" | 0.92" | 0.032" | 0.065" | 0.145" | 100 | 500 |
| MNG18-250DMK | 054007-02378 | 22 - 18 AWG | 0.250" | 0.92" | 0.032" | 0.065" | 0.145" | - | 1000 |
| MNG14-187DMX | 051128-58677 | 16 - 14 AWG | 0.187" | 0.84" | 0.020" | 0.080" | 0.145" | 100 | 500 |
| MNG14-187DMK | 054007-01787 | 16 - 14 AWG | 0.187" | 0.84" | 0.020" | 0.080" | 0.145" | - | 1000 |
| MNG14-250DMX | 051128-58678 | 16 - 14 AWG | 0.250" | 0.94" | 0.032" | 0.085" | 0.170" | 100 | 500 |
| MNG14-250DMK | 054007-01788 | 16 - 14 AWG | 0.250" | 0.94" | 0.032" | 0.085" | 0.170" | - | 1000 |
| MNG10-250DMX | 051128-58721 | 12 - 10 AWG | 0.250" | 1.05" | 0.032" | 0.150" | 0.250" | 50 | 500 |
| MNG10-250DMK | 054007-02058 | 12 - 10 AWG | 0.250" | 1.05" | 0.032" | 0.150" | 0.250" | - | 500 |

Nylon Insulated with Insulation Grip Bullet Style Male Disconnects

Terminal Type Disconnect
 Terminal Style Bullet Snap Plug
 Fastener Orientation Male
 Insulation Material Nylon
 Barrel Style Insulation Grip
 RoHS 2011/65/EU Yes
 Manufacturing Origin Taiwan



| Order No. | UPC | Conductor Size | Mating Snap Diameter (S) | (L) | Max. Insul. Dia. | Terminals per Carton | Terminals per Case |
|----------------|--------------|----------------|--------------------------|-------|------------------|----------------------|--------------------|
| MNG18-156DMK-A | 051138-98088 | 22 - 18 AWG | 0.156" | 0.87" | 0.150" | - | 1000 |
| MNG18-180DMK-A | 051138-98100 | 22 - 18 AWG | 0.180" | 0.87" | 0.150" | - | 1000 |
| MNG14-156DMK-A | 051138-98137 | 16 - 14 AWG | 0.156" | 0.87" | 0.190" | - | 1000 |
| MNG14-156DMX-A | 051128-58868 | 16 - 14 AWG | 0.156" | 0.87" | 0.190" | 100 | 500 |

Vinyl Insulated Butted Seam Male Disconnects

Terminal Type Disconnect
Terminal Style Standard
Fastener Orientation Male
Insulation Material Vinyl
Barrel Style Butted
RoHS 2011/65/EU Yes
Agency Approval 
Manufacturing Origin 



| Order No. | UPC | Conductor Size | Male Tab Width (W') | (L) | Thickness | Barrel I.D. | Max. Insul. Dia. | Terminals per Carton | Terminals per Case |
|--------------|--------------|----------------|---------------------|-------|-----------|-------------|------------------|----------------------|--------------------|
| MVU18-187DMX | 051128-59012 | 22 - 18 AWG | 0.187" | 0.85" | 0.020" | 0.080" | 0.145" | 100 | 500 |
| MVU18-187DMK | 054007-02375 | 22 - 18 AWG | 0.187" | 0.85" | 0.020" | 0.080" | 0.145" | - | 1000 |
| MVU18-250DMX | 051128-58782 | 22 - 18 AWG | 0.250" | 0.93" | 0.032" | 0.065" | 0.145" | 100 | 500 |
| MVU18-250DMK | 054007-02376 | 22 - 18 AWG | 0.250" | 0.93" | 0.032" | 0.065" | 0.145" | - | 1000 |
| MVU14-187DMX | 051128-58674 | 16 - 14 AWG | 0.187" | 0.85" | 0.020" | 0.080" | 0.145" | 100 | 500 |
| MVU14-187DMK | 054007-01789 | 16 - 14 AWG | 0.187" | 0.85" | 0.020" | 0.080" | 0.145" | - | 1000 |
| MVU14-250DMX | 051128-58676 | 16 - 14 AWG | 0.250" | 0.93" | 0.032" | 0.085" | 0.170" | 100 | 500 |
| MVU14-250DMK | 054007-01790 | 16 - 14 AWG | 0.250" | 0.93" | 0.032" | 0.085" | 0.170" | - | 1000 |
| MVU10-250DMX | 051128-58675 | 12 - 10 AWG | 0.250" | 1.05" | 0.032" | 0.150" | 0.250" | 50 | 500 |
| MVU10-250DMK | 054007-02059 | 12 - 10 AWG | 0.250" | 1.05" | 0.032" | 0.150" | 0.250" | - | 500 |

Vinyl Insulated Butted Seam Bullet Style Male Disconnects

Terminal Type Disconnect
Terminal Style Bullet Snap Plug
Fastener Orientation Male
Insulation Material Vinyl
Barrel Style Butted
RoHS 2011/65/EU Yes
Manufacturing Origin Taiwan



| Order No. | UPC | Conductor Size | Mating Snap Diameter (S) | (L) | Max. Insul. Dia. | Terminals per Carton | Terminals per Case |
|----------------|--------------|----------------|--------------------------|-------|------------------|----------------------|--------------------|
| MVU18-156DMK-A | 051138-98094 | 22 - 18 AWG | 0.156" | 0.83" | 0.150" | - | 1000 |
| MVU18-180DMK-A | 051138-98104 | 22 - 18 AWG | 0.180" | 0.83" | 0.150" | - | 1000 |
| MVU14-156DMK-A | 051138-98149 | 16 - 14 AWG | 0.156" | 0.83" | 0.170" | - | 1000 |
| MVU14-156DMX-A | 051128-58867 | 16 - 14 AWG | 0.156" | 0.83" | 0.170" | 100 | 500 |
| MVU14-180DMK-A | 051138-98162 | 16 - 14 AWG | 0.180" | 0.83" | 0.170" | - | 1000 |
| MVU14-180DMX-A | 051128-58866 | 16 - 14 AWG | 0.180" | 0.83" | 0.170" | 100 | 500 |

Non-Insulated Butted Seam Male Disconnects

| | |
|----------------------|---|
| Terminal Type | Disconnect |
| Terminal Style | Standard |
| Fastener Orientation | Male |
| Insulation Material | Non-Insulated |
| Barrel Style | Butted |
| RoHS 2011/65/EU | Yes |
| Agency Approval |  |
| Manufacturing Origin |  |



| Order No. | UPC | Conductor Size | Male Tab Width (W') | (L) | Thickness | Barrel I.D. | Terminals per Carton | Terminals per Case |
|-------------|--------------|----------------|---------------------|-------|-----------|-------------|----------------------|--------------------|
| MU18-187DMX | 051128-59009 | 22 - 18 AWG | 0.187" | 0.64" | 0.020" | 0.080" | 100 | 500 |
| MU18-187DMK | 054007-02372 | 22 - 18 AWG | 0.187" | 0.64" | 0.020" | 0.080" | - | 1000 |
| MU18-250DMX | 051128-59010 | 22 - 18 AWG | 0.250" | 0.73" | 0.032" | 0.065" | 100 | 500 |
| MU18-250DMK | 054007-02364 | 22 - 18 AWG | 0.250" | 0.73" | 0.032" | 0.065" | - | 1000 |
| MU14-187DMX | 051128-59011 | 16 - 14 AWG | 0.187" | 0.64" | 0.020" | 0.080" | 100 | 500 |
| MU14-187DMK | 054007-01783 | 16 - 14 AWG | 0.187" | 0.64" | 0.020" | 0.080" | - | 1000 |
| MU14-250DMX | 051128-58709 | 16 - 14 AWG | 0.250" | 0.73" | 0.032" | 0.085" | 100 | 500 |
| MU14-250DMK | 054007-01784 | 16 - 14 AWG | 0.250" | 0.73" | 0.032" | 0.085" | - | 1000 |
| MU10-250DMX | 051128-58691 | 12 - 10 AWG | 0.250" | 0.75" | 0.032" | 0.150" | 50 | 500 |
| MU10-250DMK | 054007-02056 | 12 - 10 AWG | 0.250" | 0.75" | 0.032" | 0.150" | - | 500 |

Nylon Insulated with Insulation Grip Piggy-Back Disconnects

| | |
|----------------------|-----------------|
| Terminal Type | Disconnect |
| Terminal Style | Piggy-Back |
| Fastener Orientation | Male-Female |
| Insulation Material | Nylon |
| Barrel Style | Insulation Grip |
| RoHS 2011/65/EU | Yes |
| Manufacturing Origin | Taiwan |



| Order No. | UPC | Conductor Size | Mates with Male Tab Width (W') | (L) | Thickness | Max. Insul. Dia. | Term. per Carton | Term. per Case |
|-----------------|--------------|----------------|--------------------------------|-------|-----------|------------------|------------------|----------------|
| MNG18-250DMFX-A | 051138-98059 | 22 - 18 AWG | 0.250" | 0.91" | 0.032" | 0.150" | 50 | 500 |
| MNG14-250DMFK-A | 051138-98067 | 16 - 14 AWG | 0.250" | 0.91" | 0.032" | 0.190" | - | 1000 |
| MNG14-250DMFX-A | 051128-58873 | 16 - 14 AWG | 0.250" | 0.91" | 0.032" | 0.190" | 100 | 500 |

Vinyl Insulated Butted Seam Piggy-Back Disconnects

| | |
|----------------------|-------------|
| Terminal Type | Disconnect |
| Terminal Style | Piggy-Back |
| Fastener Orientation | Male-Female |
| Insulation Material | Vinyl |
| Barrel Style | Butted |
| RoHS 2011/65/EU | Yes |
| Manufacturing Origin | Taiwan |



| Order No. | UPC | Conductor Size | Mates with Male Tab Width (W') | (L) | Thickness | Barrel Length | Barrel I.D. | Max. Insul. Dia. | Term. per Carton | Term. per Case |
|-----------------|--------------|----------------|--------------------------------|-------|-----------|---------------|-------------|------------------|------------------|----------------|
| MVU18-250DMFX-A | 051128-58874 | 22 - 18 AWG | 0.250" | 0.87" | 0.032" | 0.23" | 0.070" | 0.150" | 100 | 500 |
| MVU18-250DMFK-A | 051138-98062 | 22 - 18 AWG | 0.250" | 0.87" | 0.032" | 0.23" | 0.070" | 0.150" | - | 1000 |
| MVU14-250DMFX-A | 051128-58872 | 16 - 14 AWG | 0.250" | 0.87" | 0.032" | 0.23" | 0.090" | 0.170" | 100 | 500 |
| MVU14-250DMFK-A | 051138-98073 | 16 - 14 AWG | 0.250" | 0.87" | 0.032" | 0.23" | 0.090" | 0.170" | - | 1000 |

Non-Insulated Double Male-Female Adapters

Terminal Type Disconnect
Terminal Style Adapter
Fastener Orientation Double Male-Female
Insulation Material Non-Insulated
Barrel Style Butted
RoHS 2011/65/EU Yes

Agency Approval  Except for MA250DMFM-A Adapters

Manufacturing Origin  Product numbers ending with "-A" are made in Taiwan.



| Order No. | UPC | Mates with Female and Male Tab Width (W') | (L) | Thickness | Terminals per Carton | Terminals per Case |
|--------------|--------------|---|-------|-----------|----------------------|--------------------|
| MA250DMFMK-A | 051128-57451 | 0.250" | 0.70" | 0.032" | - | 500 |
| MA250DMFMX-A | 051128-58875 | 0.250" | 0.70" | 0.032" | 100 | 500 |
| MA250DMMFK | 054007-02273 | 0.250" | 0.76" | 0.032" | - | 500 |
| MA250DMMFX | 051128-58781 | 0.250" | 0.76" | 0.032" | 50 | 500 |

Butted Seam 900°F (482°C) High Temperature Ring Tongues

| | |
|----------------------|---|
| Terminal Type | Ring |
| Terminal Style | High Temperature |
| Insulation Material | Non-Insulated |
| Barrel Style | Butted |
| RoHS 2011/65/EU | Yes |
| Manufacturing Origin |  |



| Order No. | UPC | Conductor Size | Stud Size | (W) | (C) | (L) | (E) | Thickness | Barrel I.D. | Terminals per Carton | Terminals per Case |
|--------------|--------------|----------------|-----------|-------|-------|-------|-------|-----------|-------------|----------------------|--------------------|
| MU18-6RHT/SX | 051128-58955 | 22 - 18 AWG | 6 | 0.25" | 0.22" | 0.60" | 0.47" | 0.030" | 0.070" | 100 | 500 |
| MU18-10RHTX | 051128-58956 | 22 - 18 AWG | 10 | 0.33" | 0.29" | 0.70" | 0.54" | 0.030" | 0.070" | 100 | 500 |
| MU18-10RHTK | 054007-01155 | 22 - 18 AWG | 10 | 0.33" | 0.29" | 0.70" | 0.54" | 0.030" | 0.070" | - | 1000 |
| MU14-6RHT/SX | 051128-58975 | 16 - 14 AWG | 6 | 0.25" | 0.22" | 0.60" | 0.47" | 0.030" | 0.090" | 100 | 500 |
| MU14-6RHT/SK | 054007-01758 | 16 - 14 AWG | 6 | 0.25" | 0.22" | 0.60" | 0.47" | 0.030" | 0.090" | - | 1000 |
| MU14-10RHTX | 051128-58771 | 16 - 14 AWG | 10 | 0.33" | 0.29" | 0.70" | 0.54" | 0.030" | 0.090" | 100 | 500 |
| MU14-10RHTK | 054007-01759 | 16 - 14 AWG | 10 | 0.33" | 0.29" | 0.70" | 0.54" | 0.030" | 0.090" | - | 1000 |
| MU14-14RHTX | 051128-58976 | 16 - 14 AWG | 1/4" | 0.56" | 0.40" | 0.93" | 0.65" | 0.030" | 0.090" | 100 | 500 |
| MU14-14RHTK | 054007-01760 | 16 - 14 AWG | 1/4" | 0.56" | 0.40" | 0.93" | 0.65" | 0.030" | 0.090" | - | 1000 |
| MU10-10RHTX | 051128-58772 | 12 - 10 AWG | 10 | 0.38" | 0.29" | 0.73" | 0.54" | 0.040" | 0.135" | 50 | 500 |
| MU10-10RHTK | 054007-02045 | 12 - 10 AWG | 10 | 0.38" | 0.29" | 0.73" | 0.54" | 0.040" | 0.135" | - | 500 |
| MU10-14RHTK | 054007-02046 | 12 - 10 AWG | 1/4" | 0.59" | 0.44" | 0.99" | 0.69" | 0.040" | 0.135" | - | 500 |
| MU8-14RHT/SK | 054007-02142 | 8 AWG | 1/4" | 0.47" | 0.40" | 0.95" | 0.71" | 0.050" | 0.185" | - | 200 |
| MU6-38RHTK | 054007-02171 | 6 AWG | 3/8" | 0.63" | 0.52" | 1.22" | 0.91" | 0.050" | 0.255" | - | 200 |
| MU4-38RHTK | 054007-02196 | 4 AWG | 3/8" | 0.68" | 0.53" | 1.34" | 1.00" | 0.075" | 0.285" | - | 200 |

Butted Seam 900°F (482°C) High Temperature Standard Forks

Terminal Type Fork
 Terminal Style High Temperature
 Insulation Material Non-Insulated
 Barrel Style Butted
 RoHS 2011/65/EU Yes
 Manufacturing Origin 

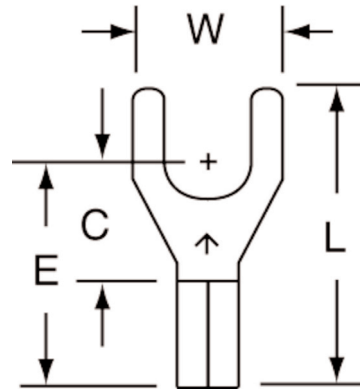

| Order No. | UPC | Conductor Size | Stud Size | (W) | (C) | (L) | (E) | Thickness | Barrel I.D. | Terminals per Carton | Terminals per Case |
|-------------|--------------|----------------|-----------|-------|-------|-------|-------|-----------|-------------|----------------------|--------------------|
| MU18-10FHTK | 054007-01333 | 22 - 18 AWG | 10 | 0.34" | 0.29" | 0.70" | 0.54" | 0.030" | 0.070" | - | 1000 |
| MU14-10FHTK | 054007-01842 | 16 - 14 AWG | 10 | 0.34" | 0.29" | 0.70" | 0.54" | 0.030" | 0.090" | - | 1000 |
| MU10-10FHTK | 054007-02095 | 12 - 10 AWG | 10 | 0.38" | 0.28" | 0.73" | 0.53" | 0.040" | 0.135" | - | 500 |

Butted Seam 900°F (482°C) High Temperature Block Forks

Terminal Type Fork
 Terminal Style High Temperature Block
 Insulation Material Non-Insulated
 Barrel Style Butted
 RoHS 2011/65/EU Yes
 Manufacturing Origin 

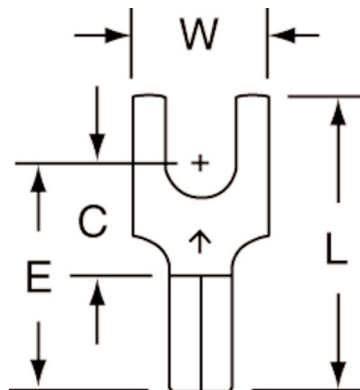

| Order No. | UPC | Conductor Size | Stud Size | (W) | (C) | (L) | (E) | Thickness | Barrel I.D. | Terminals per Carton | Terminals per Case |
|-------------|--------------|----------------|-----------|-------|-------|-------|-------|-----------|-------------|----------------------|--------------------|
| MU18-6FBHTK | 054007-01334 | 22 - 18 AWG | 6 | 0.30" | 0.25" | 0.65" | 0.50" | 0.030" | 0.070" | - | 1000 |
| MU14-6FBHTK | 054007-01843 | 16 - 14 AWG | 6 | 0.30" | 0.25" | 0.65" | 0.50" | 0.030" | 0.090" | - | 1000 |

Butted Seam 900°F (482°C) High Temperature Butt Connectors

| | |
|----------------------|---|
| Terminal Type | Butt |
| Terminal Style | High Temperature |
| Insulation Material | Non-Insulated |
| Barrel Style | Butted |
| RoHS 2011/65/EU | Yes |
| Manufacturing Origin |  |



| Order No. | UPC | Conductor Size | (L) | Thickness | Barrel Length | Barrel I.D. | Terminals per Carton | Terminals per Case |
|-----------|--------------|----------------|-------|-----------|---------------|-------------|----------------------|--------------------|
| MU18BCHTX | 051128-58957 | 22 - 18 AWG | 0.56" | 0.030" | 0.25" | 0.070" | 100 | 500 |
| MU18BCHTK | 054007-01299 | 22 - 18 AWG | 0.56" | 0.030" | 0.25" | 0.070" | - | 1000 |
| MU14BCHTX | 051128-58977 | 16 - 14 AWG | 0.56" | 0.030" | 0.25" | 0.090" | 100 | 500 |
| MU14BCHTK | 054007-01761 | 16 - 14 AWG | 0.56" | 0.030" | 0.25" | 0.090" | - | 1000 |
| MU10BCHTX | 051128-58989 | 12 - 10 AWG | 0.56" | 0.040" | 0.25" | 0.135" | 50 | 500 |
| MU10BCHTK | 054007-02232 | 12 - 10 AWG | 0.56" | 0.040" | 0.25" | 0.135" | - | 500 |

Butted Seam 900°F (482°C) High Temperature Female Disconnects

| | |
|----------------------|---|
| Terminal Type | Disconnect |
| Terminal Style | High Temperature |
| Fastener Orientation | Female |
| Insulation Material | Non-Insulated |
| Barrel Style | Butted |
| RoHS 2011/65/EU | Yes |
| Manufacturing Origin |  |



| Order No. | UPC | Conductor Size | Mates with Male Tab Width (W') | (L) | Thickness | Barrel Length | Barrel I.D. | Terminals per Carton | Terminals per Case |
|---------------|--------------|----------------|--------------------------------|-------|-----------|---------------|-------------|----------------------|--------------------|
| MU14-187DFHTK | 054007-01762 | 16 - 14 AWG | 0.187" | 0.58" | 0.020" | 0.25" | 0.085" | - | 1000 |
| MU14-250DFHTK | 054007-01763 | 16 - 14 AWG | 0.250" | 0.64" | 0.032" | 0.23" | 0.095" | - | 1000 |
| MU14-250DFHTX | 051128-58978 | 16 - 14 AWG | 0.250" | 0.64" | 0.032" | 0.23" | 0.095" | 100 | 500 |

Butted Seam Flag 900°F (482°C) High Temperature Female Disconnects

| | |
|----------------------|---|
| Terminal Type | Disconnect |
| Terminal Style | High Temperature Flag |
| Fastener Orientation | Female |
| Insulation Material | Non-Insulated |
| Barrel Style | Butted |
| RoHS 2011/65/EU | Yes |
| Manufacturing Origin |  |



| Order No. | UPC | Conductor Size | Mates with Male Tab Width (W') | (L) | Thickness | Barrel Length | Barrel I.D. | Terminals per Carton | Terminals per Case |
|--------------------|--------------|----------------|--------------------------------|-------|-----------|---------------|-------------|----------------------|--------------------|
| MU14-250DFHT/FLAGK | 054007-01839 | 16 - 14 AWG | 0.250" | 0.51" | 0.032" | 0.26" | 0.095" | - | 1000 |

Butted Seam 900°F (482°C) High Temperature Male Disconnects

| | |
|----------------------|---|
| Terminal Type | Disconnect |
| Terminal Style | High Temperature |
| Fastener Orientation | Male |
| Insulation Material | Non-Insulated |
| Barrel Style | Butted |
| RoHS 2011/65/EU | Yes |
| Manufacturing Origin |  |



| Order No. | UPC | Conductor Size | Male Tab Width (W') | (L) | Thickness | Barrel Length | Barrel I.D. | Terminals per Carton | Terminals per Case |
|---------------|--------------|----------------|---------------------|-------|-----------|---------------|-------------|----------------------|--------------------|
| MU14-250DMHTX | 051128-58979 | 16 - 14 AWG | 0.250" | 0.73" | 0.032" | 0.25" | 0.090" | 100 | 500 |
| MU14-250DMHTK | 054007-01765 | 16 - 14 AWG | 0.250" | 0.73" | 0.032" | 0.25" | 0.090" | - | 1000 |

Nylon Insulated with Insulation Grip Pin Terminals

| | |
|----------------------|-----------------|
| Terminal Type | Pin |
| Insulation Material | Nylon |
| Barrel Style | Insulation Grip |
| RoHS 2011/65/EU | Yes |
| Manufacturing Origin | Taiwan |



| Order No. | UPC | Conductor Size | (L) | Pin Length (PL) | Pin Diameter | Max. Insul. Dia. | Terminals per Carton | Terminals per Case |
|--------------|--------------|----------------|-------|-----------------|--------------|------------------|----------------------|--------------------|
| MNG18-47PX-A | 051128-58845 | 22 - 18 AWG | 0.90" | 0.47" | 0.075" | 0.170" | 100 | 500 |
| MNG14-47PK-A | 051138-98166 | 16 - 14 AWG | 0.90" | 0.47" | 0.075" | 0.200" | - | 1000 |
| MNG14-47PX-A | 051128-58775 | 16 - 14 AWG | 0.90" | 0.47" | 0.075" | 0.200" | 100 | 500 |
| MNG10-55PK-A | 051138-98177 | 12 - 10 AWG | 1.06" | 0.55" | 0.110" | 0.270" | - | 500 |
| MNG10-55PX-A | 051128-58864 | 12 - 10 AWG | 1.06" | 0.55" | 0.110" | 0.270" | 50 | 500 |

Vinyl Insulated Butted Seam Pin Terminals

| | |
|----------------------|--------|
| Terminal Type | Pin |
| Insulation Material | Vinyl |
| Barrel Style | Butted |
| RoHS 2011/65/EU | Yes |
| Manufacturing Origin | Taiwan |



| Order No. | UPC | Conductor Size | (L) | Max. Insul. Dia. | Pin Length (PL) | Pin Diameter | Terminals per Carton | Terminals per Case |
|--------------|--------------|----------------|-------|------------------|-----------------|--------------|----------------------|--------------------|
| MVU18-47PX-A | 051128-58871 | 22 - 18 AWG | 0.90" | 0.150" | 0.47" | 0.075" | 100 | 500 |
| MVU18-47PK-A | 051138-98111 | 22 - 18 AWG | 0.90" | 0.150" | 0.47" | 0.075" | - | 1000 |
| MVU14-47PX-A | 051128-58865 | 16 - 14 AWG | 0.90" | 0.170" | 0.47" | 0.075" | 100 | 500 |
| MVU14-47PK-A | 051138-98171 | 16 - 14 AWG | 0.90" | 0.170" | 0.47" | 0.075" | - | 1000 |
| MVU10-55PX-A | 051128-58863 | 12 - 10 AWG | 1.06" | 0.250" | 0.55" | 0.110" | 50 | 500 |
| MVU10-55PK-A | 051138-98182 | 12 - 10 AWG | 1.06" | 0.250" | 0.55" | 0.110" | - | 500 |

Non-Insulated Butted Seam Pin Terminals

| | |
|----------------------|---------------|
| Terminal Type | Pin |
| Insulation Material | Non-Insulated |
| Barrel Style | Butted |
| RoHS 2011/65/EU | Yes |
| Manufacturing Origin | Taiwan |



| Order No. | UPC | Conductor Size | (L) | Pin Length (PL) | Pin Diameter | Terminals per Carton | Terminals per Case |
|-------------|--------------|----------------|-------|-----------------|--------------|----------------------|--------------------|
| MU18-47PX-A | 051128-58877 | 22 - 18 AWG | 0.73" | 0.47" | 0.080" | 100 | 500 |
| MU14-47PK-A | 051128-57441 | 16 - 14 AWG | 0.73" | 0.47" | 0.080" | - | 1000 |
| MU14-47PX-A | 051128-58876 | 16 - 14 AWG | 0.73" | 0.47" | 0.080" | 100 | 500 |
| MU10-55PX-A | 051128-58754 | 12 - 10 AWG | 0.81" | 0.55" | 0.110" | 50 | 500 |

Closed End Connectors

3M™ Scotchlok™ electrical crimp sleeve connectors make fast work of splicing 22 to 10 AWG copper conductors. Smooth flared entry makes wire insertion fast — simply twist conductors together and crimp. The S-11-A and S-31-A connectors are insulated, closed-end crimp sleeve connectors with a copper insert. The rugged and resilient nylon insulator allows these connectors to be used in light fixtures, appliances and other electrical OEM applications.

| | |
|------------------------------------|------------|
| Terminal Type | Closed End |
| Insulation Material | Nylon |
| Maximum Voltage | 600 Volt |
| Maximum Operating Temperature (°F) | 221 °F |
| Maximum Operating Temperature (°C) | 105 °C |
| Manufacturing Origin | Taiwan |



S-31

| Order No. | UPC | Maximum Wire Gauge | Minimum Wire Gauge | (L) | Cu Solid/Stranded Wire Combinations | Terminals per Carton | Terminals per Case |
|----------------|--------------|--------------------|--------------------|-------|--|----------------------|--------------------|
| S-11-A (BULK) | 051138-98052 | 22 AWG | 16 AWG | 0.83" | 2- 5 #22; 1-4 #22 with 1-2 #20; 1-3 #22 with 1 #18; 1 #22 with 1 #16; 2-3 #20 | - | 10000 |
| S-11-A (BOXED) | 051128-58997 | 22 AWG | 16 AWG | 0.83" | 2-5 #22; 1-4 #22 with 1-2 #20; 1-3 #22 with 1 #18; 1 #22 with 1 #16; 2-3 #20 | 100 | 500 |
| S-31-A (BULK) | 051138-98044 | 18 AWG | 10 AWG | 1.00" | 1 #22 with 1 #12 or #10; 1 #22 with 2 #14 or #16; 1 #22 with 1 #20 with 1 #12 or #14; 1 #22 with 1 #18 with 1 #12 or #14; 1 #22 with 1 #16 with 1 #12 or #14; 1 #22 with 1 #14 with 1 #12; 1-2 #20 with 1-2 #14; 1-2 #20 with 1 #12; 1 #20 with 1 #10; 1 #20 with 1 #16 with 1 #12; 1 #18 with 1 #14; 1 #18 with 1 #12; 1 #18 with 2 #16; 1 #18 with 1 #16 with 1 #12 or #14; 1 #16 with 1 #12 or #14; 3 #16; 1 #14 with 1 #12; 2 #14. | - | 5000 |
| S-31-A (BOXED) | 051128-58996 | 18 AWG | 10 AWG | 1.00" | 1 #22 with 1 #12 or #10; 1 #22 with 2 #14 or #16; 1 #22 with 1 #20 with 1 #12 or #14; 1 #22 with 1 #18 with 1 #12 or #14; 1 #22 with 1 #16 with 1 #12 or #14; 1 #22 with 1 #14 with 1 #12; 1-2 #20 with 1-2 #14; 1-2 #20 with 1 #12; 1 #20 with 1 #10; 1 #20 with 1 #16 with 1 #12; 1 #18 with 1 #14; 1 #18 with 1 #12; 1 #18 with 2 #16; 1 #18 with 1 #16 with 1 #12 or #14; 1 #16 with 1 #12 or #14; 3 #16; 1 #14 with 1 #12; 2 #14. | 50 | 500 |

Vinyl Insulated Butted Seam Parallel Connectors

Terminal Type Parallel Connector
 Insulation Material Vinyl
 Barrel Style Butted
 RoHS 2011/65/EU Yes



Manufacturing Origin



| Order No. | UPC | Conductor Size | (L) | Thickness | Barrel I.D. | Max. Insul. Dia. | Cu Stranded Wire Combinations | Terminals per Case | Terminals per Carton |
|-----------|--------------|----------------|-------|-----------|-------------|------------------|---|--------------------|----------------------|
| MVU18PCK | 054007-01318 | 22 - 18 AWG | 0.67" | 0.030" | 0.070" | 0.145" | 1 #22 to 1 #22, 20, 18, 16; 1 #20 to 1 #20, 18, 16; 1 #18 to 1 #18 | 1000 | |
| MVU14PCK | 054007-01824 | 16 - 14 AWG | 0.67" | 0.030" | 0.090" | 0.170" | 1 #22 to 1 #22, 20, 18, 16, 14; 1 #20 to 1 #20, 18, 16, 14; 1 #18 to 1 #18, 16, 14; 1 #16 to 1 #16. | 1000 | - |
| MVU10PCK | 054007-02084 | 12 - 10 AWG | 0.87" | 0.040" | 0.135" | 0.250" | 1 #18 to 1 #18, 16, 14, 12, 10; 1 #16 to 1 #16, 14, 12, 10; 1 #14 to 1 #14, 12. | 500 | - |

3M™ Highland™ Terminals

3M Highland terminals, disconnects, and connectors are for use in the assembly and maintenance of electrical systems. 3M Highland terminals offer effective and reliable performance in a variety of types of general applications. Available in low quantity, reclosable bags, 3M Highland terminals are the optimal choice for smaller jobs.



| Section | Page |
|---|--------------|
| 3M™ Highland™ Terminals | 71-77 |
| 3M™ Highland™ Ring Tongues..... | 72 |
| Vinyl Insulated Butted Seam – Ring Tongues..... | 72 |
| 3M™ Highland™ Standard Forks..... | 73 |
| Vinyl Insulated Butted Seam – Standard Forks..... | 73 |
| 3M™ Highland™ Block Forks | 74 |
| Vinyl Insulated Butted Seam – Block Forks | 74 |
| 3M™ Highland™ Locking Forks..... | 75 |
| Vinyl Insulated Butted Seam – Locking Forks..... | 75 |
| 3M™ Highland™ Butt Splices..... | 75 |
| Vinyl Insulated Butted Seam – Butt Splices..... | 75 |
| 3M™ Highland™ Female Disconnects | 76 |
| Nylon Fully Insulated Butted Seam – Female Disconnects..... | 76 |
| Vinyl Insulated Butted Seam – Female Disconnects | 76 |
| 3M™ Highland™ Male Disconnects..... | 77 |
| Nylon Fully Insulated Butted Seam – Male Disconnects | 77 |
| Vinyl Insulated Butted Seam – Male Disconnects..... | 77 |

3M™ Highland™ Terminals: 3M™ Highland™ Ring Tongues

Vinyl Insulated Butted Seam – Ring Tongues

Terminal Type Ring
 Terminal Style Standard
 Insulation Material Vinyl
 Barrel Style Butted

RoHS 2011/65/EU Yes

Agency Approval



Manufacturing Origin

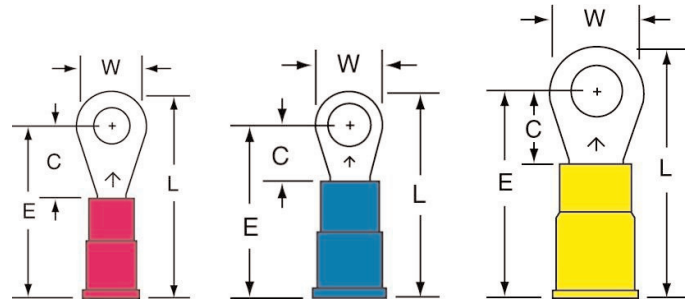

| Order No. | UPC | Conductor Size | Stud Size | Terminals per Bag |
|-----------|--------------|----------------|-----------|-------------------|
| RV18-6Q | 051128-60045 | 22 - 18 AWG | 6 | 25 |
| RV18-10Q | 051128-60043 | 22 - 18 AWG | 10 | 25 |
| RV18-8Q | 051128-60046 | 22 - 18 AWG | 8 | 25 |
| RV18-14Q | 051128-60044 | 22 - 18 AWG | 1/4" | 25 |
| RV14-6Q | 051128-60041 | 16 - 14 AWG | 6 | 25 |
| RV14-10Q | 051128-60038 | 16 - 14 AWG | 10 | 25 |
| RV14-8Q | 051128-60042 | 16 - 14 AWG | 8 | 25 |
| RV14-14Q | 051128-60039 | 16 - 14 AWG | 1/4" | 25 |
| RV14-516Q | 051128-60040 | 16 - 14 AWG | 5/16" | 25 |
| RV10-10Q | 051128-60032 | 12 - 10 AWG | 10 | 25 |
| RV10-6Q | 051128-60036 | 12 - 10 AWG | 6 | 25 |
| RV10-8Q | 051128-60037 | 12 - 10 AWG | 8 | 25 |
| RV10-14Q | 051128-60033 | 12 - 10 AWG | 1/4" | 25 |
| RV10-516Q | 051128-60035 | 12 - 10 AWG | 5/16" | 25 |
| RV10-38Q | 051128-60034 | 12 - 10 AWG | 3/8" | 25 |

Vinyl Insulated Butted Seam – Standard Forks

| | |
|----------------------|---|
| Terminal Type | Fork |
| Terminal Style | Standard |
| Insulation Material | Vinyl |
| Barrel Style | Butted |
| RoHS 2011/65/EU | Yes |
| Agency Approval |  |
| Manufacturing Origin |  |



| Order No. | UPC | Conductor Size | Stud Size | Terminals per Bag |
|-----------|--------------|----------------|-----------|-------------------|
| FV14-6Q | 051128-60012 | 16 - 14 AWG | 6 | 25 |
| FV14-8Q | 051128-60013 | 16 - 14 AWG | 8 | 25 |
| FV14-10Q | 051128-60011 | 16 - 14 AWG | 10 | 25 |
| FV10-8Q | 051128-60010 | 12 - 10 AWG | 8 | 25 |
| FV10-10Q | 051128-60009 | 12 - 10 AWG | 10 | 25 |

Vinyl Insulated Butted Seam – Block Forks

Terminal Type Fork
 Terminal Style Block
 Insulation Material Vinyl
 Barrel Style Butted
 RoHS 2011/65/EU Yes

Agency Approval



Manufacturing Origin

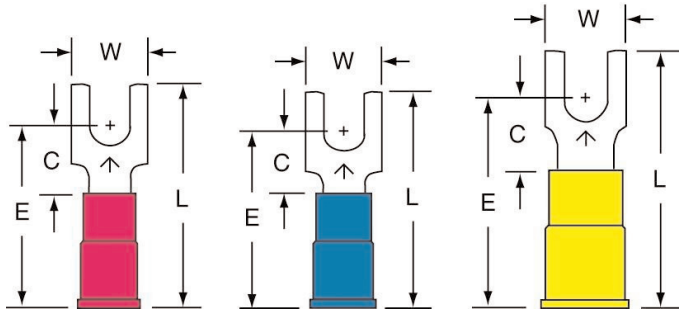

| Order No. | UPC | Conductor Size | Stud Size | Terminals per Bag |
|-----------|--------------|----------------|-----------|-------------------|
| BFV18-6Q | 051128-59994 | 22 - 18 AWG | 6 | 25 |
| BFV18-8Q | 051128-59995 | 22 - 18 AWG | 8 | 25 |
| BFV18-10Q | 051128-59993 | 22 - 18 AWG | 10 | 25 |
| BFV14-6Q | 051128-59991 | 16 - 14 AWG | 6 | 25 |
| BFV14-8Q | 051128-59992 | 16 - 14 AWG | 8 | 25 |
| BFV14-10Q | 051128-59990 | 16 - 14 AWG | 10 | 25 |
| BFV10-6Q | 051128-59988 | 12 - 10 AWG | 6 | 25 |
| BFV10-8Q | 051128-59989 | 12 - 10 AWG | 8 | 25 |
| BFV10-10Q | 051128-59987 | 12 - 10 AWG | 10 | 25 |

3M™ Highland™ Terminals: 3M™ Highland™ Locking Forks

Vinyl Insulated Butted Seam – Locking Forks

Terminal Type Fork
Terminal Style Locking
Insulation Material Vinyl
Barrel Style Butted
RoHS 2011/65/EU Yes
Agency Approval 
Manufacturing Origin 

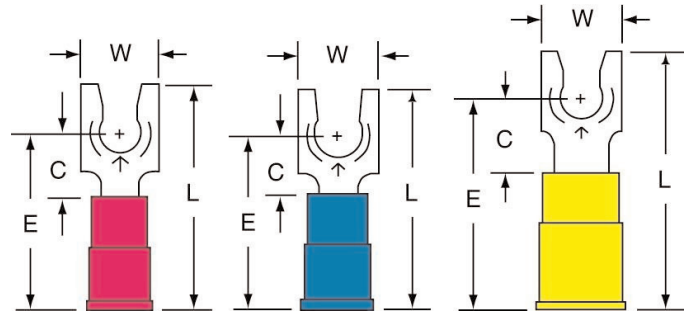

| Order No. | UPC | Conductor Size | Stud Size | Terminals per Bag |
|-----------|--------------|----------------|-----------|-------------------|
| LFV18-8Q | 051128-60021 | 22 - 18 AWG | 8 | 25 |
| LFV18-6Q | 051128-60020 | 22 - 18 AWG | 6 | 25 |
| LFV14-8Q | 051128-60019 | 16 - 14 AWG | 8 | 25 |
| LFV14-6Q | 051128-60018 | 16 - 14 AWG | 6 | 25 |
| LFV14-10Q | 051128-60017 | 16 - 14 AWG | 10 | 25 |
| LFV10-6Q | 051128-60015 | 12 - 10 AWG | 6 | 25 |
| LFV10-8Q | 051128-60016 | 12 - 10 AWG | 8 | 25 |
| LFV10-10Q | 051128-60014 | 12 - 10 AWG | 10 | 25 |

3M™ Highland™ Terminals: 3M™ Highland™ Butt Splices

Vinyl Insulated Butted Seam – Butt Splices

Terminal Type Butt
Terminal Style Standard
Insulation Material Vinyl
Barrel Style Butted
RoHS 2011/65/EU Yes
Agency Approval 
Manufacturing Origin 



| Order No. | UPC | Conductor Size | Terminals per Bag |
|-----------|--------------|----------------|-------------------|
| BSV18Q | 051128-59998 | 22 - 18 AWG | 25 |
| BSV14Q | 051128-59997 | 16 - 14 AWG | 25 |
| BSV10Q | 051128-59996 | 12 - 10 AWG | 25 |

Nylon Fully Insulated Butted Seam – Female Disconnects

Terminal Type Disconnect
 Terminal Style Fully Insulated
 Fastener Orientation Female
 Insulation Material Nylon
 Barrel Style Butted
 RoHS 2011/65/EU Yes

Agency Approval  



Manufacturing Origin 



| Order No. | UPC | Conductor Size | Mates with Male Tab Width (W') | Terminals per Bag |
|------------|--------------|----------------|--------------------------------|-------------------|
| FDI18-187Q | 051128-60002 | 22 - 18 AWG | 0.187" | 25 |
| FDI18-250Q | 051128-60003 | 22 - 18 AWG | 0.250" | 25 |
| FDI14-187Q | 051128-60000 | 16 - 14 AWG | 0.187" | 25 |
| FDI14-250Q | 051128-60001 | 16 - 14 AWG | 0.250" | 25 |
| FDI10-250Q | 051128-59999 | 12 - 10 AWG | 0.250" | 25 |

Vinyl Insulated Butted Seam – Female Disconnects

Terminal Type Disconnect
 Terminal Style Standard
 Fastener Orientation Female
 Insulation Material Vinyl
 Barrel Style Butted
 RoHS 2011/65/EU Yes

Agency Approval  

Manufacturing Origin 



| Order No. | UPC | Conductor Size | Mates with Male Tab Width (W') | Terminals per Bag |
|------------|--------------|----------------|--------------------------------|-------------------|
| FDV18-187Q | 051128-60007 | 22 - 18 AWG | 0.187" | 25 |
| FDV18-250Q | 051128-60008 | 22 - 18 AWG | 0.250" | 25 |
| FDV14-187Q | 051128-60005 | 16 - 14 AWG | 0.187" | 25 |
| FDV14-250Q | 051128-60006 | 16 - 14 AWG | 0.250" | 25 |
| FDV10-250Q | 051128-60004 | 12 - 10 AWG | 0.250" | 25 |

Nylon Fully Insulated Butted Seam – Male Disconnects

| | |
|----------------------|---|
| Terminal Type | Disconnect |
| Terminal Style | Fully Insulated |
| Fastener Orientation | Male |
| Insulation Material | Nylon |
| Barrel Style | Butted |
| RoHS 2011/65/EU | Yes |
| Agency Approval |   |
| Manufacturing Origin |  |



| Order No. | UPC | Conductor Size | Mates with Male Tab Width (W') | Terminals per Bag |
|------------|--------------|----------------|--------------------------------|-------------------|
| MTI18-187Q | 051128-60025 | 22 - 18 AWG | 0.187" | 25 |
| MTI18-250Q | 051128-60026 | 22 - 18 AWG | 0.250" | 25 |
| MTI14-187Q | 051128-60023 | 16 - 14 AWG | 0.187" | 25 |
| MTI14-250Q | 051128-60024 | 16 - 14 AWG | 0.250" | 25 |
| MTI10-250Q | 051128-60022 | 12 - 10 AWG | 0.250" | 25 |

Vinyl Insulated Butted Seam – Male Disconnects

| | |
|----------------------|---|
| Terminal Type | Disconnect |
| Terminal Style | Standard |
| Fastener Orientation | Male |
| Insulation Material | Vinyl |
| Barrel Style | Butted |
| RoHS 2011/65/EU | Yes |
| Agency Approval |   |
| Manufacturing Origin |  |



| Order No. | UPC | Conductor Size | Mates with Male Tab Width (W') | Terminals per Bag |
|------------|--------------|----------------|--------------------------------|-------------------|
| MTV18-187Q | 051128-60030 | 22 - 18 AWG | 0.187" | 25 |
| MTV18-250Q | 051128-60031 | 22 - 18 AWG | 0.250" | 25 |
| MTV14-187Q | 051128-60028 | 16 - 14 AWG | 0.187" | 25 |
| MTV14-250Q | 051128-60029 | 16 - 14 AWG | 0.250" | 25 |
| MTV10-250Q | 051128-60027 | 12 - 10 AWG | 0.250" | 25 |

Kits and Tools

3M™ Scotchlok™ Terminal Kit STK-1 (Filled)

The 3M™ Scotchlok™ Terminal Kit is filled with 3M's most frequently purchased low voltage termination products, including 14 of our most popular terminals.

The STK-1 kit is constructed of durable metal with individual product compartments. While the compartments keep you organized, the rugged metal frame protects the contents even in harsh environments. This kit contains: 1 3M™ Scotchlok™ Crimping Tool TH-440; 1 3M™ ScotchCode™ Tape Dispenser STD-0-9; 100 3M™ Cable Ties 06225; 100 3M™ Cable Ties 06226; 50 3M™ Highland™ Ring Tongue Terminal RV18-6; 50 3M™ Highland™ Ring Tongue Terminal RV18-8; 50 3M™ Highland™ Ring Tongue Terminal RV14-6; 50 3M™ Highland™ Ring Tongue Terminal RV14-8; 50 3M™ Highland™ Ring Tongue Terminal RV14-10; 25 3M™ Highland™ Ring Tongue Terminal RV10-10; 50 3M™ Highland™ Block Fork Terminal BFV14-8; 50 3M™ Highland™ Block Fork Terminal BFV14-10; 50 3M™ Highland™ Block Fork Terminal BFV18-8; 50 3M™ Highland™ Block Fork Terminal BFV18-6; 50 3M™ Highland™ Butt Connector BSV18; 50 3M™ Highland™ Butt Connector BSV14; 25 3M™ Highland™ Butt Connector BSV10; 50 3M™ Highland™ Female Disconnect FDV14-250





| Order No. | UPC | Description | Color |
|-----------|--------------|---|-------|
| STK-1 | 051138-25348 | Overall box size is 13-3/4" L x 10" W x 2-1/2" H. | Red |

3M™ Scotchlok™ Terminal Boxes (Empty)

Manufacturing Origin



| | RED-TERMINAL-BOX | CLEAR-TERMINAL-BOX |
|-------------|--|--|
| |  |  |
| UPC | 054007-11900 | 051128-57758 |
| Description | This metal case with plastic insert tray is divided into 14 terminal compartments, one tool compartment and two miscellaneous compartments. Order contents separately. | This plastic organizing box for terminals is divided into 13 compartments, including one sized to hold a crimping tool. Order contents separately. |
| Color | Red | Clear |

3M™ Tools

Manufacturing Origin



| | TH-440 | TH-450 | TR-482 | TR-490 |
|--------------|--|--|---|---|
| |  |  |  |  |
| UPC | 054007-30120 | 054007-49575 | 054007-11902 | 054007-70481 |
| Product Name | 3M™ Scissors, Style TH-440 | 3M™ Scissors, Style TH-450 | 3M™ Ratchet, Style TR-482 | 3M™ Ratchet, Style TR-490 |
| Description | High carbon, heat-treated steel crimping tool that has a unique design that provides a high strength/weight ratio that crimps a broad range of 22-10 AWG terminals and connectors. | One of the most versatile heavy-duty tools 3M has offered. It is made of high-strength, heat-treated carbon steel. | This tool crimps the barrel and insulation grip simultaneously on 22–10 AWG insulated terminals and connectors. The 3M™ Ratchet Style TR-482 will crimp nylon or vinyl insulated, butted or brazed seam terminals and connectors. | This tool crimps the barrel and insulation grip independently on 22–10 AWG insulated and non-insulated terminals and connectors, nylon or vinyl insulated, butted or brazed seam. |
| Range | 22-10 AWG | 26-6 AWG | 22-10 AWG | 22-10 AWG |



Index by Product Number

| Product Number | Page | Product Number | Page | Product Number | Page |
|--------------------|------|----------------|------|----------------|------|
| BFV10-10Q | 74 | M10-12RK | 18 | M14-6FX | 26 |
| BFV10-6Q | 74 | M10-14FLK | 38 | M14-6R/LK | 18 |
| BFV10-8Q | 74 | M10-14FLX | 38 | M14-6R/SK | 18 |
| BFV14-10Q | 74 | M10-14R/SK | 18 | M14-6R/SX | 18 |
| BFV14-6Q | 74 | M10-14R/SX | 18 | M14-8FBK | 30 |
| BFV14-8Q | 74 | M10-38R/SK | 18 | M14-8FBX | 30 |
| BFV18-10Q | 74 | M10-38R/SX | 18 | M14-8FLX | 38 |
| BFV18-6Q | 74 | M10-4R/SK | 18 | M14-8FX | 26 |
| BFV18-8Q | 74 | M10-516R/SX | 18 | M14-8R/LK | 18 |
| BSV10Q | 75 | M10-6FBK | 30 | M14-8R/LX | 18 |
| BSV14Q | 75 | M10-6FBX | 30 | M14BCK | 43 |
| BSV18Q | 75 | M10-6FK | 26 | M14BCX | 43 |
| CLEAR-TERMINAL-BOX | 78 | M10-6FX | 26 | M18-10FBK | 30 |
| FDI10-250Q | 76 | M10-6RK | 18 | M18-10FBX | 30 |
| FDI14-187Q | 76 | M10-6RX | 18 | M18-10FLX | 38 |
| FDI14-250Q | 76 | M10-8FBK | 30 | M18-10FX | 26 |
| FDI18-187Q | 76 | M10-8FBX | 30 | M18-10R/LK | 18 |
| FDI18-250Q | 76 | M10-8FK | 26 | M18-10R/LX | 18 |
| FDV10-250Q | 76 | M10-8FLX | 38 | M18-14R/SX | 18 |
| FDV14-187Q | 76 | M10-8FX | 26 | M18-38RX | 18 |
| FDV14-250Q | 76 | M10-8RK | 18 | M18-4R/SX | 18 |
| FDV18-187Q | 76 | M10-8RX | 18 | M18-6FB/SX | 30 |
| FDV18-250Q | 76 | M10BCK | 43 | M18-6FBX | 30 |
| FV10-10Q | 73 | M10BCX | 43 | M18-6FLK | 38 |
| FV10-8Q | 73 | M14-10FBX | 30 | M18-6FLX | 38 |
| FV14-10Q | 73 | M14-10FFBK | 33 | M18-6FX | 26 |
| FV14-6Q | 73 | M14-10FK | 26 | M18-6R/SK | 18 |
| FV14-8Q | 73 | M14-10FLK | 38 | M18-6R/SX | 18 |
| LFV10-10Q | 75 | M14-10FLX | 38 | M18-8FBK | 30 |
| LFV10-6Q | 75 | M14-10FX | 26 | M18-8FBX | 30 |
| LFV10-8Q | 75 | M14-10R/LK | 18 | M18-8FLX | 38 |
| LFV14-10Q | 75 | M14-10R/LX | 18 | M18-8FX | 26 |
| LFV14-6Q | 75 | M14-10RK | 18 | M18-8R/LK | 18 |
| LFV14-8Q | 75 | M14-14FLX | 38 | M18-8R/LX | 18 |
| LFV18-6Q | 75 | M14-14R/SK | 18 | M18BCK | 43 |
| LFV18-8Q | 75 | M14-14R/SX | 18 | M18BCX | 43 |
| M10-10FBK | 30 | M14-38RX | 18 | M4-10RX | 19 |
| M10-10FBX | 30 | M14-4R/SX | 18 | M4-12R/SK | 19 |
| M10-10FFBK | 33 | M14-516R/SK | 18 | M4-14RK | 19 |
| M10-10FK | 26 | M14-6FB/SK | 30 | M4-14RX | 19 |
| M10-10FLK | 38 | M14-6FB/SX | 30 | M4-38RK | 19 |
| M10-10FLX | 38 | M14-6FBK | 30 | M4-38RX | 19 |
| M10-10FX | 26 | M14-6FBX | 30 | M4-516RK | 19 |
| M10-10RK | 18 | M14-6FLK | 38 | M4-516RX | 19 |
| M10-10RX | 18 | M14-6FLX | 38 | M4BCK | 44 |

Index by Product Number

| Product Number | Page | Product Number | Page | Product Number | Page |
|-------------------|------|-------------------|------|------------------|------|
| M4BCX..... | 44 | MC3/0-12RX..... | 22 | MH18-10FLX..... | 34 |
| M6-10R/SK..... | 19 | MC3/0-38RX..... | 22 | MH18-10R/LK..... | 12 |
| M6-10R/SX..... | 19 | MC3/0BCX..... | 44 | MH18-10R/LX..... | 12 |
| M6-12R/SK..... | 19 | MC4/0-12RX..... | 22 | MH18-6FLK..... | 34 |
| M6-14R/SK..... | 19 | MC4/0-38RX..... | 22 | MH18-6FLX..... | 34 |
| M6-14R/SX..... | 19 | MC4/0BCX..... | 44 | MH18-6R/LK..... | 12 |
| M6-38RK..... | 19 | MH10-10FLK..... | 35 | MH18-6R/LX..... | 12 |
| M6-38RX..... | 19 | MH10-10FLX..... | 35 | MH18-8FLK..... | 34 |
| M6-516RK..... | 19 | MH10-10RK..... | 12 | MH18-8FLX..... | 34 |
| M6-516RX..... | 19 | MH10-10RX..... | 12 | MH18-8R/LK..... | 12 |
| M6BCK..... | 44 | MH10-14FLK..... | 35 | MH18-8R/LX..... | 12 |
| M6BCX..... | 44 | MH10-14FLX..... | 35 | MH18BCK..... | 40 |
| M8-10R/SK..... | 19 | MH10-14RK..... | 12 | MH18BCX..... | 40 |
| M8-10R/SX..... | 18 | MH10-14RX..... | 12 | MI10-250DFK..... | 54 |
| M8-12R/SK..... | 19 | MH10-38RK..... | 12 | MI10-250DFX..... | 54 |
| M8-14R/SK..... | 19 | MH10-38RX..... | 12 | MI18-250DFK..... | 54 |
| M8-14R/SX..... | 19 | MH10-8FLK..... | 35 | MN10BCK-A..... | 40 |
| M8-38RK..... | 19 | MH10-8FLX..... | 35 | MN10BCX..... | 40 |
| M8-38RX..... | 19 | MH10-8RK..... | 12 | MN10BCX-A..... | 40 |
| M8-516RK..... | 19 | MH10-8RX..... | 12 | MN14BCK-A..... | 40 |
| M8-516RX..... | 19 | MH10BCK..... | 40 | MN14BCX..... | 40 |
| M8BCK..... | 44 | MH10BCX..... | 40 | MN14BCX-A..... | 40 |
| M8BCX..... | 44 | MH14-10FLK..... | 35 | MN18BCK-A..... | 40 |
| MA250DMFMK-A..... | 62 | MH14-10FLX..... | 34 | MN18BCX..... | 40 |
| MA250DMFMX-A..... | 62 | MH14-10R/LK..... | 12 | MN18BCX-A..... | 40 |
| MA250DMMFK..... | 62 | MH14-10R/LX..... | 12 | MN24-2RK..... | 15 |
| MA250DMMFX..... | 62 | MH14-14FLK..... | 35 | MN24-4RK..... | 15 |
| MC1/0-12RX..... | 22 | MH14-14FLX..... | 35 | MN24-6RK..... | 15 |
| MC1/0-14RX..... | 22 | MH14-14R/SK..... | 12 | MN24-8RK..... | 15 |
| MC1/0-38RX..... | 22 | MH14-14R/SX..... | 12 | MN4-10RK..... | 14 |
| MC1/0BCX..... | 44 | MH14-38RK..... | 12 | MN4-12R/SK..... | 14 |
| MC1-14RX..... | 22 | MH14-38RX..... | 12 | MN4-14RK..... | 14 |
| MC1-38RX..... | 22 | MH14-516R/SK..... | 12 | MN4-38RK..... | 14 |
| MC1-516RX..... | 22 | MH14-516R/SX..... | 12 | MN4-38RX..... | 14 |
| MC1BCX..... | 44 | MH14-6FLK..... | 34 | MN4-516RK..... | 14 |
| MC2/0-12RX..... | 22 | MH14-6FLX..... | 34 | MN6-10R/SK..... | 14 |
| MC2/0-38RX..... | 22 | MH14-6R/LK..... | 12 | MN6-12R/SK..... | 14 |
| MC2/0BCX..... | 44 | MH14-6R/LX..... | 12 | MN6-14R/SK..... | 14 |
| MC2-14RX..... | 22 | MH14-8FLK..... | 34 | MN6-14R/SX..... | 14 |
| MC2-38RX..... | 22 | MH14-8FLX..... | 34 | MN6-38RK..... | 14 |
| MC250-12RX..... | 22 | MH14-8R/LK..... | 12 | MN6-38RX..... | 14 |
| MC250-38RX..... | 22 | MH14-8R/LX..... | 12 | MN6-516RK..... | 14 |
| MC250BCX..... | 44 | MH14BCK..... | 40 | MN8-10R/SK..... | 14 |
| MC2-516RX..... | 22 | MH14BCX..... | 40 | MN8-12R/SK..... | 15 |
| MC2BCX..... | 44 | MH18-10FLK..... | 34 | MN8-14R/SK..... | 14 |

Index by Product Number

| Product Number | Page | Product Number | Page | Product Number | Page |
|-----------------------|-------------|-----------------------|-------------|-----------------------|-------------|
| MN8-14R/SX..... | 14 | MNG10-8FLX..... | 36 | MNG14-250DMIX..... | 56 |
| MN8-38RK..... | 15 | MNG10-8FX..... | 23 | MNG14-250DMK..... | 58 |
| MN8-38RX..... | 14 | MNG10-8RK..... | 14 | MNG14-250DMX..... | 58 |
| MN8-516RK..... | 14 | MNG10-8RX..... | 14 | MNG14-38RK..... | 13 |
| MNG10-10FBK..... | 27 | MNG10BCK..... | 41 | MNG14-38RX..... | 13 |
| MNG10-10FBX..... | 27 | MNG10BCMKA..... | 41 | MNG14-47PK-A..... | 67 |
| MNG10-10FFBK..... | 32 | MNG10BCMXA..... | 41 | MNG14-47PX-A..... | 67 |
| MNG10-10FFBX..... | 32 | MNG10BCX..... | 41 | MNG14-4FB/SK..... | 27 |
| MNG10-10FK..... | 23 | MNG14-10FBK..... | 27 | MNG14-4FLX..... | 35 |
| MNG10-10FLK..... | 36 | MNG14-10FBX..... | 27 | MNG14-4R/SX..... | 13 |
| MNG10-10FLX..... | 36 | MNG14-10FFBK..... | 32 | MNG14-516R/SK..... | 13 |
| MNG10-10FX..... | 23 | MNG14-10FFBX..... | 32 | MNG14-516R/SX..... | 13 |
| MNG10-10RK..... | 14 | MNG14-10FK..... | 23 | MNG14-610RX..... | 21 |
| MNG10-10RX..... | 14 | MNG14-10FLK..... | 35 | MNG14-6FB/SK..... | 27 |
| MNG10-14FLK..... | 36 | MNG14-10FLX..... | 35 | MNG14-6FB/SX..... | 27 |
| MNG10-14FLX..... | 36 | MNG14-10FX..... | 23 | MNG14-6FBK..... | 27 |
| MNG10-14R/SK..... | 14 | MNG14-10R/LK..... | 13 | MNG14-6FBX..... | 27 |
| MNG10-14R/SX..... | 14 | MNG14-10R/LX..... | 13 | MNG14-6FFB/SX..... | 32 |
| MNG10-250DMIK..... | 57 | MNG14-10RK..... | 13 | MNG14-6FFBK..... | 32 |
| MNG10-250DMIX..... | 57 | MNG14-10RX..... | 13 | MNG14-6FLK..... | 35 |
| MNG10-250DMK..... | 58 | MNG14-110DFK-A..... | 51 | MNG14-6FLX..... | 35 |
| MNG10-250DMX..... | 58 | MNG14-14FLX..... | 35 | MNG14-6FX..... | 23 |
| MNG10-375DFK..... | 51 | MNG14-14R/SK..... | 13 | MNG14-6R/SK..... | 13 |
| MNG10-38R/SK..... | 14 | MNG14-14R/SX..... | 13 | MNG14-6R/SX..... | 13 |
| MNG10-38R/SX..... | 14 | MNG14-156DFIK-A..... | 50 | MNG14-8FBK..... | 27 |
| MNG10-4R/SK..... | 13 | MNG14-156DFIX-A..... | 50 | MNG14-8FBX..... | 27 |
| MNG10-516R/SK..... | 14 | MNG14-156DMKA..... | 58 | MNG14-8FFBK..... | 32 |
| MNG10-516R/SX..... | 14 | MNG14-156DMXA..... | 58 | MNG14-8FFBX..... | 32 |
| MNG10-55PK-A..... | 67 | MNG14-180DFIK-A..... | 50 | MNG14-8FK..... | 23 |
| MNG10-55PX-A..... | 67 | MNG14-180DFIX-A..... | 50 | MNG14-8FLK..... | 35 |
| MNG10-610RX..... | 21 | MNG14-187DFIK..... | 48 | MNG14-8FLX..... | 35 |
| MNG10-6FBK..... | 27 | MNG14-187DFIX..... | 48 | MNG14-8FX..... | 23 |
| MNG10-6FBX..... | 27 | MNG14-187DFK..... | 51 | MNG14-8R/LK..... | 13 |
| MNG10-6FFBK..... | 32 | MNG14-187DFX..... | 51 | MNG14-8R/LX..... | 13 |
| MNG10-6FLK..... | 35 | MNG14-187DMIK..... | 56 | MNG14-8R/SK..... | 13 |
| MNG10-6FLX..... | 35 | MNG14-187DMIX..... | 56 | MNG14-8R/SX..... | 13 |
| MNG10-6FX..... | 23 | MNG14-187DMK..... | 58 | MNG14-8RK..... | 13 |
| MNG10-6RK..... | 13 | MNG14-187DMX..... | 58 | MNG14-8RX..... | 13 |
| MNG10-6RX..... | 14 | MNG14-250DFIK..... | 48 | MNG14BCK..... | 41 |
| MNG10-8FBK..... | 27 | MNG14-250DFIX..... | 48 | MNG14BCMKA..... | 41 |
| MNG10-8FBX..... | 27 | MNG14-250DFK..... | 51 | MNG14BCMXA..... | 41 |
| MNG10-8FFBK..... | 32 | MNG14-250DFX..... | 51 | MNG14BCX..... | 41 |
| MNG10-8FFBX..... | 32 | MNG14-250DMFK-A..... | 61 | MNG18-10FBK..... | 27 |
| MNG10-8FK..... | 23 | MNG14-250DMFX-A..... | 61 | MNG18-10FBX..... | 27 |
| MNG10-8FLK..... | 36 | MNG14-250DMIK..... | 57 | MNG18-10FFBK..... | 32 |

Index by Product Number

| Product Number | Page | Product Number | Page | Product Number | Page |
|-----------------|------|----------------|------|----------------|------|
| MNG18-10FFBX | 32 | MNG18-6FLX | 35 | MNI18-250DFIK | 47 |
| MNG18-10FLK | 35 | MNG18-6FX | 23 | MNI18-250DFIX | 47 |
| MNG18-10FLX | 35 | MNG18-6R/SK | 13 | MNU10-250DFIX | 49 |
| MNG18-10FX | 23 | MNG18-6R/SX | 13 | MNU10-250DMIK | 57 |
| MNG18-10R/LK | 13 | MNG18-8FBK | 27 | MNU10-250DMIX | 57 |
| MNG18-10R/LX | 13 | MNG18-8FBX | 27 | MNU14-187DFIK | 49 |
| MNG18-110DFK-A | 51 | MNG18-8FFBK | 32 | MNU14-187DFIX | 49 |
| MNG18-14R/SK | 13 | MNG18-8FFBX | 32 | MNU14-187DMIK | 57 |
| MNG18-14R/SX | 13 | MNG18-8FLK | 35 | MNU14-187DMIX | 57 |
| MNG18-156DFIK-A | 50 | MNG18-8FLX | 35 | MNU14-250DFIK | 49 |
| MNG18-156DMK-A | 58 | MNG18-8FX | 23 | MNU14-250DFIX | 49 |
| MNG18-180DFIK-A | 50 | MNG18-8R/LK | 13 | MNU14-250DMIK | 57 |
| MNG18-180DMK-A | 58 | MNG18-8R/LX | 13 | MNU14-250DMIX | 57 |
| MNG18-187DFIK | 48 | MNG18BCK | 41 | MNU18-187DFIK | 49 |
| MNG18-187DFIX | 48 | MNG18BCMKA | 41 | MNU18-187DFIX | 49 |
| MNG18-187DFK | 51 | MNG18BCMXA | 41 | MNU18-187DMIK | 57 |
| MNG18-187DMIK | 56 | MNG18BCX | 41 | MNU18-187DMIX | 57 |
| MNG18-187DMIX | 56 | MNGI10-250DFIK | 46 | MNU18-250DFIK | 49 |
| MNG18-187DMK | 58 | MNGI10-250DFIX | 46 | MNU18-250DFIX | 49 |
| MNG18-250DFIK | 48 | MNGI10-250DFK | 50 | MNU18-250DMIK | 57 |
| MNG18-250DFIX | 48 | MNGI10-250DFX | 50 | MNU18-250DMIX | 57 |
| MNG18-250DFK | 51 | MNGI14-250DFIK | 46 | MTI10-250Q | 77 |
| MNG18-250DFX | 51 | MNGI14-250DFIX | 46 | MTI14-187Q | 77 |
| MNG18-250DMFX-A | 61 | MNGI14-250DFK | 50 | MTI14-250Q | 77 |
| MNG18-250DMIK | 56 | MNGI14-250DFX | 50 | MTI18-187Q | 77 |
| MNG18-250DMIX | 56 | MNGI18-250DFIK | 46 | MTI18-250Q | 77 |
| MNG18-250DMK | 58 | MNGI18-250DFIX | 46 | MTV10-250Q | 77 |
| MNG18-250DMX | 58 | MNGI18-250DFK | 50 | MTV14-187Q | 77 |
| MNG18-38RK | 13 | MNGI18-250DFX | 50 | MTV14-250Q | 77 |
| MNG18-38RX | 13 | MNHU10-250DFIK | 45 | MTV18-187Q | 77 |
| MNG18-47PX-A | 67 | MNHU10-250DFIX | 45 | MTV18-250Q | 77 |
| MNG18-4FB/SK | 27 | MNHU10-250DMIK | 56 | MU10-10FBK | 31 |
| MNG18-4FLK | 35 | MNHU10-250DMIX | 56 | MU10-10FHTK | 64 |
| MNG18-4FLX | 35 | MNHU14-250DFIK | 45 | MU10-10FK | 26 |
| MNG18-4R/SK | 13 | MNHU14-250DFIX | 45 | MU10-10FLK | 39 |
| MNG18-4R/SX | 13 | MNHU14-250DMIK | 56 | MU10-10FLX | 39 |
| MNG18-516R/SX | 13 | MNHU14-250DMIX | 56 | MU10-10RHTK | 63 |
| MNG18-610RX | 21 | MNHU18-250DFIK | 45 | MU10-10RHTX | 63 |
| MNG18-6FB/SK | 27 | MNHU18-250DFIX | 45 | MU10-10RK | 20 |
| MNG18-6FB/SX | 27 | MNHU18-250DMIK | 56 | MU10-14FLK | 39 |
| MNG18-6FBK | 27 | MNHU18-250DMIX | 56 | MU10-14FLX | 39 |
| MNG18-6FBX | 27 | MNI10-250DFIK | 47 | MU10-14R/SK | 20 |
| MNG18-6FFB/SX | 32 | MNI10-250DFIX | 47 | MU10-14RHTK | 63 |
| MNG18-6FFBK | 32 | MNI14-250DFIK | 47 | MU10-250DMK | 60 |
| MNG18-6FLK | 35 | MNI14-250DFIX | 47 | MU10-250DMX | 60 |

Index by Product Number

| Product Number | Page | Product Number | Page | Product Number | Page |
|-------------------------|------|-----------------------|------|-----------------------|------|
| MU10-4R/SK..... | 20 | MU14-250DMHTX | 66 | MU18-47PX-A..... | 68 |
| MU10-55PX-A..... | 68 | MU14-250DMK..... | 60 | MU18-4FB/SK..... | 31 |
| MU10-6FBK..... | 31 | MU14-250DMX..... | 60 | MU18-4FLK..... | 39 |
| MU10-6RK..... | 20 | MU14-47PK-A..... | 68 | MU18-4R/SK..... | 20 |
| MU10-6RX..... | 20 | MU14-47PX-A..... | 68 | MU18-6FB/SK..... | 31 |
| MU10-8FBK..... | 31 | MU14-4FB/SK..... | 31 | MU18-6FBHTK..... | 64 |
| MU10-8FFBK..... | 34 | MU14-4R/SK..... | 20 | MU18-6FBK..... | 31 |
| MU10-8FLK..... | 39 | MU14-6FB/SK..... | 31 | MU18-6FFBK..... | 34 |
| MU10-8FLX..... | 39 | MU14-6FBHTK..... | 64 | MU18-6FK..... | 26 |
| MU10-8RK..... | 20 | MU14-6FLK..... | 39 | MU18-6FLK..... | 39 |
| MU10-8RX..... | 20 | MU14-6FLX..... | 39 | MU18-6FLX..... | 39 |
| MU10BCHTK..... | 65 | MU14-6R/SK..... | 20 | MU18-6R/SK..... | 20 |
| MU10BCHTX..... | 65 | MU14-6RHT/SK..... | 63 | MU18-6RHT/SX..... | 63 |
| MU10BCX..... | 45 | MU14-6RHT/SX..... | 63 | MU18-8FBK..... | 31 |
| MU14-10FBK..... | 31 | MU14-8FBK..... | 31 | MU18-8FLK..... | 39 |
| MU14-10FHTK..... | 64 | MU14-8FFBK..... | 34 | MU18-8FLX..... | 39 |
| MU14-10FK..... | 26 | MU14-8FLK..... | 39 | MU18-8R/LK..... | 20 |
| MU14-10FLK..... | 39 | MU14-8FLX..... | 39 | MU18-8RLX..... | 20 |
| MU14-10FLX..... | 39 | MU14-8R/LK..... | 20 | MU18BCHTK..... | 65 |
| MU14-10R/LK..... | 20 | MU14-8RLX..... | 20 | MU18BCHTX..... | 65 |
| MU14-10RHTK..... | 63 | MU14BCHTK..... | 65 | MU18BCX..... | 45 |
| MU14-10RHTX..... | 63 | MU14BCHTX..... | 65 | MU20-110/32DFK-A..... | 54 |
| MU14-10RK..... | 20 | MU14BCX..... | 45 | MU4-38RHTK..... | 63 |
| MU14-10RX..... | 20 | MU18-10FBK..... | 31 | MU6-38RHTK..... | 63 |
| MU14-110DFK..... | 54 | MU18-10FHTK..... | 64 | MU8-14RHT/SK..... | 63 |
| MU14-110DFX..... | 54 | MU18-10FLK..... | 39 | MV10-10FBK..... | 28 |
| MU14-14FLK..... | 39 | MU18-10FLX..... | 39 | MV10-10FBX..... | 28 |
| MU14-14R/SK..... | 20 | MU18-10R/LK..... | 20 | MV10-10FK..... | 24 |
| MU14-14RHTK..... | 63 | MU18-10RHTK..... | 63 | MV10-10FLK..... | 36 |
| MU14-14RHTX..... | 63 | MU18-10RHTX..... | 63 | MV10-10FLX..... | 36 |
| MU14-187DF/FLAGK..... | 55 | MU18-10RX..... | 20 | MV10-10FX..... | 24 |
| MU14-187DF/FLAGX..... | 55 | MU18-14R/SK..... | 20 | MV10-10RK..... | 16 |
| MU14-187DFHTK..... | 65 | MU18-187DF/FLAGK..... | 55 | MV10-10RX..... | 16 |
| MU14-187DFK..... | 54 | MU18-187DF/FLAGX..... | 55 | MV10-12RK..... | 16 |
| MU14-187DFX..... | 55 | MU18-187DFK..... | 54 | MV10-12RX..... | 16 |
| MU14-187DMK..... | 60 | MU18-187DFX..... | 54 | MV10-14FLK..... | 36 |
| MU14-187DMX..... | 60 | MU18-187DMK..... | 60 | MV10-14FLX..... | 36 |
| MU14-250DF/FLAGK..... | 55 | MU18-187DMX..... | 60 | MV10-14R/SK..... | 16 |
| MU14-250DF/FLAGX..... | 55 | MU18-250DF/FLAGK..... | 55 | MV10-14R/SX..... | 16 |
| MU14-250DFHT/FLAGK..... | 66 | MU18-250DF/FLAGX..... | 55 | MV10-38R/SK..... | 16 |
| MU14-250DFHTK..... | 65 | MU18-250DFK..... | 54 | MV10-38R/SX..... | 16 |
| MU14-250DFHTX..... | 65 | MU18-250DFX..... | 54 | MV10-4R/SK..... | 16 |
| MU14-250DFK..... | 55 | MU18-250DMK..... | 60 | MV10-516R/SK..... | 16 |
| MU14-250DFX..... | 55 | MU18-250DMX..... | 60 | MV10-516R/SX..... | 16 |
| MU14-250DMHTK..... | 66 | MU18-38RK..... | 20 | MV10-610RK..... | 21 |

Index by Product Number

| Product Number | Page | Product Number | Page | Product Number | Page |
|-----------------------|-------------|-----------------------|-------------|-----------------------|-------------|
| MV10-610RX..... | 21 | MV14-6FLK..... | 36 | MV18-8FK..... | 24 |
| MV10-6FBK..... | 28 | MV14-6FLX..... | 36 | MV18-8FLK..... | 36 |
| MV10-6FBX..... | 28 | MV14-6FX..... | 24 | MV18-8FLX..... | 36 |
| MV10-6FLK..... | 36 | MV14-6R/SK..... | 15 | MV18-8FX..... | 24 |
| MV10-6FLX..... | 36 | MV14-6R/SX..... | 15 | MV18-8R/LK..... | 15 |
| MV10-6FX..... | 24 | MV14-8FBK..... | 28 | MV18-8R/LX..... | 15 |
| MV10-6RK..... | 16 | MV14-8FBX..... | 28 | MV18BCK..... | 42 |
| MV10-6RX..... | 16 | MV14-8FK..... | 24 | MV18BCX..... | 42 |
| MV10-8FBK..... | 28 | MV14-8FLK..... | 36 | MV4BCK..... | 42 |
| MV10-8FBX..... | 28 | MV14-8FLX..... | 36 | MV4BCX..... | 42 |
| MV10-8FK..... | 24 | MV14-8FX..... | 24 | MV6BCK..... | 42 |
| MV10-8FLK..... | 36 | MV14-8R/LK..... | 15 | MV6BCX..... | 42 |
| MV10-8FLX..... | 36 | MV14-8R/LX..... | 15 | MV8BCK..... | 42 |
| MV10-8FX..... | 24 | MV14-8R/SK..... | 15 | MV8BCX..... | 42 |
| MV10-8RK..... | 16 | MV14BCK..... | 42 | MVG24-110/32DFX..... | 52 |
| MV10-8RX..... | 16 | MV14BCX..... | 42 | MVG24-110DFK..... | 52 |
| MV10BCK..... | 42 | MV18-10FBK..... | 28 | MVI10-250DFK..... | 52 |
| MV10BCX..... | 42 | MV18-10FBX..... | 28 | MVI10-250DFX..... | 52 |
| MV14-10FBK..... | 28 | MV18-10FLK..... | 36 | MVI14-250DFK..... | 52 |
| MV14-10FBX..... | 28 | MV18-10FLX..... | 36 | MVI14-250DFX..... | 52 |
| MV14-10FK..... | 24 | MV18-10FX..... | 24 | MVI18-250DFK..... | 52 |
| MV14-10FLK..... | 36 | MV18-10R/LK..... | 15 | MVI18-250DFX..... | 52 |
| MV14-10FLX..... | 36 | MV18-10R/LX..... | 15 | MVU10-10FBK..... | 29 |
| MV14-10FX..... | 24 | MV18-14R/SK..... | 15 | MVU10-10FBX..... | 29 |
| MV14-10R/LK..... | 15 | MV18-14R/SX..... | 15 | MVU10-10FFBK..... | 33 |
| MV14-10R/LX..... | 15 | MV18-38RX..... | 15 | MVU10-10FK..... | 25 |
| MV14-10RK..... | 15 | MV18-4FLK..... | 36 | MVU10-10FLK..... | 37 |
| MV14-14FLX..... | 36 | MV18-4FLX..... | 36 | MVU10-10FX..... | 25 |
| MV14-14R/SK..... | 15 | MV18-4R/SK..... | 15 | MVU10-10RK..... | 17 |
| MV14-14R/SX..... | 15 | MV18-4R/SX..... | 15 | MVU10-10RX..... | 17 |
| MV14-38RK..... | 16 | MV18-516R/SX..... | 15 | MVU10-14FLK..... | 37 |
| MV14-38RX..... | 16 | MV18-610RK..... | 21 | MVU10-14R/SK..... | 17 |
| MV14-4FB/SK..... | 28 | MV18-610RX..... | 21 | MVU10-14R/SX..... | 17 |
| MV14-4FLX..... | 36 | MV18-6FB/SK..... | 28 | MVU10-250DMK..... | 59 |
| MV14-4R/SK..... | 15 | MV18-6FB/SX..... | 28 | MVU10-250DMX..... | 59 |
| MV14-4R/SX..... | 15 | MV18-6FBK..... | 28 | MVU10-375DFK..... | 53 |
| MV14-516R/SK..... | 16 | MV18-6FBX..... | 28 | MVU10-38R/SK..... | 17 |
| MV14-516R/SX..... | 15 | MV18-6FK..... | 24 | MVU10-38R/SX..... | 17 |
| MV14-610RK..... | 21 | MV18-6FLK..... | 36 | MVU10-38RX..... | 17 |
| MV14-610RX..... | 21 | MV18-6FLX..... | 36 | MVU10-4R/SK..... | 17 |
| MV14-6FB/SK..... | 28 | MV18-6FX..... | 24 | MVU10-516R/SK..... | 17 |
| MV14-6FB/SX..... | 28 | MV18-6R/SK..... | 15 | MVU10-55PK-A..... | 67 |
| MV14-6FBK..... | 28 | MV18-6R/SX..... | 15 | MVU10-55PX-A..... | 67 |
| MV14-6FBX..... | 28 | MV18-8FBK..... | 28 | MVU10-6FBK..... | 29 |
| MV14-6FK..... | 24 | MV18-8FBX..... | 28 | MVU10-6FBX..... | 29 |

Index by Product Number

| Product Number | Page | Product Number | Page | Product Number | Page |
|-----------------|------|----------------|------|------------------|------|
| MVU10-6FFBK | 33 | MVU14-38R/SX | 17 | MVU18-187DFK | 53 |
| MVU10-6FK | 25 | MVU14-38RK | 17 | MVU18-187DFX | 53 |
| MVU10-6FLK | 37 | MVU14-47PK-A | 67 | MVU18-187DMK | 59 |
| MVU10-6FX | 25 | MVU14-47PX-A | 67 | MVU18-187DMX | 59 |
| MVU10-6RK | 17 | MVU14-4FB/SK | 29 | MVU18-250DFK | 53 |
| MVU10-6RX | 17 | MVU14-4FLK | 37 | MVU18-250DFX | 53 |
| MVU10-8FBK | 29 | MVU14-4R/SK | 17 | MVU18-250DMFK-A | 61 |
| MVU10-8FBX | 29 | MVU14-516R/SK | 17 | MVU18-250DMFX-A | 61 |
| MVU10-8FFBK | 33 | MVU14-6FB/SK | 29 | MVU18-250DMK | 59 |
| MVU10-8FK | 25 | MVU14-6FB/SX | 29 | MVU18-250DMX | 59 |
| MVU10-8FLK | 37 | MVU14-6FBK | 29 | MVU18-38RK | 16 |
| MVU10-8FX | 25 | MVU14-6FBX | 29 | MVU18-47PK-A | 67 |
| MVU10-8R/SX | 17 | MVU14-6FFBK | 33 | MVU18-47PX-A | 67 |
| MVU10-8RK | 17 | MVU14-6FK | 25 | MVU18-4FB/SK | 29 |
| MVU10-8RX | 17 | MVU14-6FLK | 37 | MVU18-4FLK | 37 |
| MVU10BCK | 43 | MVU14-6FX | 25 | MVU18-4R/SK | 16 |
| MVU10BCX | 43 | MVU14-6R/SK | 17 | MVU18-516R/SK | 16 |
| MVU10PCK | 70 | MVU14-6R/SX | 17 | MVU18-6FB/SK | 29 |
| MVU14-10FBK | 29 | MVU14-8FBK | 29 | MVU18-6FBK | 29 |
| MVU14-10FBX | 29 | MVU14-8FBX | 29 | MVU18-6FBX | 29 |
| MVU14-10FFBK | 33 | MVU14-8FFBK | 33 | MVU18-6FFBK | 33 |
| MVU14-10FK | 25 | MVU14-8FK | 25 | MVU18-6FK | 25 |
| MVU14-10FLK | 37 | MVU14-8FLK | 37 | MVU18-6FLK | 37 |
| MVU14-10FX | 25 | MVU14-8FX | 25 | MVU18-6FX | 25 |
| MVU14-10R/LK | 17 | MVU14-8R/LK | 17 | MVU18-6R/SK | 16 |
| MVU14-10RK | 17 | MVU14-8R/SK | 17 | MVU18-6R/SX | 16 |
| MVU14-10RX | 17 | MVU14-8R/SX | 17 | MVU18-8FBK | 29 |
| MVU14-110DFK-A | 53 | MVU14-8RK | 17 | MVU18-8FBX | 29 |
| MVU14-14FLK | 37 | MVU14-8RX | 17 | MVU18-8FFBK | 33 |
| MVU14-14R/SK | 17 | MVU14BCK | 43 | MVU18-8FK | 25 |
| MVU14-14R/SX | 17 | MVU14BCX | 43 | MVU18-8FLK | 37 |
| MVU14-156DMK-A | 59 | MVU14PCK | 70 | MVU18-8FX | 25 |
| MVU14-156DMX-A | 59 | MVU18-10FBK | 29 | MVU18-8R/LK | 16 |
| MVU14-180DMK-A | 59 | MVU18-10FBX | 29 | MVU18-8R/LX | 16 |
| MVU14-180DMX-A | 59 | MVU18-10FFBK | 33 | MVU18-8R/SX | 16 |
| MVU14-187DFK | 53 | MVU18-10FK | 25 | MVU18BCK | 43 |
| MVU14-187DFX | 53 | MVU18-10FLK | 37 | MVU18BCX | 43 |
| MVU14-187DMK | 59 | MVU18-10FX | 25 | MVU18PCK | 70 |
| MVU14-187DMX | 59 | MVU18-10R/LK | 16 | RED-TERMINAL-BOX | 78 |
| MVU14-250DFK | 53 | MVU18-10R/LX | 16 | RV10-10Q | 72 |
| MVU14-250DFX | 53 | MVU18-10RX | 16 | RV10-14Q | 72 |
| MVU14-250DMFK-A | 61 | MVU18-14R/SK | 16 | RV10-38Q | 72 |
| MVU14-250DMFX-A | 61 | MVU18-14R/SX | 16 | RV10-516Q | 72 |
| MVU14-250DMK | 59 | MVU18-156DMK-A | 59 | RV10-6Q | 72 |
| MVU14-250DMX | 59 | MVU18-180DMK-A | 59 | RV10-8Q | 72 |

Index by Product Number

| Product Number | Page |
|-----------------------|-------------|
| RV14-10Q..... | 72 |
| RV14-14Q..... | 72 |
| RV14-516Q..... | 72 |
| RV14-6Q..... | 72 |
| RV14-8Q..... | 72 |
| RV18-10Q..... | 72 |
| RV18-14Q..... | 72 |
| RV18-6Q..... | 72 |
| RV18-8Q..... | 72 |
| STK-1..... | 78 |
| TH-440..... | 79 |
| TH-450..... | 79 |
| TR-482..... | 79 |
| TR-490..... | 79 |

3M, Scotchlok, Highland and Scotchcode are trademarks of 3M Company.

The images, pictures, and illustrations found in this catalog are for illustration purposes only. Check the Product Technical Data Sheets for actual product details.

3M products listed in this publication that are associated with a U.S.A. flag are manufactured in the USA as of the date of publication. 3M products offered on a government contract that require country of origin representation must be certified by 3M's Trade Compliance Department (contact your customer service support team to request a certification).

"RoHS 2011/65/EU" means that the product or part does not contain any of the substances in excess of the maximum concentration values ("MCVs") in EU RoHS Directive 2011/65/EU. The MCVs are by weight in homogeneous materials. This information represents 3M's knowledge and belief, which may be based in whole or in part on information provided by third party suppliers to 3M.

Important Notice

Before using this product, you must evaluate it and determine if it is suitable for your intended application. You assume all risks and liability associated with such use.

Warranty; Limited Remedy; Limited Liability.

3M's product warranty is stated in its Product Literature available upon request. **3M MAKES NO OTHER WARRANTIES INCLUDING, BUT NOT LIMITED TO, ANY IMPLIED WARRANTY OF MERCHANTABILITY OR FITNESS FOR A PARTICULAR PURPOSE.** If this product is defective within the warranty period stated above, your exclusive remedy shall be, at 3M's option, to replace or repair the 3M product or refund the purchase price of the 3M product. **Except where prohibited by law, 3M will not be liable for any indirect, special, incidental or consequential loss or damage arising from this 3M product, regardless of the legal theory asserted.**



Electrical Markets Division

6801 River Place Blvd.
Austin, TX 78726-9000
800/245 3573
Fax 800/245 0329
www.3M.com/electrical

Please recycle. Printed in USA.
© 3M 2013. All rights reserved.
80-6016-0536-5 (08115.0) GP-2

Компания «Океан Электроники» предлагает заключение долгосрочных отношений при поставках импортных электронных компонентов на взаимовыгодных условиях!

Наши преимущества:

- Поставка оригинальных импортных электронных компонентов напрямую с производств Америки, Европы и Азии, а так же с крупнейших складов мира;
- Широкая линейка поставок активных и пассивных импортных электронных компонентов (более 30 млн. наименований);
- Поставка сложных, дефицитных, либо снятых с производства позиций;
- Оперативные сроки поставки под заказ (от 5 рабочих дней);
- Экспресс доставка в любую точку России;
- Помощь Конструкторского Отдела и консультации квалифицированных инженеров;
- Техническая поддержка проекта, помощь в подборе аналогов, поставка прототипов;
- Поставка электронных компонентов под контролем ВП;
- Система менеджмента качества сертифицирована по Международному стандарту ISO 9001;
- При необходимости вся продукция военного и аэрокосмического назначения проходит испытания и сертификацию в лаборатории (по согласованию с заказчиком);
- Поставка специализированных компонентов военного и аэрокосмического уровня качества (Xilinx, Altera, Analog Devices, Intersil, Interpoint, Microsemi, Actel, Aeroflex, Peregrine, VPT, Syfer, Eurofarad, Texas Instruments, MS Kennedy, Miteq, Cobham, E2V, MA-COM, Hittite, Mini-Circuits, General Dynamics и др.);

Компания «Океан Электроники» является официальным дистрибьютором и эксклюзивным представителем в России одного из крупнейших производителей разъемов военного и аэрокосмического назначения «JONHON», а так же официальным дистрибьютором и эксклюзивным представителем в России производителя высокотехнологичных и надежных решений для передачи СВЧ сигналов «FORSTAR».



JONHON

«JONHON» (основан в 1970 г.)

Разъемы специального, военного и аэрокосмического назначения:

(Применяются в военной, авиационной, аэрокосмической, морской, железнодорожной, горно- и нефтедобывающей отраслях промышленности)

«FORSTAR» (основан в 1998 г.)

ВЧ соединители, коаксиальные кабели,
кабельные сборки и микроволновые компоненты:

(Применяются в телекоммуникациях гражданского и специального назначения, в средствах связи, РЛС, а так же военной, авиационной и аэрокосмической отраслях промышленности).



Телефон: 8 (812) 309-75-97 (многоканальный)

Факс: 8 (812) 320-03-32

Электронная почта: ocean@oceanchips.ru

Web: <http://oceanchips.ru/>

Адрес: 198099, г. Санкт-Петербург, ул. Калинина, д. 2, корп. 4, лит. А