

14 W 15 V 5 V SMPS demo board with ICE5AR4770AG

DEMO_5AR4770AG_14W1

About this document

Scope and purpose

This document is an engineering report that describes a universal-input 14 W 15 V 5 V off-line non-isolated Flyback converter using the latest fifth-generation Infineon Fixed Frequency (FF) CoolSET™ ICE5AR4770AG, which offers high-efficiency, low-standby power with selectable entry and exit standby power options, wide V_{CC} operating range with fast start-up, robust line protection with input Over Voltage Protection (OVP) and various protection modes for a highly reliable system. This demo board is designed for users who wish to evaluate ICE5AR4770AG in terms of optimized efficiency, thermal performance and EMI.

Intended audience

This document is intended for power supply design/application engineers, students, etc. who wish to design low-cost and highly reliable systems of off-line SMPS, either for auxiliary power supplies for white goods, PCs, servers and TVs, or enclosed adapters for Blu-ray players, set-top boxes, games consoles, etc.

Table of contents

About this document	1
Table of contents	1
1 Abstract.....	3
2 Demo board	4
3 Specification of the demo board.....	5
4 Circuit description	6
4.1 Line input.....	6
4.2 Start-up.....	6
4.3 Integrated CoolMOS™ with frequency reduction control	6
4.4 Frequency jittering.....	7
4.5 RCD clamper circuit.....	7
4.6 Output stage.....	7
4.7 Feedback loop	7
4.8 Active Burst Mode (ABM)	7
5 Protection features	8
6 Circuit diagram	9
7 PCB layout	10
7.1 Top side	10
7.2 Bottom side	10
8 Bill of Materials (BOM).....	11
9 Transformer construction.....	12
10 Test results	13
10.1 Efficiency, regulation and output ripple.....	13



Abstract

10.2 Efficiency..... 14

10.3 Standby power 14

10.4 Line regulation 15

10.5 Load regulation 15

10.6 Maximum input power 16

10.7 Frequency reduction 16

10.8 Surge immunity (EN 61000-4-5) 17

10.9 Conducted emissions (EN 55022 class B) 17

10.10 Thermal measurements..... 20

11 Waveforms and oscilloscope plots.....21

11.1 Start-up at full load 21

11.2 Soft-start at full load 21

11.3 Drain and CS voltage at full load 22

11.4 Frequency jittering at full load..... 22

11.5 Load transient response (dynamic load from 10% to 100%) 23

11.6 Output ripple voltage at full load 23

11.7 Output ripple voltage at ABM (0.5 W load) 24

11.8 Entering ABM 24

11.9 During ABM 25

11.10 Leaving ABM 25

11.11 Line OVP (non-switch auto restart)..... 26

11.12 V_{CC} OV/UV protection 26

11.13 Over-load protection..... 27

11.14 V_{CC} short-to-GND..... 27

12 References28

Revision history28

Abstract

1 Abstract

This document is an engineering report for a 14 W 15 V 5 V demo board designed in an FF non-isolated Flyback converter topology with primary-side feedback (FB) using the fifth-generation FF CoolSET™ ICE5AR4770AG. The demo board is operated in Discontinuous Conduction Mode (DCM) and is running at 100 kHz fixed switching frequency. The frequency reduction with soft gate driving and frequency jittering offers lower EMI and better efficiency between light load and 50% load. The selectable Active Burst Mode (ABM) power enables ultra-low power consumption. In addition, numerous adjustable protection functions have been implemented in ICE5AR4770AG to protect the system and customize the IC for the chosen application. In case of failure modes such as line OV, V_{CC} OV/Under Voltage (UV), open control-loop or over-load, over-temperature, V_{CC} short-to-GND and CS short-to-GND, the device enters protection mode. By means of the cycle-by-cycle Peak Current Limitation (PCL), the dimensions of the transformer and the current rating of the secondary diode can both be optimized. In this way, a cost-effective solution can easily be achieved. The target applications of ICE5AR4770AG are either auxiliary power supplies for white goods, PCs, servers and TVs, or enclosed adapters for Blu-ray players, set-top boxes, games consoles, etc.

Demo board

2 Demo board

This document contains the list of features, the power supply specifications, schematics, Bill of Materials (BOM) and the transformer construction documentation. Typical operating characteristics such as performance curve and scope waveforms are shown at the end of the report.

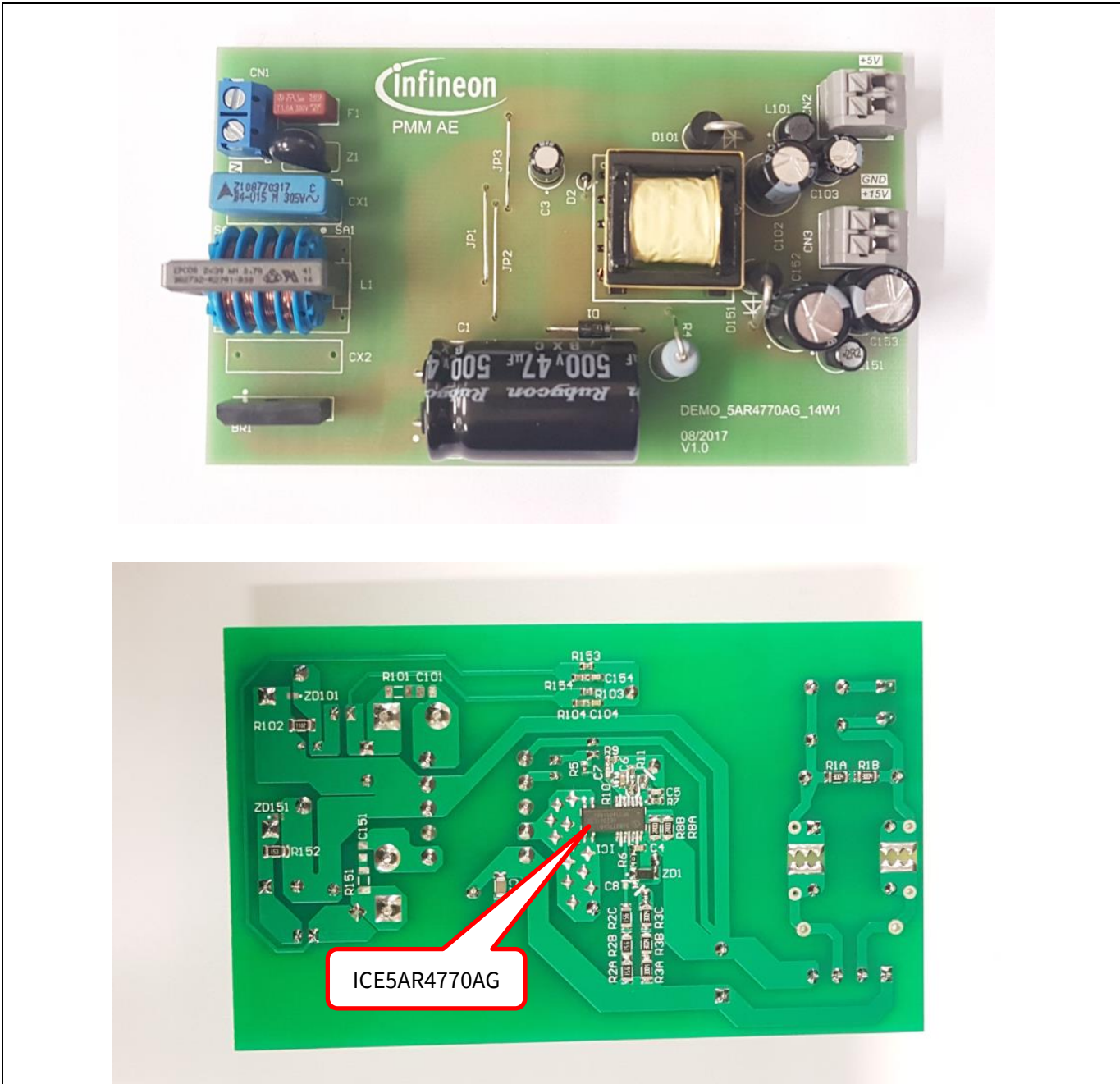

Figure 1 DEMO_5AR4770AG_14W1

3 Specification of the demo board

Table 1

Input voltage and frequency	85 V AC (60 Hz) ~ 300 V AC (50 Hz)
Output voltage, current and power	$(15 \text{ V} \times 0.83 \text{ A}) + (5 \text{ V} \times 0.40 \text{ A}) = 14.45 \text{ W}$
Regulation	+5 V: less than $\pm 5\%$ +15 V: less than $\pm 15\%$
Output ripple voltage (full load, 85 V AC ~ 300 V AC)	5 V _{ripple_p_p} < 100 mV 15 V _{ripple_p_p} < 200 mV
Active mode four-point average efficiency (25%, 50%, 75%, 100% load)	> 83% at 115 V AC and 230 V AC
Standby power consumption	No load: P _{IN} < 100 mW at 230 V AC 60 mW load: P _{IN} < 170 mW at 230 V AC
Conducted emissions (EN 55022 class B)	Pass with 6.3 dB margin for 115 V AC and 8.4 dB margin for 230 V AC
Surge immunity (EN 61000-4-5)	Installation class 4 (± 2 kV for line-to-line)
Form factor case size (L × W × H)	(110 × 66 × 27) mm ³

Note: “The demo board is designed for dual-output with cross-regulated loop FB. It may not regulate properly if loading is applied only to single-output. If the user wants to evaluate for single-output (15 V only) conditions, the following changes are necessary on the board.

1. Remove D101, L101, C102, C103, R102, R103, R104 and C104 (to disable 5 V output).
2. Change R11 to 30 k Ω and R153 to 220 k Ω (full regulation FB at 15 V output).

“Since the board (especially the transformer) is designed for dual-output with optimized cross-regulation, single-output efficiency might not be optimized. It is only for IC functional evaluation under single-output conditions.”

Circuit description

4 Circuit description

4.1 Line input

The AC-line input side comprises the input fuse F1 as Over Current Protection (OCP). The choke L1 and X-capacitor CX1 act as EMI suppressors. Optional spark-gap devices SA1, SA2 and varistor Z1 can absorb HV stress during a lightning surge test. A rectified DC voltage (120 ~ 424 V DC) is obtained through the bridge rectifier BR1 together with bulk capacitor C1.

4.2 Start-up

To achieve fast and safe start-up, ICE5AR4770AG has been implemented with start-up resistor and V_{CC} short-to-GND protection. When V_{VCC} reaches the turn-on voltage threshold of 16 V, the IC begins with a soft-start. The soft-start implemented in ICE5AR4770AG is a digital time-based function. The preset soft-start time is 12 ms with four steps. If not limited by other functions, the peak voltage on the CS pin will increase incrementally from 0.3 V to 0.8 V. After IC turn-on, the V_{CC} voltage is supplied by auxiliary windings of the transformer. V_{CC} short-to-GND protection is implemented during the start-up time.

4.3 Integrated CoolMOS™ with frequency reduction control

ICE5AR4770AG is comprised of a CoolMOS™ and the frequency reduction controller, which enables better efficiency between light load and 50% load. This integrated solution greatly simplifies the circuit layout and reduces the cost of PCB manufacturing. The new CoolSET™ can be operated in either DCM or Continuous Conduction Mode (CCM) with frequency reduction mode. This demo board is designed to operate in DCM. When the system is operating at maximum power, the controller will switch at the FF of 100 kHz. In order to achieve better efficiency between light load and medium load, frequency reduction is implemented and the reduction curve is shown in Figure 2. The V_{CS} is clamped by the current limitation threshold or by the PWM op-amp while the switching frequency is reduced. After the maximum frequency reduction, the minimum switching frequency is f_{OSC4_MIN} (43 kHz).

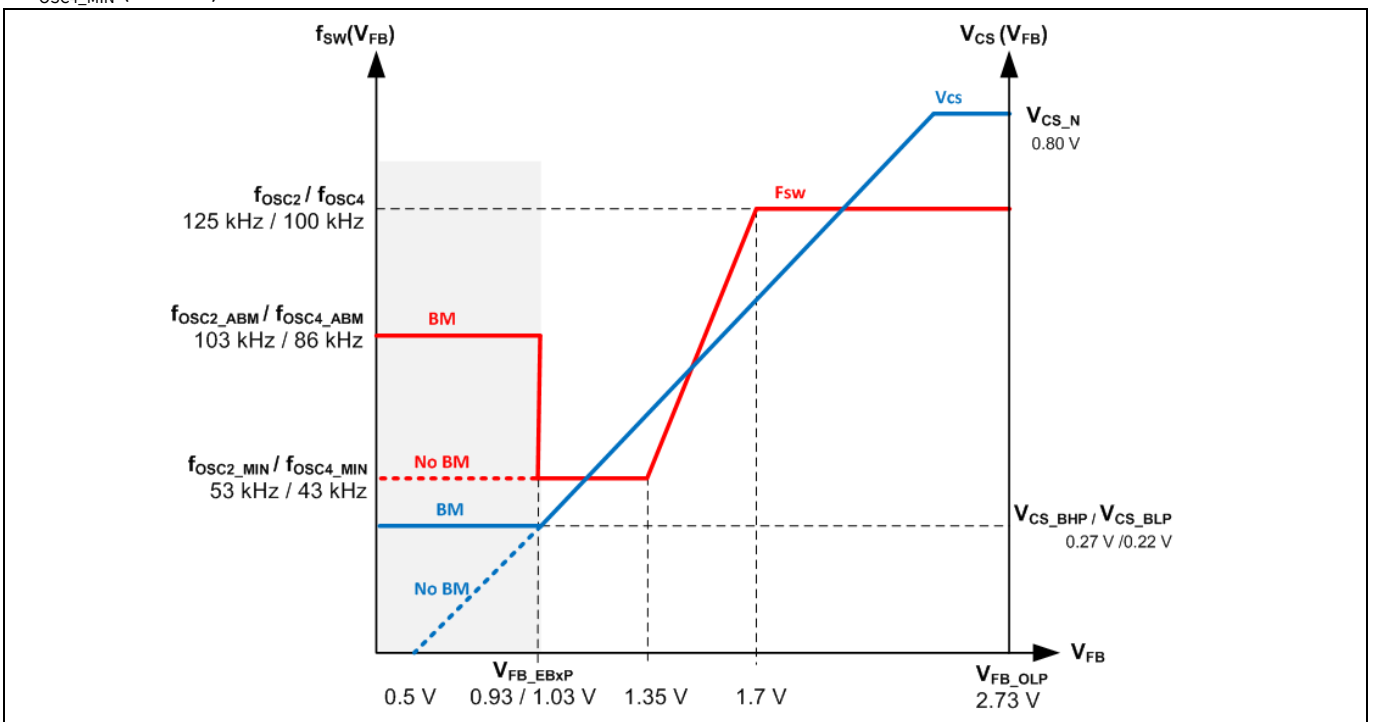

Figure 2 Frequency reduction curve

Circuit description

4.4 Frequency jittering

The ICE5AR4770AG has a frequency jittering feature to reduce the EMI noise. The jitter frequency is internally set at 100 kHz (± 4 kHz), and the jitter period is 4 ms.

4.5 RCD clamper circuit

A clamper network (R4, C2 and D1) dissipates the energy of the leakage inductance and suppresses ringing on the SMPS transformer.

4.6 Output stage

There are two outputs in this converter, 15 V and 5 V. The power is coupled out via Schottky diodes D151 and D101. The capacitors C152 and C102 provide energy buffering, followed by the L-C filters L151-C153 and L101-C103 to reduce the output voltage ripple and prevent interference between SMPS switching frequency and line frequency. Storage capacitors C152 and C102 are selected to have a very small internal resistance (ESR) to minimize the output voltage ripple.

4.7 Feedback loop

For FB, the output is sensed by the voltage divider of R11, R103 and R153 compared to the internal reference voltage of ICE5AR4770AG via the V_{ERR} pin, which is connected to the input of an integrated error amplifier internally. Connecting this pin enables non-isolated application. Feed-forward circuit R154, C154, R104 and C104 comprises the compensation network. The comparison voltage is converted to the current signal via an IC internal error amplifier to the FB pin for regulation control.

4.8 Active Burst Mode (ABM)

ABM entry and exit power (three levels) can be selected in ICE5AR4770AG. Details are illustrated in the product datasheet. Under light-load conditions, the SMPS enters ABM. At this stage, the controller is always active but the V_{VCC} must be kept above the switch-off threshold. During ABM, the efficiency increases significantly and at the same time it supports low ripple on V_{out} and fast response on load-jump.

In order to enter ABM operation, two conditions must apply:

1. The FB voltage must be lower than the threshold of V_{FB_EBXP} .
2. There must be a certain blanking time ($t_{FB_BEB} = 36$ ms).

Once both of these conditions are fulfilled, the ABM flip-flop is set and the controller enters ABM operation. This dual-condition determination for entering ABM operation prevents mis-triggering of ABM, so that the controller enters ABM operation only when the output power is really low during the preset blanking time.

During ABM, the maximum Current Sense (CS) voltage is reduced from V_{CS_N} to V_{CS_BXP} to reduce the conduction loss and the audible noise. In ABM, the FB voltage is changing like a sawtooth between $V_{FB_Bon_NISO}$ and $V_{FB_Boff_NISO}$.

The FB voltage immediately increases if there is a high load-jump. This is observed by one comparator. As the current limit is 27/33% during ABM a certain load is needed so that the FB voltage can exceed V_{FB_LB} (2.73 V).

After leaving ABM, maximum current can now be provided to stabilize V_{out} .

Protection features

5 Protection features

Protection is one of the major factors in determining whether the system is safe and robust. Therefore sufficient protection is necessary. ICE5AR4770AG provides comprehensive protection to ensure the system is operating safely. These protections include line OV, V_{CC} OV and UV, over-load, over-temperature (controller junction), CS short-to-GND and V_{CC} short-to-GND. When those faults are found, the system will enter protection mode until the fault is removed, when the system resumes normal operation. A list of protections and the failure conditions are shown in the table below.

Table 2 Protection functions of ICE5AR4770AG

Protection function	Failure condition	Protection mode
Line OV	$V_{VIN} > 2.85 \text{ V}$	Non-switch auto restart
V_{CC} OV	$V_{VCC} > 25.5 \text{ V}$	Odd-skip auto restart
V_{CC} UV	$V_{VCC} < 10 \text{ V}$	Auto restart
Over-load	$V_{FB} > 2.73 \text{ V}$ and lasts for 54 ms	Odd-skip auto restart
Over-temperature (junction temperature of controller chip only)	$T_J > 140^\circ\text{C}$	Non-switch auto restart
CS short-to-GND	$V_{CS} < 0.1 \text{ V}$, last for 0.4 μs and three consecutive pulses	Odd-skip auto restart
V_{CC} short-to-GND ($V_{VCC} = 0 \text{ V}$, $R_{\text{Start-up}} = 50 \text{ M}\Omega$ and $V_{\text{DRAIN}} = 90 \text{ V}$)	$V_{VCC} < 1.2 \text{ V}$, $I_{VCC_Charge1} \approx -0.27 \text{ mA}$	Cannot start up

6 Circuit diagram

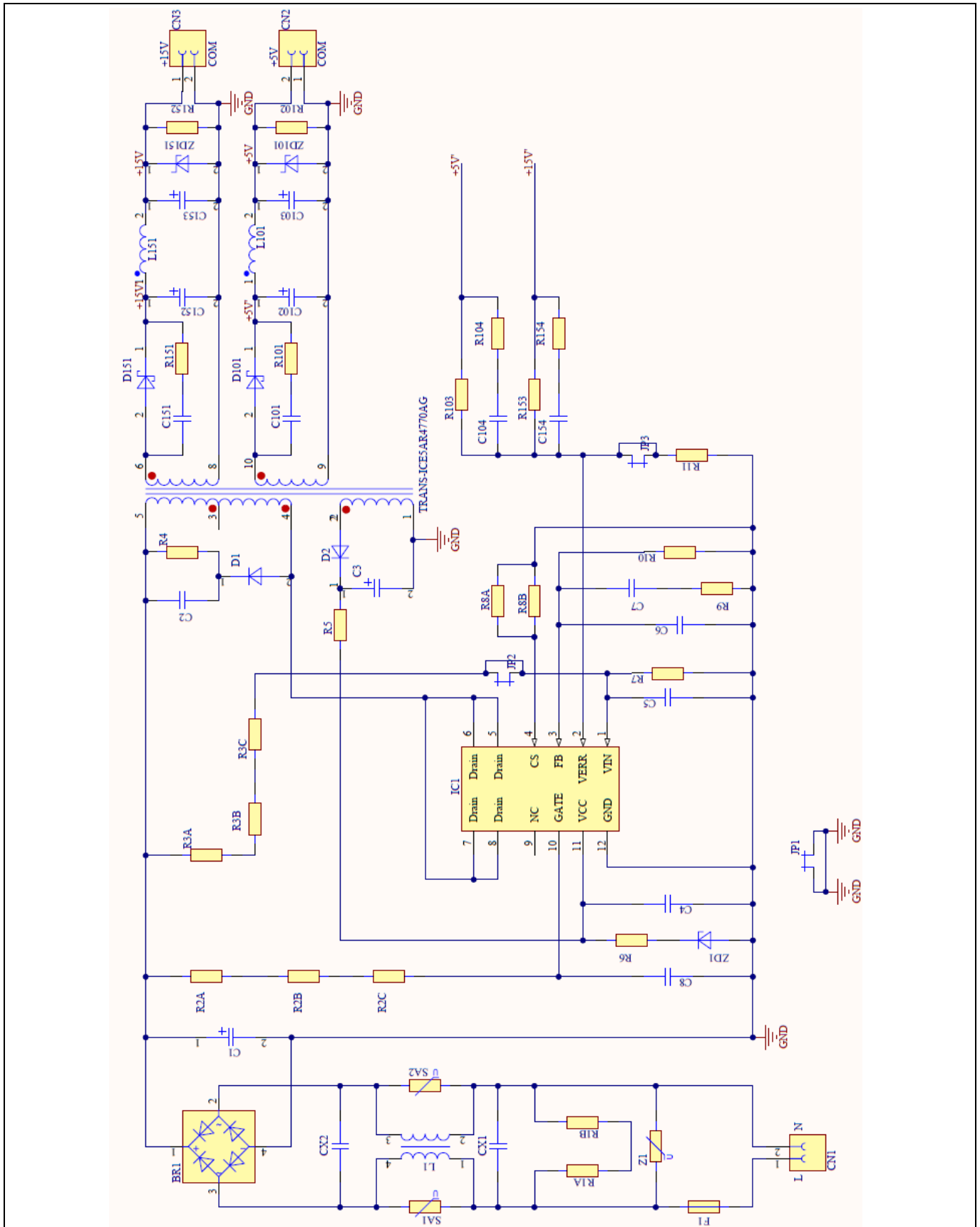

Figure 3 Schematic of DEMO_5AR4770AG_14W1

PCB layout

7 PCB layout

7.1 Top side

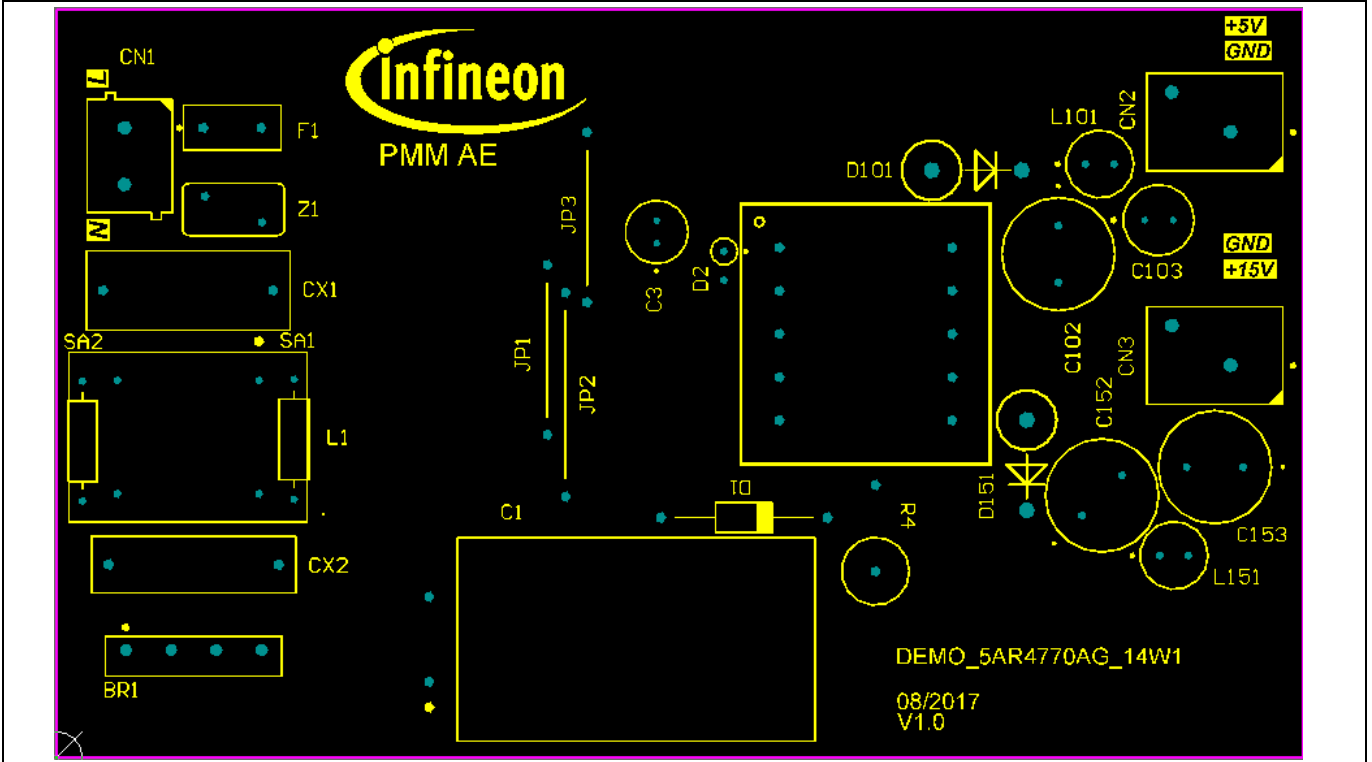

Figure 4 Top side component legend

7.2 Bottom side

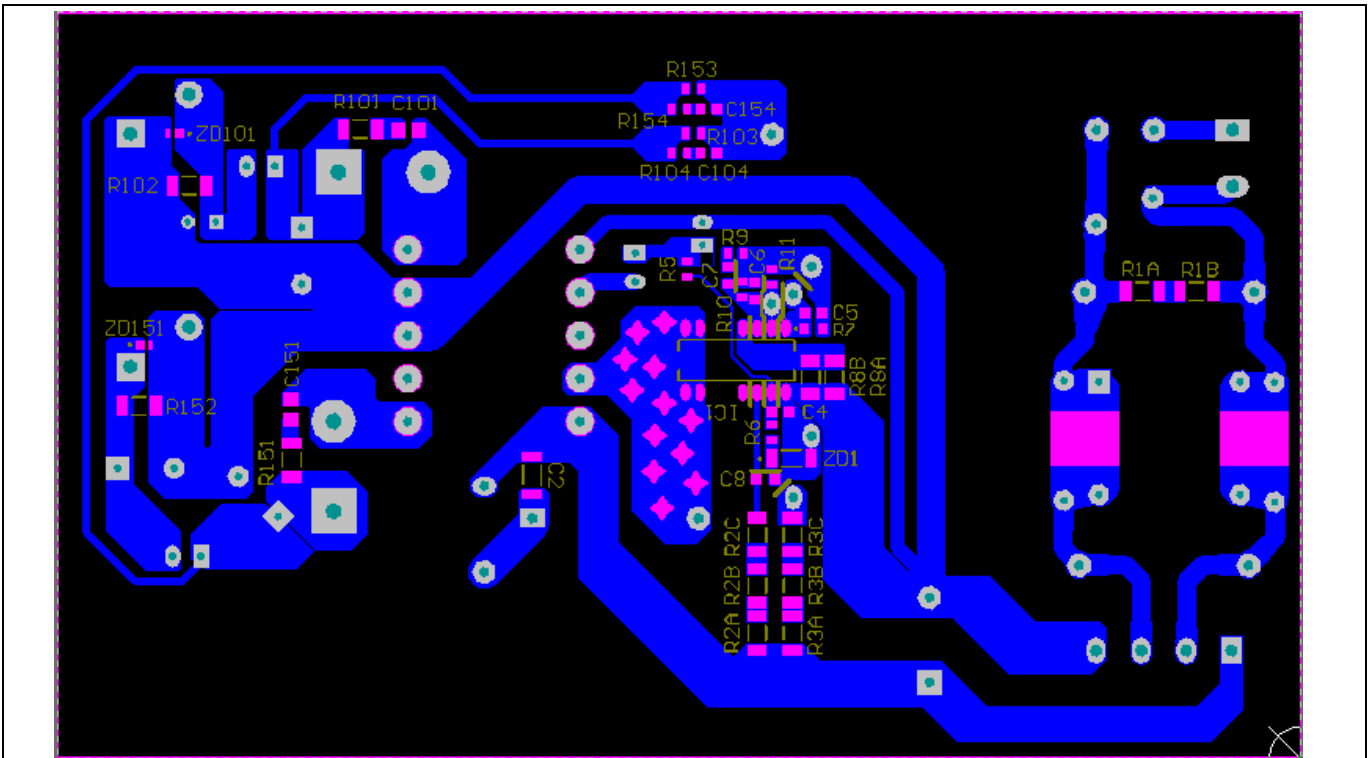

Figure 5 Bottom side copper and component legend

Bill of Materials (BOM)

8 Bill of Materials (BOM)

Table 3 BOM

No.	Designator	Description	Part number	Manufacturer	Quantity
1	F1	1.6 A/300 V	36911600000	Littlefuse	1
2	Z1	Varistor, 0.3 W/320 V	ERZE07A511	Panasonic	1
3	BR1	600 V/1 A	S1VBA60	Shindengen	1
4	CX1	0.15 μ F, X-cap	B32922C3154M000	EPCOS / TDK	1
5	C1	47 μ F/500 V	500BXC47MEFC18X31.5	Rubycon	1
6	C2	1 nF/630 V (1206)	GRM31A7U2J102JW31D	Murata	1
7	C3	22 μ F/50 V	50PX22MEFC5X11	Rubycon	1
8	C4	0.1 μ F/50 V DC	GRM188R71H104KA93D	Murata	1
9	C5, C154	1000 pF/50 V DC	GRM1885C1H102GA01D	Murata	2
10	C6, C104	4700 pF/50 V DC	GRM188R71H472KA01D	Murata	2
11	C7	15 pF/50 V DC	GRM1885C1H150JA01D	Murata	1
12	C102	680 μ F/10 V DC	10ZL680MEFC8X16	RUBYCON	1
13	C103	330 μ F/10 V DC	10ZLH330MEFC6.3X11	RUBYCON	1
14	C152, C153	680 μ F/25 V DC	25ZLS680MEFC10X16	RUBYCON	2
15	ZD1	22 V/500 mW	BZS55B22 RXG		1
16	D1	1 A/ 800 V	UF4006-E3/54		1
17	D2	0.2 A/200 V	1N485B		1
18	D151	3 A/150 V	STPS3150		1
19	D101	3 A/60 V	MBR360		1
20	IC1	ICE5AR4770AG	ICE5AR4770AG	Infineon	1
21	L1	39 mH/0.7 A	B82732R2701B030	EPCOS / TDK	1
22	L101, L151	2.2 μ H/4.3 A	744 746 202 2	Würth Electronics	2
23	R1A, R1B	3 M Ω /0.25 W/5%/1206			2
24	R2A, R2B, R2C	15 M Ω /0.25 W/5%/1206	RC1206JR-0715ML	Yageo	3
25	R3A, R3B, R3C	3 M Ω /0.25 W/1%/1206	RC1206FR-073ML	Yageo	3
26	R4	68 k Ω /2 W/500 V	MO2CT631R683J	KOA Speer	1
27	R5	4.7 Ω /0.1 W/5%/0603			1
28	R6	0 Ω /0603			1
29	R7	56 k Ω /0.1 W/ \pm 1%/0603			1
30	R8A, R8B	2 Ω /0.25 W/ \pm 1%/1206	RC1206FR-072RL	Yageo	2
31	R9	260 k Ω /0.1 W/0603			1
32	R11	27 k Ω /0.1 W/1%/0603			1
33	R154	33 k Ω /0.1 W/1%/0603			1
34	R103	68 k Ω /0.1 W/1%/0603			1
35	R104	4.7 k Ω /0.1 W/1%/0603			1
36	R153	680 k Ω /0.1 W/1%/0603			1
37	R102	11 k Ω /0.25 W/5%/1206			1
38	R152	15 k Ω /0.25 W/5%/1206			1
39	T1	550 μ H, EE20_H	750343669	Würth Electronics	1
40	CN1	Connector	691102710002	Würth Electronics	1
41	CN2,CN3	Connector	691 412 120 002B	Würth Electronics	2
42	JP1-JP3	Jumper			3
43	PCB	110 mm \times 66 mm (LXW), single layer, 2 Oz., FR-4			1

9 Transformer construction

Core and materials: EE20/10/6, TP4A (TDG)

Bobbin: 070-4989 (10-pin, THT, horizontal version)

Primary inductance: $L_p = 550 \mu\text{H}$ ($\pm 10\%$), measured between pin 4 and pin 5

Manufacturer and part number: Wurth Electronics Midcom (750343669)

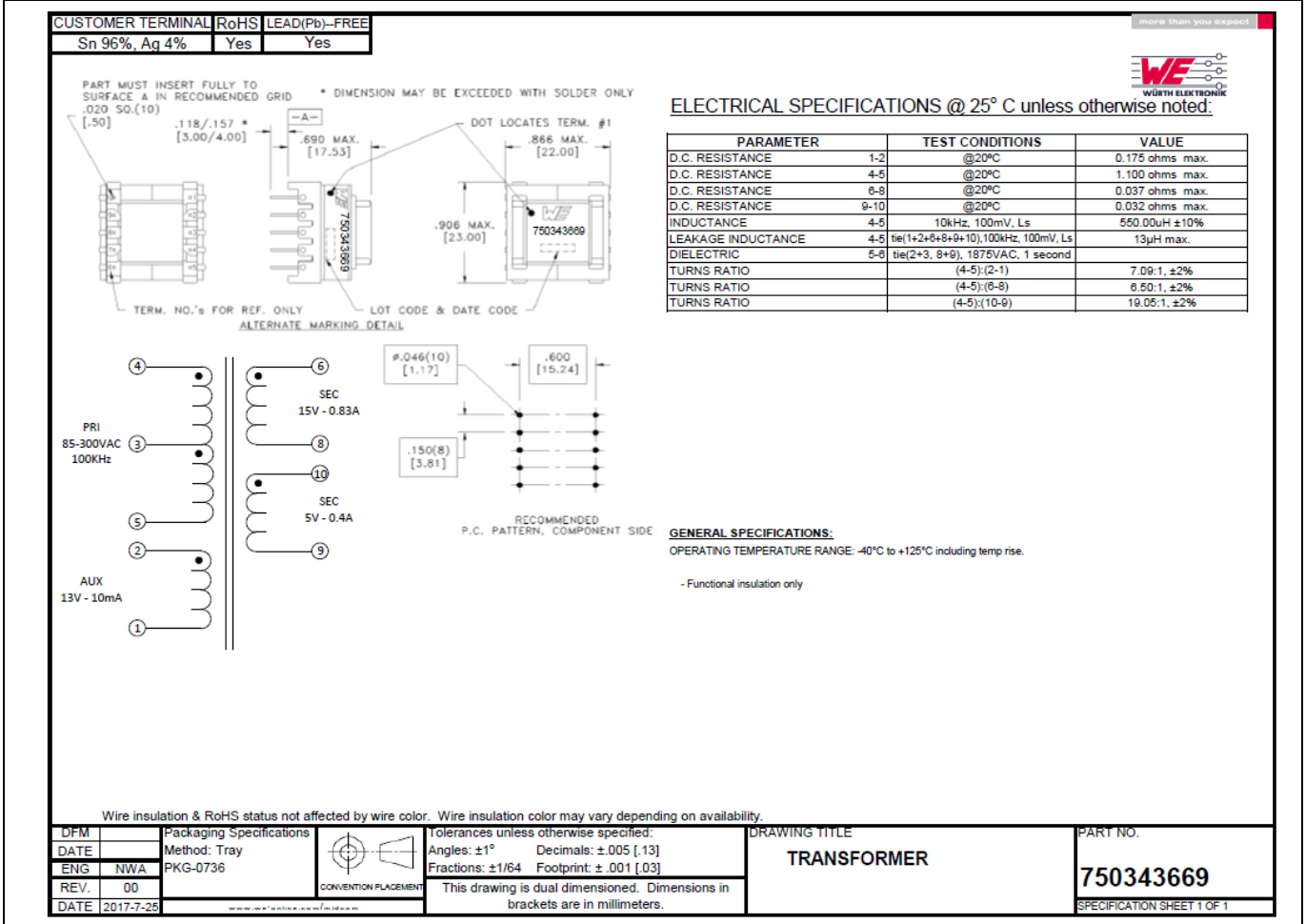
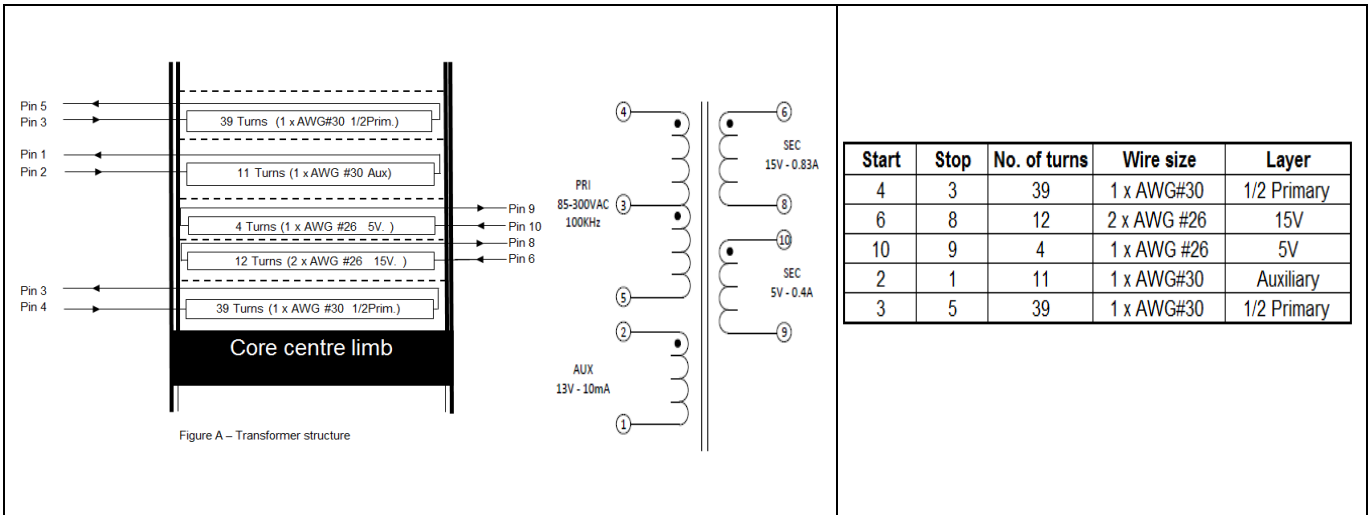

Figure 6 Transformer structure

Test results

10 Test results

10.1 Efficiency, regulation and output ripple

Table 4 Efficiency, regulation and output ripple

Input (V AC/Hz)	P _{IN} (W)	15 V (V)	I _{out_15 V} (mA)	5 V (V)	I _{out_5 V} (mA)	15 V _{RPP} (mV)	5 V _{RPP} (mV)	P _{out} (W)	Efficiency (η) (%)	Average η (%)	OLP P _{IN} (W)	OLP I _{out15 v} (fixed 5 V at 0.4 A) (A)
85 V AC/ 60 Hz	0.039	15.18	0	5.00	0	27.1	12.5				22.70	1.07
	0.129	16.94	0	4.82	12	19.4	23	0.06				
	4.469	15.21	207.8	4.99	100.1	31.8	9.9	3.66	81.90	81.95		
	8.848	15.18	414.7	4.99	200.2	45	10.5	7.29	82.44			
	13.326	15.20	622.3	4.98	300.3	55.1	11.3	10.95	82.20			
	17.992	15.22	829.6	4.98	400.3	64.2	11.5	14.62	81.25			
115 V AC/ 60 Hz	0.043	15.19	0	5.00	0	26.5	13.1				22.03	1.07
	0.134	17.01	0	4.81	12	18.9	24.7	0.06				
	4.428	15.21	207.8	4.99	100.1	31.5	10	3.66	82.66	83.37		
	8.729	15.20	414.7	4.99	200.2	46.8	11.4	7.30	83.65			
	13.090	15.21	622.3	4.98	300.2	55.2	11.9	10.96	83.74			
	17.534	15.23	829.6	4.98	400.2	64.6	12.4	14.63	83.41			
230 V AC/ 50 Hz	0.069	15.24	0	4.99	0	30.7	13.9				21.96	1.10
	0.163	17.14	0	4.80	12	20.7	28.3	0.06				
	4.478	15.21	207.8	4.99	100.1	33.7	10.8	3.66	81.73	83.80		
	8.719	15.25	414.7	4.98	200.2	46.9	11.3	7.32	83.95			
	12.977	15.27	622.3	4.98	300.2	57.5	12.5	11.00	84.73			
	17.266	15.25	829.6	4.98	400.2	73	12.7	14.64	84.81			
265 V AC/ 50 Hz	0.080	15.24	0	4.99	0	30.5	13				22.41	1.13
	0.168	17.18	0	4.80	12	21.5	25.8	0.06				
	4.513	15.21	207.8	4.99	100.1	33.9	11.2	3.66	81.12	83.46		
	8.750	15.24	414.7	4.99	200.2	48.8	12.5	7.32	83.61			
	13.034	15.27	622.3	4.98	300.2	59	12.8	11.00	84.39			
	17.300	15.27	829.6	4.98	400.2	69.8	13.5	14.66	84.72			
300 V AC/ 50 Hz	0.093	15.25	0	4.99	0	34.2	13.7				22.95	1.15
	0.188	17.21	0	4.79	12	22.4	28.6	0.06				
	4.558	15.23	207.8	4.99	100.1	35.5	12.5	3.66	80.38	82.94		
	8.834	15.23	414.7	4.99	200.2	49.8	13.2	7.31	82.79			
	13.085	15.26	622.3	4.98	300.2	60.2	12.5	10.99	84.00			
	17.348	15.29	829.6	4.98	400.2	70.4	13.7	14.67	84.59			

60 mW load condition: 5 V @ 12 mA and 15 V @ 0 mA

Full-load condition: 5 V @ 400 mA and 15 V @ 830 mA

Test results

10.2 Efficiency

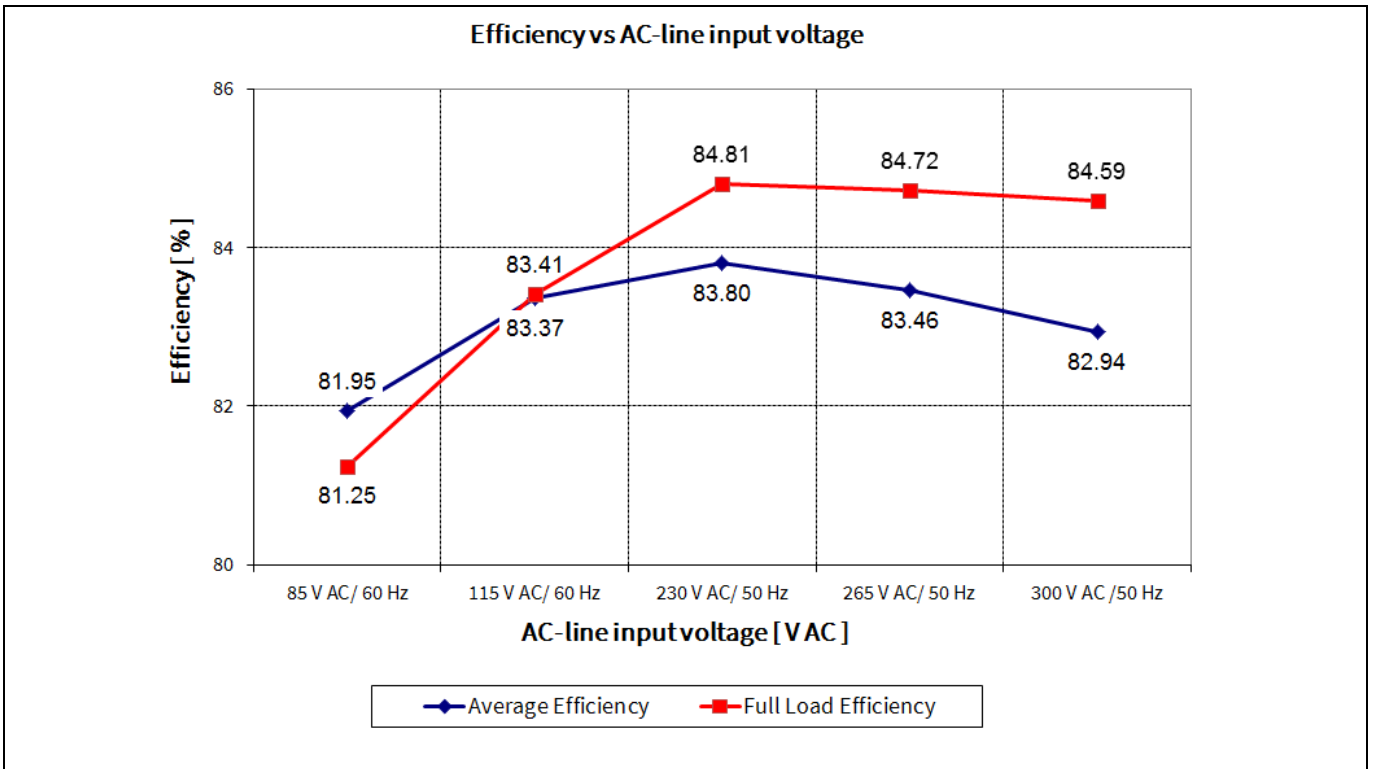

Figure 7 Efficiency vs AC-line input voltage

10.3 Standby power

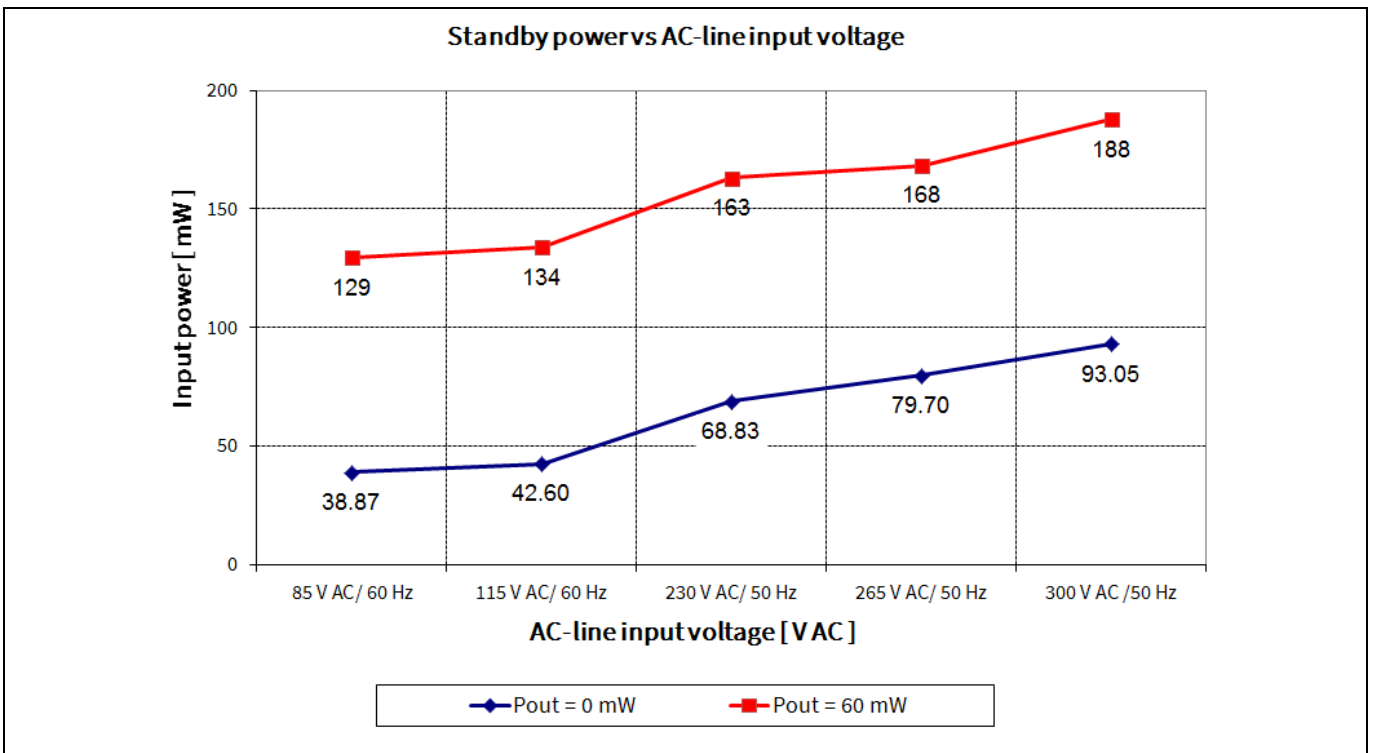

Figure 8 Standby power vs AC-line input voltage (measured by Yokogawa WT310HC power meter – integration mode)

Test results

10.4 Line regulation

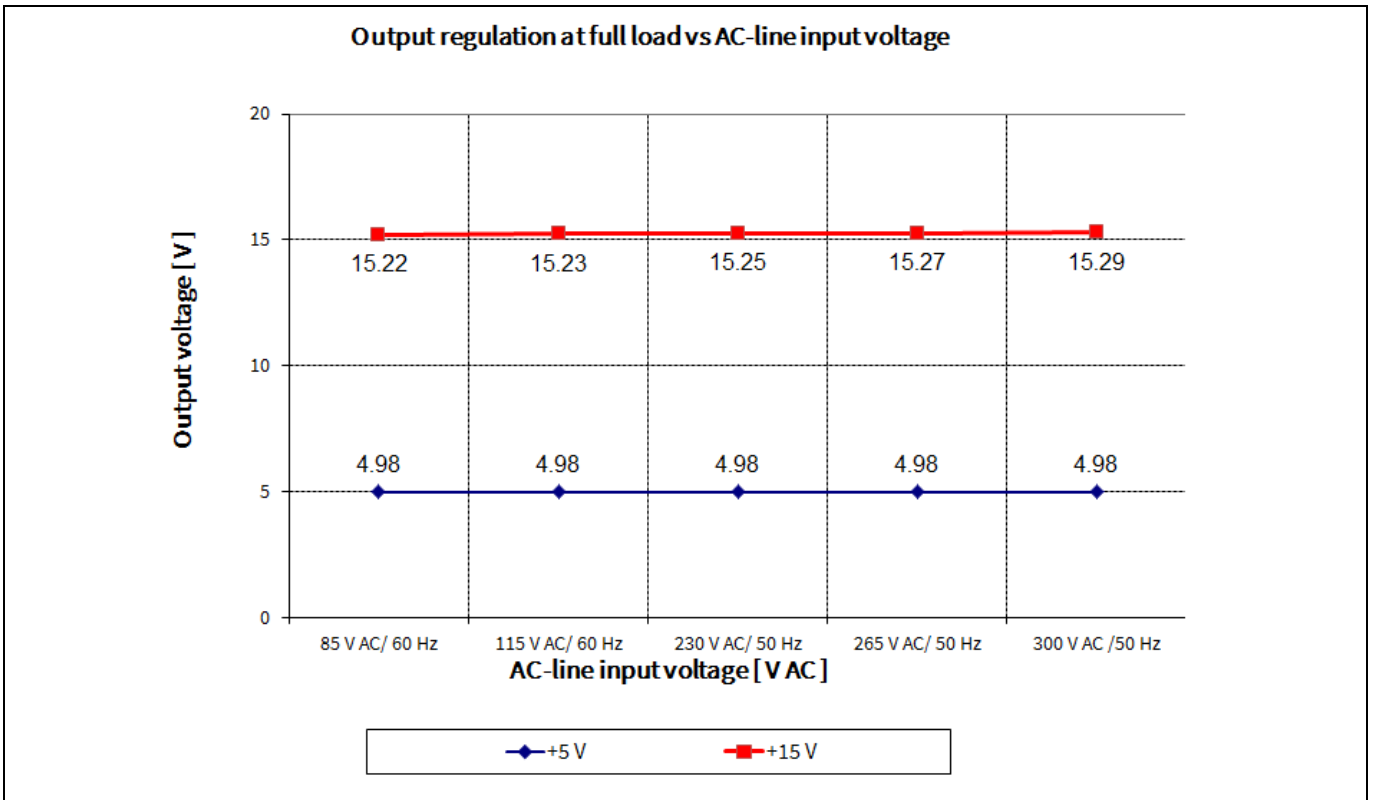

Figure 9 Output regulation at full load vs AC-line input voltage

10.5 Load regulation

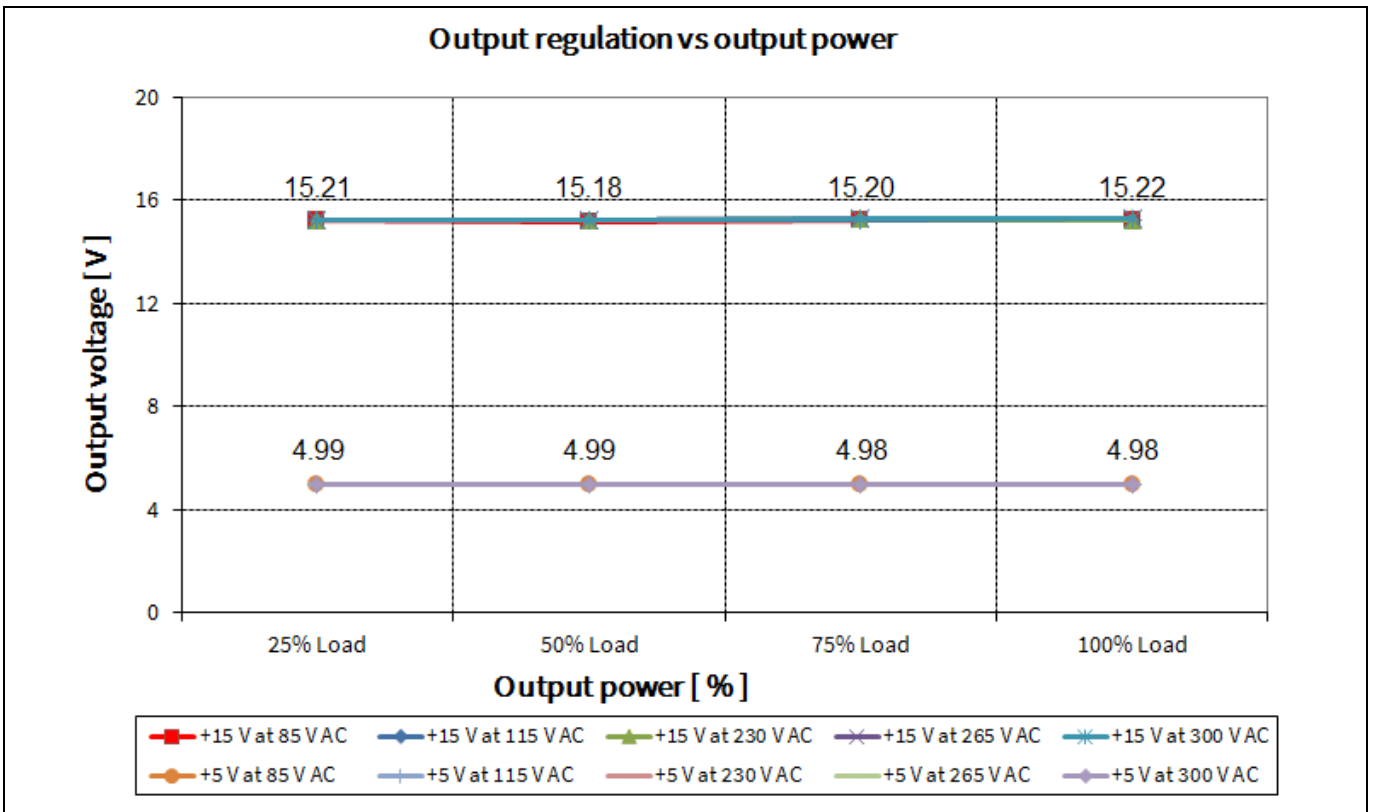

Figure 10 Output regulation vs output power

Test results

10.6 Maximum input power

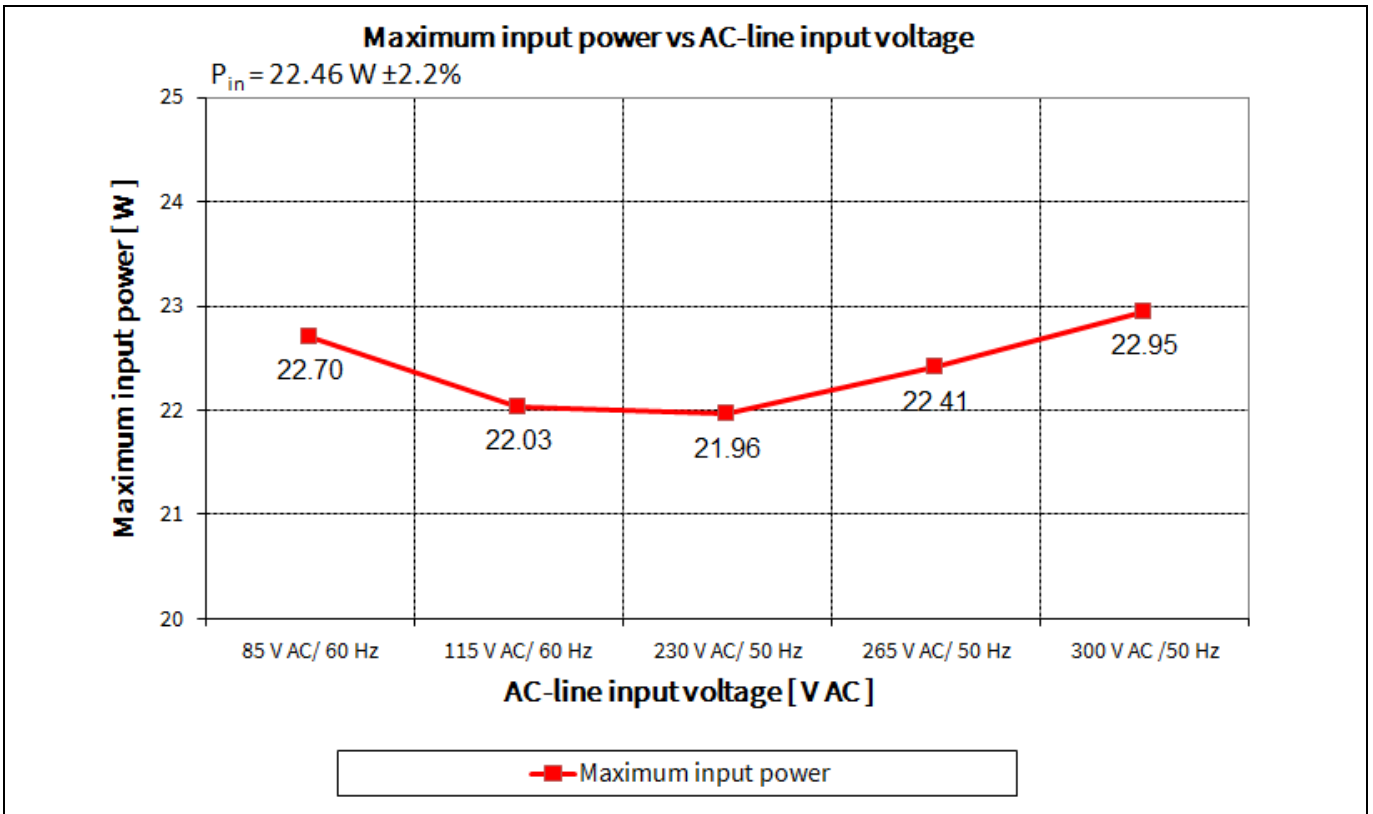

Figure 11 Maximum input power (before over-load protection) vs AC-line input voltage

10.7 Frequency reduction

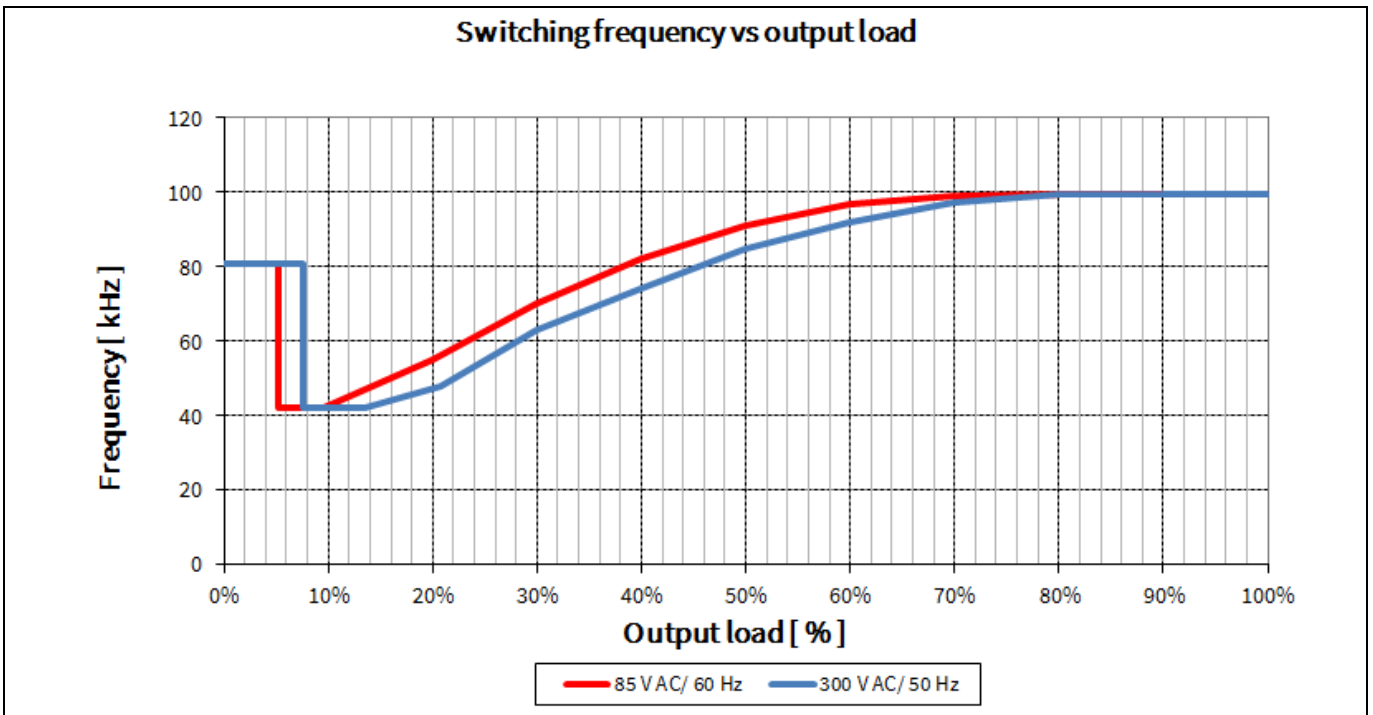

Figure 12 Frequency reduction curve vs output load

Test results

10.8 Surge immunity (EN 61000-4-5)

Pass EN 61000-4-5 installation class 4 (± 2 kV for line-to-line).¹

10.9 Conducted emissions (EN 55022 class B)

The conducted EMI was measured by Schaffner (SMR4503) and followed the test standard of EN 55022 (CISPR 22) class B. The demo board is tested at full load (14.45 W) using resistive load at an input voltage of 115 V AC and 230 V AC.

Pass conducted emissions EN 55022 (CISPR 22) class B with 6.3 dB margin at low-line (115 V AC) and 8.4 dB margin at high-line (230 V AC).

¹ PCB spark-gap distance needs to reduce to 0.5 mm.

Test results

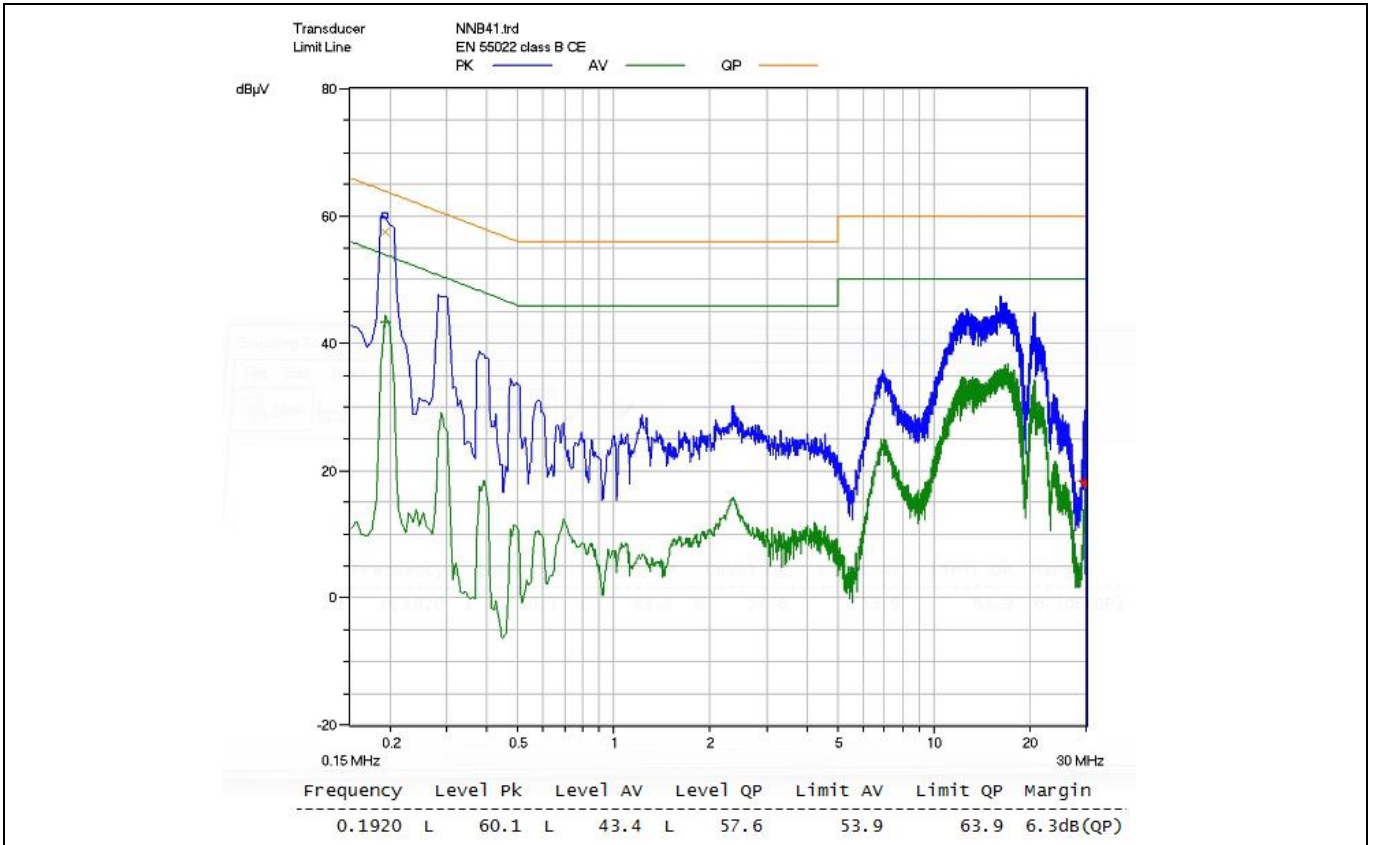

Figure 13 Conducted emissions (line) at 115 V AC and full load

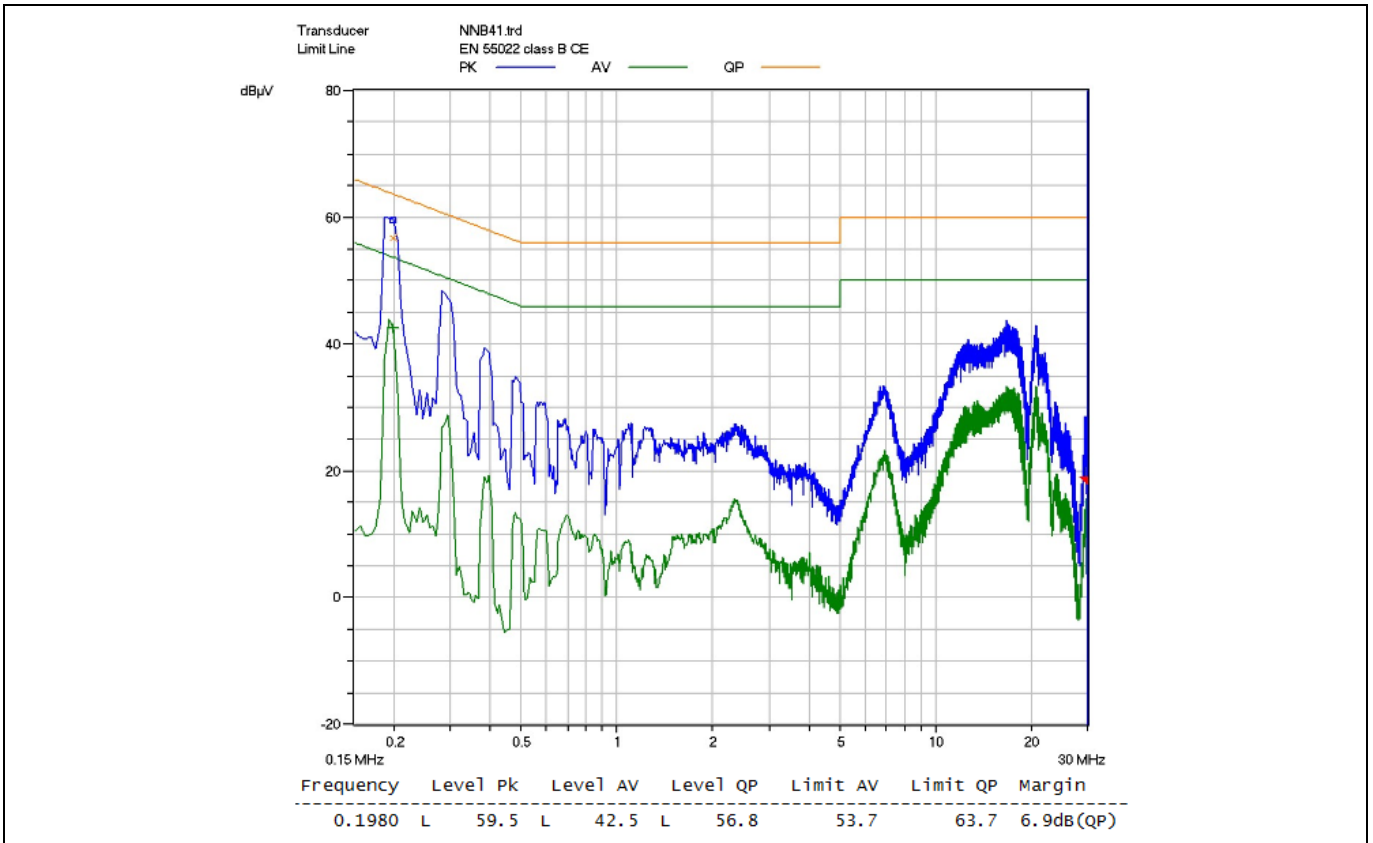

Figure 14 Conducted emissions (neutral) at 115 V AC and full load

Test results

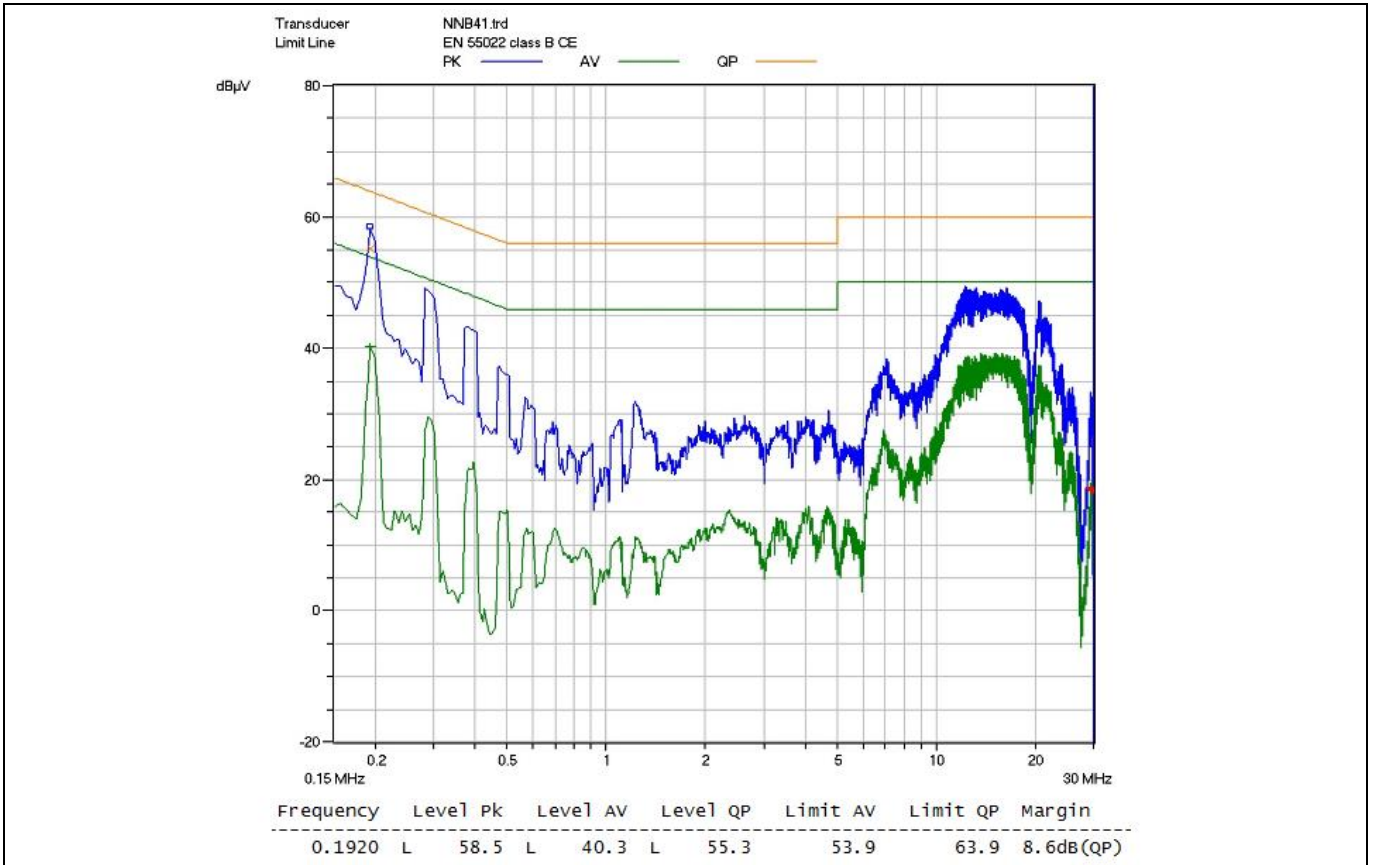

Figure 15 Conducted emissions (line) at 230 V AC and full load

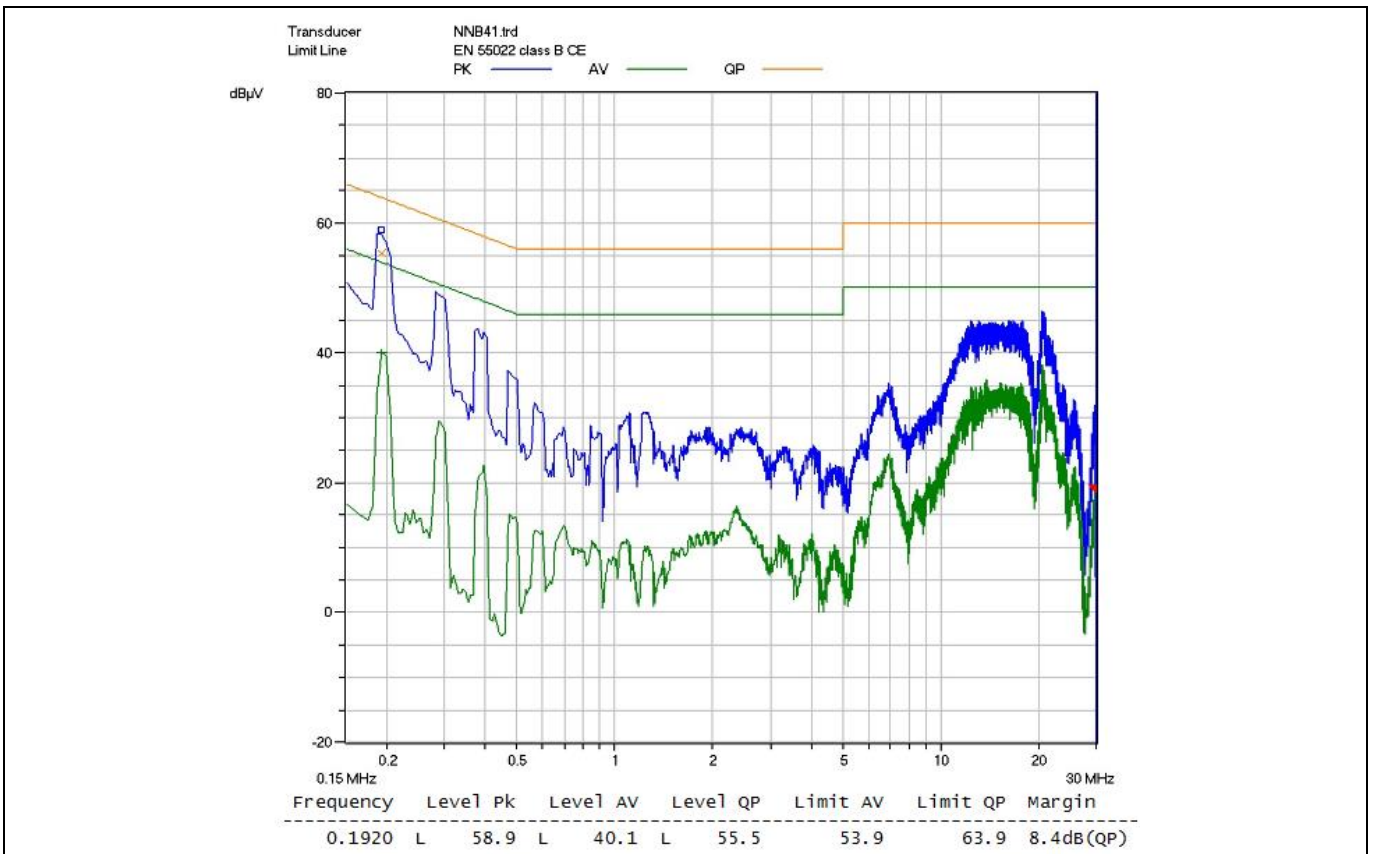

Figure 16 Conducted emissions (neutral) at 230 V AC and full load

Test results

10.10 Thermal measurements

The thermal test of the open-frame demo board was done using an infrared thermography camera (FLIR-T62101) at an ambient temperature of 25°C. The measurements were taken after one hour running at full load.

Table 5 Hottest components on the demo board

No.	Components	Temperature @ 85 V AC (°C)	Temperature @ 300 V AC (°C)
1	IC1 (ICE5AR4770AG)	81.2	63.3
2	L1 (CMC)	45.5	29.6
3	T1 (transformer)	55.7	60.4
4	D151 (15 V diode)	63	65.3

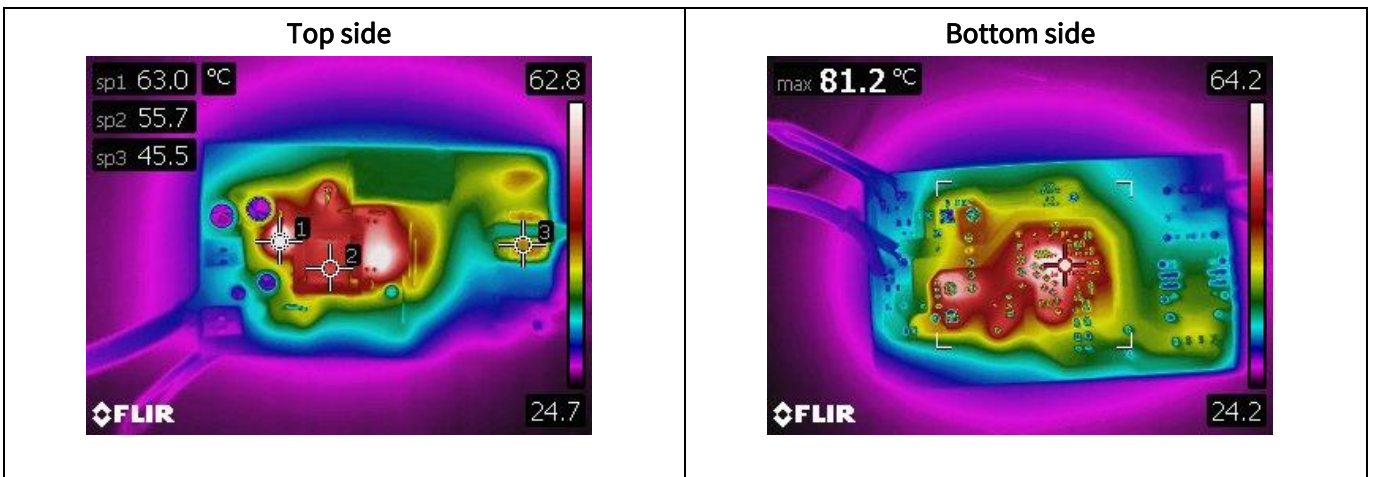

Figure 17 Infrared thermal image of DEMO_5AR4770AG at 85 V AC full load

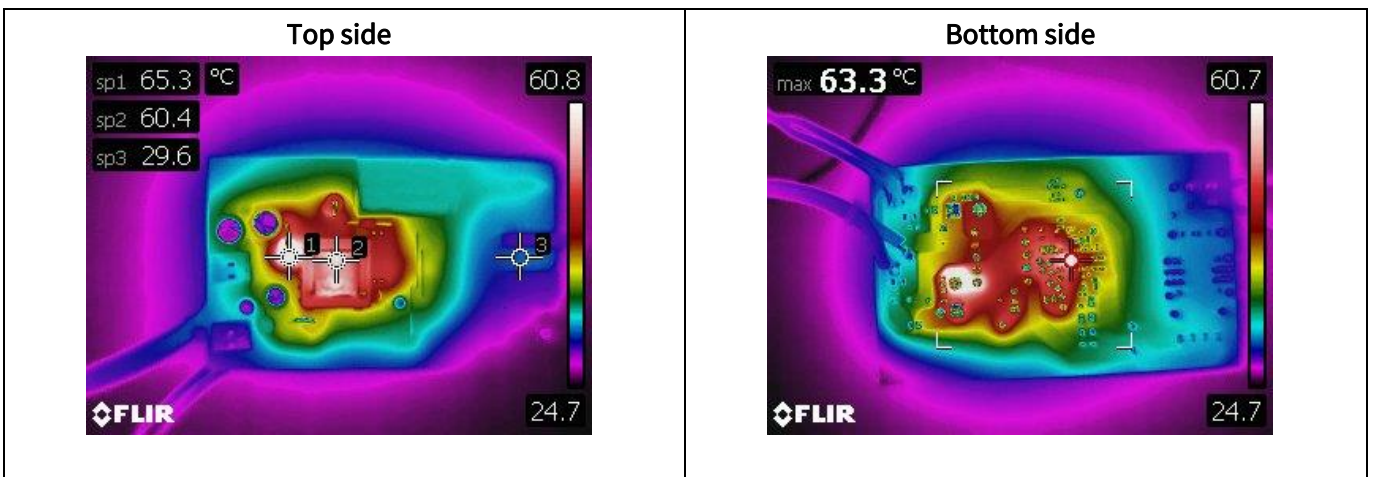

Figure 18 Infrared thermal image of DEMO_5AR4770AG at 300 V AC full load

Waveforms and oscilloscope plots

11 Waveforms and oscilloscope plots

All waveforms and scope plots were recorded with a Teledyne LeCroy 606Zi oscilloscope.

11.1 Start-up at full load

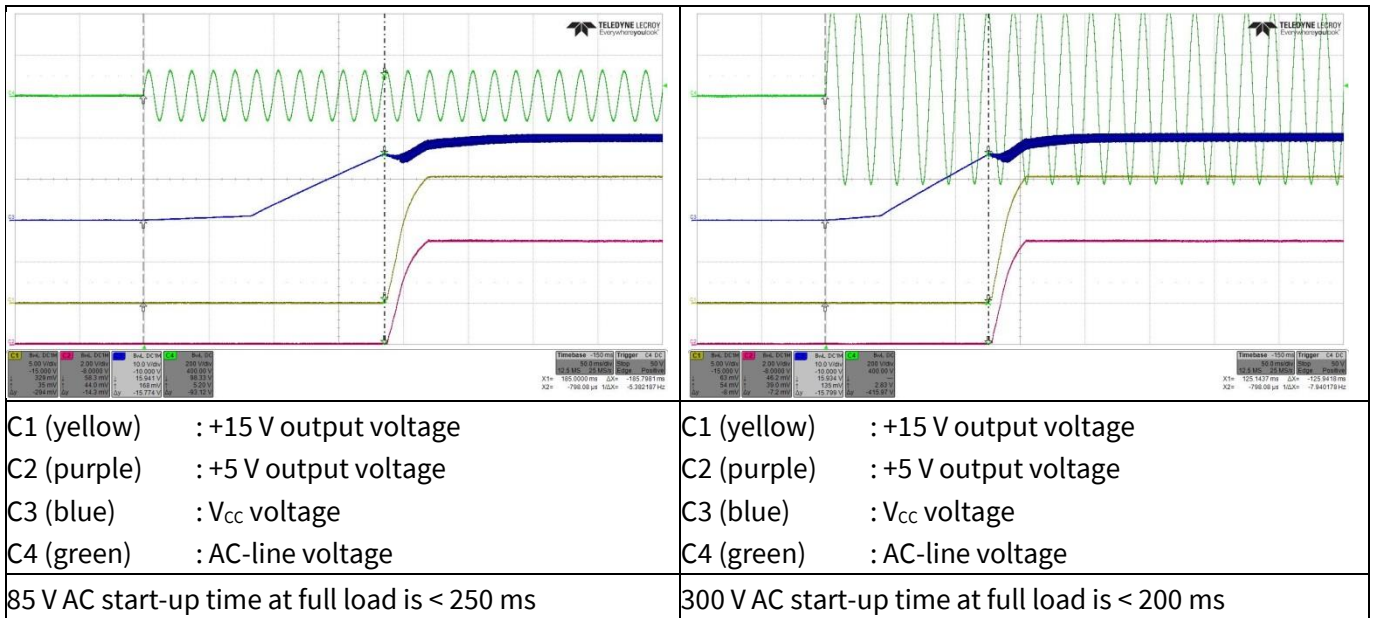

Figure 19 Start-up

11.2 Soft-start at full load

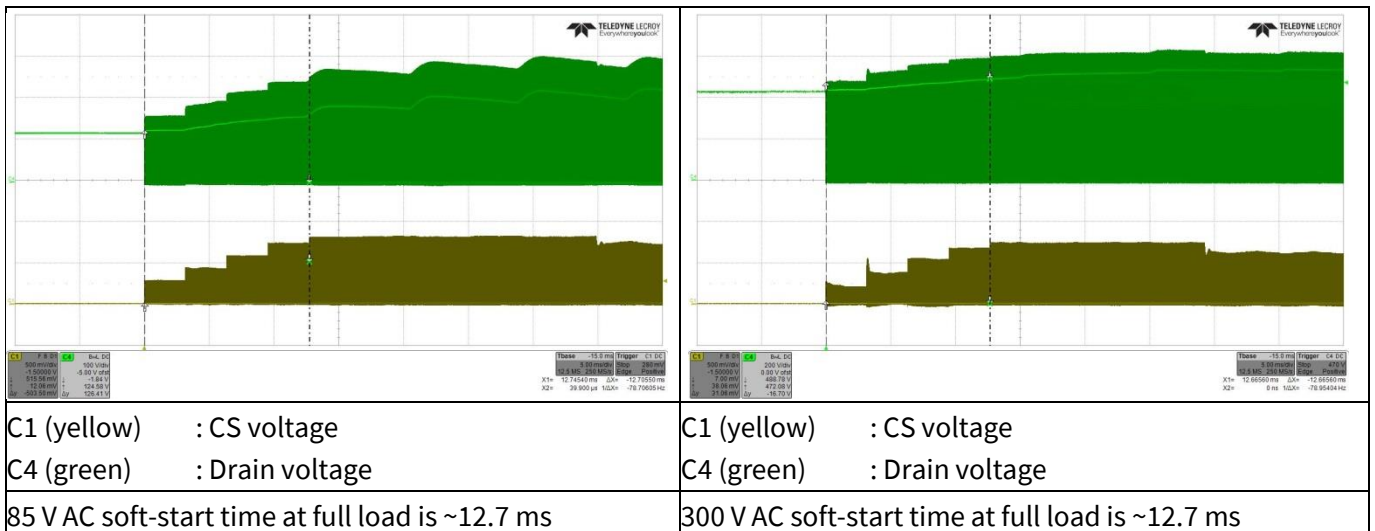

Figure 20 Soft-start

14 W 15 V 5 V SMPS demo board with ICE5AR4770AG

DEMO_5AR4770AG_14W1

Waveforms and oscilloscope plots

11.3 Drain and CS voltage at full load

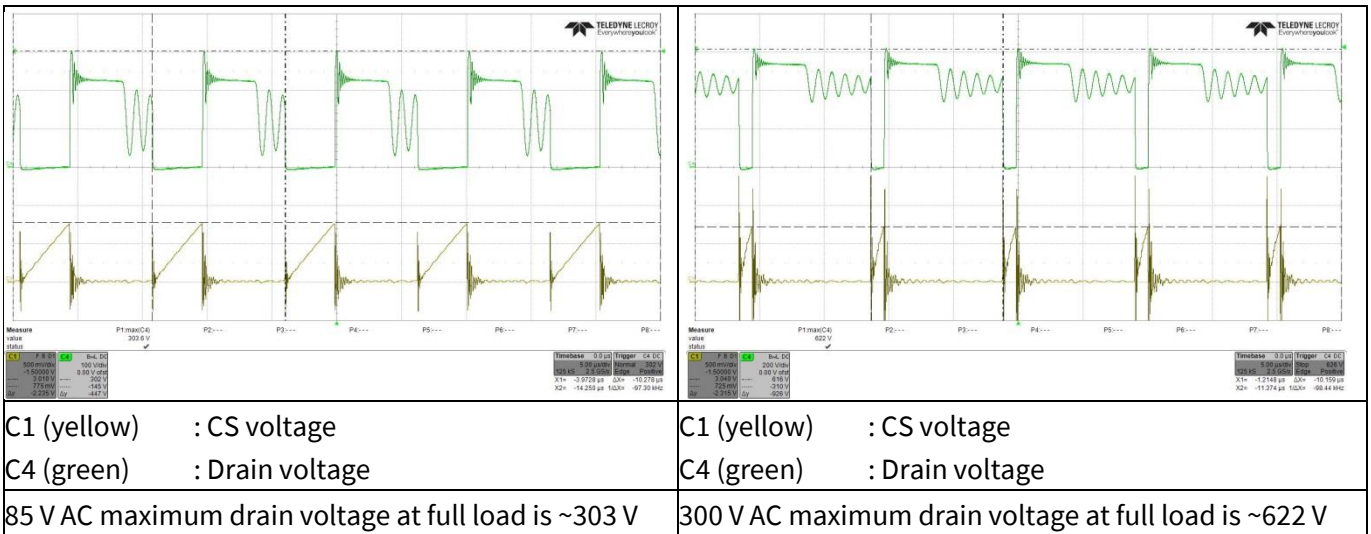

Figure 21 Drain and CS voltage

11.4 Frequency jittering at full load

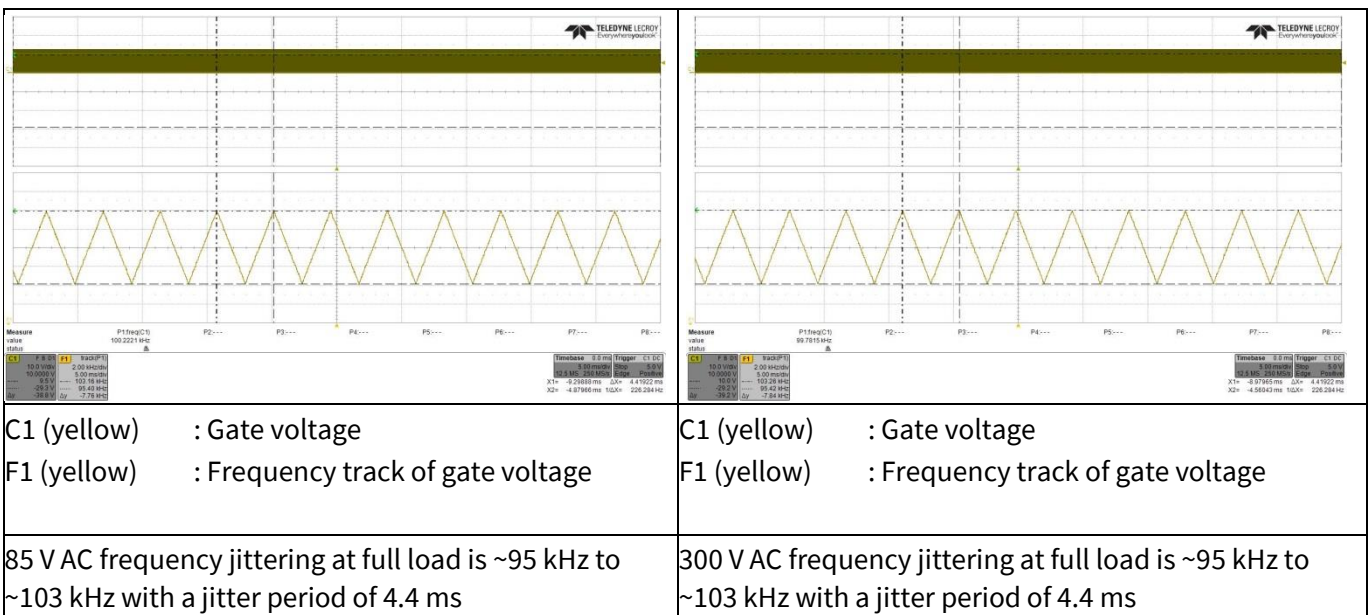

Figure 22 Frequency jittering

Waveforms and oscilloscope plots

11.5 Load transient response (dynamic load from 10% to 100%)

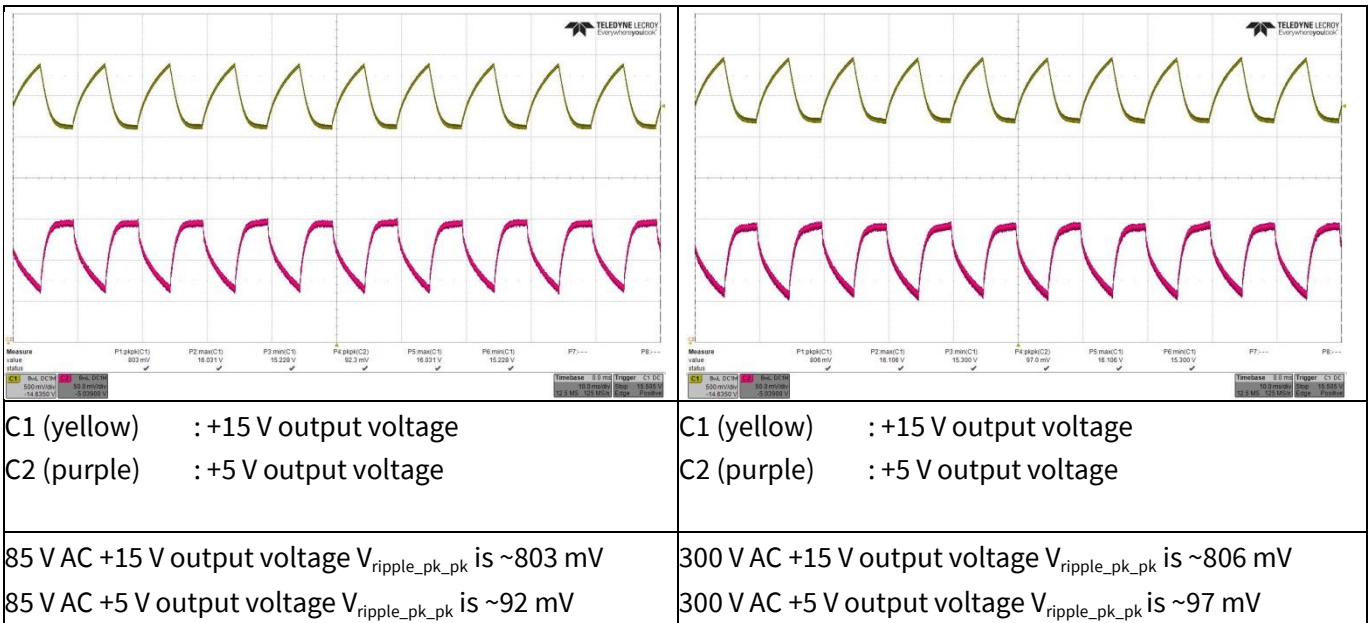

Figure 23 Load transient response with +15 V output load change from 10% to 100% at 0.4 A/ μ s slew rate, 100 Hz. +5 V output is fixed at 400 mA load. Probe terminals are decoupled with 1 μ F electrolytic and 0.1 μ F ceramic capacitors. Oscilloscope is BW filter limited to 20 MHz.

11.6 Output ripple voltage at full load

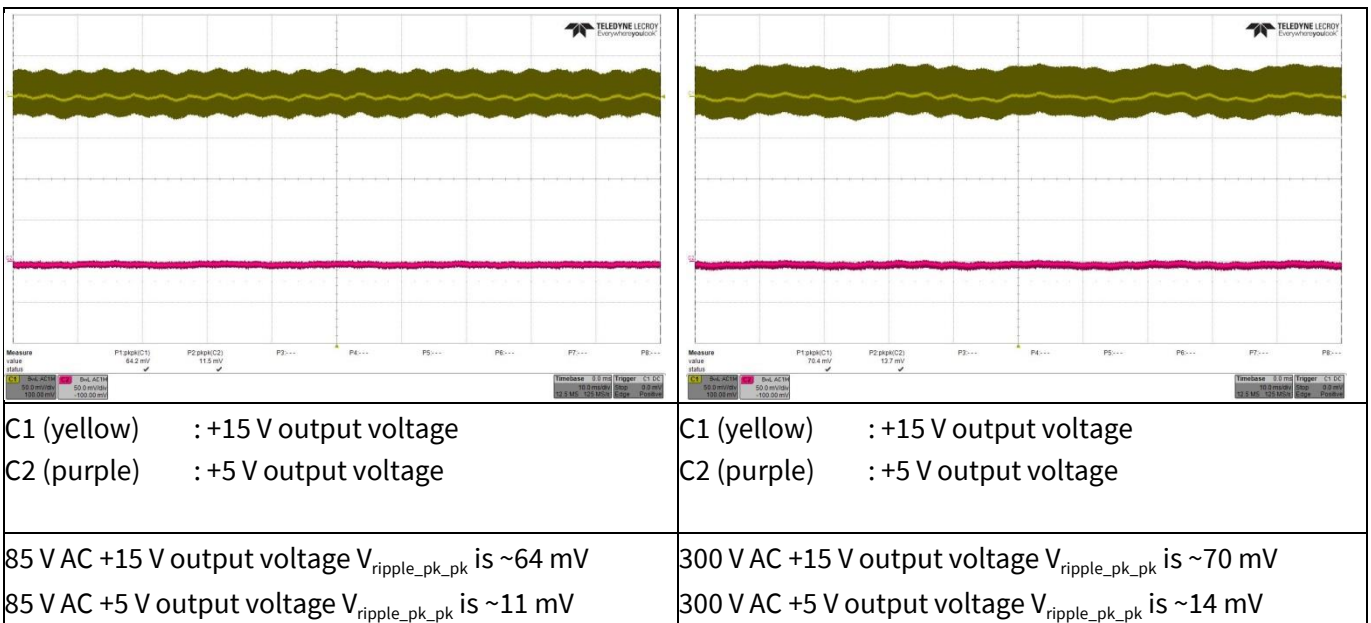

Figure 24 Output ripple voltage at full load. Probe terminals are decoupled with 1 μ F electrolytic and 0.1 μ F ceramic capacitors. Oscilloscope is BW filter limited to 20 MHz.

Waveforms and oscilloscope plots

11.7 Output ripple voltage at ABM (0.5 W load)

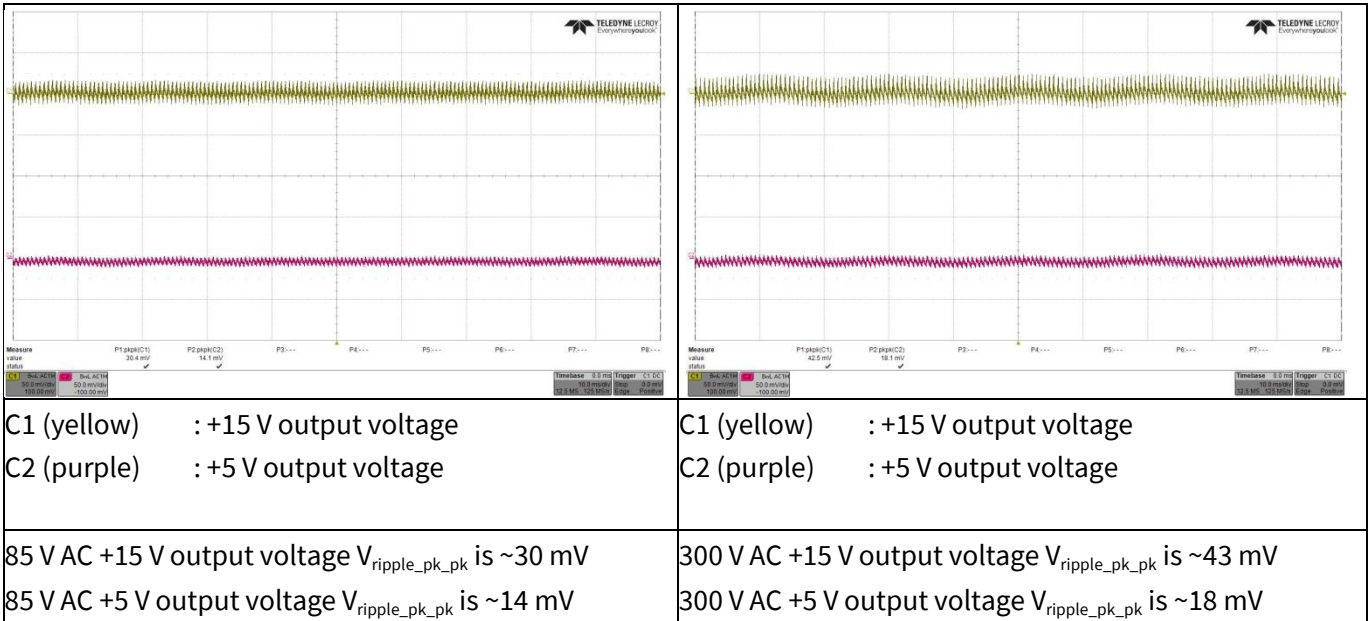

Figure 25 Output ripple voltage at 0.5 W load (+15 V/30 mA, +5 V/12 mA). Probe terminals are decoupled with 1 μ F electrolytic and 0.1 μ F ceramic capacitors. Oscilloscope is BW filter limited to 20 MHz.

11.8 Entering ABM

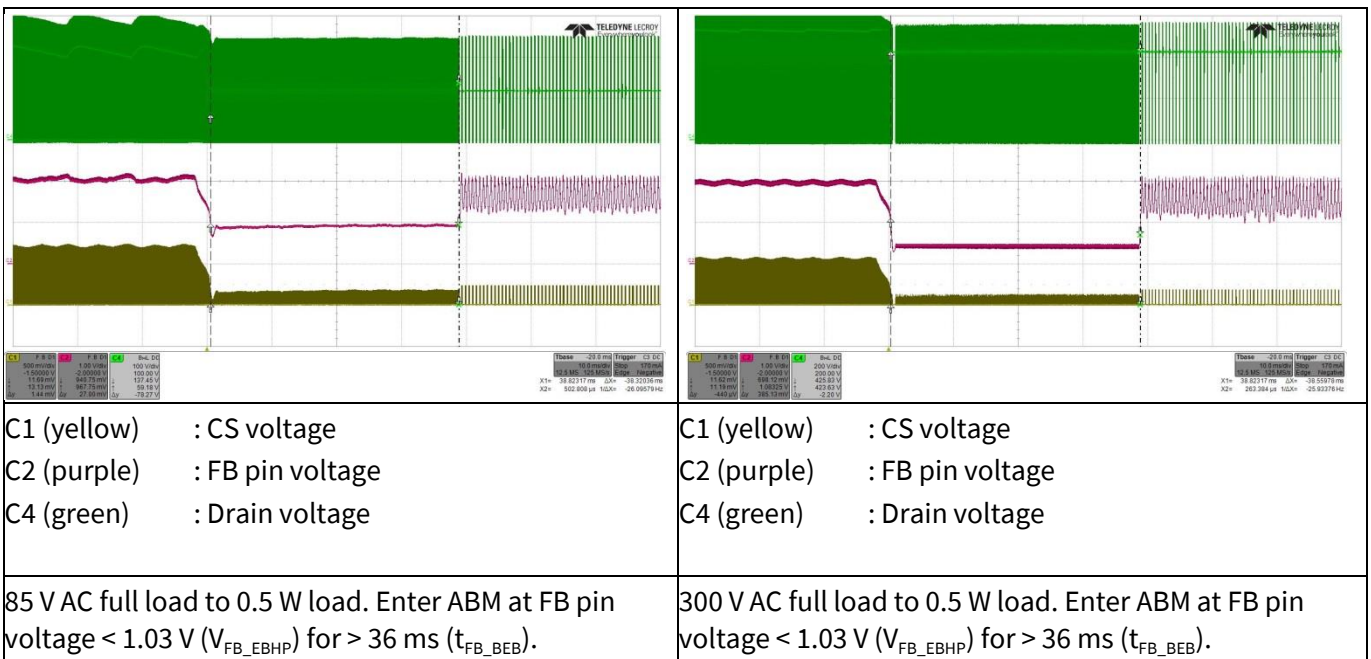

Figure 26 Entering ABM. Output at full load to 0.5 W load (+15 V/30 mA, +5 V/12 mA).

14 W 15 V 5 V SMPS demo board with ICE5AR4770AG

DEMO_5AR4770AG_14W1

Waveforms and oscilloscope plots

11.9 During ABM

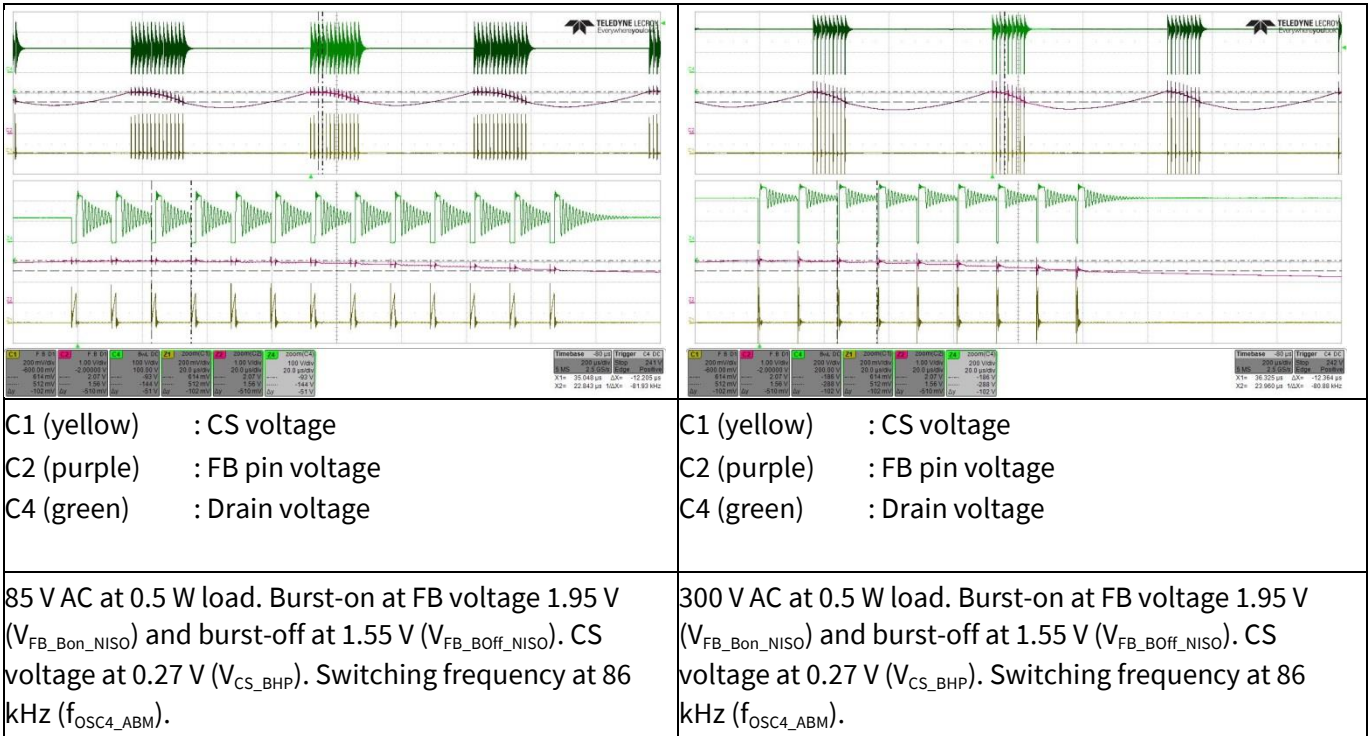

Figure 27 During ABM. Output at 0.5 W load (+15 V/30 mA, +5 V/12 mA).

11.10 Leaving ABM

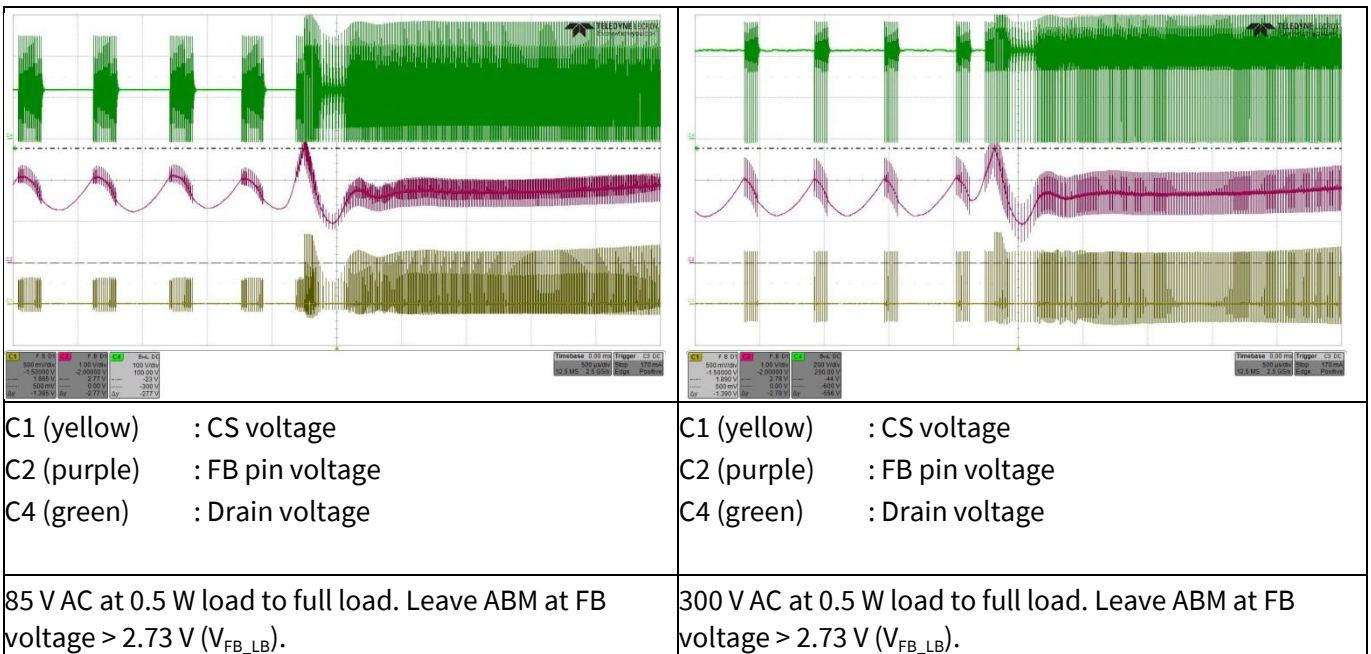

Figure 28 Leaving ABM. Output at 0.5 W load (+15 V/30 mA, +5 V/12 mA) to full load.

11.11 Line OVP (non-switch auto restart)

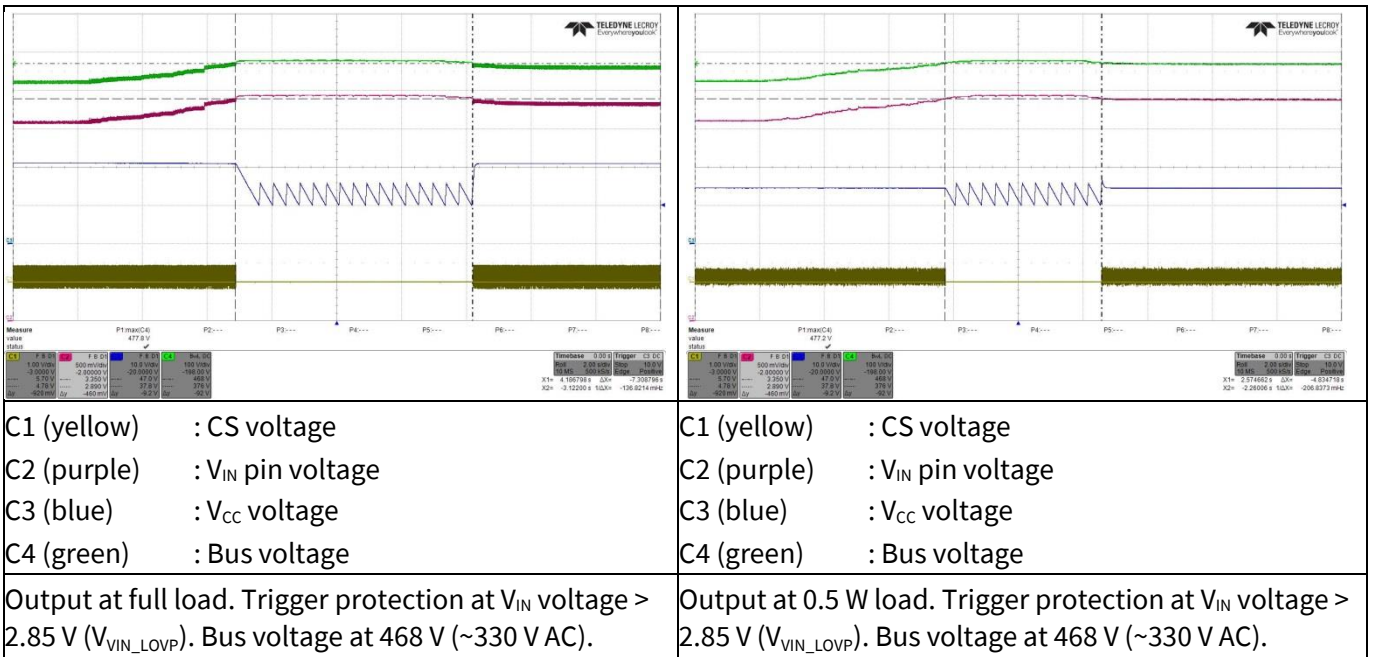

Figure 29 Line OVP. Gradually increase input voltage to trigger protection and gradually reduce input voltage to reset.

11.12 V_{CC} OV/UV protection

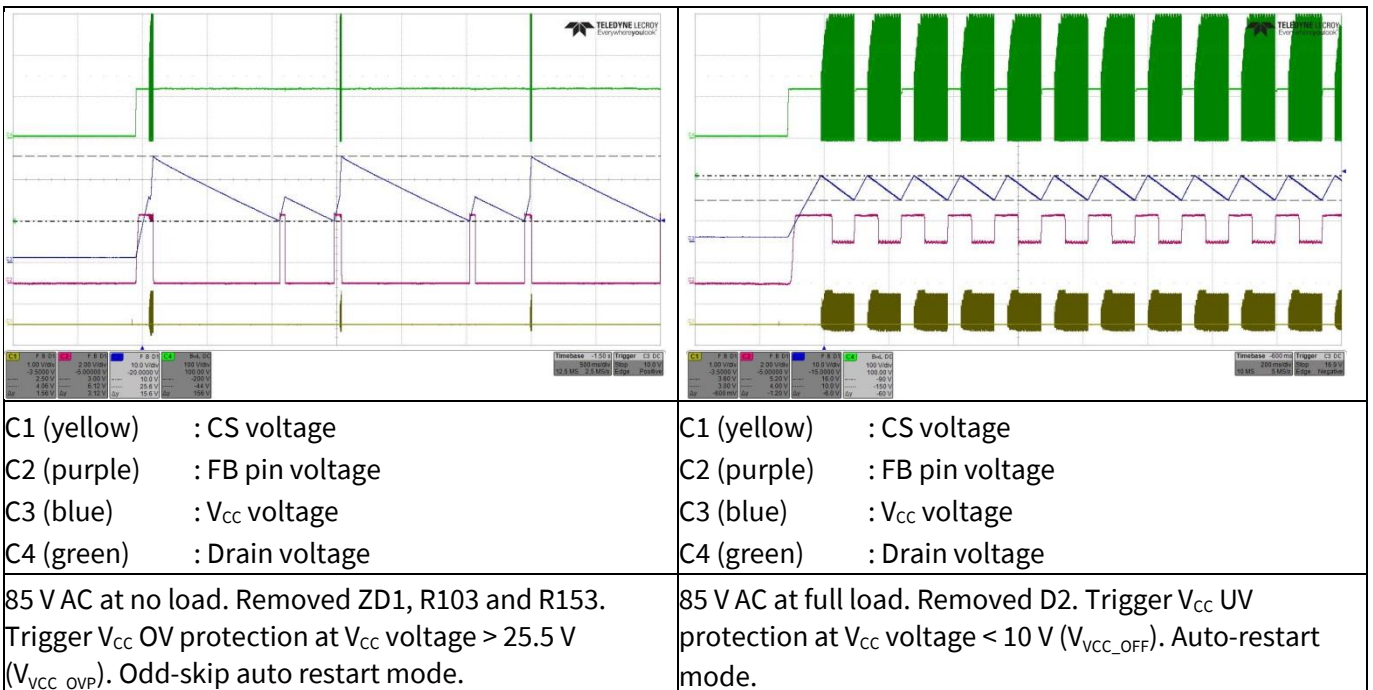

Figure 30 V_{CC} OV/UV protection

14 W 15 V 5 V SMPS demo board with ICE5AR4770AG

DEMO_5AR4770AG_14W1

Waveforms and oscilloscope plots

11.13 Over-load protection

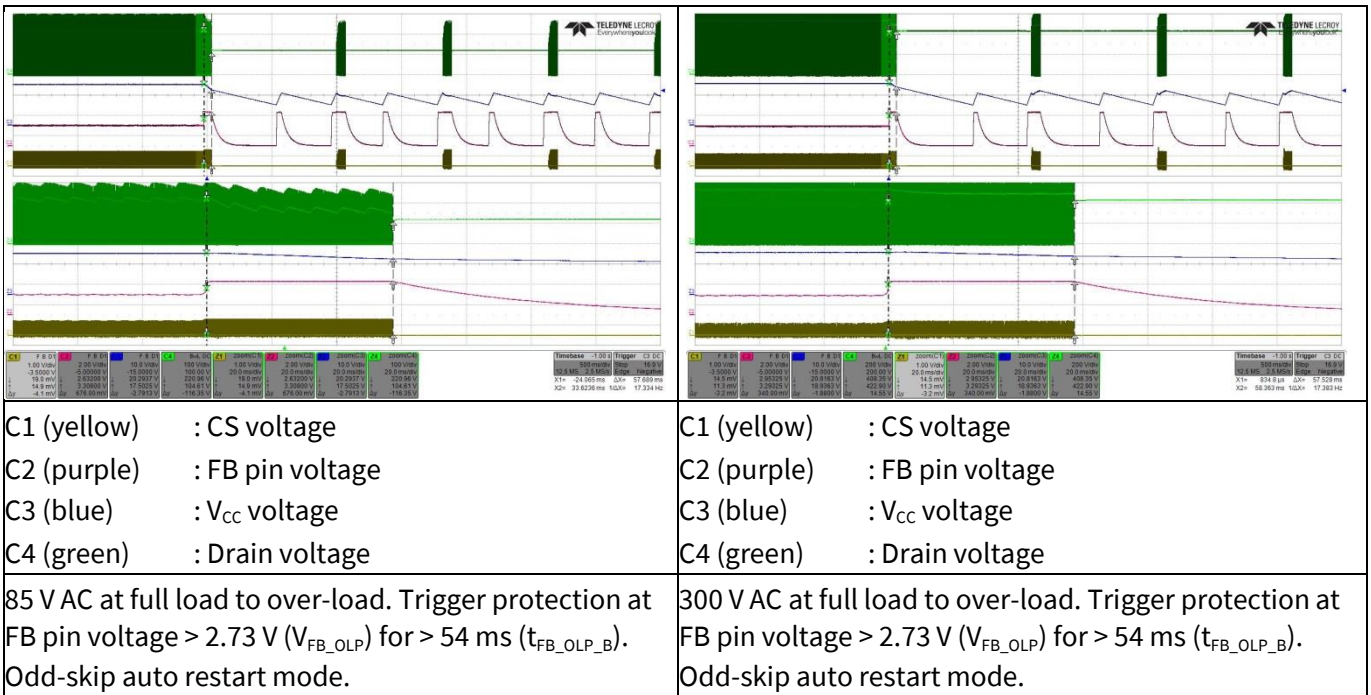

Figure 31 Over-load protection. Load increased at +15 V output to 2 A to trigger protection.

11.14 V_{CC} short-to-GND

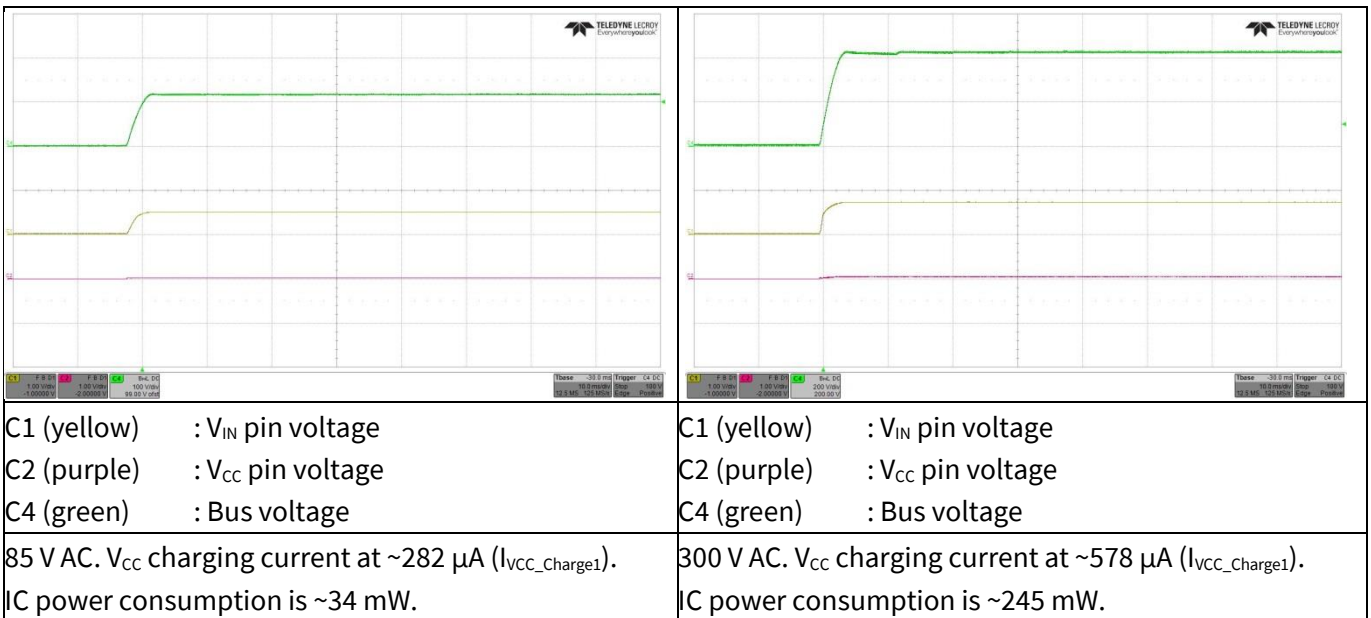

Figure 32 V_{CC} short-to-GND. V_{CC} charging current measured with a digital multimeter.

References

12 References

- [1] ICE5xRxxxxAG datasheet, Infineon Technologies AG
- [2] 5th Generation Fixed-Frequency Design Guide
- [3] Calculation Tool Fixed Frequency CoolSET™ Generation 5

Revision history

Major changes since the last revision

Page or reference	Description of changes
--	First release

Trademarks

All referenced product or service names and trademarks are the property of their respective owners.

Edition 2018-02-20

Published by

Infineon Technologies AG

81726 Munich, Germany

© 2018 Infineon Technologies AG.

All Rights Reserved.

Do you have a question about this document?

Email: erratum@infineon.com

Document reference

ER_201708_PL83_016

IMPORTANT NOTICE

The information contained in this application note is given as a hint for the implementation of the product only and shall in no event be regarded as a description or warranty of a certain functionality, condition or quality of the product. Before implementation of the product, the recipient of this application note must verify any function and other technical information given herein in the real application. Infineon Technologies hereby disclaims any and all warranties and liabilities of any kind (including without limitation warranties of non-infringement of intellectual property rights of any third party) with respect to any and all information given in this application note.

The data contained in this document is exclusively intended for technically trained staff. It is the responsibility of customer's technical departments to evaluate the suitability of the product for the intended application and the completeness of the product information given in this document with respect to such application.

For further information on the product, technology, delivery terms and conditions and prices please contact your nearest Infineon Technologies office (www.infineon.com).

WARNINGS

Due to technical requirements products may contain dangerous substances. For information on the types in question please contact your nearest Infineon Technologies office.

Except as otherwise explicitly approved by Infineon Technologies in a written document signed by authorized representatives of Infineon Technologies, Infineon Technologies' products may not be used in any applications where a failure of the product or any consequences of the use thereof can reasonably be expected to result in personal injury.

Компания «Океан Электроники» предлагает заключение долгосрочных отношений при поставках импортных электронных компонентов на взаимовыгодных условиях!

Наши преимущества:

- Поставка оригинальных импортных электронных компонентов напрямую с производств Америки, Европы и Азии, а так же с крупнейших складов мира;
- Широкая линейка поставок активных и пассивных импортных электронных компонентов (более 30 млн. наименований);
- Поставка сложных, дефицитных, либо снятых с производства позиций;
- Оперативные сроки поставки под заказ (от 5 рабочих дней);
- Экспресс доставка в любую точку России;
- Помощь Конструкторского Отдела и консультации квалифицированных инженеров;
- Техническая поддержка проекта, помощь в подборе аналогов, поставка прототипов;
- Поставка электронных компонентов под контролем ВП;
- Система менеджмента качества сертифицирована по Международному стандарту ISO 9001;
- При необходимости вся продукция военного и аэрокосмического назначения проходит испытания и сертификацию в лаборатории (по согласованию с заказчиком);
- Поставка специализированных компонентов военного и аэрокосмического уровня качества (Xilinx, Altera, Analog Devices, Intersil, Interpoint, Microsemi, Actel, Aeroflex, Peregrine, VPT, Syfer, Eurofarad, Texas Instruments, MS Kennedy, Miteq, Cobham, E2V, MA-COM, Hittite, Mini-Circuits, General Dynamics и др.);

Компания «Океан Электроники» является официальным дистрибьютором и эксклюзивным представителем в России одного из крупнейших производителей разъемов военного и аэрокосмического назначения «JONHON», а так же официальным дистрибьютором и эксклюзивным представителем в России производителя высокотехнологичных и надежных решений для передачи СВЧ сигналов «FORSTAR».



JONHON

«JONHON» (основан в 1970 г.)

Разъемы специального, военного и аэрокосмического назначения:

(Применяются в военной, авиационной, аэрокосмической, морской, железнодорожной, горно- и нефтедобывающей отраслях промышленности)

«FORSTAR» (основан в 1998 г.)

ВЧ соединители, коаксиальные кабели, кабельные сборки и микроволновые компоненты:

(Применяются в телекоммуникациях гражданского и специального назначения, в средствах связи, РЛС, а так же военной, авиационной и аэрокосмической отраслях промышленности).



Телефон: 8 (812) 309-75-97 (многоканальный)

Факс: 8 (812) 320-03-32

Электронная почта: ocean@oceanchips.ru

Web: <http://oceanchips.ru/>

Адрес: 198099, г. Санкт-Петербург, ул. Калинина, д. 2, корп. 4, лит. А