

FEATURES

Gain: 14.5 dB typical at 50 GHz to 70 GHz
S11: 22 dB typical at 50 GHz to 70 GHz
S22: 19 dB typical at 50 GHz to 70 GHz
P1dB: 17 dBm typical at 50 GHz to 70 GHz
P_{SAT}: 21 dBm typical
OIP3: 25 dBm typical at 70 GHz to 90 GHz
Supply voltage: 3.5 V at 350 mA
50 Ω matched input/output
Die size: 2.5 mm × 3.32 mm × 0.05 mm

APPLICATIONS

Test instrumentation
 Military and space
 Telecommunications infrastructure

GENERAL DESCRIPTION

The ADPA7001CHIPS is a gallium arsenide (GaAs), pseudo-morphic high electron mobility transistor (pHEMT), monolithic microwave integrated circuit (MMIC), balanced medium power amplifier, with an integrated temperature compensated on-chip power detector that operates from 50 GHz to 95 GHz. In the lower band of 50 GHz to 70 GHz, the ADPA7001CHIPS provides 14.5 dB (typical) of gain, 25.5 dBm output third-order intercept (OIP3), and 17 dBm of output power for 1 dB gain compression.

FUNCTIONAL BLOCK DIAGRAM

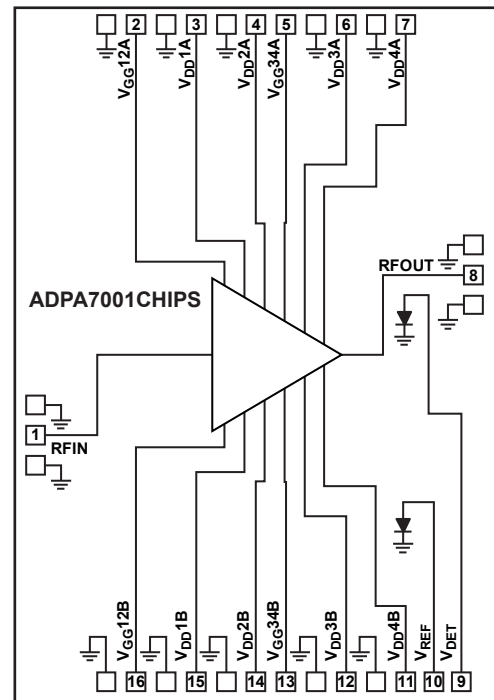

Figure 1.

In the upper band of 70 GHz to 90 GHz, the ADPA7001CHIPS provides 14 dB (typical) of gain, 25 dBm output IP3, and 17.5 dBm of output power for 1 dB gain compression. The ADPA7001CHIPS requires 350 mA from a 3.5 V supply. The ADPA7001CHIPS amplifier inputs/outputs are internally matched to 50 Ω, facilitating integration into multichip modules (MCMs). All data is taken with the chip connected via one 0.076 mm (3 mil) ribbon bond of 0.076 mm (3 mil) minimal length.

TABLE OF CONTENTS

Features	1	Pin Configuration and Function Descriptions.....	6
Applications.....	1	Interface Schematics	7
Functional Block Diagram	1	Typical Performance Characteristics	8
General Description	1	Theory of Operation	13
Revision History	2	Applications Information	14
Specifications.....	3	Mounting and Bonding Techniques for Millimeterwave	
50 GHz to 70 GHz Frequency Range.....	3	GaAs MMICs	14
70 GHz to 90 GHz Frequency Range.....	3	Typical Application Circuit.....	16
90 GHz to 95 GHz Frequency Range.....	4	Assembly Diagram	17
Absolute Maximum Ratings.....	5	Outline Dimensions	18
Thermal Resistance	5	Ordering Guide	18
ESD Caution.....	5		

REVISION HISTORY

10/2019—Rev. A to Rev. B

Added Figure 19 and Figure 22; Renumbered Sequentially 9

3/2019—Rev. 0 to Rev. A

Changes to Figure 44..... 16

8/2018—Revision 0: Initial Version

SPECIFICATIONS

50 GHz TO 70 GHz FREQUENCY RANGE

$T_{DIE\ BOTTOM} = 25^{\circ}C$, $V_{DD} = V_{DD1A} = V_{DD2A} = V_{DD3A} = V_{DD4A} = 3.5\ V$ and supply current (I_{DQ}) = $I_{DQ1A} + I_{DQ2A} + I_{DQ3A} + I_{DQ4A} = 350\ mA$, unless otherwise noted. Adjust $V_{GG} = V_{GG12A} = V_{GG34A}$ from $-1.5\ V$ to $0\ V$ to achieve the desired I_{DQ} . Typical $V_{GG} = -0.5\ V$ for $I_{DQ} = 350\ mA$.

Table 1.

Parameter	Symbol	Min	Typ	Max	Unit	Test Conditions/Comments
FREQUENCY RANGE		50		70	GHz	
GAIN		12.5	14.5		dB	
Gain Variation over Temperature			0.02		dB/°C	
RETURN LOSS						
Input	S11		22		dB	
Output	S22		19		dB	
OUTPUT						
Output Power for 1 dB Compression	P1dB	15.5	17		dBm	Output power (P_{OUT}) per tone = 0 dBm with 1 MHz tone spacing
Saturated Output Power	P_{SAT}		21		dBm	
Output Third-Order Intercept	OIP3		25.5		dBm	
INPUT						
Input Third-Order Intercept	IIP3		11.5		dBm	P_{OUT} per tone = 0 dBm with 1 MHz tone spacing
SUPPLY						
Current	I_{DQ}		350	400	mA	Adjust V_{GG} to achieve $I_{DQ} = 350\ mA$ typical
Voltage	V_{DD}	1.5	3.5	4.0	V	

70 GHz TO 90 GHz FREQUENCY RANGE

$T_{DIE\ BOTTOM} = 25^{\circ}C$, $V_{DD} = V_{DD1A} = V_{DD2A} = V_{DD3A} = V_{DD4A} = 3.5\ V$ and $I_{DQ} = I_{DQ1A} + I_{DQ2A} + I_{DQ3A} + I_{DQ4A} = 350\ mA$, unless otherwise noted. Adjust $V_{GG} = V_{GG12A} = V_{GG34A}$ from $-1.5\ V$ to $0\ V$ to achieve the desired I_{DQ} . Typical $V_{GG} = -0.5\ V$ for $I_{DQ} = 350\ mA$.

Table 2.

Parameter	Symbol	Min	Typ	Max	Unit	Test Conditions/Comments
FREQUENCY RANGE		70		90	GHz	
GAIN		12	14		dB	
Gain Variation over Temperature			0.02		dB/°C	
RETURN LOSS						
Input	S11		18		dB	
Output	S22		13		dB	
OUTPUT						
Output Power for 1 dB Compression	P1dB	16	17.5		dBm	P_{OUT} per tone = 0 dBm with 1 MHz tone spacing
Saturated Output Power	P_{SAT}		21		dBm	
Output Third-Order Intercept	OIP3		25		dBm	
INPUT						
Input Third-Order Intercept	IIP3		11		dBm	P_{OUT} per tone = 0 dBm with 1 MHz tone spacing
SUPPLY						
Current	I_{DQ}		350	400	mA	Adjust V_{GG} to achieve $I_{DQ} = 350\ mA$ typical
Voltage	V_{DD}	1.5	3.5	4.0	V	

90 GHz TO 95 GHz FREQUENCY RANGE

$T_{DIE\ BOTTOM} = 25^{\circ}C$, $V_{DD} = V_{DD1A} = V_{DD2A} = V_{DD3A} = V_{DD4A} = 3.5\ V$, and $I_{DQ} = I_{DQ1A} + I_{DQ2A} + I_{DQ3A} + I_{DQ4A} = 350\ mA$, unless otherwise noted. Adjust $V_{GG} = V_{GG12A} = V_{GG34A}$ from $-1.5\ V$ to $0\ V$ to achieve the desired I_{DQ} . Typical $V_{GG} = -0.5\ V$ for $I_{DQ} = 350\ mA$.

Table 3.

Parameter	Symbol	Min	Typ	Max	Unit	Test Conditions/Comments
FREQUENCY RANGE		90		95	GHz	
GAIN			15		dB	
Gain Variation over Temperature			0.02		dB/°C	
RETURN LOSS						
Input	S11		15		dB	
Output	S22		12		dB	
SUPPLY						
Current	I_{DQ}		350	400	mA	Adjust V_{GG} to achieve $I_{DQ} = 350\ mA$ typical
Voltage	V_{DD}	1.5	3.5	4.0	V	

ABSOLUTE MAXIMUM RATINGS

Table 4.

Parameter	Rating
Drain Bias Voltage (V_{DD})	4.5 V
Gate Bias Voltage (V_{GG})	-2 V to 0 V dc
Radio Frequency (RF) Input Power (RFIN)	17 dBm
Continuous Power Dissipation (P_{DISS} , at $T_{DIE\ BOTTOM} = 85^{\circ}C$ (Derate 26.95 mW/ $^{\circ}C$ Above 85 $^{\circ}C$)	2.4 W
Storage Temperature Range (Ambient)	-65 $^{\circ}C$ to +150 $^{\circ}C$
Operating Temperature Range (Die Bottom)	-55 $^{\circ}C$ to +85 $^{\circ}C$
ESD Sensitivity	
Human Body Model (HBM)	Class 0 125 V
Channel Temperature to Maintain 1 Million Hour Mean Time to Failure (MTTF)	175 $^{\circ}C$
Nominal Channel Temperature at $T_{DIE\ BOTTOM} = 85^{\circ}C$, $V_{DD} = 3.5\ V$	130.4 $^{\circ}C$

Stresses at or above those listed under Absolute Maximum Ratings may cause permanent damage to the product. This is a stress rating only; functional operation of the product at these or any other conditions above those indicated in the operational section of this specification is not implied. Operation beyond the maximum operating conditions for extended periods may affect product reliability.

THERMAL RESISTANCE

Thermal performance is directly linked to printed circuit board (PCB) design and operating environment. Careful attention to PCB thermal design is required. θ_{JC} is the junction-to-case thermal resistance.

Table 5. Thermal Resistance

Package Type	θ_{JC}	Unit
C-16-2	37.1	$^{\circ}C/W$

ESD CAUTION



ESD (electrostatic discharge) sensitive device. Charged devices and circuit boards can discharge without detection. Although this product features patented or proprietary protection circuitry, damage may occur on devices subjected to high energy ESD. Therefore, proper ESD precautions should be taken to avoid performance degradation or loss of functionality.

PIN CONFIGURATION AND FUNCTION DESCRIPTIONS

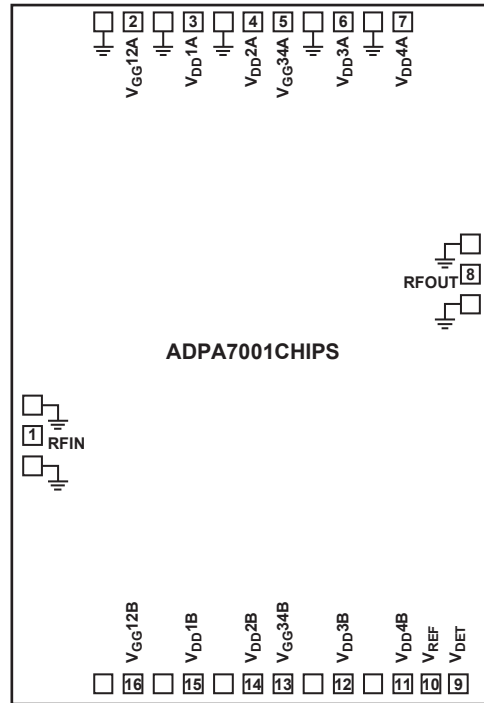

Figure 2. Pad Configuration

Table 6. Pad Function Descriptions

Pad No.	Mnemonic	Description
1	RFIN	RF Input. This pad is ac-coupled and matched to 50 Ω . See Figure 3 for the interface schematic.
2	V _{GG12A}	Gate Control Pad for the First and Second Stage Amplifiers. See Figure 4 for the interface schematic.
3, 4	V _{DD1A} , V _{DD2A}	Drain Bias Voltage Pads for the First and Second Stage Amplifiers. External bypass capacitors of 100 pF, 0.1 μ F, and 4.7 μ F are required on these pads. Connect these pads to a 3.5 V supply. See Figure 5 for the interface schematic.
5	V _{GG34A}	Gate Control Pad for the Third and Fourth Stage Amplifiers. See Figure 4 for the interface schematic.
6, 7	V _{DD3A} , V _{DD4A}	Drain Bias Voltage Pads for the Third and Fourth Stage Amplifiers. External bypass capacitors of 100 pF, 0.1 μ F, and 4.7 μ F are required on these pads. Connect these pads to a 3.5 V supply. See Figure 5 for the interface schematic.
8	RFOUT	RF Output. This pad is ac-coupled and matched to 50 Ω . See Figure 9 for the interface schematic.
9	V _{DET}	DC Voltage Representing the RF Output Power. This pad is rectified by the diode that is biased through an external resistor. See Figure 9 for the interface schematic.
10	V _{REF}	DC Voltage of the Diode. This pad is biased through an external detector circuit used for temperature compensation of V _{DET} . See Figure 10 for the interface schematic.
11, 12	V _{DD4B} , V _{DD3B}	Drain Bias Voltage Pads for the Fourth and Third Stage Alternative Bias Configuration. External bypass capacitors of 100 pF, 0.1 μ F, and 4.7 μ F are required. See Figure 7 for the interface schematic.
13	V _{GG34B}	Gate Control Pad for the Third and Fourth Stage Alternative Bias Configuration. Coupling capacitors are required. See Figure 8 for the interface schematic.
14, 15	V _{DD2B} , V _{DD1B}	Drain Bias Voltage Pads for the Second and First Stage Alternative Bias Configuration. External bypass capacitors of 100 pF, 0.1 μ F, and 4.7 μ F are required. See Figure 7 for the interface schematic.
16	V _{GG12B}	Gate Control Pad for the First and Second Stage Alternative Bias Configuration. Coupling capacitors are required. See Figure 8 for the interface schematic.
Die Bottom	GND	Ground. Die bottom must be connected to RF/dc ground. See Figure 6 for the interface schematic.

INTERFACE SCHEMATICS

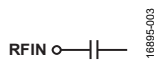

Figure 3. RFIN Interface Schematic

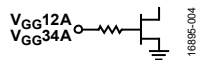

Figure 4. V_{GG12A} and V_{GG34A} Interface Schematic

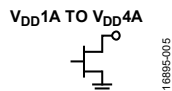

Figure 5. V_{DD1A} to V_{DD4A} Interface Schematic



Figure 6. GND Interface Schematic

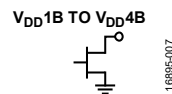

Figure 7. V_{DD1B} to V_{DD4B} Interface Schematic

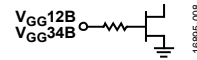

Figure 8. V_{GG12B} and V_{GG34B} Interface Schematic

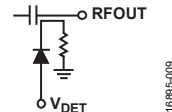

Figure 9. RFOUT and V_{DET} Interface Schematic



Figure 10. V_{REF} Interface Schematic

TYPICAL PERFORMANCE CHARACTERISTICS

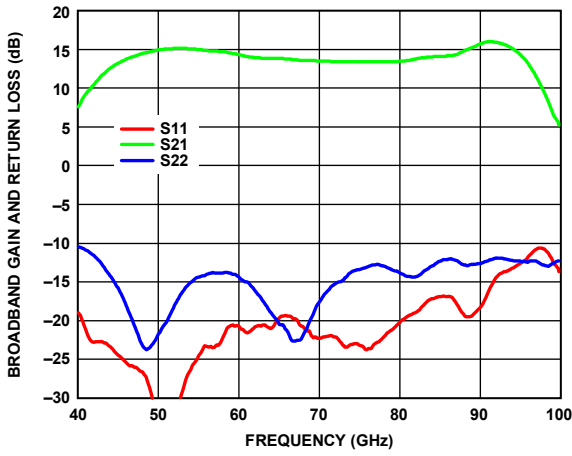

Figure 11. Broadband Gain and Return Loss vs. Frequency

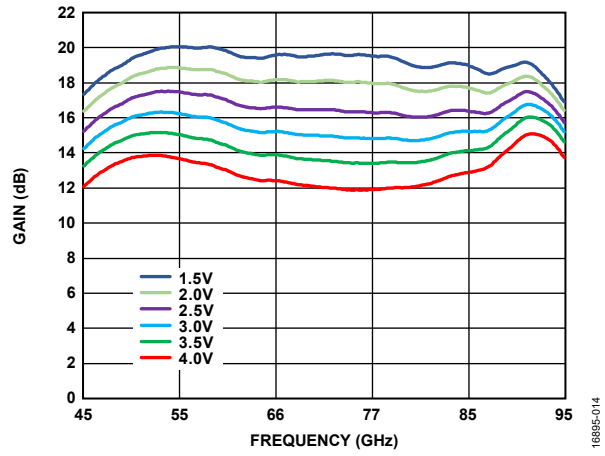

Figure 14. Gain vs. Frequency for Various V_{DD} Values

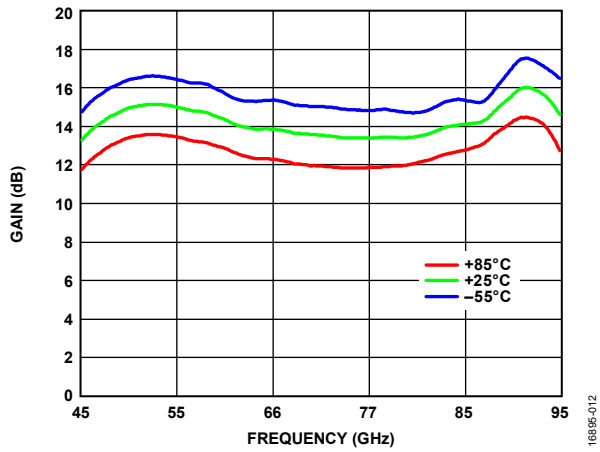

Figure 12. Gain vs. Frequency for Various Temperatures

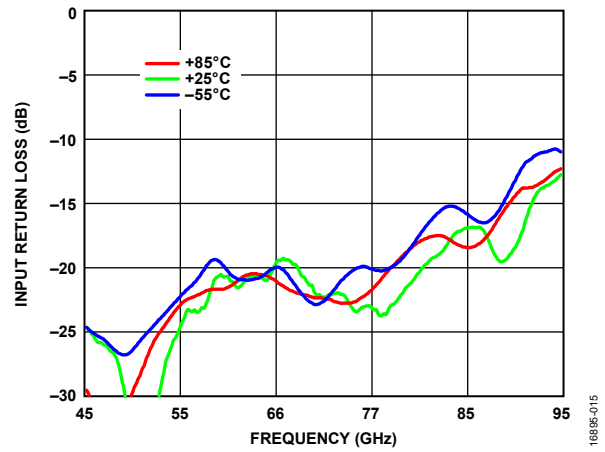

Figure 15. Input Return Loss vs. Frequency at Various Temperatures

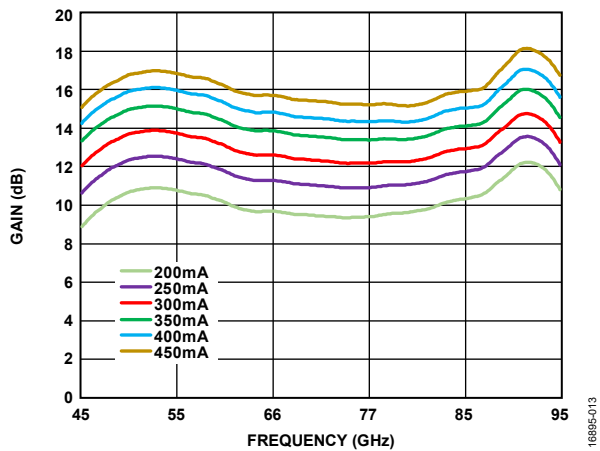

Figure 13. Gain vs. Frequency for Various I_{DQ} Values

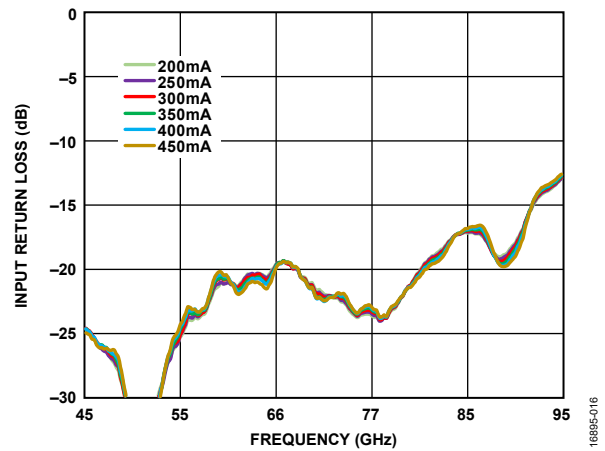

Figure 16. Input Return Loss vs. Frequency for Various I_{DQ} Values

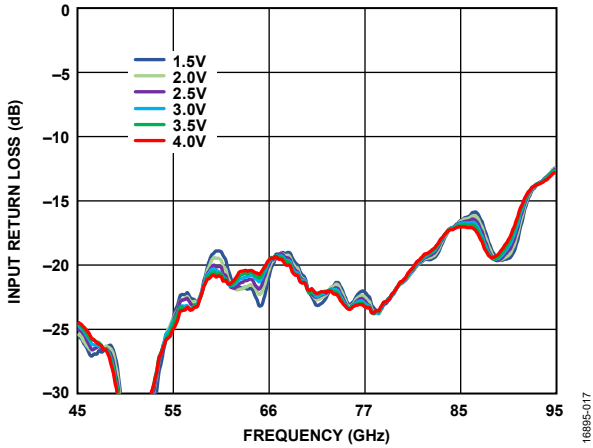

Figure 17. Input Return Loss vs. Frequency for Various V_{DD} Values

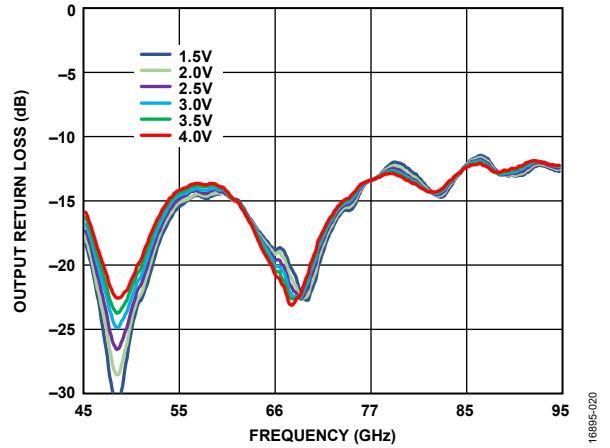

Figure 20. Output Return Loss vs. Frequency for Various V_{DD} Values

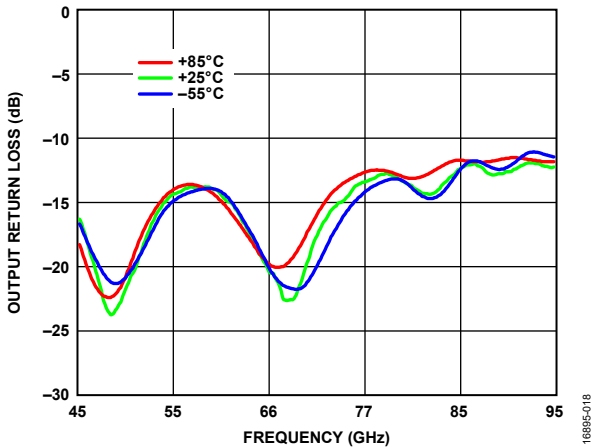

Figure 18. Output Return Loss vs. Frequency at Various Temperatures

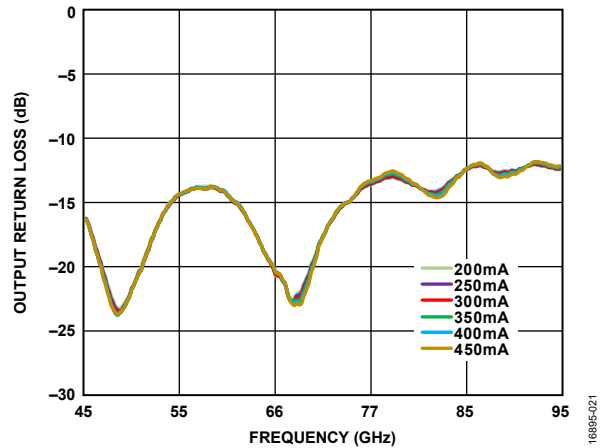

Figure 21. Output Return Loss vs. Frequency for Various I_{DQ} Values

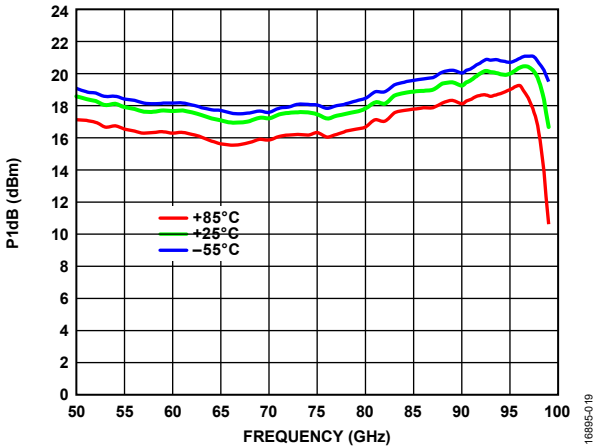

Figure 19. P_{1dB} vs. Frequency at Various Temperatures

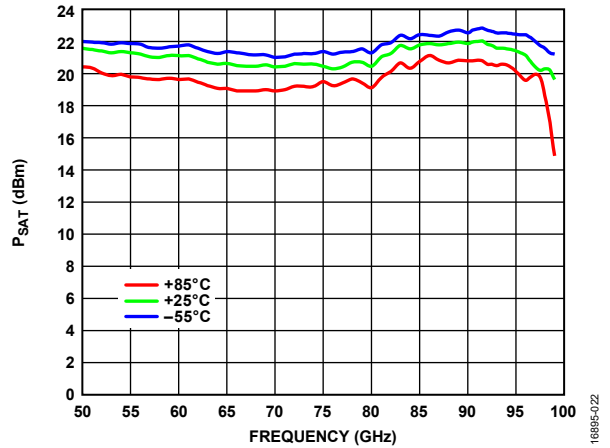

Figure 22. P_{SAT} vs. Frequency at Various Temperatures

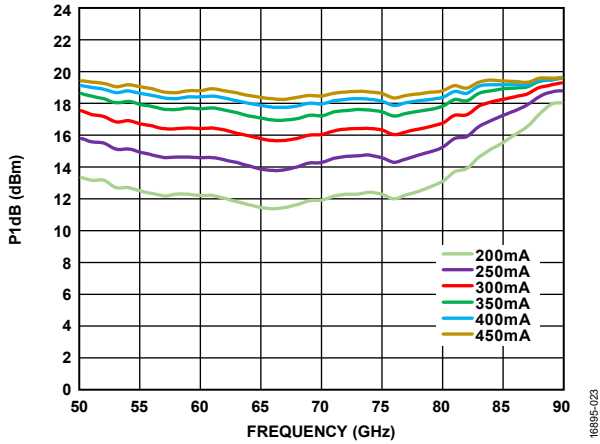

Figure 23. P1dB vs. Frequency for Various I_{DQ} Values

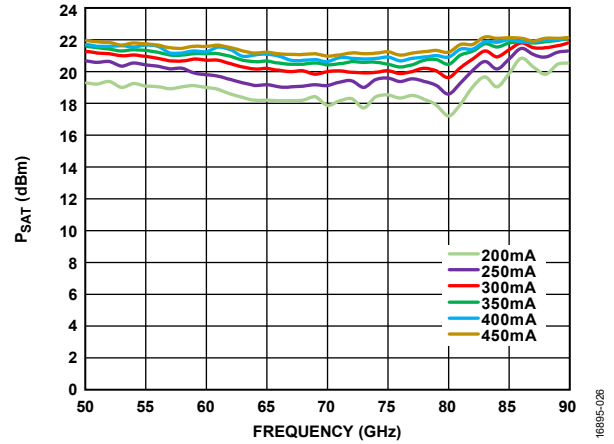

Figure 26. P_{SAT} vs. Frequency for Various I_{DQ} Values

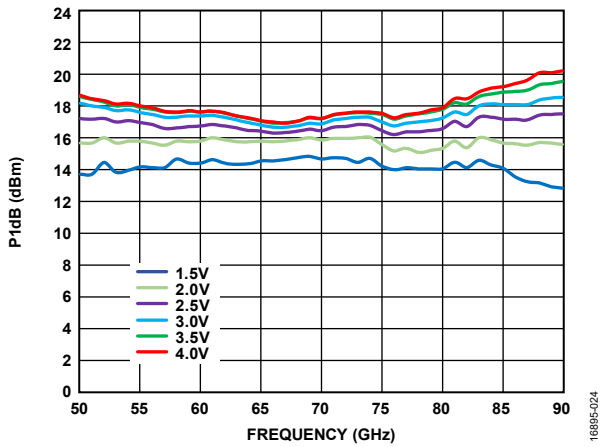

Figure 24. P1dB vs. Frequency for Various V_{DD} Values

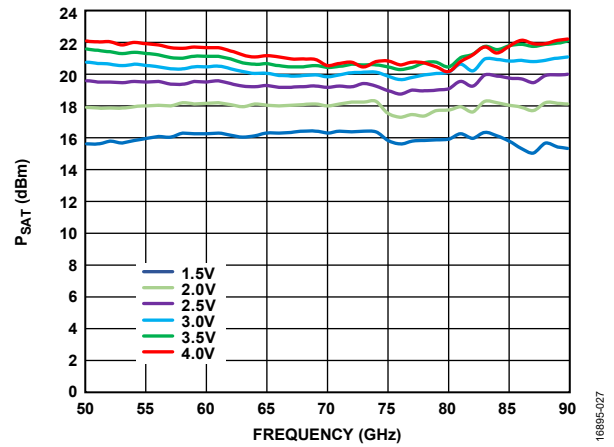

Figure 27. P_{SAT} vs. Frequency for Various V_{DD} Values

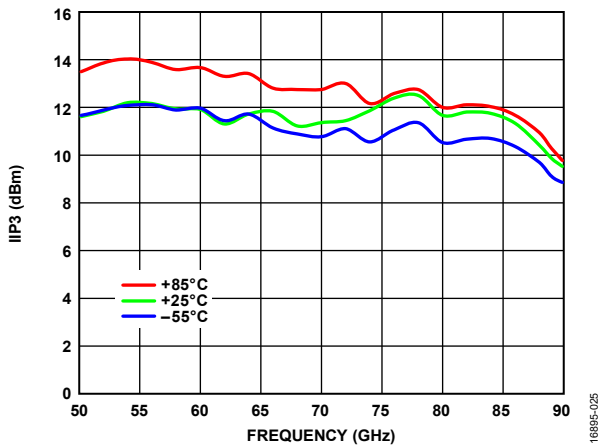

Figure 25. IIP3 vs. Frequency at Various Temperatures

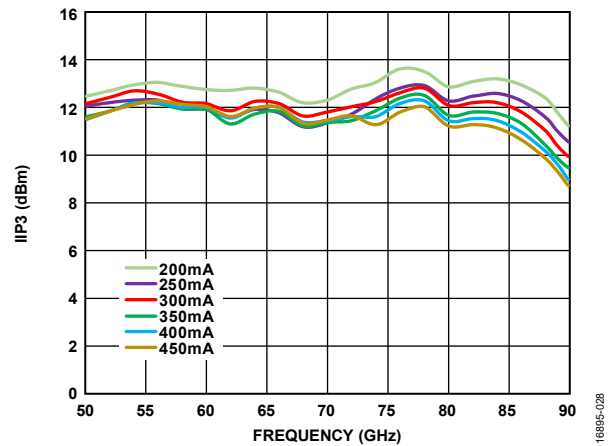

Figure 28. IIP3 vs. Frequency for Various I_{DQ} Values

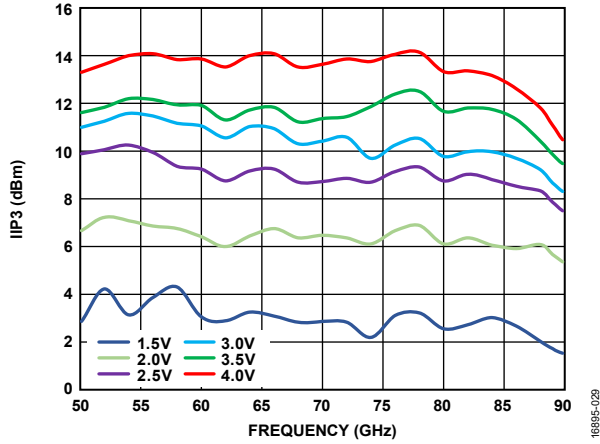

Figure 29. IIP3 vs. Frequency for Various V_{DD} Values

16895-029

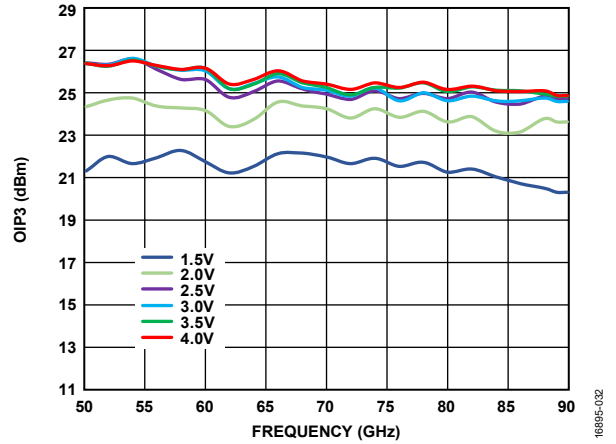

Figure 32. OIP3 vs. Frequency for Various V_{DD} Values

16895-032

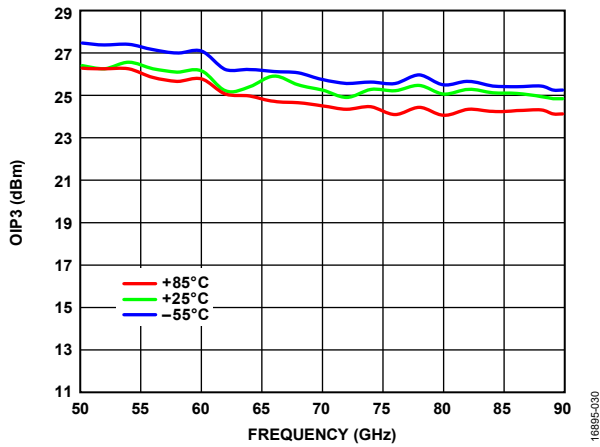

Figure 30. OIP3 vs. Frequency at Various Temperatures

16895-030

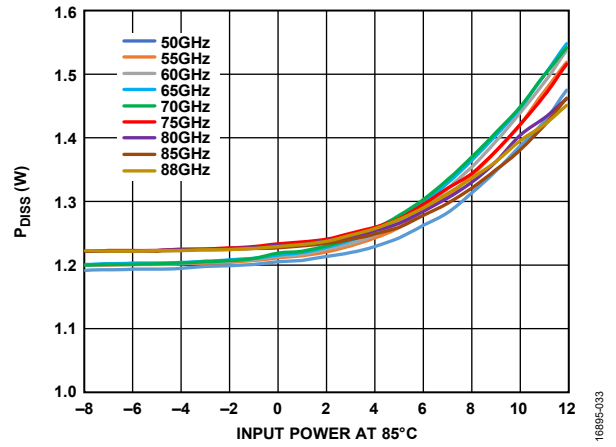

Figure 33. P_{Diss} vs. Input Power at 85°C for Various Frequencies

16895-033

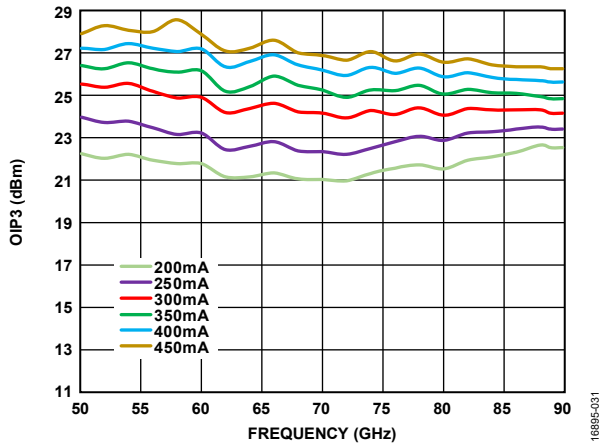

Figure 31. OIP3 vs. Frequency for Various I_{DQ} Values

16895-031

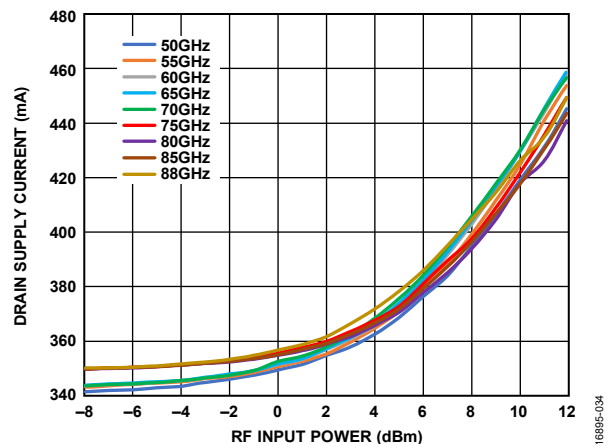

Figure 34. Drain Supply Current vs. RF Input Power for Various Frequencies

16895-034

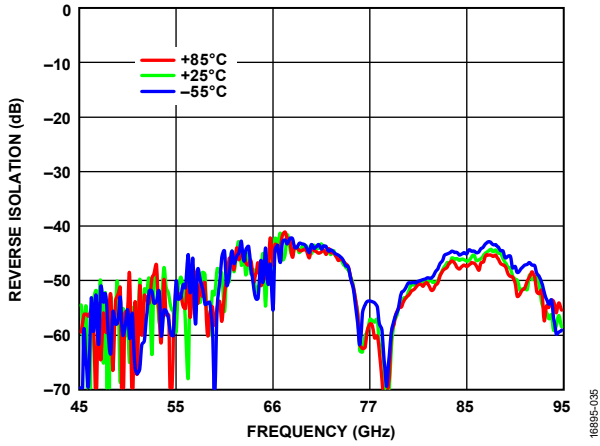

Figure 35. Reverse Isolation vs. Frequency at Various Temperatures

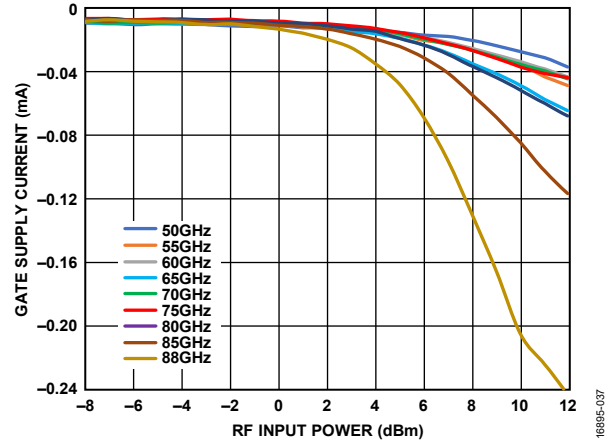

Figure 37. Gate Supply Current vs. RF Input Power

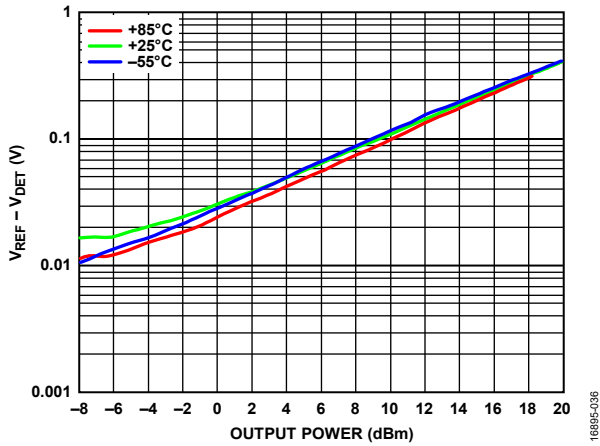

Figure 36. Detector Voltage ($V_{REF} - V_{DET}$) vs. Output Power for Various Temperatures at 70 GHz

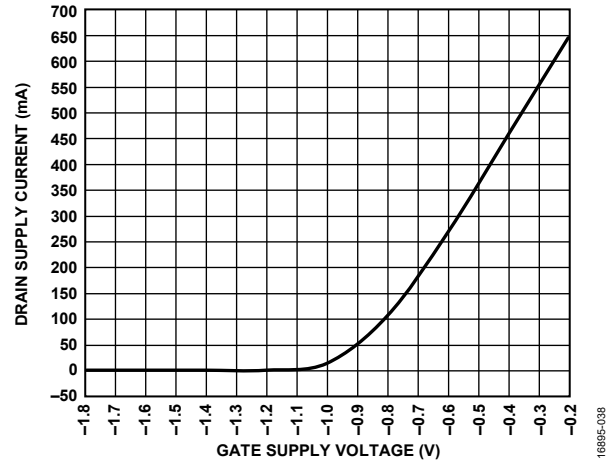

Figure 38. Drain Supply Current vs. Gate Supply Voltage

THEORY OF OPERATION

The architecture of the ADPA7001CHIPS medium power amplifier is shown in Figure 39. The ADPA7001CHIPS uses four cascaded, four-stage amplifiers operating in quadrature between six 90° hybrids.

The input signal is divided evenly into two. Then, each signal is again divided into two, and each of these paths is amplified through four independent gain stages. Then, the amplified signals are combined at the output. This balanced amplifier approach forms an amplifier with a combined gain of 14 dB and a P_{SAT} value of 21 dBm.

A portion of the RF output signal is directionally coupled to a diode for detection of the RF output power. When the diode is dc biased, it rectifies the RF power and makes it available for measurement as a dc voltage at V_{DET} . To allow temperature compensation of V_{DET} , an identical and symmetrically located circuit, minus the coupled RF power, is available via V_{REF} . Taking the difference of $V_{REF} - V_{DET}$ provides a temperature compensated signal that is proportional to the RF output. (see Figure 36).

The 90° hybrids ensure that the input and output return losses are greater than or equal to 15 dB and 12 dB, respectively. See the application circuits shown in Figure 43 and Figure 44 for further details on biasing the various blocks.

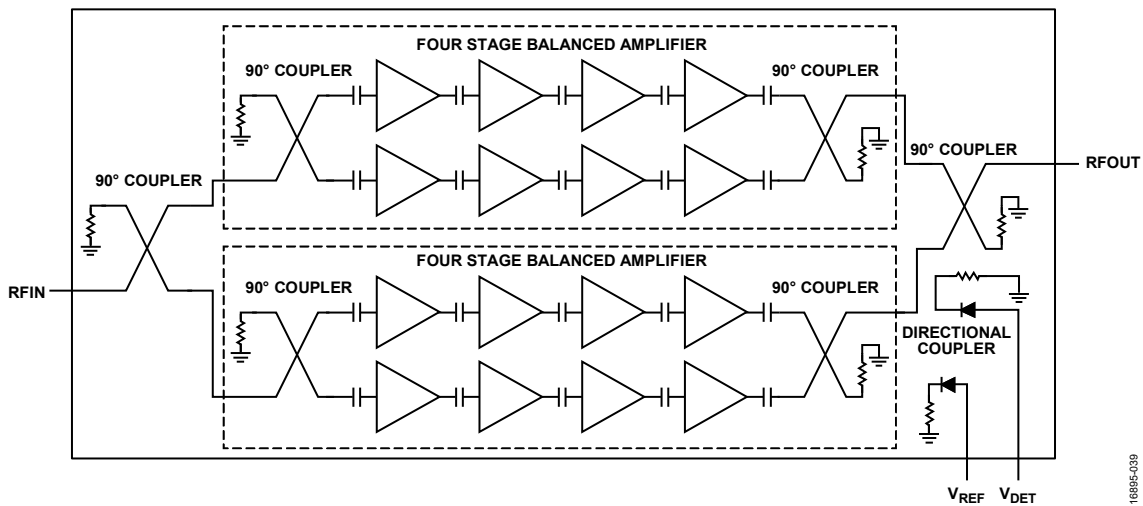

Figure 39. ADPA7001CHIPS Architecture

16895-039

APPLICATIONS INFORMATION

The ADPA7001CHIPS is a GaAs, pHEMT, MMIC power amplifier. Capacitive bypassing is required for V_{DD1A} through V_{DD4A} and V_{DD1B} through V_{DD4B} (see Figure 43). V_{GG12A} is the gate bias pad for the first and second gain stages. V_{GG34A} is the gate bias pad for the third and fourth gain stages. Apply a gate bias voltage to V_{GG12A} and V_{GG34A} , and use capacitive bypassing as shown in Figure 43.

All measurements for this device were taken using the typical application circuit (see Figure 43) and configured as shown in the assembly diagram (Figure 45).

The following is the recommended bias sequence during power-up:

1. Connect GND to RF/dc ground.
2. Set the gate bias voltage to -1.5 V.
3. Set all the drain bias voltages, $V_{DD} = 3.5$ V.
4. Increase the gate bias voltage to achieve a quiescent current, $I_{DQ} = 350$ mA.
5. Apply the RF signal.

The following is the recommended bias sequence during power-down:

1. Turn off the RF signal.
2. Decrease the gate bias voltage to -1.5 V to achieve $I_{DQ} = 0$ mA (approximately).
3. Decrease all of the drain bias voltages to 0 V.
4. Increase the gate bias voltage to 0 V.

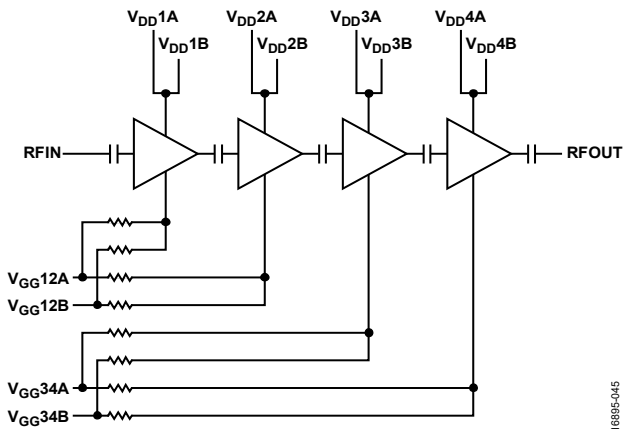

Figure 40. Simplified Block Diagram

Simplified bias pad connections to dedicated gain stages and dependence and independence among pads are shown in Figure 40.

Table 7. Power Selection Table^{1,2}

I_{DQ} (mA)	Gain (dB)	P1dB (dBm)	OIP3 (dBm)	P_{DISS} (mW)	V_{GG} (V)
200	10	11	22	700	-0.64
250	11.5	13.5	23	875	-0.59
300	13	15.5	24	1050	-0.54
350	14	16.5	25	1225	-0.48
400	15	17.5	26	1400	-0.44
450	16	18	27	1575	-0.39

¹ Data taken at the following nominal bias conditions: $V_{DD} = 3.5$ V, $T = 25^\circ\text{C}$.

² Adjust V_{GG12A} and V_{GG34A} from -1.5 V to 0 V to achieve the desired drain current.

The $V_{DD} = 3.5$ V and $I_{DD} = 350$ mA bias conditions are recommended to optimize overall performance. Unless otherwise noted, the data shown was taken using the recommended bias conditions. Operation of the ADPA7001CHIPS at different bias conditions may provide performance that differs from what is shown in Table 1 and Table 2. Biasing the ADPA7001CHIPS for higher drain current typically results in higher P1dB, output IP3, and gain at the expense of increased power consumption (see Table 7).

MOUNTING AND BONDING TECHNIQUES FOR MILLIMETERWAVE GaAs MMICs

Attach the die directly to the ground plane with conductive epoxy (see the Handling Precautions section, the Mounting section, and the Wire Bonding section).

Microstrip, $50\ \Omega$ transmission lines on 0.127 mm (5 mil) thick alumina, thin film substrates are recommended for bringing the radio frequency to and from the chip. Raise the die 0.075 mm (3 mil) to ensure that the surface of the die is coplanar with the surface of the substrate.

Place microstrip substrates as close to the die as possible to minimize ribbon bond length. Typical die to substrate spacing is 0.076 mm to 0.152 mm (3 mil to 6 mil). To ensure wideband matching, a 15 fF capacitive stub is recommended on the PCB board before the ribbon bond.

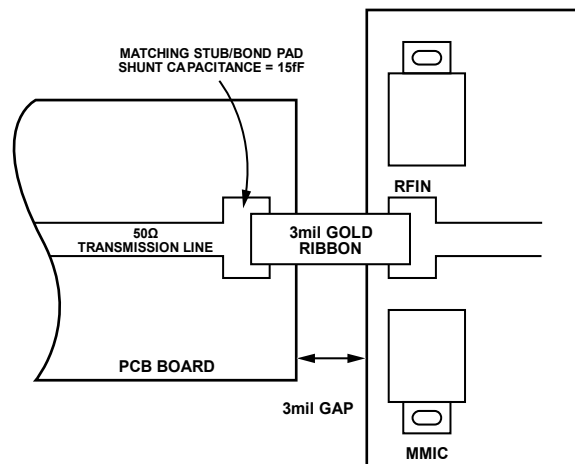

Figure 41. High Frequency Input Wideband Matching

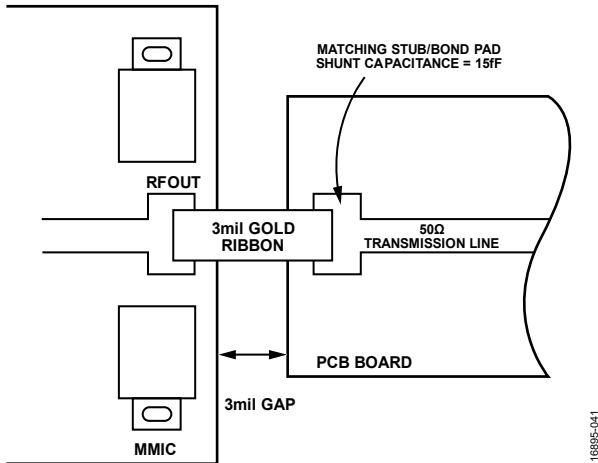

Figure 42. High Frequency Output Wideband Matching

Place microstrip substrates as close to the die as possible to minimize bond wire length. Typical die to substrate spacing is 0.076 mm to 0.152 mm (3 mil to 6 mil).

Handling Precautions

To avoid permanent damage, follow these storage, cleanliness, static sensitivity, transient, and general handling precautions:

- Place all bare die in either waffle or gel-based ESD protective containers and then seal the die in an ESD protective bag for shipment. After the sealed ESD protective bag is opened, store all die in a dry nitrogen environment.

- Handle the chips in a clean environment. Do not attempt to clean the chip using liquid cleaning systems.
- Follow ESD precautions to protect against ESD strikes.
- While bias is applied, suppress instrument and bias supply transients. Use shielded signal and bias cables to minimize inductive pickup.
- Handle the chip along the edges with a vacuum collet or with a sharp pair of tweezers. The surface of the chip have fragile air bridges and must not be touched with vacuum collet, tweezers, or fingers.

Mounting

Before epoxy die is attached, apply a minimum amount of epoxy to the mounting surface so that a thin epoxy fillet is observed around the perimeter of the chip after it is placed into position. Cure the epoxy per the schedule of the manufacturer.

Wire Bonding

RF bonds made with 0.003 in. × 0.0005 in. gold ribbon are recommended for the RF ports. These bonds must be thermosonically bonded with a force of 40 g to 60 g. DC bonds of 0.001 in. (0.025 mm) diameter, thermosonically bonded, are recommended. Create ball bonds with a force of 40 g to 50 g and wedge bonds with a force of 18 g to 22 g. Create all bonds with a nominal stage temperature of 150°C. Apply a minimum amount of ultrasonic energy to achieve reliable bonds. Keep all bonds as short as possible, less than 12 mil (0.31 mm).

Alternatively, short (≤ 3 mil) RF bonds made with two 1 mil wires can be used.

TYPICAL APPLICATION CIRCUIT

The drain and gate voltages can be applied to either the north or the south side of the circuit.

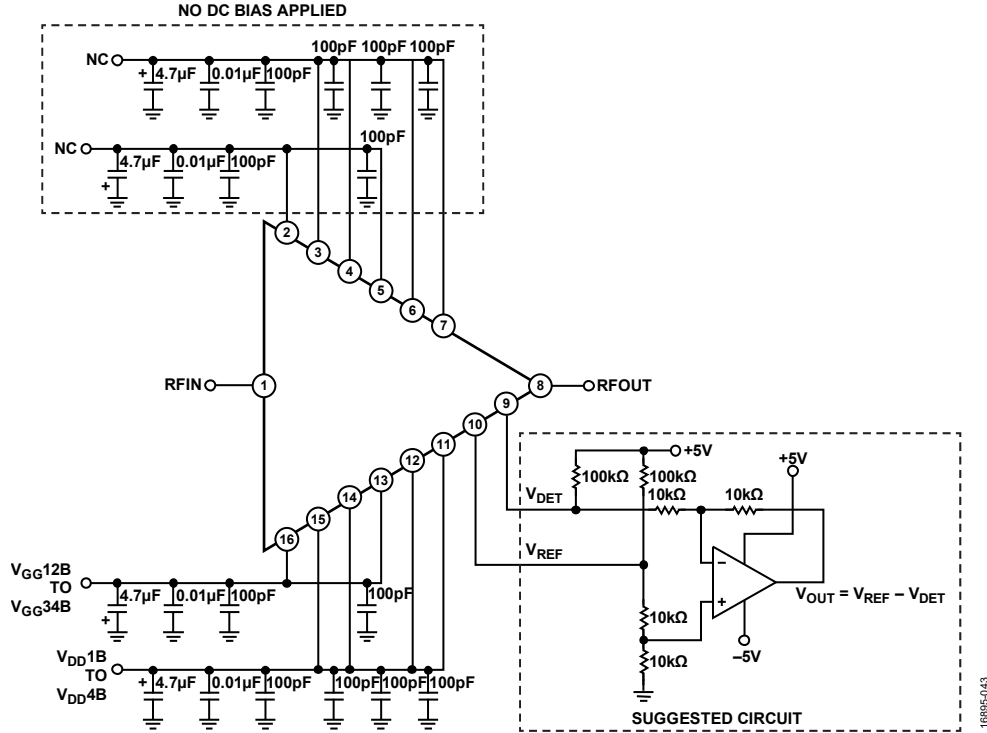

Figure 43. Application Circuit

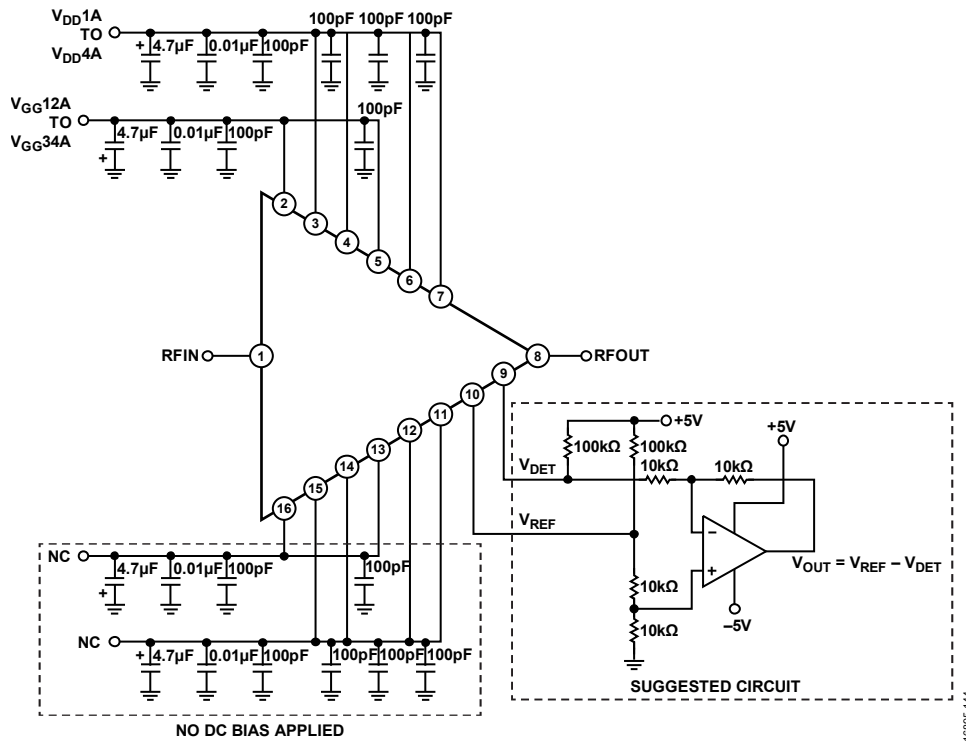

Figure 44. Alternate Application Circuit

ASSEMBLY DIAGRAM

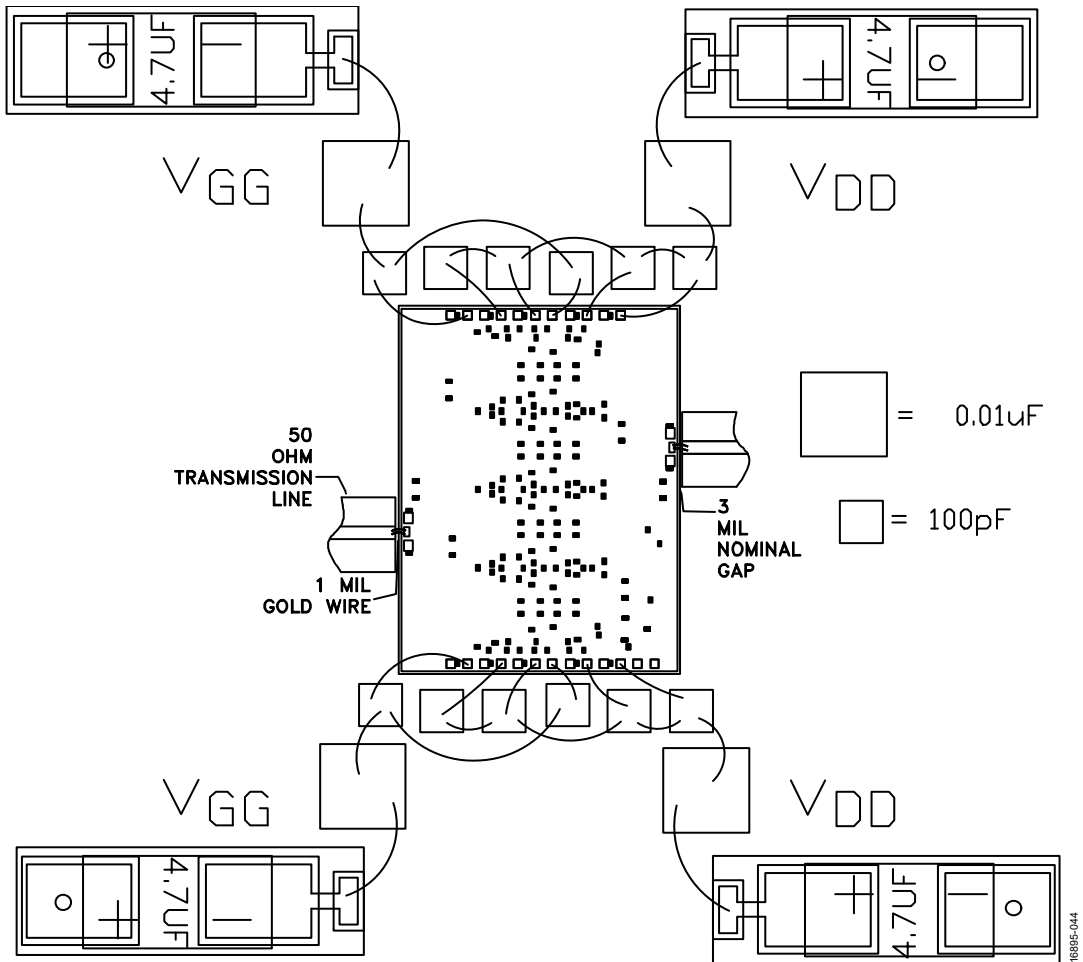
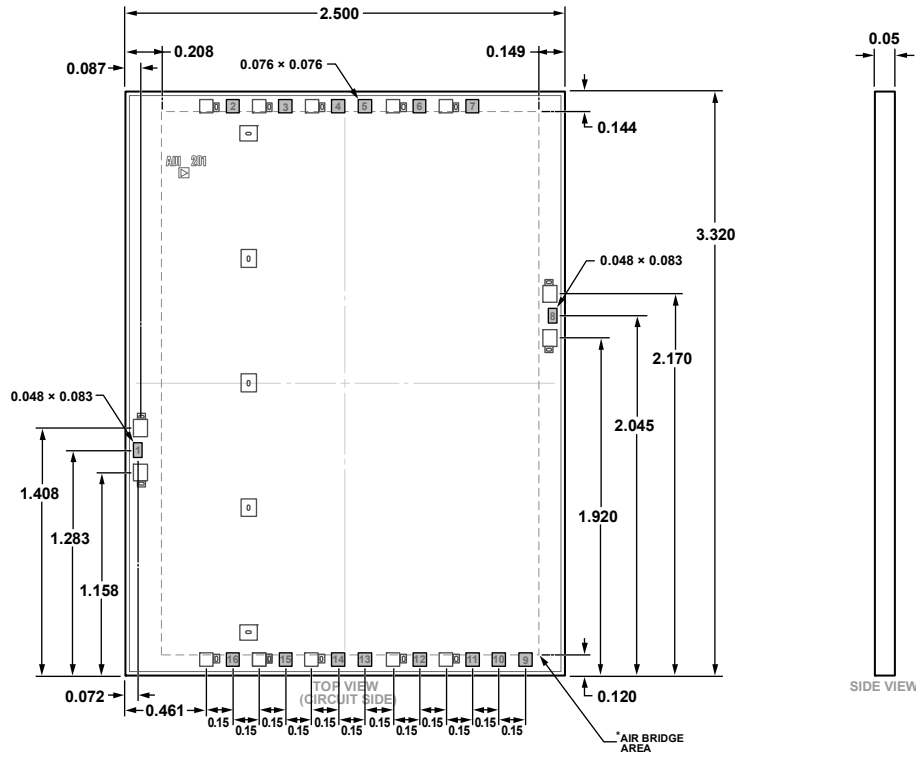

Figure 45. Assembly Diagram

OUTLINE DIMENSIONS



*This die utilizes fragile air bridges. Any pickup tools used must not contact this area.

Figure 46. 16-Pad Bare Die [CHIP]
(C-16-2)
Dimensions shown in millimeters

07-30-2018-A

ORDERING GUIDE

Model	Temperature Range	Package Description	Package Option
ADPA7001CHIPS	-55°C to +85°C	16-Pad Bare Die [CHIP]	C-16-2
ADPA7001CHIPS-SX	-55°C to +85°C	16-Pad Bare Die [CHIP]	C-16-2

Компания «Океан Электроники» предлагает заключение долгосрочных отношений при поставках импортных электронных компонентов на взаимовыгодных условиях!

Наши преимущества:

- Поставка оригинальных импортных электронных компонентов напрямую с производств Америки, Европы и Азии, а так же с крупнейших складов мира;
- Широкая линейка поставок активных и пассивных импортных электронных компонентов (более 30 млн. наименований);
- Поставка сложных, дефицитных, либо снятых с производства позиций;
- Оперативные сроки поставки под заказ (от 5 рабочих дней);
- Экспресс доставка в любую точку России;
- Помощь Конструкторского Отдела и консультации квалифицированных инженеров;
- Техническая поддержка проекта, помощь в подборе аналогов, поставка прототипов;
- Поставка электронных компонентов под контролем ВП;
- Система менеджмента качества сертифицирована по Международному стандарту ISO 9001;
- При необходимости вся продукция военного и аэрокосмического назначения проходит испытания и сертификацию в лаборатории (по согласованию с заказчиком);
- Поставка специализированных компонентов военного и аэрокосмического уровня качества (Xilinx, Altera, Analog Devices, Intersil, Interpoint, Microsemi, Actel, Aeroflex, Peregrine, VPT, Syfer, Eurofarad, Texas Instruments, MS Kennedy, Miteq, Cobham, E2V, MA-COM, Hittite, Mini-Circuits, General Dynamics и др.);

Компания «Океан Электроники» является официальным дистрибьютором и эксклюзивным представителем в России одного из крупнейших производителей разъемов военного и аэрокосмического назначения «JONHON», а так же официальным дистрибьютором и эксклюзивным представителем в России производителя высокотехнологичных и надежных решений для передачи СВЧ сигналов «FORSTAR».



JONHON

«JONHON» (основан в 1970 г.)

Разъемы специального, военного и аэрокосмического назначения:

(Применяются в военной, авиационной, аэрокосмической, морской, железнодорожной, горно- и нефтедобывающей отраслях промышленности)

«FORSTAR» (основан в 1998 г.)

ВЧ соединители, коаксиальные кабели,
кабельные сборки и микроволновые компоненты:

(Применяются в телекоммуникациях гражданского и специального назначения, в средствах связи, РЛС, а так же военной, авиационной и аэрокосмической отраслях промышленности).



Телефон: 8 (812) 309-75-97 (многоканальный)

Факс: 8 (812) 320-03-32

Электронная почта: ocean@oceanchips.ru

Web: <http://oceanchips.ru/>

Адрес: 198099, г. Санкт-Петербург, ул. Калинина, д. 2, корп. 4, лит. А