

Tall height (4.3mm and 5.0mm) and surface mount type

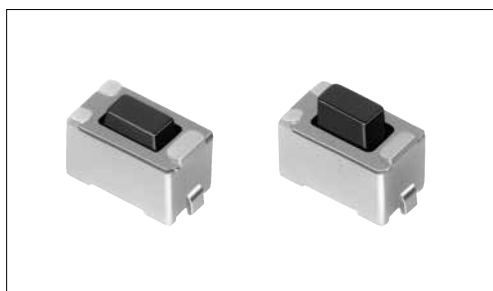

Typical Specifications



Items	Specifications
Rating (max.)	50mA 12V DC
Rating (min.)	10 μ A 1V DC
Initial contact resistance	500m Ω max.
Travel (mm)	0.25

Product Line

Product No.	Operating force	Operating direction	Operating life (5mA 5V DC)	Stem color	Height	Minimum order unit (pcs.)	
						Japan	Export
SKQBAE010	0.98N	Top push	50,000 cycles	Black	h=4.3mm	2,000	2,000
SKQMASE010	1.57N			Red			
SKQMAQE010	2.55N		Black	h=5mm			
SKQMATE010	0.98N		Red				
SKQMBBE010	1.57N		Black				
SKQMARE010	2.55N		Red				

Packing Specifications

Taping

Number of packages (pcs.)			Tape width (mm)	Export package measurements (mm)
1 reel	1 case / Japan	1 case / export packing		
2,000	20,000	20,000	12	395×395×205

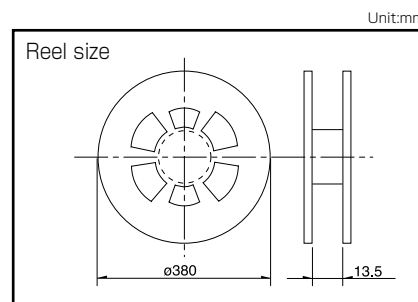

Note

For reels of 330mm diameter, please inquire.







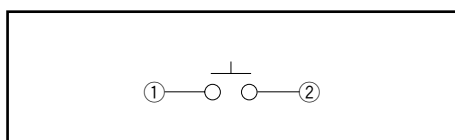









Dimensions

Style	PC board land dimensions (Viewed from switch mounting face)

Circuit Diagram



Refer to P.249 for soldering conditions.

Type		Sharp Feeling Type							
		Surface Mount							
Series		SKRK	SKTH	SKRP	SKQM	SKQY	SKTQ	SKTR	SKSU
Photo									
Features		Compact size Low-profile	Compact size	High operation force Compact size	Compact size		Middle travel		
Water-proof		—	—	—	—	—	—	—	●
Dust-proof		—	●	—	—	—	—	—	●
IP standard		—	—	—	—	—	—	—	67 equivalent
Operating direction	Top push	●	●	●	●	●	●	●	●
	Side push	—	—	—	—	—	—	—	—
Dimensions (mm)	W	3.9	3.5	4.2	6	6.1	5.3	□6.1	5.3
	D	2.9	3.2		3.5	3.7	5.4		5.4
	H	1.5/2	1.8/2.5	2.5	4.3/5	2.5	4.25	4.1	3.85/4.34
Operation force coverage	1N max.	↕	↕	↕	↕	↕	↕	↕	↕
	1N to 2N								
	2N to 3N								
	3N to 4N								
4N to 5N									
Travel (mm)		0.13	0.12	0.2	0.25		0.71	0.72	0.7/0.9
Ground terminal		—	—	—	—	○	—	—	—
Operating temperature range		-40°C to +85°C			-40°C to +90°C				
Automotive use		—	●	●	●	●	●	●	●
Life Cycle									
Electrical performance	Rating (max.) (Resistive load)	50mA 12V DC	25mA 16V DC	50mA 16V DC	50mA 12V DC		50mA 16V DC		
	Rating (min.) (Resistive load)	10μA 1V DC							
	Insulation resistance	100MΩ min. 100V DC 1min.							
	Voltage proof	250V AC 1min.	100V AC 1min.	250V AC 1min.					
Durability	Vibration	10 to 55 to 10Hz/min., the amplitude is 1.5mm for all the frequencies, in the 3 direction of X, Y and Z for 2 hours respectively							
	Lifetime	Shall be in accordance with individual specifications.							
Environmental performance	Cold	-40°C 96h		-40°C 1,000h	-40°C 96h		-40°C 1,000h		
	Dry heat	90°C 96h		90°C 1,000h	90°C 96h		90°C 1,000h		
	Damp heat	60°C, 90 to 95%RH 96h		60°C, 90 to 95%RH 1,000h	60°C, 90 to 95%RH 96h		60°C, 90 to 95%RH 1,000h		
Page		218	220	222	224	225	227	228	229

W : Width. The most outer dimension excluding terminal portion.
D : Depth. The most outer dimension excluding terminal portion.
H : Height. The minimum dimension if there are variances.

TACT Switch™ Soldering Conditions 249
TACT Switch™ Cautions 250

Notes

- The automotive operating temperature range to be individually discussed upon request.
- Indicates applicability to all products in the series, while ○ indicates applicability to some products in the series.

Condition for Reflow

Available for Surface Mount Type.

Temperature profile



Notes

1. Please confirm the specifications of our product for the detailed condition.
2. Soldering conditions differ depending on reflow soldering machines. Prior verification of soldering condition is highly recommended.

Conditions for Auto-dip

Available for Snap-in Type and Radial Type.

Items	Condition
Flux built-up	Mounting surface should not be exposed to flux
Preheating temperature	Ambient temperature of the soldered surface of PC board. 100°C max.
Preheating time	60s max.
Soldering temperature	260°C max.
Duration of immersion	5s max.
Number of soldering	2times max.

SKHH Series

Items	Condition
Flux built-up	Mounting surface should not be exposed to flux
Preheating temperature	Ambient temperature of the soldered surface of PC board. 110°C max.
Preheating time	60s max.
Soldering temperature	260°C max.
Duration of immersion	5s max.
Number of soldering	2times max.

SKHL Top Push Type, SKQJ Series

Items	Condition
Flux built-up	Mounting surface should not be exposed to flux
Preheating temperature	Ambient temperature of the soldered surface of PC board. 100°C max.
Preheating time	45s max.
Soldering temperature	255°C max.
Duration of immersion	5s max.
Number of soldering	2times max.

Notes

1. Prevent flux penetration from the top side of the TACT Switch™.
2. Switch terminals and a PC board should not be coated with flux prior to soldering.
3. The second soldering should be done after the switch is stable with normal temperature.
4. Use the flux with a specific gravity of min 0.81.
(EC-19S-8 by TAMURA CORPORATION, or equivalents.)

Manual Soldering

Items	Condition
Soldering temperature	350°C max.
Duration of soldering	3s max.
Capacity of soldering iron	60W max.

SKHH, SKHW Series

Items	Condition
Soldering temperature	360°C max.
Duration of soldering	3s max.
Capacity of soldering iron	60W max.

SKTD, SKTG, SKQJ Series

Items	Condition
Soldering temperature	350°C max.
Duration of soldering	3s max.
Capacity of soldering iron	20W max.

Компания «Океан Электроники» предлагает заключение долгосрочных отношений при поставках импортных электронных компонентов на взаимовыгодных условиях!

Наши преимущества:

- Поставка оригинальных импортных электронных компонентов напрямую с производств Америки, Европы и Азии, а так же с крупнейших складов мира;
- Широкая линейка поставок активных и пассивных импортных электронных компонентов (более 30 млн. наименований);
- Поставка сложных, дефицитных, либо снятых с производства позиций;
- Оперативные сроки поставки под заказ (от 5 рабочих дней);
- Экспресс доставка в любую точку России;
- Помощь Конструкторского Отдела и консультации квалифицированных инженеров;
- Техническая поддержка проекта, помощь в подборе аналогов, поставка прототипов;
- Поставка электронных компонентов под контролем ВП;
- Система менеджмента качества сертифицирована по Международному стандарту ISO 9001;
- При необходимости вся продукция военного и аэрокосмического назначения проходит испытания и сертификацию в лаборатории (по согласованию с заказчиком);
- Поставка специализированных компонентов военного и аэрокосмического уровня качества (Xilinx, Altera, Analog Devices, Intersil, Interpoint, Microsemi, Actel, Aeroflex, Peregrine, VPT, Syfer, Eurofarad, Texas Instruments, MS Kennedy, Miteq, Cobham, E2V, MA-COM, Hittite, Mini-Circuits, General Dynamics и др.);

Компания «Океан Электроники» является официальным дистрибьютором и эксклюзивным представителем в России одного из крупнейших производителей разъемов военного и аэрокосмического назначения «JONHON», а так же официальным дистрибьютором и эксклюзивным представителем в России производителя высокотехнологичных и надежных решений для передачи СВЧ сигналов «FORSTAR».



JONHON

«JONHON» (основан в 1970 г.)

Разъемы специального, военного и аэрокосмического назначения:

(Применяются в военной, авиационной, аэрокосмической, морской, железнодорожной, горно- и нефтедобывающей отраслях промышленности)

«FORSTAR» (основан в 1998 г.)

ВЧ соединители, коаксиальные кабели,
кабельные сборки и микроволновые компоненты:

(Применяются в телекоммуникациях гражданского и специального назначения, в средствах связи, РЛС, а так же военной, авиационной и аэрокосмической отраслях промышленности).



Телефон: 8 (812) 309-75-97 (многоканальный)

Факс: 8 (812) 320-03-32

Электронная почта: ocean@oceanchips.ru

Web: <http://oceanchips.ru/>

Адрес: 198099, г. Санкт-Петербург, ул. Калинина, д. 2, корп. 4, лит. А