

42V Quad Monolithic Synchronous Step-Down Regulator

DESCRIPTION

Demonstration circuit 1949A is a quad power supply featuring the **LT[®]8602**. LT8602 is a 42V quad monolithic synchronous step-down regulator. The demo circuit is designed for 5.0V, 3.3V, 1.8V, and 1.2V outputs from a nominal 12V input, with switching frequency set at 2MHz to avoid audio band. The 1.8V and 1.2V converters are powered from the 3.3V output. The 5V, 3.3V are powered from a wide range of 5.5V to 42V. The current capability is 2.5A for the 3.3V output, 1.5A for the 5V output, and 1.8A for the other outputs when running individually. Up to 1A load current can be applied to all the channels simultaneously without special cooling.

Individual soft-start, current limit, input voltage, power good for each output simplify the complex design of quad-output power converters. All regulators are synchronized to a common external clock input or a resistor programmable 250kHz to 2.2MHz internal oscillator. At all frequencies, a 180° phase shift is maintained between 1 and 3, 2 and 4 channels, reducing the input peak current and voltage ripple. Programmable frequency allows optimization between efficiency and external component

size. Each output can be independently disabled using its own TRKSS or RUN pin and be placed in a low quiescent current shutdown mode. Table 1 summarizes the performance of the demo board at room temperature. The circuit can be easily modified for different applications.

Figure 6 shows the typical thermal performance of the circuit.

The demo board has an EMI filter installed on the bottom layer. The conducted and radiated EMI performance of the board is shown on Figure 4. The limit in Figure 4 is CISPR Class 5, Peak. It shows the circuit passes the CISPR Class 5, Peak test with a wide margin.

The LT8602 data sheet gives a complete description of the part, operation and application information. The data sheet must be read in conjunction with this quick start guide for DC1949A.

Design files for this circuit board are available at <http://www.linear.com/demo/DC1949A>

LT, LT, LTC, LTM, Linear Technology and the Linear Logo are registered trademarks of Linear Technology Corporation. All other trademarks are the property of their respective owners.

PERFORMANCE SUMMARY Specifications are at T_A = 25°C

Table 1

PARAMETER	CONDITIONS	MIN	TYP	MAX	UNITS
Input Voltage*		5.5	12	42	V
Standby Current When Switching	I _{OUT1,2,3,4} = 0mA, V _{IN} = 12V		60		μA
Output Voltage V _{OUT1}	V _{IN} = 12V, I _{OUT1} = 1A	4.80	5	5.20	V
Output Voltage V _{OUT2}	I _{OUT2} = 1A	3.17	3.3	3.43	V
Output Voltage V _{OUT3}	I _{OUT3} = 1A	1.73	1.8	1.87	V
Output Voltage V _{OUT4}	I _{OUT4} = 1A	1.15	1.2	1.25	V
Maximum Output Current I _{OUT1}	V _{IN} = 12V, No Load on Other Channels	1.5			A
Maximum Output Current I _{OUT2}	V _{IN} = 12V, No Load on Other Channels	2.5			A
Maximum Output Current I _{OUT3}	No Load on Other Channels	1.8			A
Maximum Output Current I _{OUT4}	No Load on Other Channels	1.8			A
Switching Frequency	V _{IN} = 12V, I _{OUT1,2,3,4} = 1.0A	1.85	2	2.15	MHz
Efficiency	V _{IN} = 12V, I _{OUT1,2,3,4} = 1.0A		80		%

Refer to Figure 6 to determine the maximum input voltage and load. If IC temperature exceeds target, reduce input voltage, output current or switching frequency.

dc1949af

QUICK START PROCEDURE

DC1949A is easy to set up to evaluate the performance of the LT8602. Refer to Figure 1 for proper equipment setup and follow the procedure below.

1. With power off, connect the input power supply to the board through V_{IN} and GND terminals on the top layer. Connect the loads to the terminals V_{OUT1} and GND, V_{OUT2} and GND, V_{OUT3} and GND, V_{OUT4} and GND on the board. The default positions of the Headers are given in Table 2.

Table 2. Default Positions of the Headers

NAME		POSITION
EN/UVLO	JP1	ON
TRKSS1	JP4	ON
TRKSS2	JP5	ON
RUN3	JP2	RUN
RUN4	JP3	RUN

2. Turn on the power at the input. Increase V_{IN} to 12V.

Note: Make sure that the input voltage is always within spec. Refer to data sheet on the burst mode operation in light load and high V_{IN} condition.

3. Check for the proper output voltages. The output should be regulated at 5.0V ($\pm 4\%$), 3.3V ($\pm 4\%$), 1.8V ($\pm 4\%$), 1.2V ($\pm 4\%$).

Note: Do not overload unless proper thermal cooling method such as air flow or heat sink is applied.

Note: If there is no output, temporarily disconnect the load to make sure that the load is not set too high, and the Headers of EN/UVLO, TRKSS1, TRKSS2, RUN3, RUN4, are set in right positions.

4. Once the proper output voltage is established, adjust the input voltage and load currents within the operating range and observe the output voltage regulation, transient, ripple voltage, efficiency and other parameters.

Note: Refer to the thermal derating curves in LT8602 data sheet for high input voltage and/or high ambient temperature operations.

Note: By default, SYNC is grounded, and the circuit is set in low ripple burst mode operation. Remove R16, and add R25 of 0Ω , the circuit is set in pulse-skipping mode. The circuit runs in full frequency with lower load current. Refer to the data sheet on the input voltage and load current ranges the circuit runs in full frequency. To synchronize to an external clock, apply the external clock to the SYNC turret.

Note: When measuring the input or output voltage ripples, care must be taken to avoid a long ground lead on the oscilloscope probe. Measure the input or output voltage ripple by touching the probe tip directly across the V_{IN} or V_{OUT} capacitor terminals. See Figure 2 for proper scope probe technique.

Note: The EMI filter is assembled on the bottom layer of the demo circuit. For EMI test, connect the EMI test facility to the terminals of $VEMI^+$, and $VEMI^-$ with very short wires.

QUICK START PROCEDURE

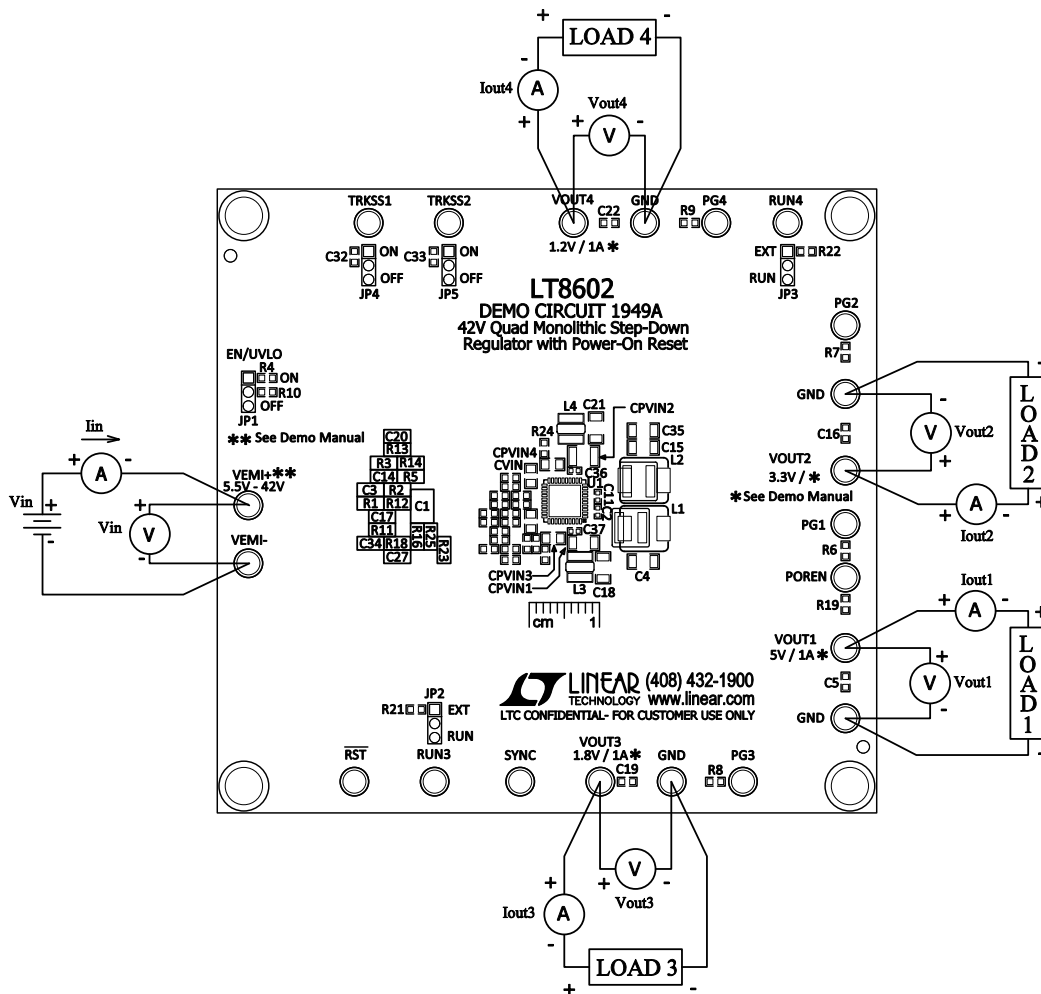

Figure 1. Proper Measurement Equipment Setup

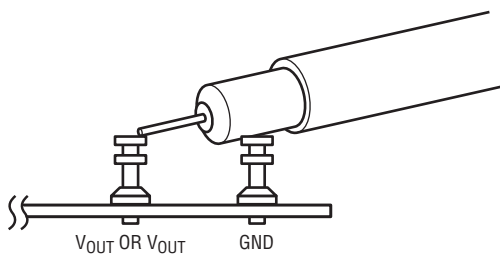
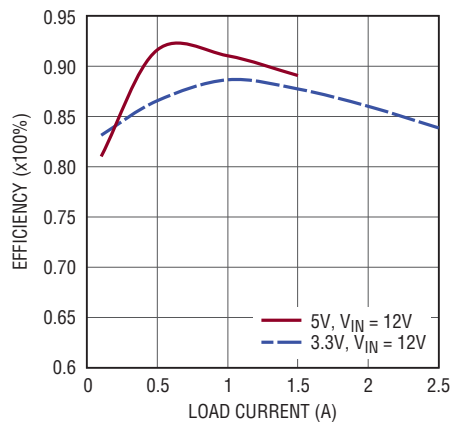

Figure 2. Proper Scope Probe Placement for Measuring Input or Output Ripple

QUICK START PROCEDURE



DC1939A F03

Figure 3. Typical Efficiency Curves of HV Bucks, at $V_{IN} = 12V$

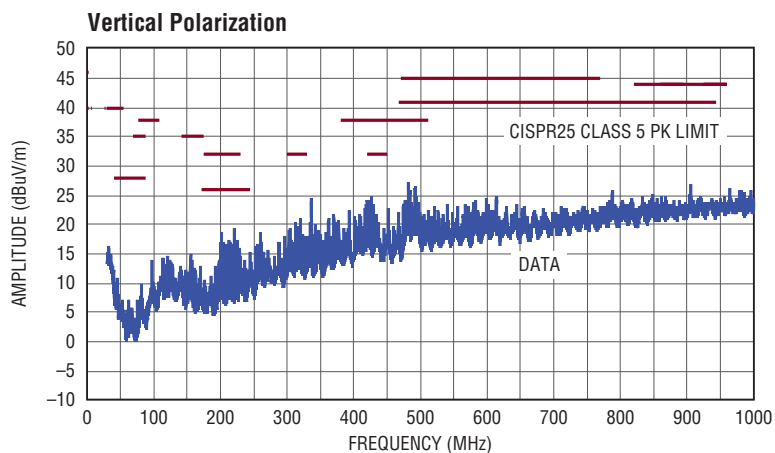

DC1939A F04a

(a)

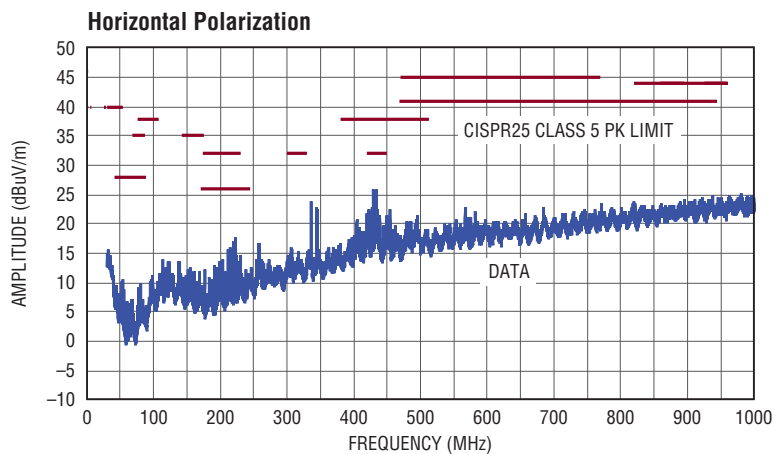

DC1939A F04b

(b)

Figure 4. Radiated EMI (Vertical/Horizontal), $V_{IN} = 12V$, $I_{OUT1,2,3,4} = 1A$

QUICK START PROCEDURE

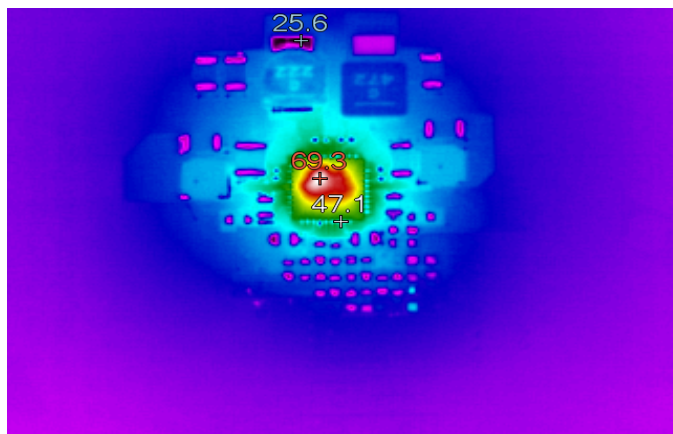

$V_{IN} = 12V$

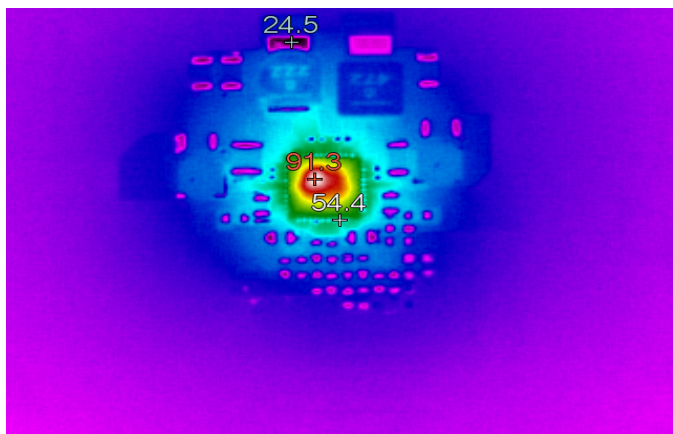

$V_{IN} = 24V$

Figure 5. Thermal Image Top View, $I_{OUT1,2,3,4} = 1A$, $T_A = 25^\circ C$, $f_{SW} = 2MHz$

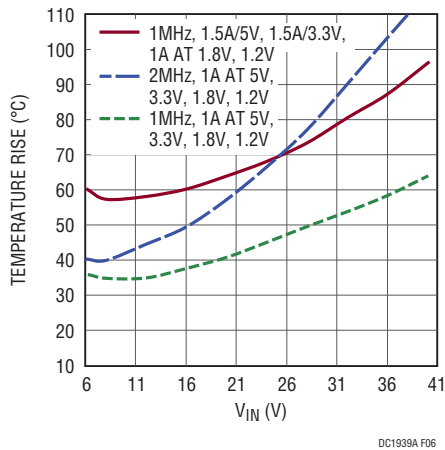

DC1939A F06

Figure 6. LT8602 Case Temperature Rise, $T_A = 25^\circ C$

DEMO MANUAL DC1949A

PARTS LIST

ITEM	QTY	REFERENCE	PART DESCRIPTION	MANUFACTURER/PART NUMBER
Required Circuit Components				
1	1	CPVIN1	Cap., X7R 4.7µF 50V 10% 1206	Murata GRM31CR71H475KA12L
2	1	CPVIN2	Cap., X7R 10µF 50V 10% 1210	Murata ERIE GRM32ER71H106KA12L
3	3	C1, CPVIN3, CPVIN4	Cap., X7R 4.7µF 10V 10% 0805	Murata GRM21BR71A475KA73L
4	1	CVIN	Cap., X7R 1µF 50V 10% 0805	TDK C2012X7R1H105KT
5	5	C2, C11, C36, C37, C39	Cap., X7R 0.1µF 50V 10% 0402	TDK CGA2B3X7R1H104K050BB
6	1	C3	Cap., NPO 4.7pF 25V 5% 0603	AVX 06033A4R7JAT2A
7	3	C14, C17, C20	Cap., NPO 27pF 25V 5% 0603	AVX 06033A270JAT2A
8	3	C4, C18, C21	Cap., X5R 47µF 10V 20% 1206	Murata GRM31CR61A476ME15L
9	4	C5, C16, C19, C22	Cap., X7R 0.1µF 50V 10% 0603	Murata GRM188R71H104KA93D
10	1	C6	Cap., Alum 22µF 50V 10%	Sun Elect. 50CE22BSS
11	1	C15	Cap., X5R 220µF 4V 20% 1206	Murata GRM31CR60G227ME11L
12	1	C27	Cap., X7R 220pF 25V 10% 0603	AVX 06033C221MAT2A
13	2	C29, C30	Cap., X5R 10µF 50V 10% 1206	Murata CGA5L3X5R1H106K160AB
14	2	C32, C33	Cap., X7R 47nF 25V 20% 0603	AVX 06033C473MAT2A
15	1	FB1	Ferrite Bead, 330Ω	TDK Corp. MPZ2012S331AT000
16	1	L1	Inductor, 4.7µH	Coilcraft XAL5030-472MEB
17	1	L2	Inductor, 2.2µH	Coilcraft XAL5030-222MEB
18	2	L3, L4	Inductor, 1.0µH ±30%	NIC Comp. Corp. NPIS42LS1R0YTRF
19	1	L5	Inductor, 0.22µH	Vishay, IHLP1212BZERR22M11
20	1	R1	Res., Chip 806k 0.06W 1% 0603	Vishay CRCW0603806KFKEA
21	2	R2, R5	Res., Chip 200k 0.06W 1% 0603	Vishay CRCW0603200KFKEA
22	1	R3	Res., Chip 464k 0.06W 1% 0603	Vishay CRCW0603464KFKEA
23	1	R4	Res., Chip 340k 0.06W 1% 0603	Vishay CRCW0603340KFKEA
24	4	R6, R7, R8, R9	Res., Chip 19.1k 0.06W 1% 0603	Vishay CRCW060319K1FKEA
25	4	R10, R19, R21, R22	Res., Chip 100k 0.06W 1% 0603	Vishay CRCW0603100KFKEA
26	1	R11	Res., Chip 187k 0.06W 1% 0603	Vishay CRCW0603187KFKEA
27	2	R12, R14	Res., Chip 150k 0.06W 1% 0603	Vishay CRCW0603150KFKEA
28	1	R13	Res., Chip 75.0k 0.06W 1% 0603	Vishay CRCW060375K0FKEA
29	1	R16	Res., Chip 10.0k 0.06W 1% 0603	Vishay CRCW060310K0FKEA
30	1	R18	Res., Chip 28.7k 0.06W 1% 0603	Vishay CRCW060328K7FKEA
31	2	R23, R24	Res, Chip 0Ω 0.25W 5A 0603	Vishay CRCW06030000Z0EA
32	1	U1	Buck Regulator QFN(40)(UJ) 6mm × 6mm	Linear Tech. Corp. LT8602EUJ#PBF
Additional Demo Board Circuit Components				
1	0	R25 (Opt)	Res, Chip 0Ω 0.25W 5A 0603	Vishay CRCW06030000Z0EA
2	0	C31, C34 (Opt)	Cap., 0603	
3	0	C35 (Opt)	Cap., 1206	
Hardware: For Demo Board Only				
1	5	XJP1, XJP2, XJP3, XJP4, XJP5	Shunt, 2mm Ctrs.	Samtec 2SN-BK-G
2	4	MH1-MH4	Stand-Off, Nylon 0.25" Tall	Keystone, 8831 (Snap On)
3	21	E1, E2, E3, E4, E5, E6, E7, E8, E9, E10, E11, E12, E13, E14, E15, E16, E17, E18, E19, E20, E21	Turret, Testpoint	Mill Max 2501-2-00-80-00-00-07-0
4	5	JP1, JP2, JP3, JP4, JP5	Headers, 3 Pins 2mm Ctrs.	Samtec TMM-103-02-L-S

dc1949af

SCHEMATIC DIAGRAM

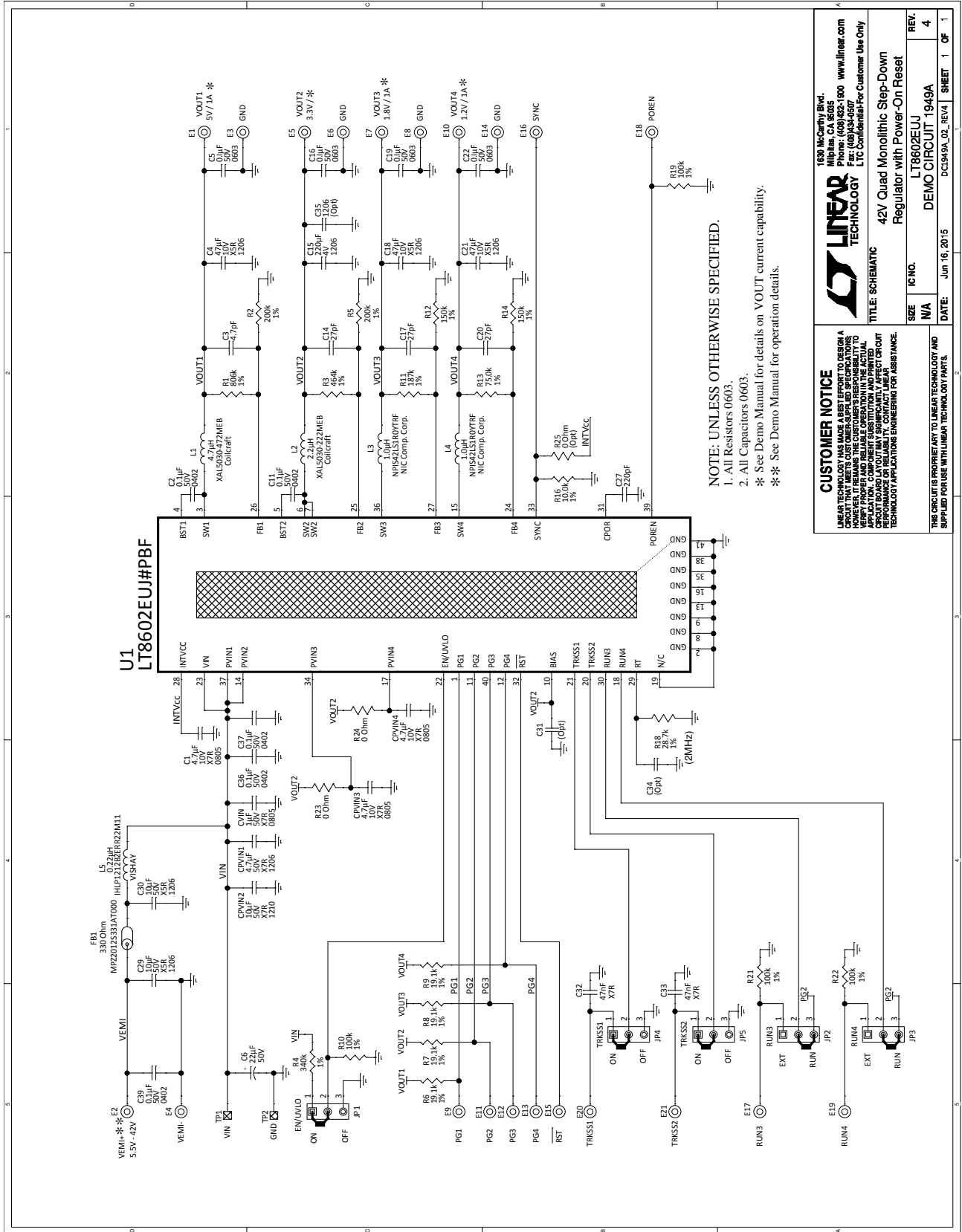

NOTE: UNLESS OTHERWISE SPECIFIED.
 1. All Resistors 0603.
 2. All Capacitors 0603.
 * See Demo Manual for details on VOUT current capability.
 ** See Demo Manual for operation details.

CUSTOMER NOTICE
 LINEAR TECHNOLOGY CORPORATION IS NOT RESPONSIBLE FOR ANY DAMAGE TO PROPERTY OR PERSONS THAT MAY BE CAUSED BY THE USE OF THIS PRODUCT. THE CUSTOMER ASSUMES ALL LIABILITY FOR THE PROPER USE OF THIS PRODUCT. THE CUSTOMER SHALL BE RESPONSIBLE FOR OBTAINING NECESSARY APPROVALS FROM ALL APPLICABLE REGULATORY AGENCIES. THE CUSTOMER SHALL BE RESPONSIBLE FOR OBTAINING NECESSARY APPROVALS FROM ALL APPLICABLE REGULATORY AGENCIES. THE CUSTOMER SHALL BE RESPONSIBLE FOR OBTAINING NECESSARY APPROVALS FROM ALL APPLICABLE REGULATORY AGENCIES.

1630 McCarty Blvd. Milpitas, CA 95035 Phone: (408) 955-1900 www.linear.com Fax: (408) 955-1901	
LINEAR TECHNOLOGY	
42V Quad Monolithic Step-Down Regulator with Power-On Reset	
TITLE: SCHEMATIC	REV. 4
SIZE: IC NO. LT8602EUJ	DEMO CIRCUIT 1949A
I/A	SHEET 1 OF 1
DATE: Jun 16, 2015	DC1949A_02_Rev14



Information furnished by Linear Technology Corporation is believed to be accurate and reliable. However, no responsibility is assumed for its use. Linear Technology Corporation makes no representation that the interconnection of its circuits as described herein will not infringe on existing patent rights.

DEMO MANUAL DC1949A

DEMONSTRATION BOARD IMPORTANT NOTICE

Linear Technology Corporation (LTC) provides the enclosed product(s) under the following **AS IS** conditions:

This demonstration board (DEMO BOARD) kit being sold or provided by Linear Technology is intended for use for **ENGINEERING DEVELOPMENT OR EVALUATION PURPOSES ONLY** and is not provided by LTC for commercial use. As such, the DEMO BOARD herein may not be complete in terms of required design-, marketing-, and/or manufacturing-related protective considerations, including but not limited to product safety measures typically found in finished commercial goods. As a prototype, this product does not fall within the scope of the European Union directive on electromagnetic compatibility and therefore may or may not meet the technical requirements of the directive, or other regulations.

If this evaluation kit does not meet the specifications recited in the DEMO BOARD manual the kit may be returned within 30 days from the date of delivery for a full refund. **THE FOREGOING WARRANTY IS THE EXCLUSIVE WARRANTY MADE BY THE SELLER TO BUYER AND IS IN LIEU OF ALL OTHER WARRANTIES, EXPRESSED, IMPLIED, OR STATUTORY, INCLUDING ANY WARRANTY OF MERCHANTABILITY OR FITNESS FOR ANY PARTICULAR PURPOSE. EXCEPT TO THE EXTENT OF THIS INDEMNITY, NEITHER PARTY SHALL BE LIABLE TO THE OTHER FOR ANY INDIRECT, SPECIAL, INCIDENTAL, OR CONSEQUENTIAL DAMAGES.**

The user assumes all responsibility and liability for proper and safe handling of the goods. Further, the user releases LTC from all claims arising from the handling or use of the goods. Due to the open construction of the product, it is the user's responsibility to take any and all appropriate precautions with regard to electrostatic discharge. Also be aware that the products herein may not be regulatory compliant or agency certified (FCC, UL, CE, etc.).

No License is granted under any patent right or other intellectual property whatsoever. **LTC assumes no liability for applications assistance, customer product design, software performance, or infringement of patents or any other intellectual property rights of any kind.**

LTC currently services a variety of customers for products around the world, and therefore this transaction **is not exclusive**.

Please read the DEMO BOARD manual prior to handling the product. Persons handling this product must have electronics training and observe good laboratory practice standards. **Common sense is encouraged.**

This notice contains important safety information about temperatures and voltages. For further safety concerns, please contact a LTC application engineer.

Mailing Address:

Linear Technology
1630 McCarthy Blvd.
Milpitas, CA 95035

Copyright © 2004, Linear Technology Corporation

Компания «Океан Электроники» предлагает заключение долгосрочных отношений при поставках импортных электронных компонентов на взаимовыгодных условиях!

Наши преимущества:

- Поставка оригинальных импортных электронных компонентов напрямую с производств Америки, Европы и Азии, а так же с крупнейших складов мира;
- Широкая линейка поставок активных и пассивных импортных электронных компонентов (более 30 млн. наименований);
- Поставка сложных, дефицитных, либо снятых с производства позиций;
- Оперативные сроки поставки под заказ (от 5 рабочих дней);
- Экспресс доставка в любую точку России;
- Помощь Конструкторского Отдела и консультации квалифицированных инженеров;
- Техническая поддержка проекта, помощь в подборе аналогов, поставка прототипов;
- Поставка электронных компонентов под контролем ВП;
- Система менеджмента качества сертифицирована по Международному стандарту ISO 9001;
- При необходимости вся продукция военного и аэрокосмического назначения проходит испытания и сертификацию в лаборатории (по согласованию с заказчиком);
- Поставка специализированных компонентов военного и аэрокосмического уровня качества (Xilinx, Altera, Analog Devices, Intersil, Interpoint, Microsemi, Actel, Aeroflex, Peregrine, VPT, Syfer, Eurofarad, Texas Instruments, MS Kennedy, Miteq, Cobham, E2V, MA-COM, Hittite, Mini-Circuits, General Dynamics и др.);

Компания «Океан Электроники» является официальным дистрибьютором и эксклюзивным представителем в России одного из крупнейших производителей разъемов военного и аэрокосмического назначения «**JONHON**», а так же официальным дистрибьютором и эксклюзивным представителем в России производителя высокотехнологичных и надежных решений для передачи СВЧ сигналов «**FORSTAR**».



JONHON

«**JONHON**» (основан в 1970 г.)

Разъемы специального, военного и аэрокосмического назначения:

(Применяются в военной, авиационной, аэрокосмической, морской, железнодорожной, горно- и нефтедобывающей отраслях промышленности)

«**FORSTAR**» (основан в 1998 г.)

ВЧ соединители, коаксиальные кабели,
кабельные сборки и микроволновые компоненты:

(Применяются в телекоммуникациях гражданского и специального назначения, в средствах связи, РЛС, а так же военной, авиационной и аэрокосмической отраслях промышленности).



Телефон: 8 (812) 309-75-97 (многоканальный)

Факс: 8 (812) 320-03-32

Электронная почта: ocean@oceanchips.ru

Web: <http://oceanchips.ru/>

Адрес: 198099, г. Санкт-Петербург, ул. Калинина, д. 2, корп. 4, лит. А