

FEATURES

- J-STD-020D reflow
- RoHS compliant
- Maxim MAX253 compatible
- 3.3V and 5V versions
- Isolation to 4kV_{DC}
- Frequency range to 500kHz
- Toroidal construction
- Industry-standard pinout
- UL 94 V-0 package materials
- Low profile
- Industrial temperature range

DESCRIPTION

The 78253 series of converter transformers are specifically designed for use with the MAX253 chip set to provide isolated power supplies. The 5V input version can supply 1W and the 3.3V input version can supply 500mW. A centre tapped secondary winding allows for full bridge, half bridge or voltage doubling.

For through hole versions see 78253 series datasheet.

SELECTION GUIDE

Order Code	Input Voltage	Output Voltage	Max. Output Current	Isolation Voltage	Turns Ratio
	V	V	mA	V _{DC}	
78253/35JC	3.3	5.0	100	1500	1:2.27
78253/55JC	5.0	5.0	200	1500	1:1.31
78253/35JVC	3.3	5.0	100	4000	1:2.14
78253/55JVC	5.0	5.0	200	4000	1:1.33

ORDER CODE DETAILS

Order Code	Package Type	Packaging Type	Quantity
78253/XXJC	6 Pin SM	Tube	50
78253/XXJC-R	6 Pin SM	Tape & Reel	500

78253/35JC CHARACTERISTICS

Parameter	Conditions	Min.	Typ.	Max.	Units
Primary Inductance, L _p	100kHz, 250mV	0.27	0.36	0.50	mH
Secondary Inductance, L _s	100kHz, 250mV	1.60	2.00	2.40	mH
Leakage Inductance, L _l	100kHz, 250mV		0.32	1.00	μH
Interwinding Capacitance, C _{ww}	100kHz, 250mV		24	50	pF
Primary D.C. Resistance, R _{DC}	>0.1VDC		0.5	1.00	Ω
Volt-time Product, Et	Pins 1/2 or 2/3	30	49		Vμs

78253/55JC CHARACTERISTICS

Parameter	Conditions	Min.	Typ.	Max.	Units
Primary Inductance, L _p	100kHz, 250mV	0.57	0.83	1.10	mH
Secondary Inductance, L _s	100kHz, 250mV	1.10	1.40	1.70	mH
Leakage Inductance, L _l	100kHz, 250mV		0.51	1.00	μH
Interwinding Capacitance, C _{ww}	100kHz, 250mV		30	50	pF
Primary D.C. Resistance, R _{DC}	>0.1VDC		0.70	1.50	Ω
Volt-time Product, Et	Pins 1/2 or 2/3	40	70		Vμs

78253/35JVC CHARACTERISTICS

Parameter	Conditions	Min.	Typ.	Max.	Units
Primary Inductance, L _p	100kHz, 20mV	110	142	203	μH
Secondary Inductance, L _s	100kHz, 20mV	550	710	850	μH
Leakage Inductance, L _l	100kHz, 250mV		3.46	5.00	μH
Interwinding Capacitance, C _{ww}	100kHz, 250mV		2	8.00	pF
Primary D.C. Resistance, R _{DC}	>0.1VDC		0.30	0.50	Ω
Volt-time Product, Et	Pins 1/2 or 2/3	18	30		Vμs

78253/55JVC CHARACTERISTICS

Parameter	Conditions	Min.	Typ.	Max.	Units
Primary Inductance, L _p	100kHz, 20mV	170	240	335	μH
Secondary Inductance, L _s	100kHz, 20mV	350	444	540	μH
Leakage Inductance, L _l	100kHz, 250mV		6.28	8.00	μH
Interwinding Capacitance, C _{ww}	100kHz, 250mV		3.4	8.00	pF
Primary D.C. Resistance, R _{DC}	>0.1VDC		0.40	0.60	Ω
Volt-time Product, Et	Pins 1/2 or 2/3	25	37		Vμs

All specifications typical at T_a=25°C



For full details go to
www.murata-ps.com/rohs

ABSOLUTE MAXIMUM RATINGS

Operating free air temperature range	-40°C to 85°C
Storage temperature range	-50°C to 125°C
Peak current I_{pk}	400mA
Isolation voltage 78253/XXJC (flash tested for 1 second)	1500Vdc
Isolation voltage 78253/XXJVC (flash tested for 1 second)	4000Vdc

PACKAGE SPECIFICATIONS

MECHANICAL DIMENSIONS

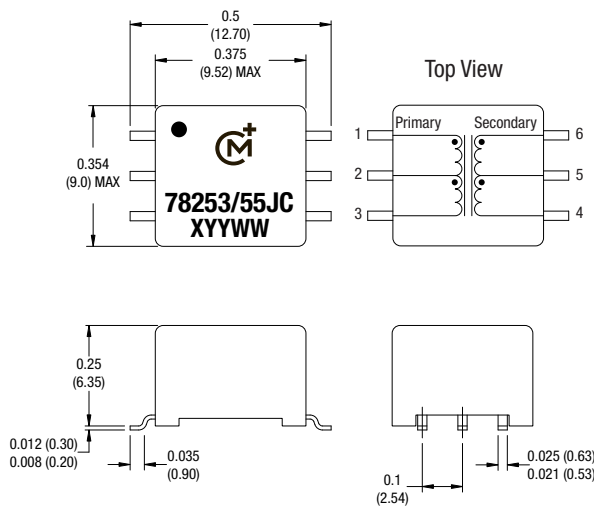

Unless otherwise stated all dimensions in inches (mm) ± 0.01 (0.25).
 All pins on a 0.1 (2.54) pitch and within ± 0.01 (0.25) of true position.
 Package weight 1.0g Typ.

RECOMMENDED FOOTPRINT DETAILS

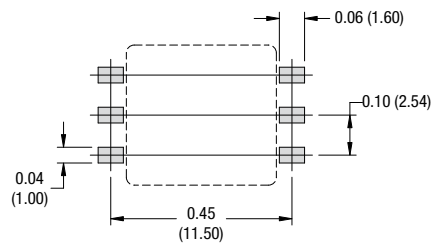

Unless otherwise stated all dimensions in inches (mm) ± 0.01 (0.25).
 All pins on a 0.1 (2.54) pitch and within ± 0.01 (0.25) of true position.

TYPICAL CHARACTERISTICS (VOLTAGE CURVES)

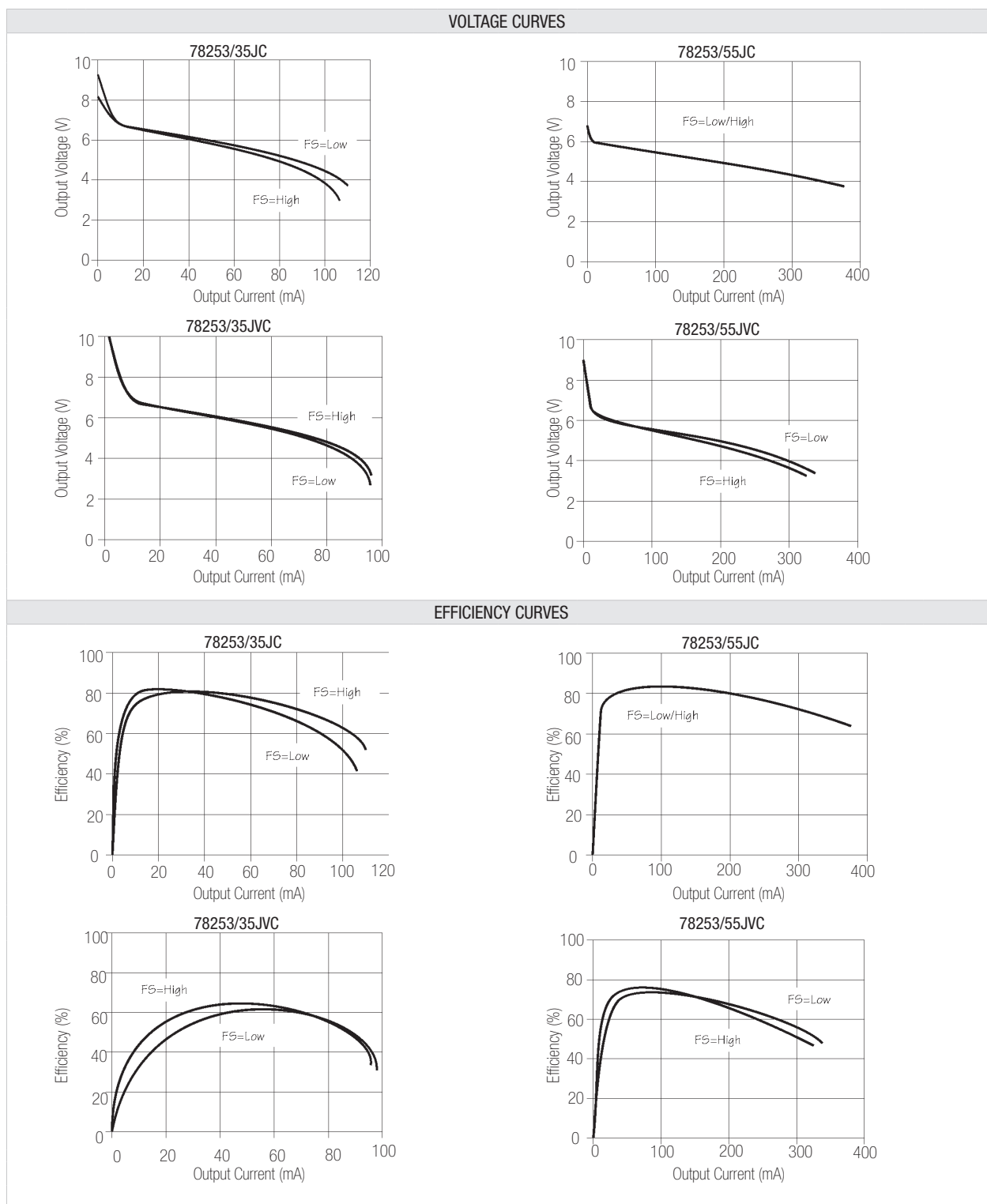

All curves are derived from testing with the Maxim MAX235 IC using the circuit shown in application note MPAN-03 (download at <http://www.murata-ps.com/data/apnotes/mpan-03.pdf>).

TYPICAL CHARACTERISTICS (VOLTAGE CURVES) continued

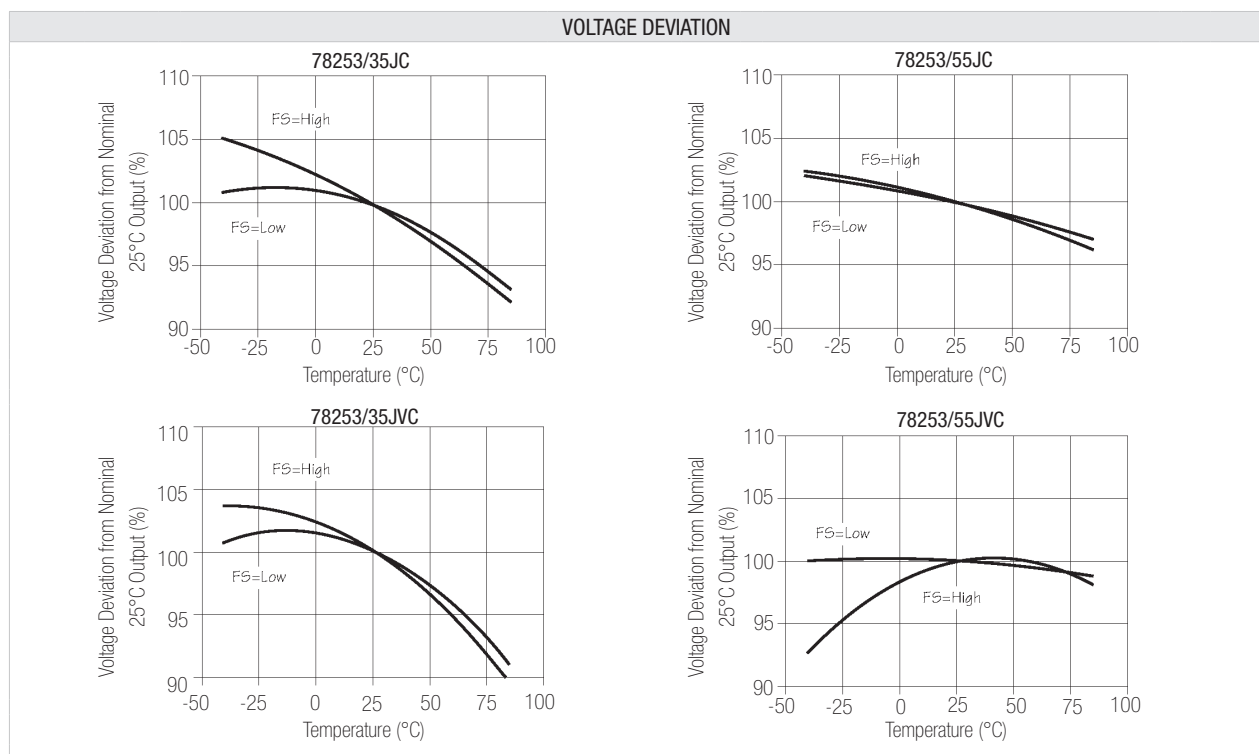

TECHNICAL NOTES

ISOLATION VOLTAGE

'Hi Pot Test', 'Flash Test', 'Withstand Voltage', 'Proof Voltage', 'Dielectric Withstand Voltage' & 'Isolation Test Voltage' are all terms that relate to the same thing, a test voltage, applied for a specified time, across a component designed to provide electrical isolation, to verify the integrity of that isolation.

All products in this series are 100% production tested at their stated isolation voltage.

A question commonly asked is, "What is the continuous voltage that can be applied across the part in normal operation?"

For a part holding no specific agency approvals both input and output should normally be maintained within SELV limits i.e. less than 42.4V peak, or 60VDC. The isolation test voltage represents a measure of immunity to transient voltages and the part should never be used as an element of a safety isolation system. The part could be expected to function correctly with several hundred volts offset applied continuously across the isolation barrier; but then the circuitry on both sides of the barrier must be regarded as operating at an unsafe voltage and further isolation/insulation systems must form a barrier between these circuits and any user-accessible circuitry according to safety standard requirements.

REPEATED HIGH-VOLTAGE ISOLATION TESTING

It is well known that repeated high-voltage isolation testing of a barrier component can actually degrade isolation capability, to a lesser or greater degree depending on materials, construction and environment. This series has toroidal isolation transformers, with no additional insulation between primary and secondary windings of enameled wire. While parts can be expected to withstand several times the stated test voltage, the isolation capability does depend on the wire insulation. Any material, including this enamel (typically polyurethane) is susceptible to eventual chemical degradation when subject to very high applied voltages thus implying that the number of tests should be strictly limited. We therefore strongly advise against repeated high voltage isolation testing, but if it is absolutely required, that the voltage be reduced by 20% from specified test voltage.

This consideration equally applies to agency recognized parts rated for better than functional isolation where the wire enamel insulation is always supplemented by a further insulation system of physical spacing or barriers.

SOLDERING INFORMATION¹

Pin finish	Matte tin
Max. peak reflow temperature	245°C
Moisture sensitivity level ²	1
Max. time above liquidous (217°C)	100s

TUBE OUTLINE DIMENSIONS

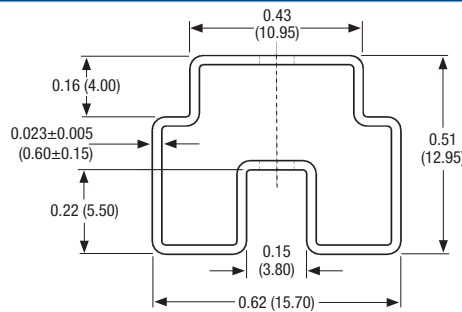

Tube length: 18.3±0.08 (465±2). Tube quantity: 50.
Tube material: Antistatic coated clear pvc.

Unless otherwise stated all dimensions in inches(mm) ±0.01 (0.25).

All specifications typical at $T_a=25^\circ\text{C}$

- For further information, please visit www.murata-ps.com/rohs
- Representative samples of the product were subjected to the conditioning described in IPC/JEDEC J-STD-020D and passed electrical testing, package coplanarity and visual inspection which revealed no external cracks or changes in package body flatness.

TAPE & REEL SPECIFICATIONS

REEL OUTLINE DIMENSIONS

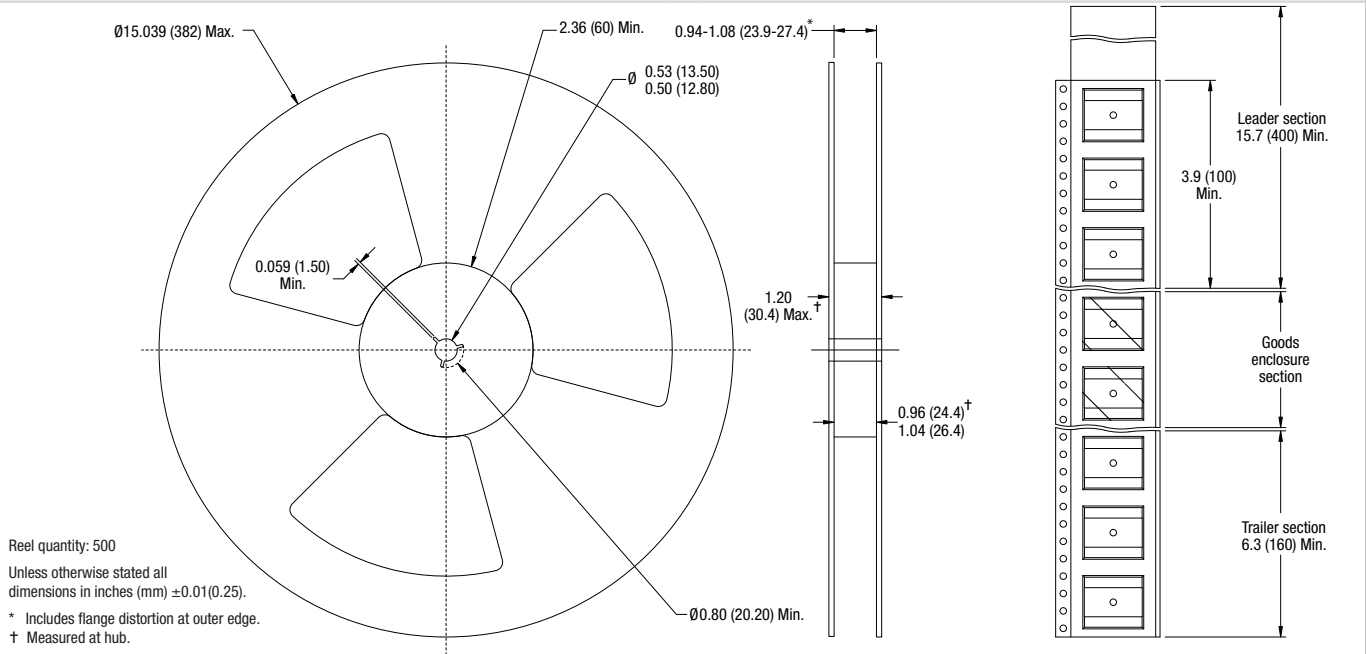

TAPE OUTLINE DIMENSIONS

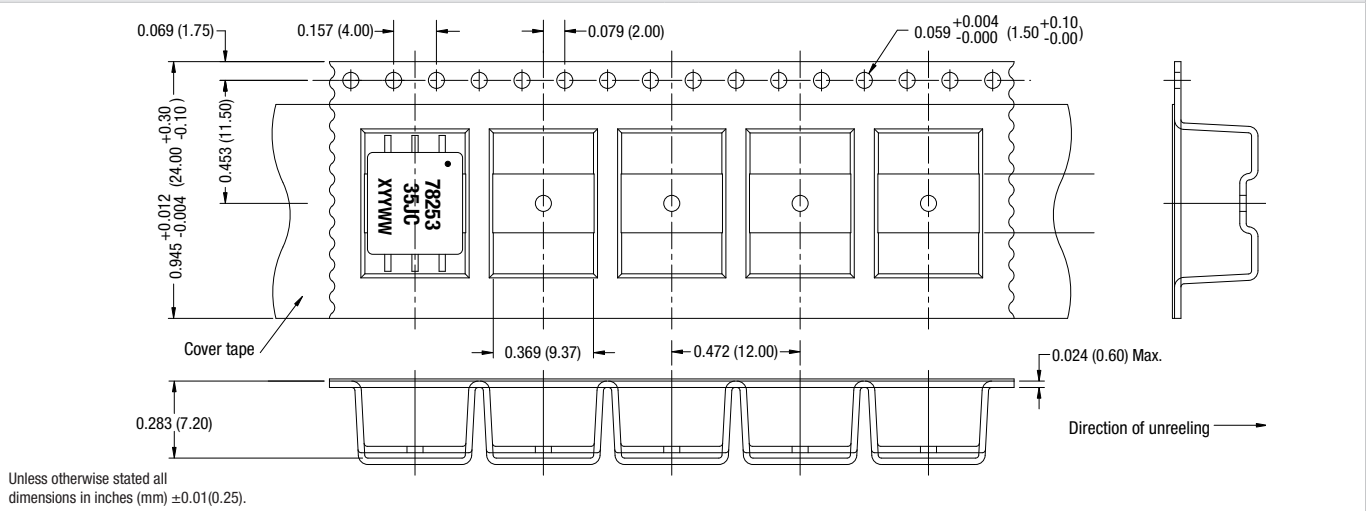

Murata Power Solutions, Inc.
 11 Cabot Boulevard, Mansfield, MA 02048-1151 U.S.A.
 ISO 9001 and 14001 REGISTERED

Murata Power Solutions, Inc. makes no representation that the use of its products in the circuits described herein, or the use of other technical information contained herein, will not infringe upon existing or future patent rights. The descriptions contained herein do not imply the granting of licenses to make, use, or sell equipment constructed in accordance therewith. Specifications are subject to change without notice.
 © 2010 Murata Power Solutions, Inc.

Компания «Океан Электроники» предлагает заключение долгосрочных отношений при поставках импортных электронных компонентов на взаимовыгодных условиях!

Наши преимущества:

- Поставка оригинальных импортных электронных компонентов напрямую с производств Америки, Европы и Азии, а так же с крупнейших складов мира;
- Широкая линейка поставок активных и пассивных импортных электронных компонентов (более 30 млн. наименований);
- Поставка сложных, дефицитных, либо снятых с производства позиций;
- Оперативные сроки поставки под заказ (от 5 рабочих дней);
- Экспресс доставка в любую точку России;
- Помощь Конструкторского Отдела и консультации квалифицированных инженеров;
- Техническая поддержка проекта, помощь в подборе аналогов, поставка прототипов;
- Поставка электронных компонентов под контролем ВП;
- Система менеджмента качества сертифицирована по Международному стандарту ISO 9001;
- При необходимости вся продукция военного и аэрокосмического назначения проходит испытания и сертификацию в лаборатории (по согласованию с заказчиком);
- Поставка специализированных компонентов военного и аэрокосмического уровня качества (Xilinx, Altera, Analog Devices, Intersil, Interpoint, Microsemi, Actel, Aeroflex, Peregrine, VPT, Syfer, Eurofarad, Texas Instruments, MS Kennedy, Miteq, Cobham, E2V, MA-COM, Hittite, Mini-Circuits, General Dynamics и др.);

Компания «Океан Электроники» является официальным дистрибьютором и эксклюзивным представителем в России одного из крупнейших производителей разъемов военного и аэрокосмического назначения «JONHON», а так же официальным дистрибьютором и эксклюзивным представителем в России производителя высокотехнологичных и надежных решений для передачи СВЧ сигналов «FORSTAR».



JONHON

«JONHON» (основан в 1970 г.)

Разъемы специального, военного и аэрокосмического назначения:

(Применяются в военной, авиационной, аэрокосмической, морской, железнодорожной, горно- и нефтедобывающей отраслях промышленности)

«FORSTAR» (основан в 1998 г.)

ВЧ соединители, коаксиальные кабели, кабельные сборки и микроволновые компоненты:

(Применяются в телекоммуникациях гражданского и специального назначения, в средствах связи, РЛС, а так же военной, авиационной и аэрокосмической отраслях промышленности).



Телефон: 8 (812) 309-75-97 (многоканальный)

Факс: 8 (812) 320-03-32

Электронная почта: ocean@oceanchips.ru

Web: <http://oceanchips.ru/>

Адрес: 198099, г. Санкт-Петербург, ул. Калинина, д. 2, корп. 4, лит. А