150mA Voltage Regulator (Wide Input Voltage Range)

NO.EA-100-061107

OUTLINE

The R1154x series are CMOS-based voltage regulator (VR) ICs. The R1154xxxxxx has features of high output voltage accuracy and ultra-low supply current. A peak current limit circuit, a short current limit circuit, and a thermal shutdown circuit are built in the R1154x series.

The regulator output voltage is fixed in the R1154xxxxB, while adjustable type is the R1154x001C.

Output voltage accuracy is $\pm 2.0\%$.

Since the packages for these ICs are the SOT-89-5 and SOT-23-5, high density mounting of the ICs on boards is possible.

FEATURES

- Supply Current Typ. 5.0 μ A
- Standby Current Typ. 0.1 μ A
- Output Voltage Accuracy $\pm 2.0\%$
- Wide Output Voltage Range 2.5V to 12.0V(xxxxB)
adjustable in the range of 2.5V to V_{IN} or 24.0V (001C)
- Input Voltage Max. 24.0V
- Output Current Min. 140mA ($V_{IN}=V_{OUT}+2.0V$, 2.5V Output type)
Min. 150mA ($V_{IN}=V_{OUT}+2.0V$, 3.0V Output type)
- Package SOT-89-5, SOT-23-5
- Built-in Peak Current Limit Circuit
- Short Current Limit Circuit
- Thermal Shutdown Circuit

APPLICATIONS

- Power source for home appliances such as refrigerators, rice cookers, Electronic water warmers, etc.
- Power source for car audio equipment, car navigation system, and ETC system.
- Power source for notebook PCs, digital TVs, cordless phones, and LAN system.
- Power source for copiers, printers, facsimiles, and scanners.

BLOCK DIAGRAMS



SELECTION GUIDE

The output voltage can be selected at the user's request.
 The selection can be made with designating the part number as follows;

R1154xxxx-xx-x ←Part Number
 ↑ ↑ ↑ ↑ ↑
 a b c d e

Code	Contents
a	Designation of package type; H: SOT-89-5 N: SOT-23-5
b	Designation of output voltage: Adjustable: 001 (Reference voltage=2.5V) Fixed: Stepwise Setting in the range from 2.5V to 12.0V
c	Designation of Output Type; B: Fixed Output Type C: Adjustable Output Type
d	Designation of Taping Type; T1, T2 (SOT-89-5), TR (SOT-23-5) (Refer to Taping Specifications)
e	Designation of composition of plating: -F: Lead free plating (SOT-23-5,SOT-89-5)

PIN CONFIGURATION



PIN DESCRIPTION

• SOT-89-5

Pin No	Symbol	Description
1	V_{OUT}	Voltage Regulator Output Pin
2	GND	Ground Pin
3	CE	Chip Enable Pin
4	NC/ADJ	B version: No Connection C version: Reference Voltage of Adjustable Output Pin
5	V_{DD}	Input Pin

• SOT-23-5

Pin No	Symbol	Description
1	V_{OUT}	Voltage Regulator Output Pin
2	GND	Ground Pin
3	V_{DD}	Input Pin
4	NC/ADJ	B version: No Connection C version: Reference Voltage of Adjustable Output Pin
5	CE	Chip Enable Pin

ABSOLUTE MAXIMUM RATINGS

Symbol	Item	Rating	Unit
V_{IN}	Input Voltage	26.0	V
V_{CE}	Input Voltage (CE Input Pin)	-0.3 to $V_{IN}+0.3$	V
V_{OUT}	Output Voltage	-0.3 to $V_{IN}+0.3$	V
V_{ADJ}	Output Voltage (ADJ Pin)	-0.3 to $V_{IN}+0.3$	V
I_{OUT}	Output Current	250	mA
P_D	Power Dissipation (SOT-23-5) ^{*Note1}	420	mV
	Power Dissipation (SOT-89-5) ^{*Note1}	900	
T_{opt}	Operating Temperature	-40 to +105	°C
T_{stg}	Storage Temperature	-55 to +125	°C

*Note1) For Power Dissipation please refer to PACKAGE INFORMATION to be described.

ELECTRICAL CHARACTERISTICS

• R1154xxxxB

$T_{opt}=25^{\circ}\text{C}$

Symbol	Item	Conditions	Min.	Typ.	Max.	Unit
V_{IN}	Input Voltage				24	V
V_{OUT}	Output Voltage	$V_{IN}=V_{OUT}+2.0\text{V}$	$\times 0.98$		$\times 1.02$	V
I_{OUT}	Output Current	$V_{IN}-V_{OUT}=2.0\text{V}$	Refer to the Output Current Table			
I_{SS}	Supply Current	$V_{IN}=V_{CE}$ $V_{IN}-V_{OUT}=2.0\text{V}$		5	10	μA
$I_{standby}$	Standby Current	$V_{IN}=24\text{V}$, $V_{CE}=0\text{V}$		0.1	1.0	μA
$\frac{\Delta V_{OUT}}{\Delta I_{OUT}}$	Load regulation	$V_{IN}-V_{OUT}=2.0\text{V}$ $1\text{mA} \leq I_{OUT} \leq 40\text{mA}$	Refer to the Load Regulation Table			
$\frac{\Delta V_{OUT}}{\Delta V_{IN}}$	Line regulation	$I_{OUT}=20\text{mA}$ $V_{OUT}+1\text{V} \leq V_{IN} \leq 24\text{V}$		0.05	0.20	%/V
V_{DIF}	Dropout Voltage	$I_{OUT}=20\text{mA}$	Refer to the Dropout Voltage Table			
$\frac{\Delta V_{OUT}}{\Delta T_{opt}}$	Output Voltage Temperature Coefficient	$V_{IN}-V_{OUT}=2.0\text{V}$ $I_{OUT}=20\text{mA}$ $-40^{\circ}\text{C} \leq T_{opt} \leq 105^{\circ}\text{C}$		± 100		ppm/°C
I_{lim}	Short Current Limit	$V_{OUT}=0\text{V}$		45		mA
V_{CEH}	CE "H" Input Voltage		2.1		V_{IN}	V
V_{CEL}	CE "L" Input Voltage		0.0		0.3	V
T_{SD}	Thermal Shutdown Temperature	Junction Temperature		150		°C
T_{SR}	Thermal Shutdown Released Temperature	Junction Temperature		125		°C

• R1154xxxxC

T_{opt}=25°C

Symbol	Item	Conditions	Min.	Typ.	Max.	Unit
V _{IN}	Input Voltage				24	V
V _{OUT}	Output Voltage	V _{IN} =V _{OUT} +2.0V, V _{OUT} =V _{ADJ} I _{OUT} =20mA	2.45	2.50	2.55	V
I _{OUT}	Output Current	V _{IN} =V _{OUT} +2.0V, V _{OUT} =V _{ADJ}	140			mA
I _{SS}	Supply Current	V _{IN} =V _{OUT} +2.0V, V _{OUT} =V _{ADJ} V _{CE} =V _{IN}		5	10	μA
I _{standby}	Standby Current	V _{IN} =24V, V _{OUT} =V _{ADJ} V _{CE} =0V		0.1	1.0	μA
ΔV _{OUT} /ΔI _{OUT}	Load regulation	V _{IN} =V _{OUT} +2.0V, V _{OUT} =V _{ADJ} 1mA ≤ I _{OUT} ≤ 40mA		20	50	mV
ΔV _{OUT} /ΔV _{IN}	Line regulation	V _{OUT} +1V ≤ V _{IN} ≤ 24V V _{OUT} =V _{ADJ} , I _{OUT} =20mA		0.05	0.20	%/V
V _{DIF}	Dropout Voltage	V _{OUT} =V _{ADJ} , I _{OUT} =20mA		0.20	0.40	V
ΔV _{OUT} /ΔT _{opt}	Output Voltage Temperature Coefficient	V _{IN} =V _{OUT} +2.0V, V _{OUT} =V _{ADJ} I _{OUT} =20mA -40°C ≤ T _{opt} ≤ 105°C		±100		ppm/°C
I _{lim}	Short Current Limit	V _{OUT} =V _{ADJ} =0V		45		mA
V _{CEH}	CE "H" Input Voltage		2.1		V _{IN}	V
V _{CEL}	CE "L" Input Voltage		0.0		0.3	V
T _{SD}	Thermal Shutdown Temperature	Junction Temperature		150		°C
T _{SR}	Thermal Shutdown Released Temperature	Junction Temperature		125		°C

• Output Current (T_{opt}=25°C)

Output Voltage V _{OUT} (V)	Output Current (mA)
	Min.
2.5 ≤ V _{OUT} ≤ 2.9	140
3.0 ≤ V _{OUT} ≤ 12.0	150

• Load Regulation (T_{opt}=25°C)

Output Voltage V _{OUT} (V)	Load Regulation (mV)	
	Typ.	Max.
2.5 ≤ V _{OUT} ≤ 3.0	20	50
3.1 ≤ V _{OUT} ≤ 5.0	30	75
5.1 ≤ V _{OUT} ≤ 12.0	40	115

• Dropout Voltage (T_{opt}=25°C)

Output Voltage V _{OUT} (V)	Dropout Voltage (V)	
	Typ.	Max.
2.5 ≤ V _{OUT} ≤ 7.0	0.20	0.40
7.1 ≤ V _{OUT} ≤ 10.0	0.25	0.50
10.1 ≤ V _{OUT} ≤ 12.0	0.30	0.55

TYPICAL APPLICATIONS

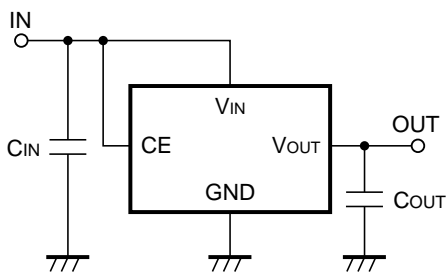

Fixed Output Voltage Type

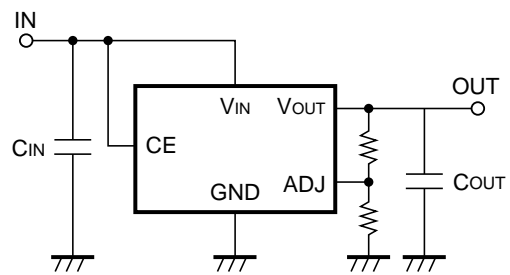

Adjustable Type

TEST CIRCUITS

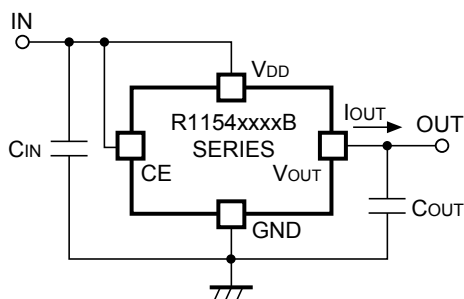

R1154xxxxB Standard Test Circuit

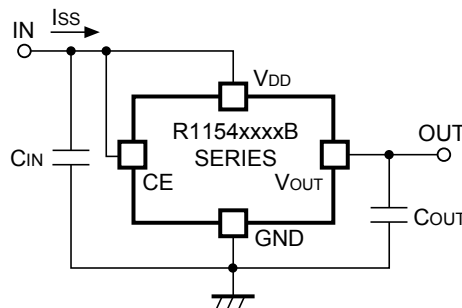

R1154xxxxB Supply Current Test Circuit

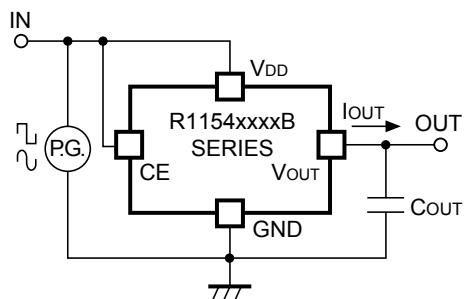

R1154xxxxB Input Transient Response Test Circuit

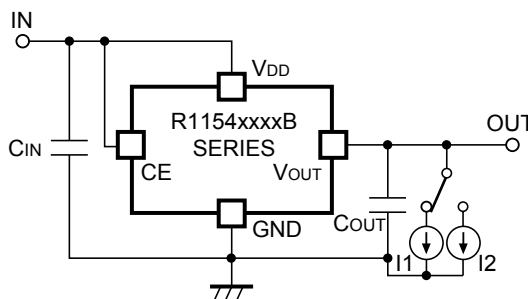

R1154xxxxB Load Regulation Test Circuit

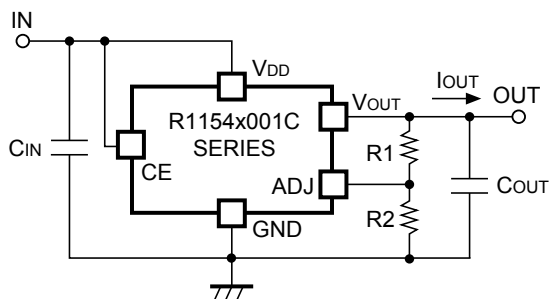

R1154x001C Standard Test Circuit

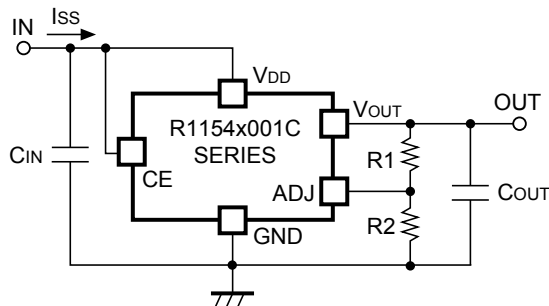

R1154x001C Supply Current Test Circuit

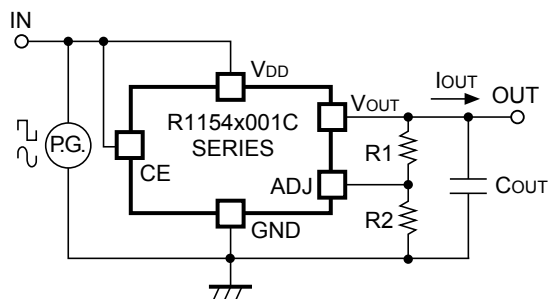

R1154x001C Input Transient Response Test Circuit

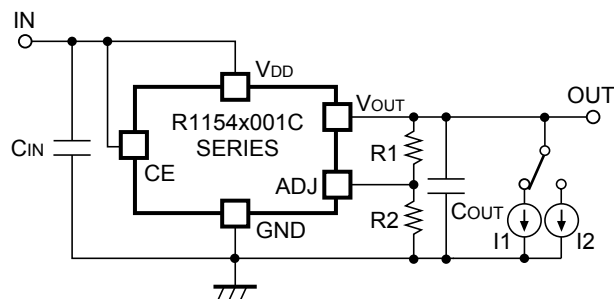

R1154x001C Load Transient Response Test Circuit

TYPICAL CHARACTERISTICS

1) Output Voltage vs. Output Current

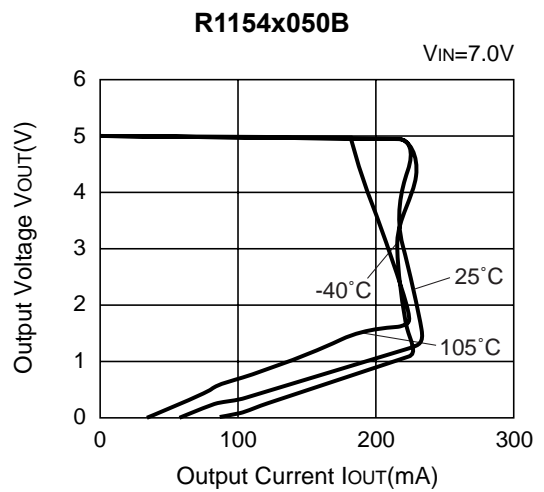
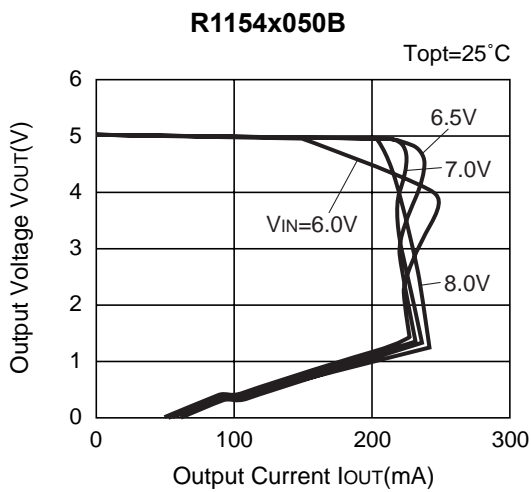
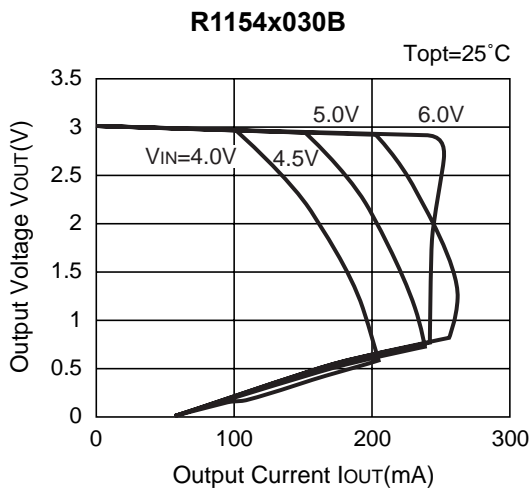
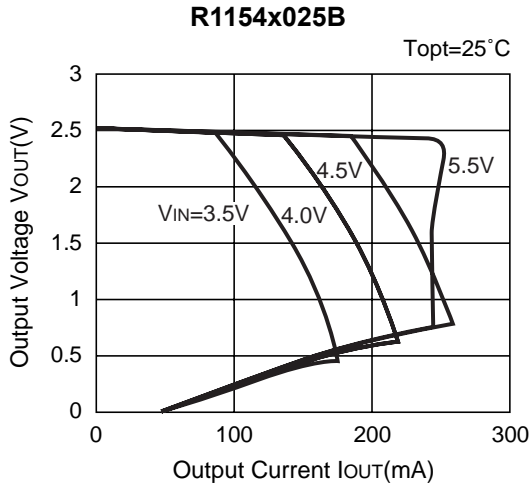

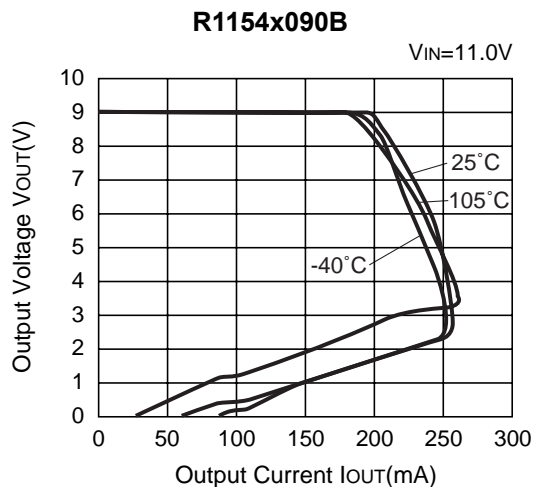

2) Input Voltage vs. Output Voltage ($T_{opt}=25^{\circ}\text{C}$)

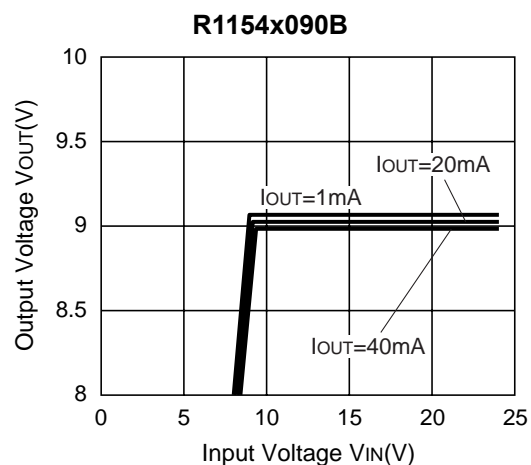
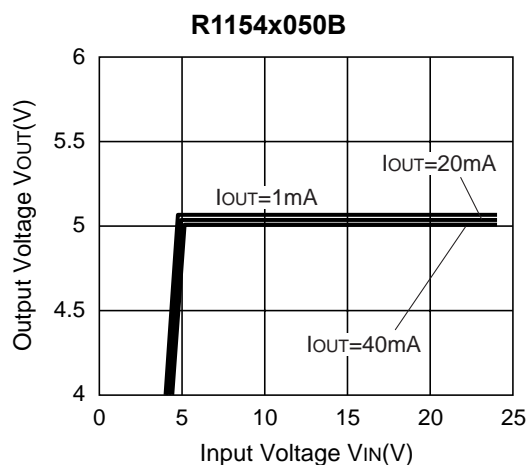
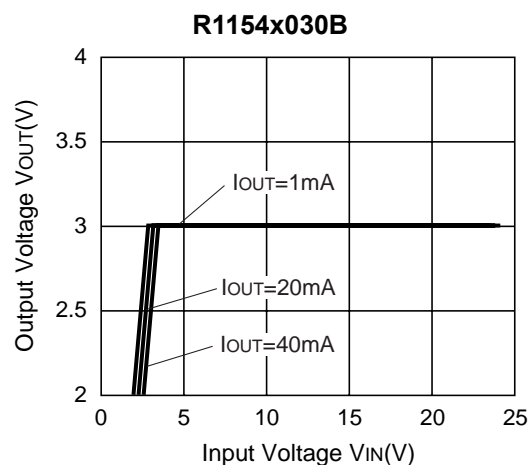
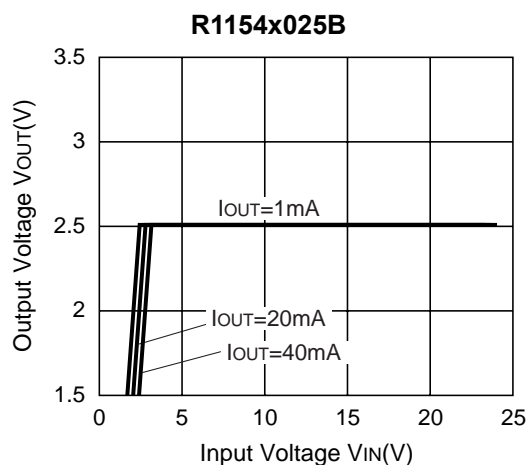

3) Dropout Voltage vs. Output Current



4) Output Voltage vs. Temperature





5) Supply Current vs. Input Voltage (T_{opt}=25°C)



6) Supply Current vs. Temperature

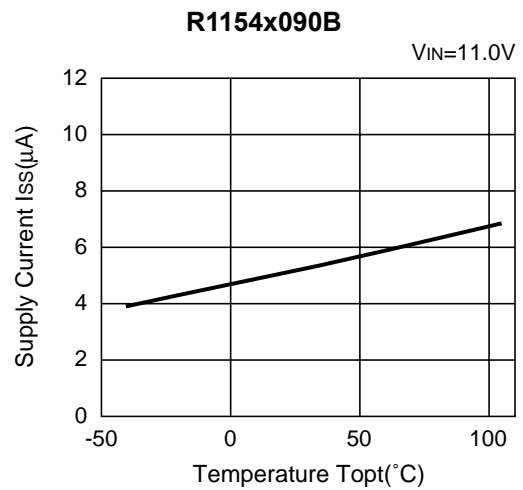
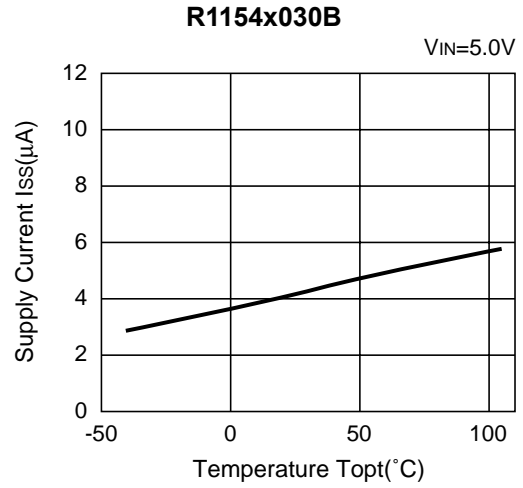

7) Input Transient Response ($I_{OUT}=20mA$, $C_{OUT}=0.1\mu F$, $T_{opt}=25^\circ C$)





8) Load Transient Response ($C_{OUT}=0.1\mu F$, $T_{opt}=25^{\circ}C$)

R1154x025B



R1154x030B



R1154x050B





9) Thermal Shutdown Characteristics

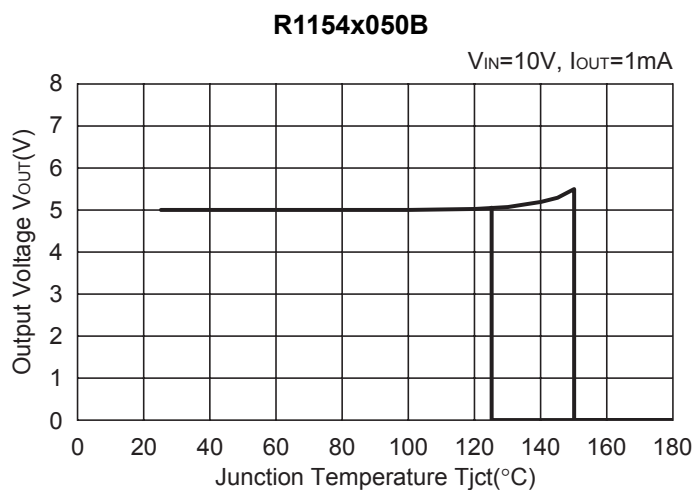

TECHNICAL NOTES

Phase Compensation

Phase Compensation of the R1154x Series has been made internally for stable operation even though the load current would vary. Therefore, without the capacitors, C_{IN} and C_{OUT} , the output voltage is regulated, however, for more stable operation, use capacitors as C_{IN} and C_{OUT} . Especially, if the input line is long and impedance is high, C_{IN} is necessary, moreover, if you use C_{OUT} , transient response will be improved. Recommended value is in the range from $0.1\mu\text{F}$ to $2.2\mu\text{F}$. Wiring should be made as short as possible.

Connect the capacitor, C_{IN} between V_{DD} pin and GND pin and C_{OUT} between V_{OUT} and GND as close as possible.

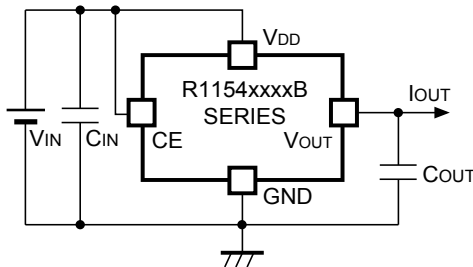

R1154xxxxB Typical Application

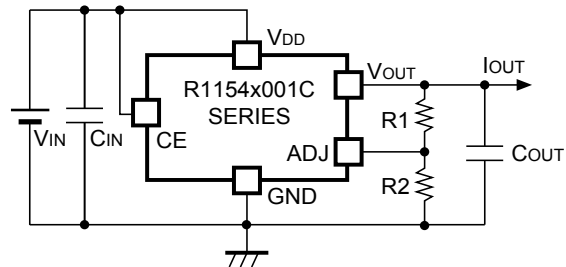

R1154xxxxC Typical Application

Thermal Shutdown

Thermal shutdown function is included in the R1154x Series, if the junction temperature is equal or more than $+150^{\circ}\text{C}$ (Typ.), the operation of regulator would stop. After that, when the junction temperature is equal or less than $+125^{\circ}\text{C}$ (Typ.), the operation of regulator would restart. Unless the cause of rising temperature would remove, the regulator repeats on and off, and output waveform would be like consecutive pulses.

Chip Enable Circuit

Do not make voltage level of chip enable pin keep floating level, or in between V_{IH} and V_{IL} . Unless otherwise, Output voltage would be unstable or indefinite, or unexpected current would flow internally.

* Technical Notes on Output Voltage Setting of C type

Figure 1. Adjustable Regulator (C type)

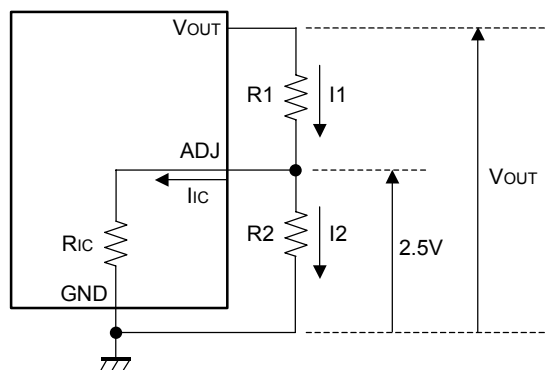

The Output Voltage of Regulator in R1154xxxxC may be adjustable for any output voltage between its 2.5V reference and its V_{DD} setting level. An external pair of resistors is required, as shown in Figure 1. The complete equation for the output voltage is described step by step as follows;

$$I_1 = I_{IC} + I_2 \dots\dots\dots (1)$$

$$I_2 = 2.5/R_2 \dots\dots\dots (2)$$

Thus,

$$I_1 = I_{IC} + 2.5/R_2 \dots\dots\dots (3)$$

Therefore,

$$V_{OUT} = 2.5 + R_1 \times I_1 \dots\dots\dots (4)$$

Put Equation (3) into Equation (4), then

$$\begin{aligned} V_{OUT} &= 2.5 + R_1(I_{IC} + 2.5/R_2) \\ &= 2.5(1 + R_1/R_2) + R_1 \times I_{IC} \dots\dots\dots (5) \end{aligned}$$

In 2nd term, or $R_1 \times I_{IC}$ will produce an error in V_{OUT} .

In Equation (5),

$$I_{IC} = 2.5/R_{IC} \dots\dots\dots (6)$$

$$\begin{aligned} R_1 \times I_{IC} &= R_1 \times 2.5/R_{IC} \\ &= 2.5 \times R_1/R_{IC} \dots\dots\dots (7) \end{aligned}$$

For better accuracy, choosing $R_1 \ll R_{IC}$ reduces this error.

Adjustable Resister Dependence of Output Voltage (Topt=25°C)

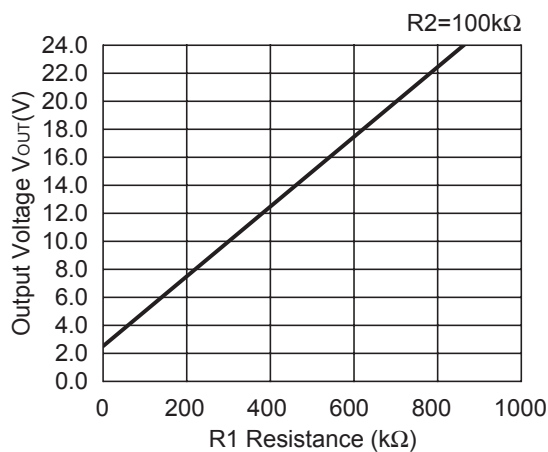
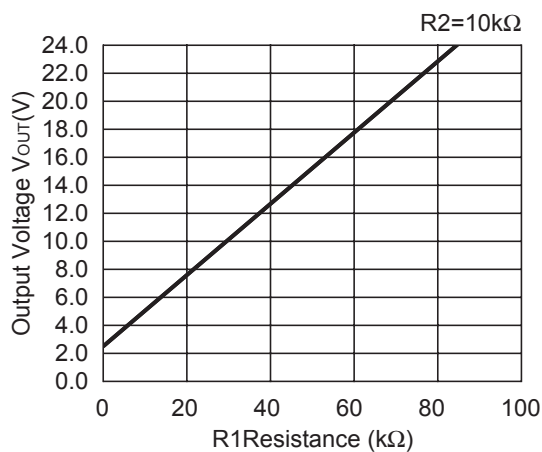

POWER DISSIPATION (SOT-23-5)

This specification is at mounted on board. Power Dissipation (P_D) depends on conditions of mounting on board.

This specification is based on the measurement at the condition below:

(Power Dissipation (SOT-23-5) is substitution of SOT-23-6.)

Measurement Conditions

	Standard Land Pattern
Environment	Mounting on Board (Wind velocity=0m/s)
Board Material	Glass cloth epoxy plactic (Double sided)
Board Dimensions	40mm × 40mm × 1.6mm
Copper Ratio	Top side : Approx. 50% , Back side : Approx. 50%
Through-hole	φ0.5mm × 44pcs

Measurement Result

($T_{opt}=25^{\circ}C, T_{jmax}=125^{\circ}C$)

	Standard Land Pattern	Free Air
Power Dissipation	420mW	250mW
Thermal Resistance	$\theta_{ja}=(125-25^{\circ}C)/0.42W=263^{\circ}C/W$	400 $^{\circ}C/W$



Power Dissipation

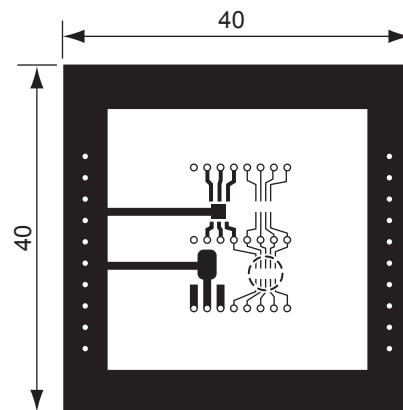

Measurement Board Pattern

○ IC Mount Area Unit : mm

RECOMMENDED LAND PATTERN

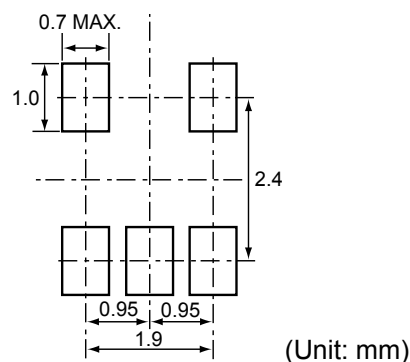

• SOT-89-5

Unit: mm

PACKAGE DIMENSIONS

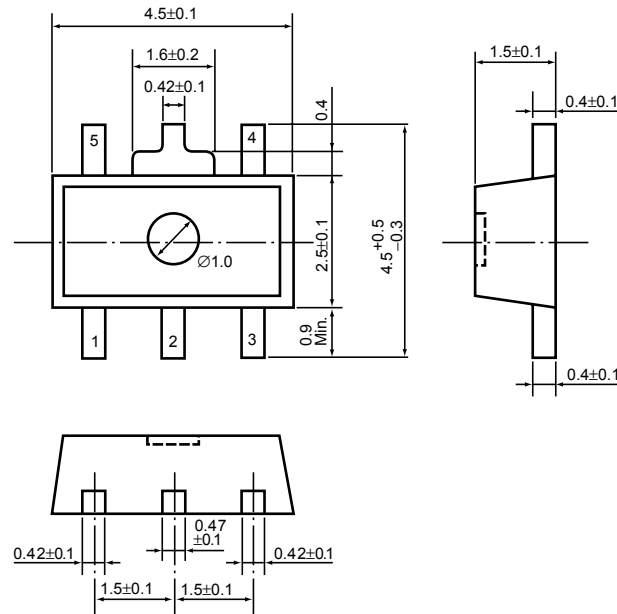

TAPING SPECIFICATION (T1: Standard Type)

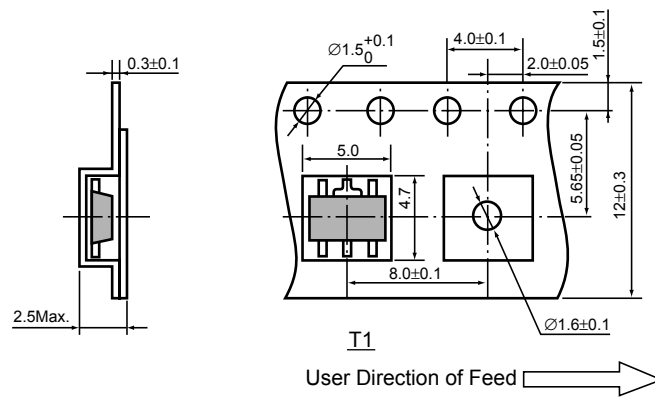

TAPING REEL DIMENSIONS REUSE REEL (EIAJ-RRM-12Bc)

(1reel=1000pcs)

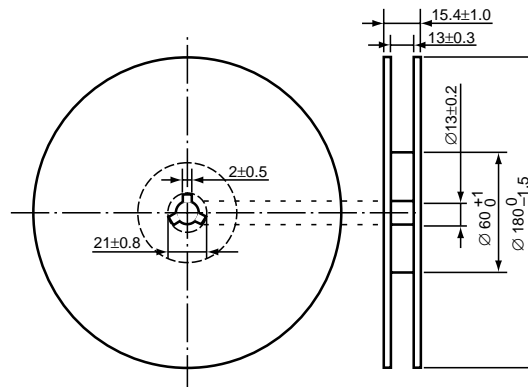

POWER DISSIPATION (SOT-89-5)

This specification is at mounted on board. Power Dissipation (P_D) depends on conditions of mounting on board. This specification is based on the measurement at the condition below:

Measurement Conditions

	High Wattage Land Pattern	Standard Land Pattern
Environment	Mounting on Board (Wind velocity=0m/s)	Mounting on Board (Wind velocity=0m/s)
Board Material	Glass cloth epoxy plastic (Double sided)	Glass cloth epoxy plastic (Double sided)
Board Dimensions	30mm × 30mm × 1.6mm	50mm × 50mm × 1.6mm
Copper Ratio	Top side : Approx. 20% , Back side : Approx. 100%	Top side : Approx. 10% , Back side : Approx. 100%
Through-hole	φ0.85mm × 10pcs	-

Measurement Result

($T_{opt}=25^{\circ}C, T_{jmax}=125^{\circ}C$)

	High Wattage Land Pattern	Standard Land Pattern	Free Air
Power Dissipation	1300mW	900mW	500mW
Thermal Resistance	77°C/W	111°C/W	200°C/W

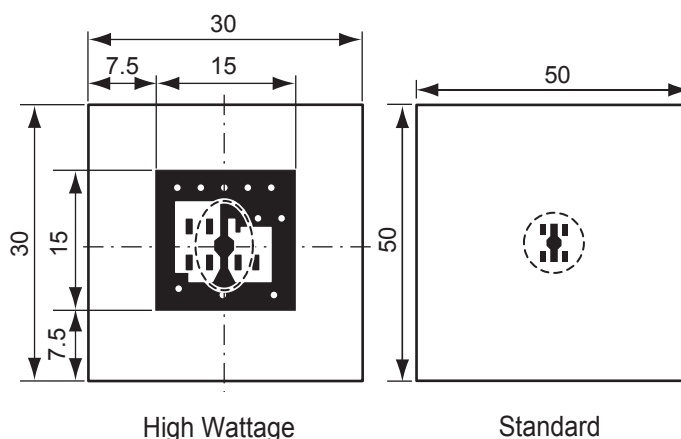
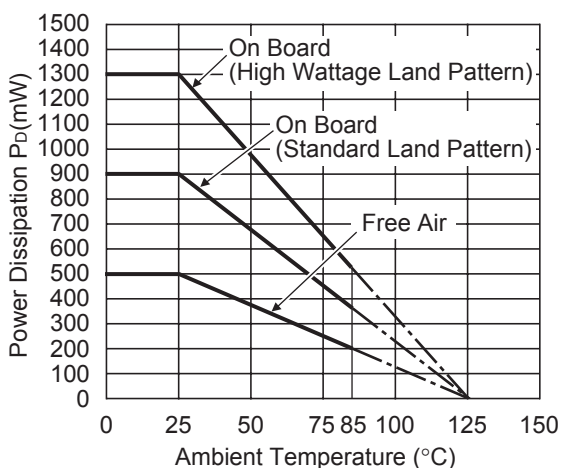

Measurement Board Pattern

○ IC Mount Area (Unit : mm)

RECOMMENDED LAND PATTERN (SOT-89-5)

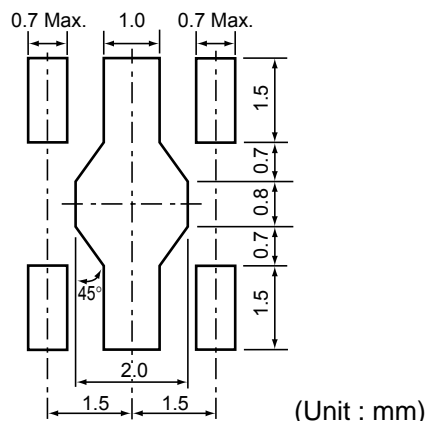

R1154H SERIES MARK SPECIFICATION

• SOT-89-5

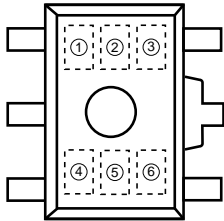

- ① : G (fixed)
- ②, ③, ④ : Product Code } (refer to Part Number vs. Product Code)
- ⑤, ⑥ : Lot Number

• Part Number vs. Product Code

Part Number	Product Code			
	①	②	③	④
R1154H025B	G	0	2	5
R1154H026B	G	0	2	6
R1154H027B	G	0	2	7
R1154H028B	G	0	2	8
R1154H029B	G	0	2	9
R1154H030B	G	0	3	0
R1154H031B	G	0	3	1
R1154H032B	G	0	3	2
R1154H033B	G	0	3	3
R1154H034B	G	0	3	4
R1154H035B	G	0	3	5
R1154H036B	G	0	3	6
R1154H037B	G	0	3	7
R1154H038B	G	0	3	8
R1154H039B	G	0	3	9
R1154H040B	G	0	4	0
R1154H041B	G	0	4	1
R1154H042B	G	0	4	2
R1154H043B	G	0	4	3
R1154H044B	G	0	4	4
R1154H045B	G	0	4	5
R1154H046B	G	0	4	6
R1154H047B	G	0	4	7
R1154H048B	G	0	4	8
R1154H049B	G	0	4	9
R1154H050B	G	0	5	0
R1154H051B	G	0	5	1
R1154H052B	G	0	5	2
R1154H053B	G	0	5	3
R1154H054B	G	0	5	4

Part Number	Product Code			
	①	②	③	④
R1154H055B	G	0	5	5
R1154H056B	G	0	5	6
R1154H057B	G	0	5	7
R1154H058B	G	0	5	8
R1154H059B	G	0	5	9
R1154H060B	G	0	6	0
R1154H061B	G	0	6	1
R1154H062B	G	0	6	2
R1154H063B	G	0	6	3
R1154H064B	G	0	6	4
R1154H065B	G	0	6	5
R1154H066B	G	0	6	6
R1154H067B	G	0	6	7
R1154H068B	G	0	6	8
R1154H069B	G	0	6	9
R1154H070B	G	0	7	0
R1154H071B	G	0	7	1
R1154H072B	G	0	7	2
R1154H073B	G	0	7	3
R1154H074B	G	0	7	4
R1154H075B	G	0	7	5
R1154H076B	G	0	7	6
R1154H077B	G	0	7	7
R1154H078B	G	0	7	8
R1154H079B	G	0	7	9
R1154H080B	G	0	8	0
R1154H081B	G	0	8	1
R1154H082B	G	0	8	2
R1154H083B	G	0	8	3
R1154H084B	G	0	8	4

Part Number	Product Code			
	①	②	③	④
R1154H085B	G	0	8	5
R1154H086B	G	0	8	6
R1154H087B	G	0	8	7
R1154H088B	G	0	8	8
R1154H089B	G	0	8	9
R1154H090B	G	0	9	0
R1154H091B	G	0	9	1
R1154H092B	G	0	9	2
R1154H093B	G	0	9	3
R1154H094B	G	0	9	4
R1154H095B	G	0	9	5
R1154H096B	G	0	9	6
R1154H097B	G	0	9	7
R1154H098B	G	0	9	8
R1154H099B	G	0	9	9
R1154H100B	G	1	0	0
R1154H101B	G	1	0	1
R1154H102B	G	1	0	2
R1154H103B	G	1	0	3
R1154H104B	G	1	0	4
R1154H105B	G	1	0	5
R1154H106B	G	1	0	6
R1154H107B	G	1	0	7
R1154H108B	G	1	0	8
R1154H109B	G	1	0	9
R1154H110B	G	1	1	0
R1154H111B	G	1	1	1
R1154H112B	G	1	1	2
R1154H113B	G	1	1	3
R1154H114B	G	1	1	4

Part Number	Product Code			
	①	②	③	④
R1154H115B	G	1	1	5
R1154H116B	G	1	1	6
R1154H117B	G	1	1	7
R1154H118B	G	1	1	8
R1154H119B	G	1	1	9
R1154H120B	G	1	2	0

R1154H001C	G	0	0	1
------------	---	---	---	---

Компания «Океан Электроники» предлагает заключение долгосрочных отношений при поставках импортных электронных компонентов на взаимовыгодных условиях!

Наши преимущества:

- Поставка оригинальных импортных электронных компонентов напрямую с производств Америки, Европы и Азии, а так же с крупнейших складов мира;
- Широкая линейка поставок активных и пассивных импортных электронных компонентов (более 30 млн. наименований);
- Поставка сложных, дефицитных, либо снятых с производства позиций;
- Оперативные сроки поставки под заказ (от 5 рабочих дней);
- Экспресс доставка в любую точку России;
- Помощь Конструкторского Отдела и консультации квалифицированных инженеров;
- Техническая поддержка проекта, помощь в подборе аналогов, поставка прототипов;
- Поставка электронных компонентов под контролем ВП;
- Система менеджмента качества сертифицирована по Международному стандарту ISO 9001;
- При необходимости вся продукция военного и аэрокосмического назначения проходит испытания и сертификацию в лаборатории (по согласованию с заказчиком);
- Поставка специализированных компонентов военного и аэрокосмического уровня качества (Xilinx, Altera, Analog Devices, Intersil, Interpoint, Microsemi, Actel, Aeroflex, Peregrine, VPT, Syfer, Eurofarad, Texas Instruments, MS Kennedy, Miteq, Cobham, E2V, MA-COM, Hittite, Mini-Circuits, General Dynamics и др.);

Компания «Океан Электроники» является официальным дистрибьютором и эксклюзивным представителем в России одного из крупнейших производителей разъемов военного и аэрокосмического назначения «JONHON», а так же официальным дистрибьютором и эксклюзивным представителем в России производителя высокотехнологичных и надежных решений для передачи СВЧ сигналов «FORSTAR».



JONHON

«JONHON» (основан в 1970 г.)

Разъемы специального, военного и аэрокосмического назначения:

(Применяются в военной, авиационной, аэрокосмической, морской, железнодорожной, горно- и нефтедобывающей отраслях промышленности)

«FORSTAR» (основан в 1998 г.)

ВЧ соединители, коаксиальные кабели,
кабельные сборки и микроволновые компоненты:

(Применяются в телекоммуникациях гражданского и специального назначения, в средствах связи, РЛС, а так же военной, авиационной и аэрокосмической отраслях промышленности).



Телефон: 8 (812) 309-75-97 (многоканальный)

Факс: 8 (812) 320-03-32

Электронная почта: ocean@oceanchips.ru

Web: <http://oceanchips.ru/>

Адрес: 198099, г. Санкт-Петербург, ул. Калинина, д. 2, корп. 4, лит. А