

Circuit Breaker for Equipment thermal, Snap-in type, Reset type, Quick connect terminals



See below:

**Approvals and Compliances**

**Description**

- Snap-in version
- Thermal circuit breaker
- 1-pole
- Reset type
- Quick connect terminals 6.3 x 0.8 mm

**Unique Selling Proposition**

- Compact design
- Positively trip-free release
- Available with cover
- Different mounting possibilities

**Applications**

- Power tools
- Household Equipment
- Power supplies and chargers
- Industrial appliances

**Weblinks**

[pdf data sheet](#), [html datasheet](#), [General Product Information](#), [Distributor-Stock-Check](#), [Detailed request for product](#), [Product News](#)

**Technical Data**

|  |  |                           |  |
|--|--|---------------------------|--|
| Rated Voltage AC                                   | AC 240 VAC   | Overload                  | IEC: min. 40 trips<br>@ 6 x I <sub>r</sub> , cos φ 0.6   |
| Rated Voltage DC                                   | 48 VDC   |                           | UL / CSA: min. 50 trips<br>@ 1.5 x I <sub>r</sub> , cos φ 0.75   |
| Rated current range AC                             | 0.05 - 16 A  | Allowable Operation Temp. | -5 °C to 60 °C   |
| Conditional short circuit capacity I <sub>nc</sub> | IEC 60934: PC1, AC 240 V: 2 kA   | Vibration Resistance      | ± 1.5 mm @ 10 - 60 Hz<br>acc. to IEC 60068-2-6, test Fc<br>5 G @ 60 - 500 Hz<br>acc. to IEC 60068-2-6, test Fc |
| Short circuit capacity I <sub>cn</sub>             | IEC 60934: at I <sub>n</sub> < 6.5 A/240 VAC : 8 x I <sub>n</sub><br>IEC 60934: at I <sub>n</sub> ≥ 6.5 A/240 VAC : 96 A | Shock Resistance          | 100 G / 6ms<br>acc. to IEC 60068-2-27, test Ea   |
| Degree of Protection                               | from front side IP40 acc. to IEC 60529   | Tripping Type             | Thermal  |
| Dielectric Strength                                | 50Hz: > 1.5 kV<br>Impulse 1.2/50 μs: > 2.5 kV  | Actuation Type            | Reset type   |
| Insulation Resistance                              | 500VDC > 100 MΩ  | Weight                    | ca. 10g  |
| Endurance typical                                  | 2 x I <sub>r</sub> : 500 switching cycles  |                           |  |
| Endurance minimum                                  | Reset type<br>AC : 2 x I <sub>r</sub> , cos φ 0.6 :<br>DC : 2 x I <sub>r</sub> , L/R = 2 - 3 ms :<br>50 switching cycles |                           |  |

**Approvals and Compliances**

Detailed information on product approvals, code requirements, usage instructions and detailed test conditions can be looked up in [Details about Approvals](#)

SCHURTER products are designed for use in industrial environments. They have approvals from independent testing bodies according to national and international standards. Products with specific characteristics and requirements such as required in the automotive sector according to IATF 16949, medical technology according to ISO 13485 or in the aerospace industry can be offered exclusively with customer-specific, individual agreements by SCHURTER.

## Approvals

The approval mark is used by the testing authorities to certify compliance with the safety requirements placed on electronic products.

Approval Reference Type: T11

| Approval Logo  | Certificates                  | Certification Body | Description                              |
|--|-------------------------------|--------------------|--|
|  | <a href="#">VDE Approvals</a> | VDE                | VDE Certificate Number: 99759            |
|  | <a href="#">UL Approvals</a>  | UL                 | UL File Number: E71572                   |
|  | <a href="#">CCC Approvals</a> | CCC                | CCC Certificate Number: 2020970307003506 |

## Product standards

Product standards that are referenced

| Organization   | Design                | Standard          | Description   |
|--|-----------------------|-------------------|---|
|  | Designed according to | IEC 60934         | Circuit-breakers for equipment (CBE)                                  |
|  | Designed according to | UL 1077           | Standard for Supplementary Protectors for Use in Electrical Equipment |
|  | Designed according to | CSA C22.2 No. 235 | Supplementary Protectors  |
|  | Designed according to | GB 17701          | Circuit-breaker for equipment   |





## Application standards

Application standards where the product can be used

| Organization  | Design                         | Standard       | Description  |
|---|--------------------------------|----------------|--|
|  | Designed for applications acc. | IEC/UL 62368-1 | IEC 62368-1 includes the basic requirements for safety of audio, video, information technology and office equipment. |

## Compliances

The product complies with following Guide Lines

| Identification   | Details                                      | Initiator   | Description   |
|--|--|-------------|---|
|  | <a href="#">CE declaration of conformity</a> | SCHURTER AG | The CE marking declares that the product complies with the applicable requirements laid down in the harmonisation of Community legislation on its affixing in accordance with EU Regulation 765/2008. |
|  | RoHS   | SCHURTER AG | Directive RoHS 2011/65/EU, Amendment (EU) 2015/863  |
|  | China RoHS                                   | SCHURTER AG | The law SJ / T 11363-2006 (China RoHS) has been in force since 1 March 2007. It is similar to the EU directive RoHS.  |
|  | REACH  | SCHURTER AG | On 1 June 2007, Regulation (EC) No 1907/2006 on the Registration, Evaluation, Authorization and Restriction of Chemicals 1 (abbreviated as "REACH") entered into force.                               |

Dimension [mm]

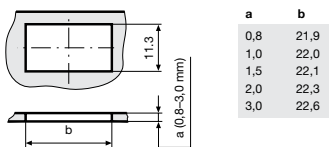
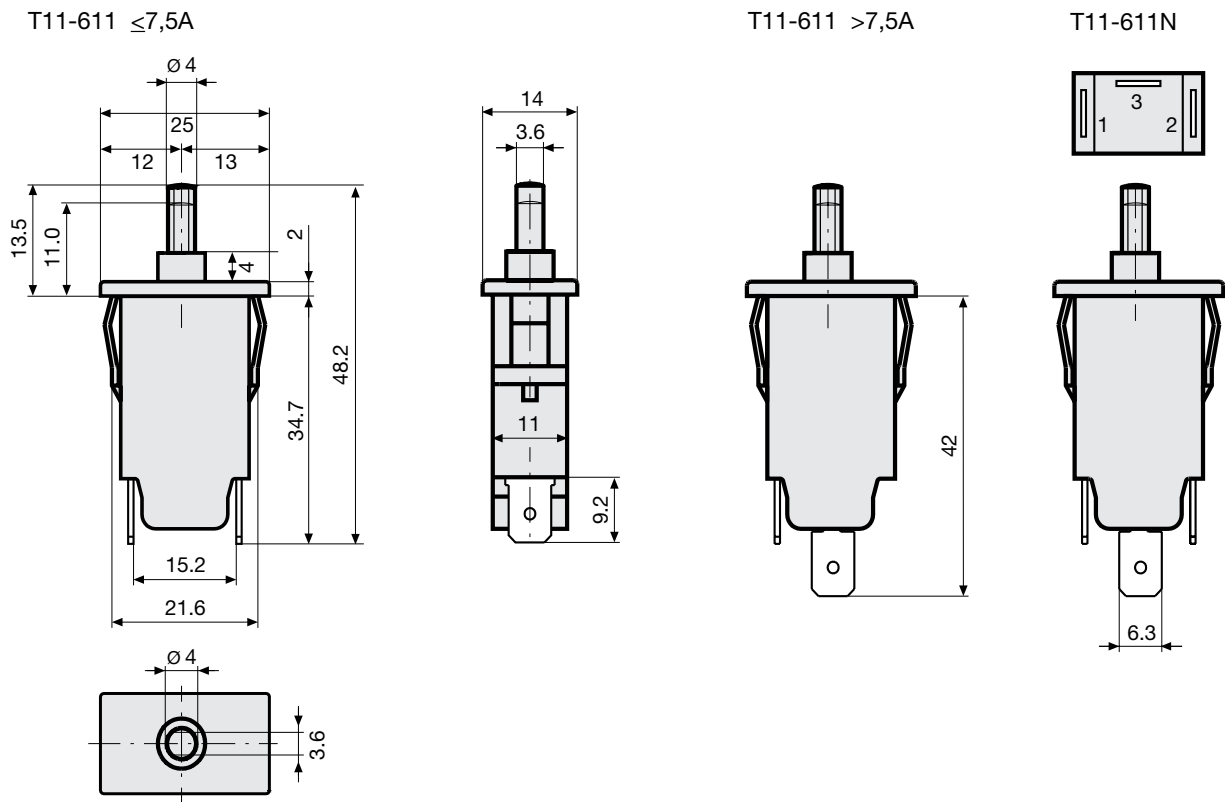

Diagrams

Rated current  $\leq 7,5$  A

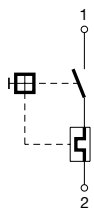

Rated current  $> 7,5$  A

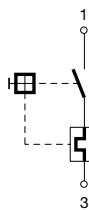

Shunt terminal T11-...N  $\leq 6,5$  A

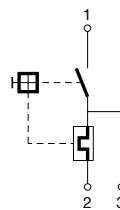

Typical internal resistance per pole

| Rated Current [A] | Internal Resistance [ $\Omega$ ] |
|-------------------|----------------------------------|
| 0.05              | 380.000                          |
| 0.50              | 5.200                            |
| 1.00              | 1.350                            |
| 2.00              | 0.300                            |
| 3.00              | 0.130                            |
| 4.00              | 0.080                            |
| 5.00              | 0.040                            |
| 6.00              | 0.040                            |
| 7.00              | 0.020                            |
| 8.00              | 0.012                            |
| 9.00              | 0.012                            |
| 10.00             | 0.011                            |
| 11.00             | 0.0095                           |
| 12.00             | 0.0095                           |
| 13.00             | 0.0085                           |
| 14.00             | 0.0085                           |
| 15.00             | 0.0075                           |
| 16.00             | 0.0075                           |

Time-Current-Curves

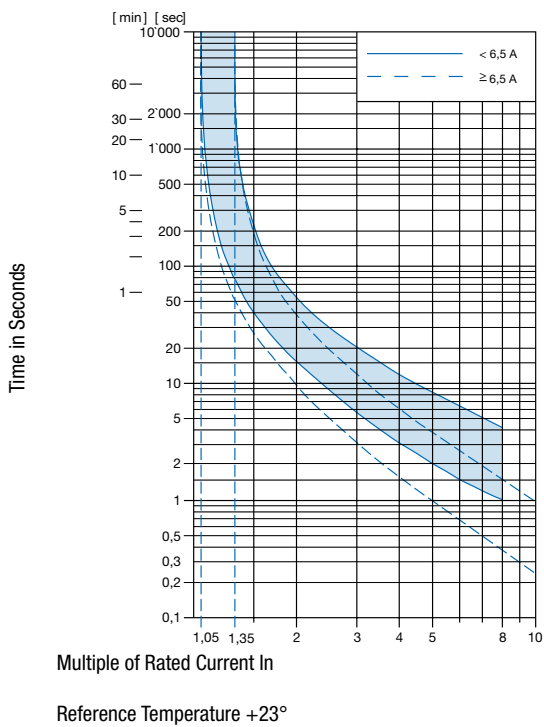

### Effect of ambient temperature

The units are calibrated for an ambient temperature of +23°C. To determine the rated current for a lower or higher ambient temperature, use a correction factor (typical value) from the table below:

| Ambient Temperature [°C] | Correction factor |
|--------------------------|-------------------|
| -5                       | 0.87              |
| 0                        | 0.90              |
| +10                      | 0.95              |
| +23                      | 1.00              |
| +30                      | 1.04              |
| +40                      | 1.10              |
| +50                      | 1.15              |
| +60                      | 1.20              |

Example: Rated current = 5 A, Environmental temperature = 40 °C, --> Correction factor = 1.1, Resulting current = 5.5 A --> Fount to next higher rated current: 6 A

### Config. Code

T11 - 1 2 3 A B - 1.23

The characters are placeholders for the correspondingly keys of selections from the key tables.

#### T11 - 1 2 3 A B - 1.23 = Mounting

| Mounting                         | Configuration key |
|----------------------------------|-------------------|
| Snap-in mounting from front side | 6                 |

#### T11 - 1 2 3 A B - 1.23 = Actuation Type

| Actuation Type | Configuration key |
|----------------|-------------------|
| Reset type     | 1                 |

#### T11 - 1 2 3 A B - 1.23 = Terminal

| Terminal                         | Configuration key |
|----------------------------------|-------------------|
| Quick connect terminal 6.3x0.8mm | 1                 |

#### T11 - 1 2 3 A B - 1.23 = Shunt terminal

| Shunt terminal | Configuration key |
|----------------|-------------------|
| Shunt terminal | N                 |

#### T11 - 1 2 3 A B - 1.23 = Setting indication

| Setting indication | Configuration key |
|--------------------|-------------------|
| Setting indication | R                 |

#### T11 - 1 2 3 A B - 1.23 = Rated current

| Rated current | Configuration key |
|---------------|-------------------|
| 0.05 A        | 0.05              |
| 0.1 A         | 0.1               |
| 0.15 A        | 0.15              |
| 0.2 A         | 0.2               |
| 0.3 A         | 0.3               |
| 0.4 A         | 0.4               |
| 0.5 A         | 0.5               |
| 0.6 A         | 0.6               |
| 0.7 A         | 0.7               |

Other rated currents on request

| Rated current | Configuration key |
|---------------|-------------------|
| 0.8 A         | 0.8               |
| 0.9 A         | 0.9               |
| 1.0           | 1                 |
| 1.1 A         | 1.1               |
| 1.2 A         | 1.2               |
| 1.3 A         | 1.3               |
| 1.4 A         | 1.4               |
| 1.5 A         | 1.5               |
| 1.6 A         | 1.6               |
| 1.7 A         | 1.7               |
| 1.8 A         | 1.8               |
| 1.9 A         | 1.9               |
| 2.0 A         | 2                 |
| 2.1 A         | 2.1               |
| 2.3 A         | 2.3               |
| 2.5 A         | 2.5               |
| 2.8 A         | 2.8               |
| 3.0 A         | 3                 |
| 3.3 A         | 3.3               |
| 3.5 A         | 3.5               |
| 4.0 A         | 4                 |
| 4.5 A         | 4.5               |
| 5.0 A         | 5                 |
| 5.5 A         | 5.5               |
| 6.0           | 6                 |
| 6.5 A         | 6.5               |
| 7.0 A         | 7                 |
| 7.5 A         | 7.5               |
| 8.0 A         | 8                 |
| 8.5 A         | 8.5               |
| 9.0 A         | 9                 |
| 9.5 A         | 9.5               |
| 10.0 A        | 10                |
| 11.0 A        | 11                |
| 12.0 A        | 12                |

Other rated currents on request

| Rated current                   | Configuration key | Rated current                   | Configuration key |
|---------------------------------|-------------------|---------------------------------|-------------------|
| 13.0 A                          | 13                | 15.0 A                          | 15                |
| 14.0 A                          | 14                | 16.0 A                          | 16                |
| Other rated currents on request |                   | Other rated currents on request |                   |

## Variants

| Rated current | Construction variants |                    | Config. Code | Order Number              |
|---------------|-----------------------|--------------------|--------------|---------------------------|
|               | Shunt terminal        | Setting indication |              |                           |
| 2.0 A         |                       |                    | T11-611-2    | <a href="#">4400.0002</a> |
| 10.0 A        |                       |                    | T11-611-10   | <a href="#">4400.0030</a> |
| 16.0 A        |                       |                    | T11-611-16   | <a href="#">4400.0034</a> |
| 3.5 A         |                       |                    | T11-611-3.5  | <a href="#">4400.0200</a> |

 Most Popular.

Availability for all products can be searched real-time: <https://www.schurter.com/en/Stock-Check/Stock-Check-SCHURTER>

**Packaging Unit** 100 Pcs

Компания «Океан Электроники» предлагает заключение долгосрочных отношений при поставках импортных электронных компонентов на взаимовыгодных условиях!

Наши преимущества:

- Поставка оригинальных импортных электронных компонентов напрямую с производств Америки, Европы и Азии, а так же с крупнейших складов мира;
- Широкая линейка поставок активных и пассивных импортных электронных компонентов (более 30 млн. наименований);
- Поставка сложных, дефицитных, либо снятых с производства позиций;
- Оперативные сроки поставки под заказ (от 5 рабочих дней);
- Экспресс доставка в любую точку России;
- Помощь Конструкторского Отдела и консультации квалифицированных инженеров;
- Техническая поддержка проекта, помощь в подборе аналогов, поставка прототипов;
- Поставка электронных компонентов под контролем ВП;
- Система менеджмента качества сертифицирована по Международному стандарту ISO 9001;
- При необходимости вся продукция военного и аэрокосмического назначения проходит испытания и сертификацию в лаборатории (по согласованию с заказчиком);
- Поставка специализированных компонентов военного и аэрокосмического уровня качества (Xilinx, Altera, Analog Devices, Intersil, Interpoint, Microsemi, Actel, Aeroflex, Peregrine, VPT, Syfer, Eurofarad, Texas Instruments, MS Kennedy, Miteq, Cobham, E2V, MA-COM, Hittite, Mini-Circuits, General Dynamics и др.);

Компания «Океан Электроники» является официальным дистрибьютором и эксклюзивным представителем в России одного из крупнейших производителей разъемов военного и аэрокосмического назначения «JONHON», а так же официальным дистрибьютором и эксклюзивным представителем в России производителя высокотехнологичных и надежных решений для передачи СВЧ сигналов «FORSTAR».



## JONHON

«JONHON» (основан в 1970 г.)

Разъемы специального, военного и аэрокосмического назначения:

(Применяются в военной, авиационной, аэрокосмической, морской, железнодорожной, горно- и нефтедобывающей отраслях промышленности)

«FORSTAR» (основан в 1998 г.)

ВЧ соединители, коаксиальные кабели, кабельные сборки и микроволновые компоненты:

(Применяются в телекоммуникациях гражданского и специального назначения, в средствах связи, РЛС, а так же военной, авиационной и аэрокосмической отраслях промышленности).



Телефон: 8 (812) 309-75-97 (многоканальный)

Факс: 8 (812) 320-03-32

Электронная почта: [ocean@oceanchips.ru](mailto:ocean@oceanchips.ru)

Web: <http://oceanchips.ru/>

Адрес: 198099, г. Санкт-Петербург, ул. Калинина, д. 2, корп. 4, лит. А