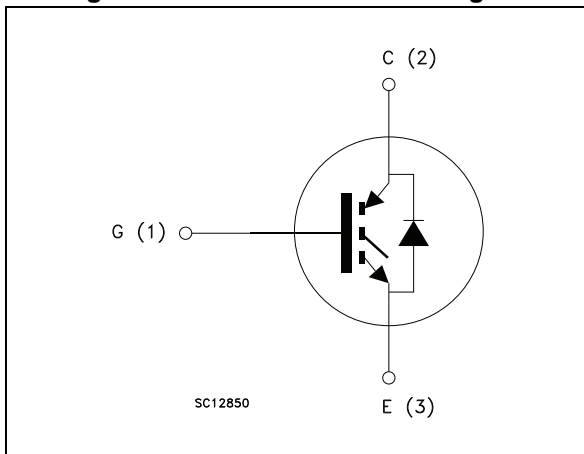

Figure 1. Internal schematic diagram



Features

- Maximum junction temperature: $T_J = 175\text{ °C}$
- High speed switching series
- Minimized tail current
- $V_{CE(sat)} = 2.1\text{ V (typ.) @ } I_C = 25\text{ A}$
- $5\text{ }\mu\text{s}$ minimum short circuit withstand time at $T_J=150\text{ °C}$
- Safe paralleling
- Very fast recovery antiparallel diode
- Low thermal resistance

Applications

- Uninterruptible power supply
- Welding machines
- Photovoltaic inverters
- Power factor correction
- High frequency converters

Description

These devices are IGBTs developed using an advanced proprietary trench gate field-stop structure. These devices are part of the H series of IGBTs, which represent an optimum compromise between conduction and switching losses to maximize the efficiency of high switching frequency converters. Moreover, a slightly positive $V_{CE(sat)}$ temperature coefficient and very tight parameter distribution result in safer paralleling operation.

Table 1. Device summary

Order code	Marking	Package	Packaging
STGW25H120DF2	G25H120DF2	TO-247	Tube
STGWA25H120DF2	G25H120DF2	TO-247 long leads	Tube

Contents

1	Electrical ratings	3
2	Electrical characteristics	4
	2.1 Electrical characteristics (curves)	6
3	Test circuits	11
4	Package information	12
	4.1 TO-247, package information	12
	4.2 TO-247 long leads, package information	14
5	Revision history	16

1 Electrical ratings

Table 2. Absolute maximum ratings

Symbol	Parameter	Value	Unit
V_{CES}	Collector-emitter voltage ($V_{GE} = 0$)	1200	V
I_C	Continuous collector current at $T_C = 25\text{ °C}$	50	A
	Continuous collector current at $T_C = 100\text{ °C}$	25	A
$I_{CP}^{(1)}$	Pulsed collector current	100	A
V_{GE}	Gate-emitter voltage	± 20	V
I_F	Continuous collector current at $T_C = 25\text{ °C}$	50	A
	Continuous collector current at $T_C = 100\text{ °C}$	25	A
$I_{FP}^{(1)}$	Pulsed forward current	100	A
P_{TOT}	Total dissipation at $T_C = 25\text{ °C}$	375	W
T_J	Operating junction temperature	- 55 to 175	°C
T_{STG}	Storage temperature range	- 55 to 150	

1. Pulse width limited by maximum junction temperature.

Table 3. Thermal data

Symbol	Parameter	Value	Unit
R_{thJC}	Thermal resistance junction-case IGBT	0.4	°C/W
R_{thJC}	Thermal resistance junction-case diode	1.47	°C/W
R_{thJA}	Thermal resistance junction-ambient	50	°C/W

2 Electrical characteristics

$T_J = 25\text{ °C}$ unless otherwise specified.

Table 4. Static characteristics

Symbol	Parameter	Test conditions	Min.	Typ.	Max.	Unit
$V_{(BR)CES}$	Collector-emitter breakdown voltage ($V_{GE} = 0$)	$I_C = 2\text{ mA}$	1200			V
$V_{CE(sat)}$	Collector-emitter saturation voltage	$V_{GE} = 15\text{ V}, I_C = 25\text{ A}$		2.1	2.6	V
		$V_{GE} = 15\text{ V}, I_C = 25\text{ A}$ $T_J = 125\text{ °C}$		2.4		
		$V_{GE} = 15\text{ V}, I_C = 25\text{ A}$ $T_J = 175\text{ °C}$		2.5		
V_F	Forward on-voltage	$I_F = 25\text{ A}$		3.8	4.9	V
		$I_F = 25\text{ A}, T_J = 125\text{ °C}$		3.05		
		$I_F = 25\text{ A}, T_J = 175\text{ °C}$		2.8		
$V_{GE(th)}$	Gate threshold voltage	$V_{CE} = V_{GE}, I_C = 1\text{ mA}$	5	6	7	V
I_{CES}	Collector cut-off current ($V_{GE} = 0$)	$V_{CE} = 1200\text{ V}$			25	μA
I_{GES}	Gate-emitter leakage current ($V_{CE} = 0$)	$V_{GE} = \pm 20\text{ V}$			250	nA

Table 5. Dynamic characteristics

Symbol	Parameter	Test conditions	Min.	Typ.	Max.	Unit
C_{ies}	Input capacitance	$V_{CE} = 25\text{ V}, f = 1\text{ MHz},$ $V_{GE} = 0$	-	2010	-	pF
C_{oes}	Output capacitance		-	146	-	pF
C_{res}	Reverse transfer capacitance		-	49	-	pF
Q_g	Total gate charge	$V_{CC} = 960\text{ V}, I_C = 25\text{ A},$ $V_{GE} = 15\text{ V},$ see Figure 29	-	100	-	nC
Q_{ge}	Gate-emitter charge		-	11	-	nC
Q_{gc}	Gate-collector charge		-	52	-	nC

Table 6. IGBT switching characteristics (inductive load)

Symbol	Parameter	Test conditions	Min.	Typ.	Max.	Unit
$t_{d(on)}$	Turn-on delay time	$V_{CE} = 600\text{ V}$, $I_C = 25\text{ A}$, $R_G = 10\ \Omega$, $V_{GE} = 15\text{ V}$, see Figure 28	-	29	-	ns
t_r	Current rise time		-	12	-	ns
$(di/dt)_{on}$	Turn-on current slope		-	1774	-	A/ μs
$t_{d(off)}$	Turn-off delay time		-	130	-	ns
t_f	Current fall time		-	106	-	ns
$E_{on}^{(1)}$	Turn-on switching losses		-	0.6	-	mJ
$E_{off}^{(2)}$	Turn-off switching losses		-	0.7	-	mJ
E_{ts}	Total switching losses		-	1.3	-	mJ
$t_{d(on)}$	Turn-on delay time	$V_{CE} = 600\text{ V}$, $I_C = 25\text{ A}$, $R_G = 10\ \Omega$, $V_{GE} = 15\text{ V}$, $T_J = 175\text{ }^\circ\text{C}$, see Figure 28	-	27.5	-	ns
t_r	Current rise time		-	13.5	-	ns
$(di/dt)_{on}$	Turn-on current slope		-	1522	-	A/ μs
$t_{d(off)}$	Turn-off delay time		-	139	-	ns
t_f	Current fall time		-	200	-	ns
$E_{on}^{(1)}$	Turn-on switching losses		-	1.05	-	mJ
$E_{off}^{(2)}$	Turn-off switching losses		-	1.65	-	mJ
E_{ts}	Total switching losses		-	2.7	-	mJ
t_{sc}	Short-circuit withstand time	$V_{CE} = 600\text{ V}$, $V_{GE} = 15\text{ V}$, $T_J = 150\text{ }^\circ\text{C}$,	5		-	μs

1. Energy losses include reverse recovery of the external diode.
2. Turn-off losses include also the tail of the collector current.

Table 7. Diode switching characteristics (inductive load)

Symbol	Parameter	Test conditions	Min.	Typ.	Max.	Unit
t_{rr}	Reverse recovery time	$I_F = 25\text{ A}$, $V_R = 600\text{ V}$, $di/dt = 500\text{ A}/\mu\text{s}$, $V_{GE} = 15\text{ V}$, see Figure 28	-	303	-	ns
Q_{rr}	Reverse recovery charge		-	0.93	-	μC
I_{rrm}	Reverse recovery current		-	15.3	-	A
dl_{rr}/dt	Peak rate of fall of reverse recovery current during t_b		-	400	-	A/ μs
E_{rr}	Reverse recovery energy		-	0.52	-	mJ
t_{rr}	Reverse recovery time	$I_F = 25\text{ A}$, $V_R = 600\text{ V}$, $di/dt = 500\text{ A}/\mu\text{s}$, $V_{GE} = 15\text{ V}$, $T_J = 175\text{ }^\circ\text{C}$, see Figure 28	-	508	-	ns
Q_{rr}	Reverse recovery charge		-	2.71	-	μC
I_{rrm}	Reverse recovery current		-	23	-	A
dl_{rr}/dt	Peak rate of fall of reverse recovery current during t_b		-	680	-	A/ μs
E_{rr}	Reverse recovery energy		-	1.56	-	mJ

2.1 Electrical characteristics (curves)

Figure 2. Power dissipation vs. case temperature



Figure 3. Collector current vs. case temperature



Figure 4. Output characteristics (T_J = 25°C)



Figure 5. Output characteristics (T_J = 175°C)



Figure 6. V_{CE(sat)} vs. junction temperature



Figure 7. V_{CE(sat)} vs. collector current



Figure 8. Collector current vs. switching frequency

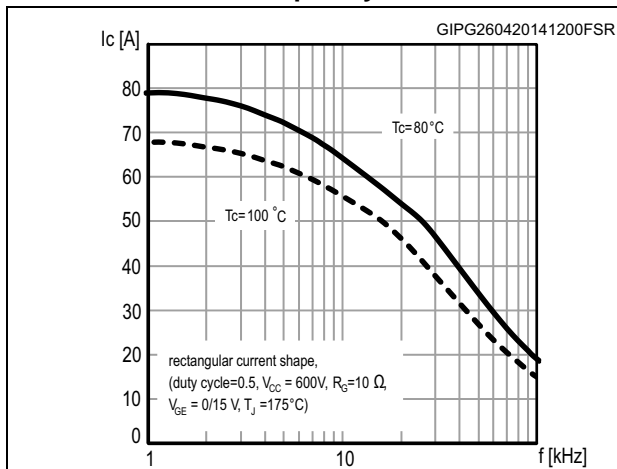

Figure 9. Forward bias safe operating area

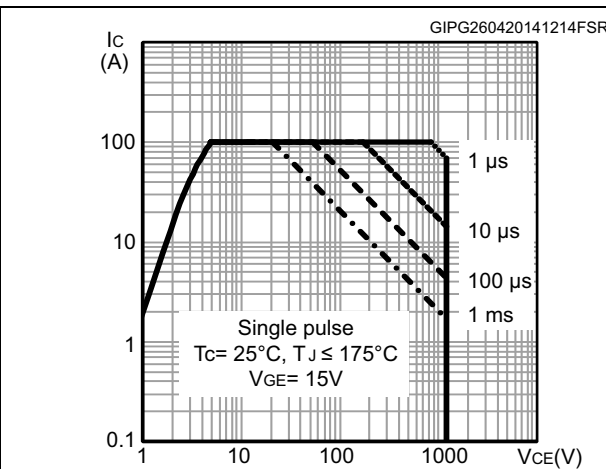

Figure 10. Transfer characteristics

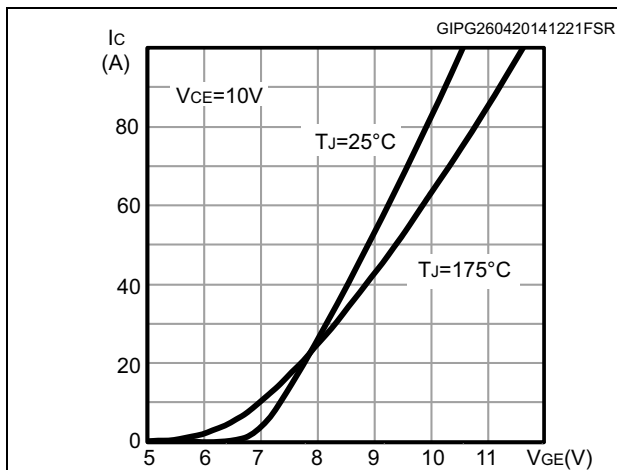

Figure 11. Normalized VGE(th) vs junction temperature

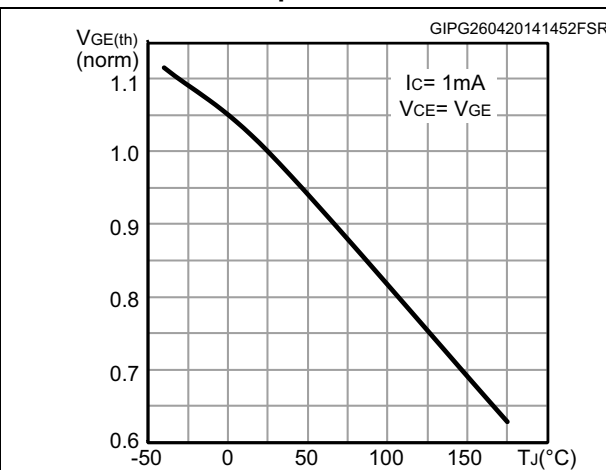

Figure 12. Normalized V(BR)CES vs. junction temperature

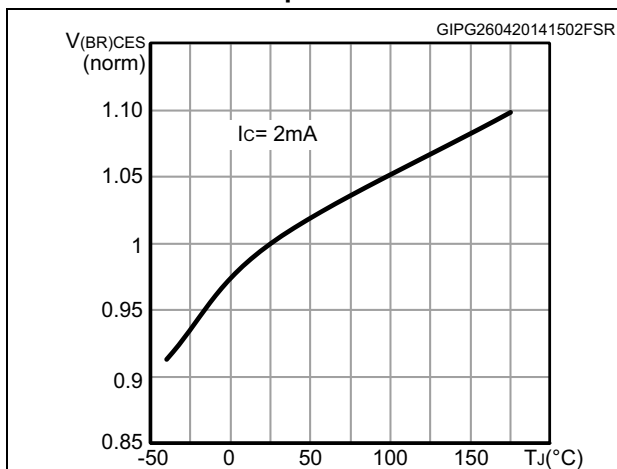

Figure 13. Capacitance variation

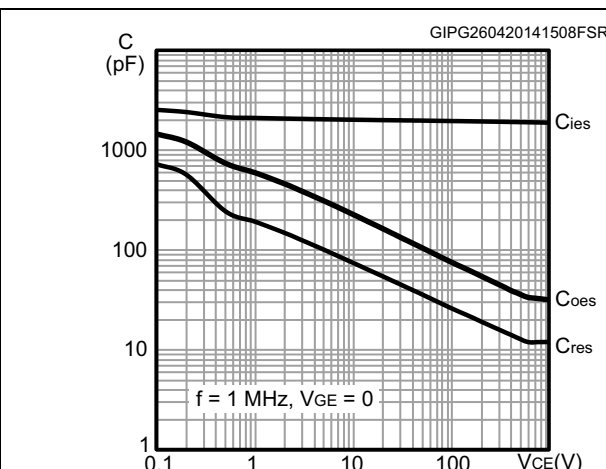

Figure 14. Gate charge vs. gate-emitter voltage



Figure 15. Switching loss vs collector current



Figure 16. Switching loss vs gate resistance



Figure 17. Switching loss vs temperature



Figure 18. Switching loss vs collector-emitter voltage



Figure 19. Switching times vs. collector current



Figure 20. Switching times vs. gate resistance

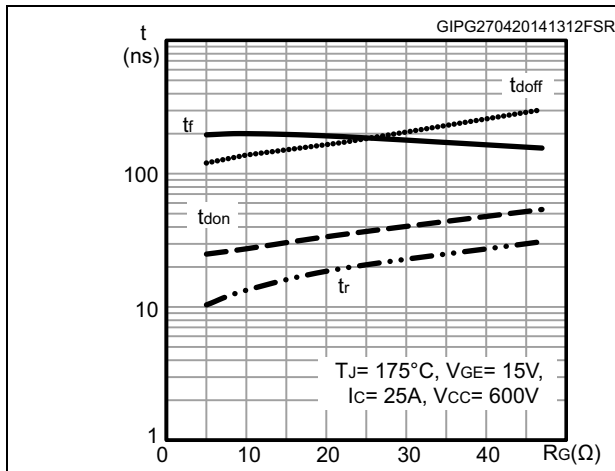

Figure 21. Reverse recovery current vs. diode current slope

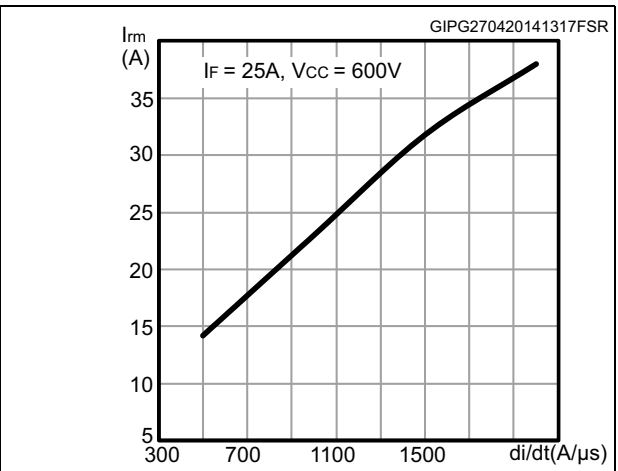

Figure 22. Reverse recovery time vs. diode current slope

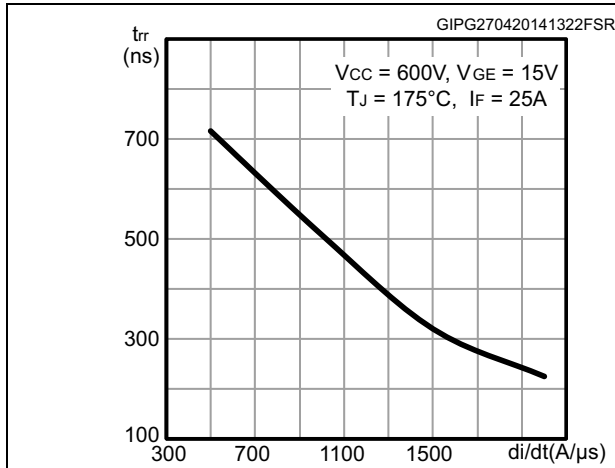

Figure 23. Reverse recovery charge vs. diode current slope

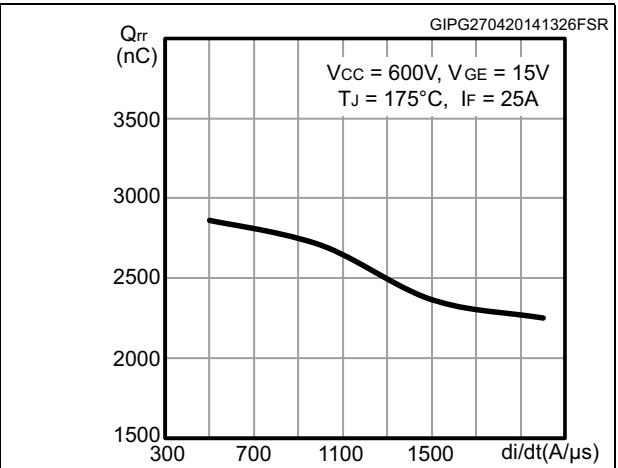

Figure 24. Reverse recovery energy vs. diode current slope

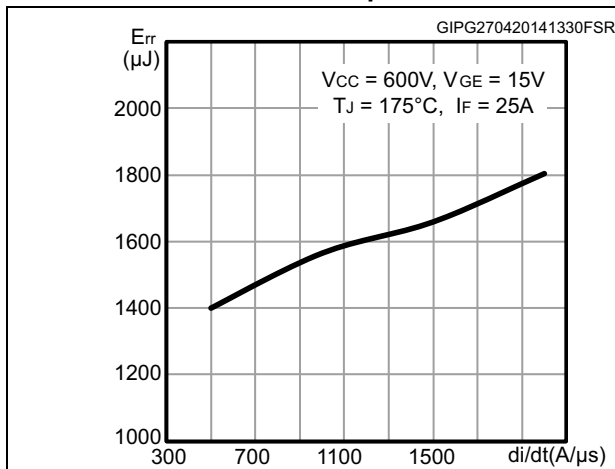

Figure 25. Diode V_F vs. forward current

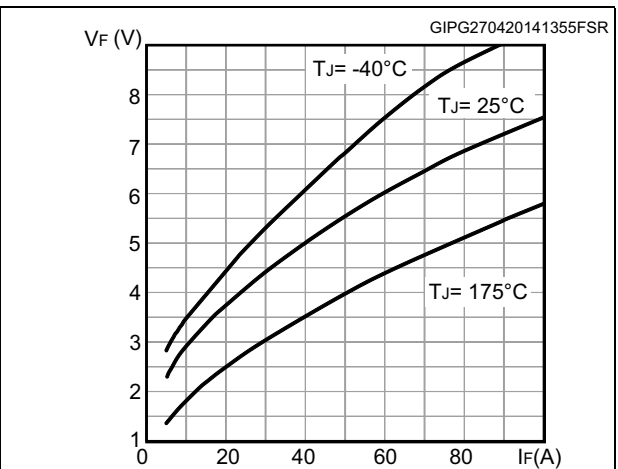

Figure 26. Thermal impedance for IGBT

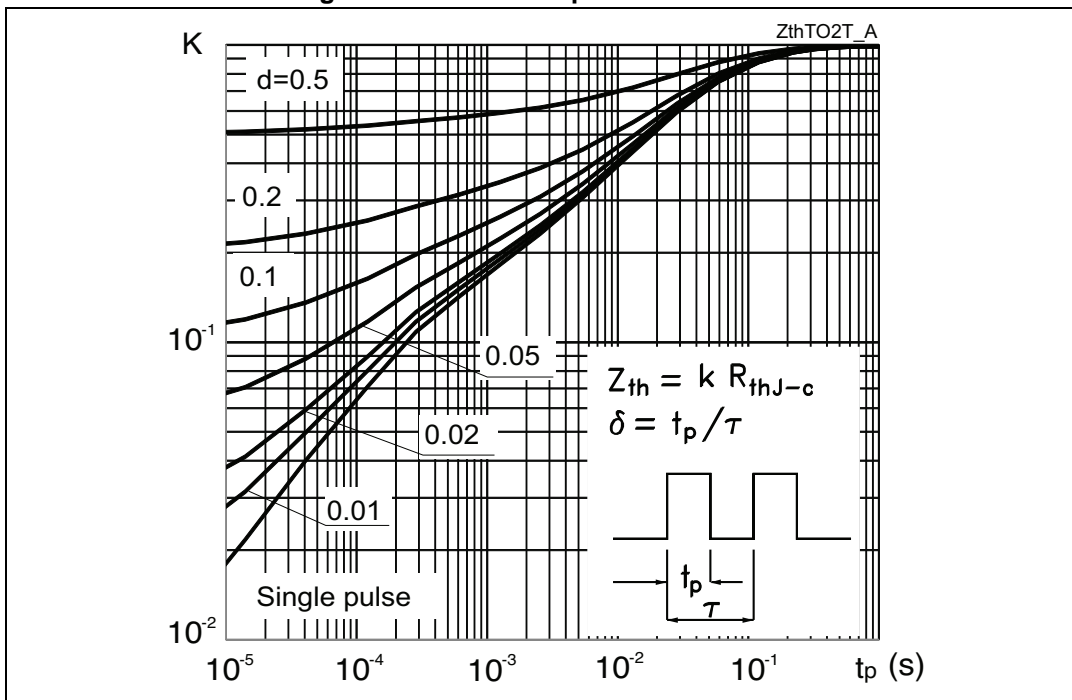
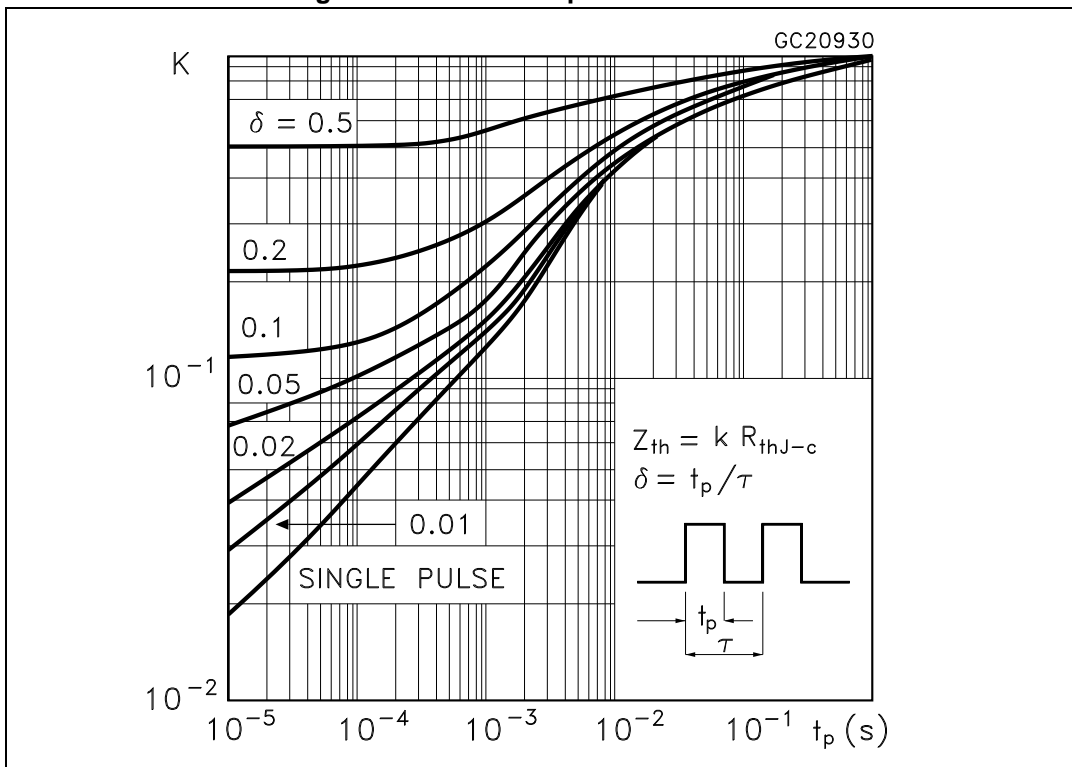

Figure 27. Thermal impedance for diode



4 Package information

In order to meet environmental requirements, ST offers these devices in different grades of ECOPACK® packages, depending on their level of environmental compliance. ECOPACK® specifications, grade definitions and product status are available at: www.st.com. ECOPACK® is an ST trademark.

4.1 TO-247, package information

Figure 32. TO-247 outline

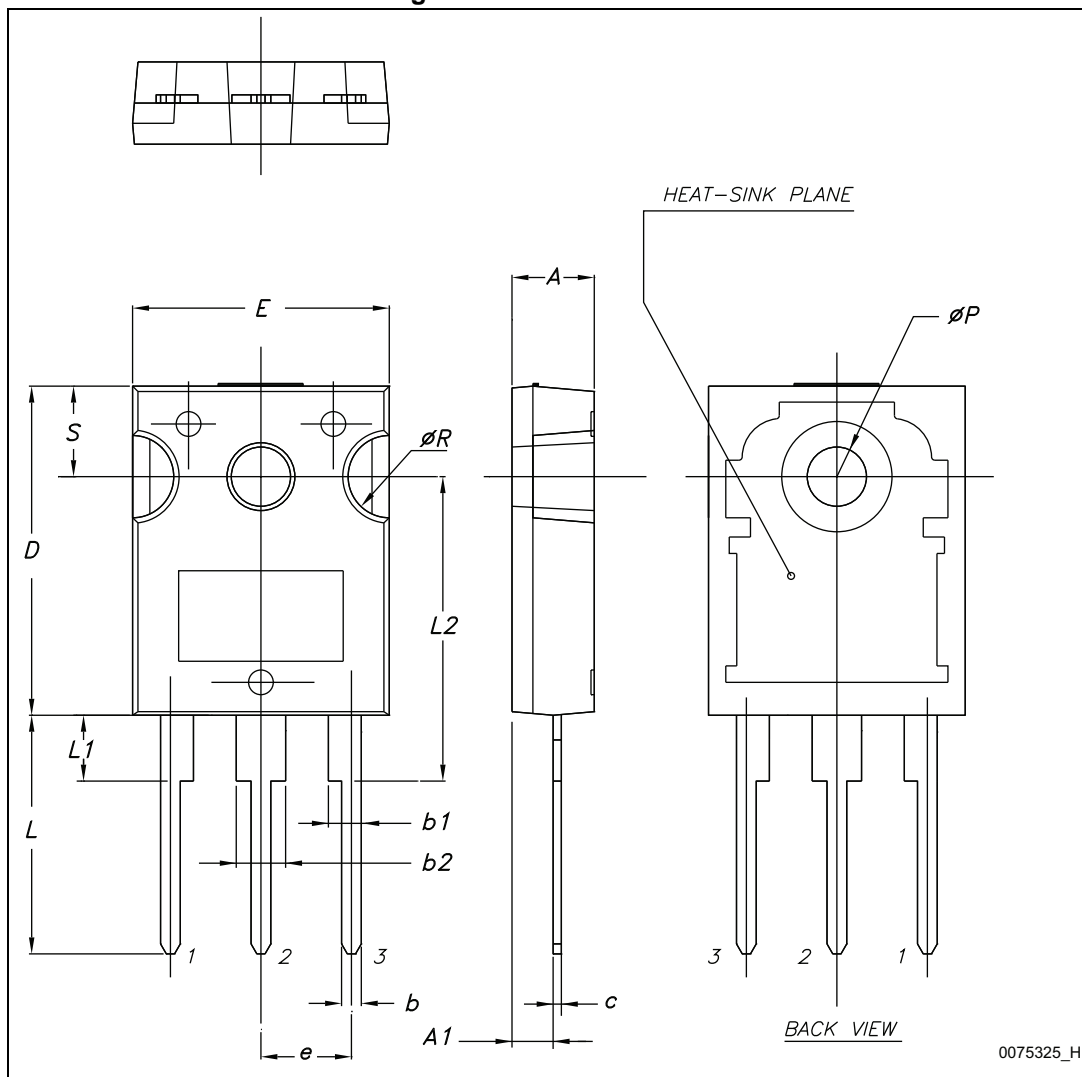

Table 8. TO-247 mechanical data

Dim.	mm.		
	Min.	Typ.	Max.
A	4.85		5.15
A1	2.20		2.60
b	1.0		1.40
b1	2.0		2.40
b2	3.0		3.40
c	0.40		0.80
D	19.85		20.15
E	15.45		15.75
e	5.30	5.45	5.60
L	14.20		14.80
L1	3.70		4.30
L2		18.50	
ØP	3.55		3.65
ØR	4.50		5.50
S	5.30	5.50	5.70

4.2 TO-247 long leads, package information

Figure 33. TO-247 long leads outline



8463846_A_F

Table 9. TO-247 long leads mechanical data

Dim.	mm		
	Min.	Typ.	Max.
A	4.90	5.00	5.10
A1	2.31	2.41	2.51
A2	1.90	2.00	2.10
b	1.16		1.26
b2			3.25
b3			2.25
c	0.59		0.66
D	20.90	21.00	21.10
E	15.70	15.80	15.90
E2	4.90	5.00	5.10
E3	2.40	2.50	2.60
e	5.34	5.44	5.54
L	19.80	19.92	20.10
L1			4.30
P	3.50	3.60	3.70
Q	5.60		6.00
S	6.05	6.15	6.25

5 Revision history

Table 10. Document revision history

Date	Revision	Changes
03-Oct-2012	1	Initial release.
28-Feb-2014	2	Updated title and features in cover page. Minor text changes.
31-Mar-2014	3	Document status promoted from preliminary to production data. Updated Table 4: Static characteristics and Table 6: IGBT switching characteristics (inductive load) . Added Section 2.1: Electrical characteristics (curves) .
06-Mar-2015	4	Added 4.2: TO-247 long leads, package information Minor text changes.

IMPORTANT NOTICE – PLEASE READ CAREFULLY

STMicroelectronics NV and its subsidiaries ("ST") reserve the right to make changes, corrections, enhancements, modifications, and improvements to ST products and/or to this document at any time without notice. Purchasers should obtain the latest relevant information on ST products before placing orders. ST products are sold pursuant to ST's terms and conditions of sale in place at the time of order acknowledgement.

Purchasers are solely responsible for the choice, selection, and use of ST products and ST assumes no liability for application assistance or the design of Purchasers' products.

No license, express or implied, to any intellectual property right is granted by ST herein.

Resale of ST products with provisions different from the information set forth herein shall void any warranty granted by ST for such product.

ST and the ST logo are trademarks of ST. All other product or service names are the property of their respective owners.

Information in this document supersedes and replaces information previously supplied in any prior versions of this document.

© 2015 STMicroelectronics – All rights reserved



Компания «Океан Электроники» предлагает заключение долгосрочных отношений при поставках импортных электронных компонентов на взаимовыгодных условиях!

Наши преимущества:

- Поставка оригинальных импортных электронных компонентов напрямую с производств Америки, Европы и Азии, а так же с крупнейших складов мира;
- Широкая линейка поставок активных и пассивных импортных электронных компонентов (более 30 млн. наименований);
- Поставка сложных, дефицитных, либо снятых с производства позиций;
- Оперативные сроки поставки под заказ (от 5 рабочих дней);
- Экспресс доставка в любую точку России;
- Помощь Конструкторского Отдела и консультации квалифицированных инженеров;
- Техническая поддержка проекта, помощь в подборе аналогов, поставка прототипов;
- Поставка электронных компонентов под контролем ВП;
- Система менеджмента качества сертифицирована по Международному стандарту ISO 9001;
- При необходимости вся продукция военного и аэрокосмического назначения проходит испытания и сертификацию в лаборатории (по согласованию с заказчиком);
- Поставка специализированных компонентов военного и аэрокосмического уровня качества (Xilinx, Altera, Analog Devices, Intersil, Interpoint, Microsemi, Actel, Aeroflex, Peregrine, VPT, Syfer, Eurofarad, Texas Instruments, MS Kennedy, Miteq, Cobham, E2V, MA-COM, Hittite, Mini-Circuits, General Dynamics и др.);

Компания «Океан Электроники» является официальным дистрибьютором и эксклюзивным представителем в России одного из крупнейших производителей разъемов военного и аэрокосмического назначения «JONHON», а так же официальным дистрибьютором и эксклюзивным представителем в России производителя высокотехнологичных и надежных решений для передачи СВЧ сигналов «FORSTAR».



JONHON

«JONHON» (основан в 1970 г.)

Разъемы специального, военного и аэрокосмического назначения:

(Применяются в военной, авиационной, аэрокосмической, морской, железнодорожной, горно- и нефтедобывающей отраслях промышленности)

«FORSTAR» (основан в 1998 г.)

ВЧ соединители, коаксиальные кабели, кабельные сборки и микроволновые компоненты:

(Применяются в телекоммуникациях гражданского и специального назначения, в средствах связи, РЛС, а так же военной, авиационной и аэрокосмической отраслях промышленности).



Телефон: 8 (812) 309-75-97 (многоканальный)

Факс: 8 (812) 320-03-32

Электронная почта: ocean@oceanchips.ru

Web: <http://oceanchips.ru/>

Адрес: 198099, г. Санкт-Петербург, ул. Калинина, д. 2, корп. 4, лит. А