

AVX SMD Power Inductors



Version 13.2



www.avx.com

LMax SMD Non-Shield Power Inductor

	LMXN Series – Non-Shielded Style B2-3
	LMXN Series – Non-Shielded Style C4-7
	LMXN Series – Non-Shielded Style D8-11

LMax SMD Shielded Power Inductor

	LMXS Series – Shielded Style B12-15
	LMXS Series – Shielded Style C16-20
	LMXS Series – Shielded Style D21-23
	LMXS Series – Shielded Style F24-27
	LMXS Series – Shielded Style G28-29
	LMXS Series – Shielded Style H30-32
	LMXS Series – Shielded Style J33-34
	LMXS Series – Shielded Style K35-36
	LMXS Series – Shielded Style L37-38
	LMXS Series – Shielded Style M39-40
	LMXS Series – Shielded Style P41-44
	LMXS Series – Shielded Style Q, S45-46

LMax SMD Miniature Power Inductor

	LMMN Series – Miniature Style M47-52
--	--

LMax DIP Power Inductor

	LMDP Series –Non Shielded Style N53-55
	LMDP Series –Shielded Style P56-57
	LMDP Series –Shielded Style S58-60

LMax Low Profile Power Inductor

	LMLP Series –Style C61-66
	LMLP Series –Style D67-73
	LMLP Series –Style M74-75
	LMLP Series –Style O76
	LMLP Series –Style R77-81

NOTICE: Specifications are subject to change without notice. Contact your nearest AVX Sales Office for the latest specifications. All statements, information and data given herein are believed to be accurate and reliable, but are presented without guarantee, warranty, or responsibility of any kind, expressed or implied. Statements or suggestions concerning possible use of our products are made without representation or warranty that any such use is free of patent infringement and are not recommendations to infringe any patent. The user should not assume that all safety measures are indicated or that other measures may not be required. Specifications are typical and may not apply to all applications.

LMax SMD Power Inductor



LMXN Series – Non-Shielded Style B

FEATURES

- Miniature surface mount design
- High power, High saturation inductors
- Very low resistance
- Maximum power density
- Ideal inductors for DC–DC converters
- Available on tape and reel for auto surface mounting

APPLICATIONS

- Notebook Computers
- Handheld Communications
- LCD Televisions
- Power Supply For VTRs
- DC/DC Converters, etc.

CHARACTERISTICS

- Saturation Rated Current: The current when the inductance becomes 30% lower than its initial value. (Ta=25°C)
- Operating temperature range: -40 ~ 85°C

INDUCTANCE AND RATED CURRENT RANGES

- 0705 0.47μH ~ 22.0μH 7.7 ~ 0.70A
- 0906 0.56μH ~ 100μH 7.7 ~ 0.53A
- 1310 0.47μH ~ 100μH 11.4 ~ 0.95A
- 1913 0.47μH ~ 100μH 25.1 ~ 1.80A
- 2216 0.78μH ~ 680μH 30.0 ~ 0.5A
- Electrical specifications at 25°C



DIMENSIONS

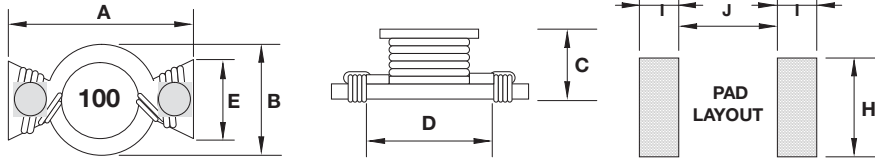

mm (inches)

Type	A max.	B max.	C max.	D	E	H	I	J
0705	7.50 (0.295)	5.20 (0.205)	3.20 (0.126)	4.60 (0.181)	2.50 (0.098)	4.00 (0.157)	2.00 (0.079)	4.00 (0.157)
0906	8.89 (0.350)	6.40 (0.252)	5.00 (0.197)	5.84 (0.230)	2.60 (0.103)	4.06 (0.160)	2.00 (0.079)	5.08 (0.200)
1310	13.20 (0.560)	9.90 (0.390)	6.35 (0.250)	9.50 (0.374)	4.50 (0.177)	6.50 (0.256)	2.30 (0.091)	9.00 (0.344)
1913	19.40 (0.764)	13.30 (0.524)	6.80 (0.268)	12.7 (0.500)	6.60 (0.260)	8.00 (0.315)	3.80 (0.150)	11.7 (0.460)
2216	22.35 (0.880)	16.26 (0.604)	8.00 (0.315)	16.0 (0.630)	8.00 (0.315)	8.64 (0.340)	4.30 (0.169)	14.35 (0.565)

HOW TO ORDER

LM	XN	0705	M	R04	B	T	A	S
Family	Series	Size	Tolerance	Inductance	Style	Termination	Special	Packaging
LM = Power Inductor	XN = Non-Shielded	0705 = 7x5xh (h = see catalog)	M = ±20% P = +40% -20%	R04 = 0.039μH R39 = 0.390μH 3R9 = 3.900μH 390 = 39.00μH 391 = 390.0μH 392 = 3900μH	B = Standard	T = Sn Plate	A = Standard	S = 13" Reel



LMax SMD Power Inductor



LMXN Series – Non-Shielded Style B

ELECTRICAL CHARACTERISTICS

0705/0906/1310/1913/2216

Codes	L (μ H)	Tolerance			Test Condition	DCR (Ω) max.					I sat (A) max*				
		705	0906 2216	1310 1913		0705	0906	1310	1913	2216	0705	0906	1310	1913	2216
R47	0.47	P	-	P	100KHz, 0.1V	0.025	-	0.005	0.003	-	7.7	-	11.4	25.1	-
R56	0.56	-	M	-	100KHz, 0.1V	-	0.010	-	-	-	-	7.7	-	-	-
R78	0.78	-	M	-	100KHz, 0.1V	-	-	-	-	0.003	-	-	-	-	30
1R0	1.0	M	-	P	100KHz, 0.1V	0.050	-	0.006	0.004	-	2.9	-	9.9	15.3	-
1R5	1.5	M	M	P	100KHz, 0.1V	0.050	-	0.008	0.006	0.004	2.6	-	7.9	12	25
2R2	2.2	M	M	M	100KHz, 0.1V	0.070	0.035	0.011	0.008	0.006	2.3	3.5	6.1	10.2	20
3R3	3.3	M	M	M	100KHz, 0.1V	0.080	0.040	0.014	0.009	0.009	2	3	5.1	9.3	17
3R9	3.9	-	M	-	100KHz, 0.1V	-	-	-	-	0.010	-	-	-	-	15
4R7	4.7	M	M	M	100KHz, 0.1V	0.090	0.054	0.018	0.012	0.014	1.5	2.6	4.2	7.7	13
6R0	6.0	-	M	-	100KHz, 0.1V	-	-	-	-	0.017	-	-	-	-	12
6R8	6.8	M	M	M	100KHz, 0.1V	0.130	0.08	0.027	0.019	-	1.2	2.2	3.6	6.2	-
7R8	7.8	-	M	-	100KHz, 0.1V	-	-	-	-	0.018	-	-	-	-	11
100	10	M	M	M	100KHz, 0.1V	0.160	0.111	0.038	0.027	0.026	1.1	1.9	3.3	5.2	10
150	15	M	M	M	100KHz, 0.1V	0.230	0.170	0.045	0.032	0.032	0.9	1.5	2.4	4.3	8
220	22	M	M	M	100KHz, 0.1V	0.370	0.250	0.070	0.050	0.043	0.7	1.2	2	3.7	7
330	33	-	M	M	100KHz, 0.1V	-	0.350	0.100	0.069	0.066	-	0.99	1.7	3	6
470	47	-	M	M	100KHz, 0.1V	-	0.470	0.150	0.109	0.096	-	0.87	1.4	2.4	5
680	68	-	M	M	100KHz, 0.1V	-	0.730	0.220	0.156	0.115	-	0.68	1.2	2	4
101	100	-	M	M	100KHz, 0.1V	-	1.110	0.280	0.206	0.165	-	0.53	0.95	1.8	3
221	220	-	M	-	100KHz, 0.1V	-	-	-	-	0.396	-	-	-	-	2.4
331	330	-	M	-	100KHz, 0.1V	-	-	-	-	0.588	-	-	-	-	1
471	470	-	M	-	100KHz, 0.1V	-	-	-	-	0.950	-	-	-	-	0.8
681	680	-	M	-	100KHz, 0.1V	-	-	-	-	1.200	-	-	-	-	0.5

*Saturation Current: The current when the inductance becomes 30% lower than its initial value. (Ta=25°C)

LMax SMD Power Inductor



LMXN Series – Non-Shielded Style C

FEATURES

- High power, High saturation inductors
- Ideal inductors for DC-DC converters in notebook computers, PDAs, Step-up or step-down converters, flash memory programmers, etc.
- 0705 has ceramic base with gold-plating
- Others have LCP plastic base

APPLICATIONS

- Portable Telephones
- Personal Computers
- DC/DC Converters
- Various Electronic Appliances

CHARACTERISTICS

- Saturation Rated Current: The current when the inductance becomes 10% lower than its initial value. (Ta=25°C)
- Operating temperature range: -40 ~ 125°C

INDUCTANCE AND RATED CURRENT RANGES

- 0705 1.0μH ~ 1000μH 2.9 ~ 0.10A
- 1309 4.7μH ~ 1000μH 4.2 ~ 0.29A
- 13E9 1.0μH ~ 1000μH 9.0 ~ 0.30A
- 13L9 0.47μH ~ 1000μH 40 ~ 0.8A
- 1915 1.0μH ~ 1000μH 20 ~ 1.0A
- Electrical specifications at 25°C



DIMENSIONS

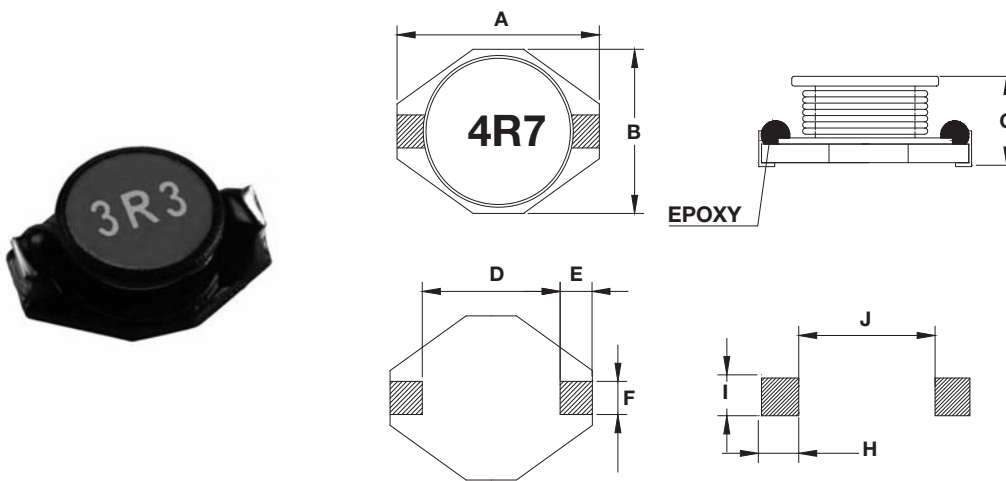

mm (inches)

Type	A max.	B max.	C max.	D	E	F	H	I	J
0705	6.60 (0.260)	4.45 (0.175)	2.92 (0.115)	4.32 (0.170)	1.27 (0.050)	1.02 (0.040)	3.56 (0.140)	1.40 (0.055)	4.06 (0.160)
1309	12.95 (0.510)	9.40 (0.370)	3.00 (0.118)	7.62 (0.300)	2.54 (0.100)	2.54 (0.100)	2.79 (0.110)	2.92 (0.115)	7.37 (0.290)
13E9	12.95 (0.510)	9.40 (0.370)	5.21 (0.205)	7.62 (0.300)	2.54 (0.100)	2.54 (0.100)	2.79 (0.110)	2.92 (0.115)	7.37 (0.290)
13L9	12.95 (0.510)	9.40 (0.370)	11.43 (0.450)	7.62 (0.300)	2.54 (0.100)	2.54 (0.100)	2.79 (0.110)	2.92 (0.115)	7.37 (0.290)
1915	18.54 (0.730)	15.24 (0.600)	7.11 (0.280)	12.7 (0.500)	2.54 (0.100)	2.54 (0.100)	2.79 (0.110)	2.92 (0.115)	12.45 (0.490)

LMax SMD Power Inductor



LMXN Series – Non-Shielded Style C

HOW TO ORDER

LM	XN	1309	M	R04	C	T	A	S
Family	Series	Size	Tolerance	Inductance	Style	Termination	Special	Packaging
LM = Power Inductor	XN = Non-shielded	1309 = 13x9xh 13E9 = 13x9xE(h) (h = see catalog)	M = ±20% N = ±30%	R04 = 0.039µH R39 = 0.390µH 3R9 = 3.900µH 390 = 39.00µH 391 = 390.0µH 392 = 3900µH		T = Sn Plate	A = Standard	S = 13" Reel

ELECTRICAL CHARACTERISTICS

0705

Codes	L (µH)	Tolerance	Test Condition	DCR (Ω) max.	I sat (A) max*
1R0	1.0	M	100KHz, 0.1V	0.05	2.90
1R5	1.5	M	100KHz, 0.1V	0.06	2.60
2R2	2.2	M	100KHz, 0.1V	0.07	2.30
3R3	3.3	M	100KHz, 0.1V	0.08	2.00
4R7	4.7	M	100KHz, 0.1V	0.09	1.50
6R8	6.8	M	100KHz, 0.1V	0.13	1.20
8R2	8.2	M	100KHz, 0.1V	0.16	1.15
100	10	M	100KHz, 0.1V	0.16	1.10
150	15	M	100KHz, 0.1V	0.23	0.90
220	22	M	100KHz, 0.1V	0.37	0.70
330	33	M	100KHz, 0.1V	0.51	0.58
470	47	M	100KHz, 0.1V	0.64	0.50
680	68	M	100KHz, 0.1V	0.86	0.40
101	100	M	100KHz, 0.1V	1.27	0.31
151	150	M	100KHz, 0.1V	2.00	0.27
221	220	M	100KHz, 0.1V	3.11	0.22
331	330	M	100KHz, 0.1V	3.80	0.18
471	470	M	100KHz, 0.1V	5.06	0.16
681	680	M	100KHz, 0.1V	9.20	0.14
102	1000	M	100KHz, 0.1V	13.8	0.10

1309

Codes	L (µH)	Tolerance	Test Condition	DCR (Ω) max.	I sat (A) max*
4R7	4.7	M	100KHz, 0.1V	0.036	4.20
6R8	6.8	M	100KHz, 0.1V	0.060	3.90
100	10	M	100KHz, 0.1V	0.085	2.70
150	15	M	100KHz, 0.1V	0.12	2.30
220	22	M	100KHz, 0.1V	0.18	1.80
330	33	M	100KHz, 0.1V	0.25	1.60
470	47	M	100KHz, 0.1V	0.32	1.30
680	68	M	100KHz, 0.1V	0.54	1.10
101	100	M	100KHz, 0.1V	0.69	0.87
151	150	M	100KHz, 0.1V	0.94	0.74
221	220	M	100KHz, 0.1V	1.60	0.56
331	330	M	100KHz, 0.1V	2.15	0.50
471	470	M	100KHz, 0.1V	3.30	0.40
681	680	M	100KHz, 0.1V	4.40	0.33
102	1000	M	100KHz, 0.1V	7.00	0.29

*Saturation Current: The current when the inductance becomes 10% lower than its initial value. (Ta=25°C)

LMax SMD Power Inductor



LMXN Series – Non-Shielded Style C

13E9

Codes	L (μH)	Tolerance	Test Condition	DCR (Ω) max.	I sat (A) max*
1R0	1.0	M	100KHz, 0.1V	0.009	9.00
1R5	1.5	M	100KHz, 0.1V	0.010	8.00
2R2	2.2	M	100KHz, 0.1V	0.012	7.00
3R3	3.3	M	100KHz, 0.1V	0.015	6.40
4R7	4.7	M	100KHz, 0.1V	0.018	5.40
6R8	6.8	M	100KHz, 0.1V	0.027	4.60
100	10	M	100KHz, 0.1V	0.038	3.80
150	15	M	100KHz, 0.1V	0.046	3.00
220	22	M	100KHz, 0.1V	0.085	2.60
330	33	M	100KHz, 0.1V	0.100	2.00
470	47	M	100KHz, 0.1V	0.140	1.60
680	68	M	100KHz, 0.1V	0.200	1.40
101	100	M	100KHz, 0.1V	0.280	1.20
151	150	M	100KHz, 0.1V	0.400	1.00
221	220	M	100KHz, 0.1V	0.610	0.80
331	330	M	100KHz, 0.1V	1.020	0.60
471	470	M	100KHz, 0.1V	1.270	0.50
681	680	M	100KHz, 0.1V	2.020	0.40
102	1000	M	100KHz, 0.1V	3.000	0.30

13L9

Codes	L (μH)	Tolerance	Test Condition	DCR (Ω) max.	I sat (A) max*
R47	0.47	N	100KHz, 0.1V	0.008	40.0
R82	0.82	N	100KHz, 0.1V	0.009	34.7
1R2	1.2	N	100KHz, 0.1V	0.010	28.4
1R5	1.5	N	100KHz, 0.1V	0.010	25.7
2R2	2.2	N	100KHz, 0.1V	0.012	23.0
3R5	3.5	N	100KHz, 0.1V	0.015	21.0
4R7	4.7	N	100KHz, 0.1V	0.020	18.0
5R6	5.6	N	100KHz, 0.1V	0.022	16.0
6R8	6.8	N	100KHz, 0.1V	0.030	15.0
8R2	8.2	N	100KHz, 0.1V	0.033	10.0
100	10	M	100KHz, 0.1V	0.040	8.00
150	15	M	100KHz, 0.1V	0.050	7.00
220	22	M	100KHz, 0.1V	0.066	5.50
330	33	M	100KHz, 0.1V	0.080	4.00
470	47	M	100KHz, 0.1V	0.11	3.80
680	68	M	100KHz, 0.1V	0.17	3.00
101	100	M	100KHz, 0.1V	0.22	2.50
151	150	M	100KHz, 0.1V	0.34	2.00
221	220	M	100KHz, 0.1V	0.44	1.60
331	330	M	100KHz, 0.1V	0.70	1.20
471	470	M	100KHz, 0.1V	0.95	1.00
681	680	M	100KHz, 0.1V	1.20	1.00
102	1000	M	100KHz, 0.1V	2.00	0.80

*Saturation Current: The current when the inductance becomes 10% lower than its initial value. (Ta=25°C)

LMax SMD Power Inductor



Non-Shielded Style C

1915

Codes	L (μH)	Tolerance	Test Condition	DCR (Ω) max.	I sat (A) max*
1R0	1.0	M	100KHz, 0.1V	0.009	20
2R2	2.2	M	100KHz, 0.1V	0.014	16
3R3	3.3	M	100KHz, 0.1V	0.018	14
5R6	5.6	M	100KHz, 0.1V	0.020	12
100	10	M	100KHz, 0.1V	0.031	10
150	15	M	100KHz, 0.1V	0.036	8.0
220	22	M	100KHz, 0.1V	0.047	7.0
330	33	M	100KHz, 0.1V	0.066	5.5
470	47	M	100KHz, 0.1V	0.095	4.5
680	68	M	100KHz, 0.1V	0.130	3.5
101	100	M	100KHz, 0.1V	0.190	3.0
151	150	M	100KHz, 0.1V	0.250	2.6
221	220	M	100KHz, 0.1V	0.380	2.4
331	330	M	100KHz, 0.1V	0.560	1.9
471	470	M	100KHz, 0.1V	0.850	1.4
681	680	M	100KHz, 0.1V	1.100	1.2
102	1000	M	100KHz, 0.1V	1.800	1.0

*Saturation Current: The current when the inductance becomes 10% lower than its initial value. (Ta=25°C)

LMax SMD Power Inductor



LMXN Series – Non-Shielded Style D

FEATURES

- Open Magnetic Circuit Construction
- Small Surface Area

APPLICATIONS

- LCD Televisions
- Notebooks
- Portable Communication
- DC/DC Converters, etc.

CHARACTERISTICS

- Rated Current (IDC): The DC current that will cause an approximate ΔT of 40°C. ($T_a=25^\circ\text{C}$)
- Operating temperature range: $-40^\circ\text{C} \sim +125^\circ\text{C}$

INDUCTANCE AND RATED CURRENT RANGES

- 0504 1.0 μH ~ 33 μH 3.30 ~ 0.56A
- 0605 10.0 μH ~ 220 μH 1.44 ~ 0.35A
- 0808 10.0 μH ~ 330 μH 1.44 ~ 0.28A
- 08G8 10.0 μH ~ 470 μH 2.30 ~ 0.34A
- 1009 10.0 μH ~ 560 μH 2.38 ~ 0.32A
- 10F9 10.0 μH ~ 820 μH 2.6 ~ 0.24A
- Electrical specifications at 25°C



DIMENSIONS

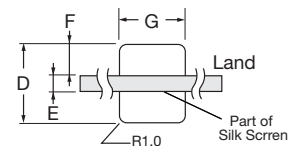
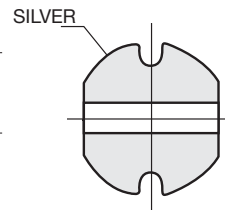
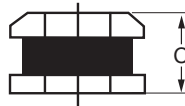
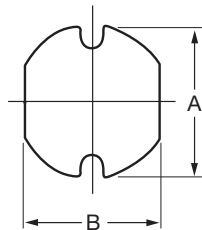

mm (inches)

Type	A	B	C	D	E	F	G
0504	4.50 ± 0.30 (0.177 ± .012)	4.00 ± 0.30 (0.158 ± 0.012)	3.20 ± 0.30 (0.126 ± 0.012)	5.00 (0.197)	1.50 (0.059)	1.75 (0.069)	4.50 (0.177)
0605	5.80 ± 0.30 (0.228 ± .012)	5.20 ± 0.30 (0.205 ± 0.012)	4.50 ± 0.35 (0.177 ± 0.014)	6.00 (0.236)	1.70 (0.067)	2.15 (0.085)	5.50 (0.217)
0808	7.80 ± 0.30 (0.307 ± .012)	7.30 ± 0.30 (0.276 ± 0.012)	3.50 ± 0.50 (0.140 ± 0.020)	8.00 (0.315)	2.00 (0.079)	3.00 (0.118)	7.50 (0.295)
08G8	7.80 ± 0.30 (0.307 ± .012)	7.30 ± 0.30 (0.287 ± 0.012)	5.08 ± 0.50 (0.200 ± 0.020)	8.00 (0.315)	2.00 (0.079)	3.00 (0.118)	7.50 (0.295)
1009	10.0 ± 0.30 (0.394 ± .012)	9.00 ± 0.30 (0.354 ± 0.012)	4.00 ± 0.50 (0.158 ± 0.020)	10.0 (0.394)	2.50 (0.098)	3.75 (0.148)	9.50 (0.374)
10F9	10.0 ± 0.40 (0.394 ± .016)	9.00 ± 0.40 (0.354 ± 0.016)	5.40 ± 0.40 (0.213 ± 0.016)	10.0 (0.394)	2.50 (0.098)	3.75 (0.148)	9.50 (0.374)

HOW TO ORDER

LM

Family

LM = Power Inductor

XN

Series

XN = Non-shielded

1009

Size

1009 = 10x9xh
10F9 = 10x9xF(h)
(h = see catalog)

M

Tolerance

M = ±20%

R04

Inductance

1R0 = 1.00 μH
390 = 39.00 μH
391 = 390.0 μH

D

Style

T

Termination

T = Sn Plate

A

Special

A = Standard

S

Packaging

S = 13" Reel

LMax SMD Power Inductor



LMXN Series – Non-Shielded Style D

ELECTRICAL CHARACTERISTICS

0504

Codes	L (μ H)	Tolerance	Test Condition	DCR (Ω) max.	IDC (A) max.
1R0	1.0	M	100KHz, 1.0V	0.048	3.30
1R4	1.4	M	100KHz, 1.0V	0.056	2.80
1R8	1.8	M	100KHz, 1.0V	0.063	2.45
2R2	2.2	M	100KHz, 1.0V	0.071	2.21
2R7	2.7	M	100KHz, 1.0V	0.078	2.00
3R3	3.3	M	100KHz, 1.0V	0.086	1.81
3R9	3.9	M	100KHz, 1.0V	0.093	1.66
4R7	4.7	M	100KHz, 1.0V	0.108	1.51
5R6	5.6	M	100KHz, 1.0V	0.125	1.40
6R8	6.8	M	100KHz, 1.0V	0.131	1.26
8R2	8.2	M	100KHz, 1.0V	0.146	1.14
100	10	M	100KHz, 1.0V	0.182	1.04
120	12	M	100KHz, 1.0V	0.210	0.97
150	15	M	100KHz, 1.0V	0.235	0.85
180	18	M	100KHz, 1.0V	0.338	0.74
220	22	M	100KHz, 1.0V	0.378	0.68
270	27	M	100KHz, 1.0V	0.522	0.62
330	33	M	100KHz, 1.0V	0.540	0.56

0605

Codes	L (μ H)	Tolerance	Test Condition	DCR (Ω) max.	IDC (A) max.
100	10	M	100KHz, 1.0V	0.100	1.44
120	12	M	100KHz, 1.0V	0.120	1.40
150	15	M	100KHz, 1.0V	0.140	1.30
180	18	M	100KHz, 1.0V	0.150	1.23
220	22	M	100KHz, 1.0V	0.180	1.11
270	27	M	100KHz, 1.0V	0.200	0.97
330	33	M	100KHz, 1.0V	0.230	0.88
390	39	M	100KHz, 1.0V	0.320	0.80
470	47	M	100KHz, 1.0V	0.370	0.72
560	56	M	100KHz, 1.0V	0.420	0.68
680	68	M	100KHz, 1.0V	0.460	0.61
820	82	M	100KHz, 1.0V	0.600	0.58
101	100	M	100KHz, 1.0V	0.700	0.52
121	120	M	100KHz, 1.0V	0.930	0.48
151	150	M	100KHz, 1.0V	1.100	0.40
181	180	M	100KHz, 1.0V	1.380	0.38
221	220	M	100KHz, 1.0V	1.570	0.35

LMax SMD Power Inductor



LMXN Series – Non-Shielded Style D

0808

Codes	L (µH)	Tolerance	Test Condition	DCR (Ω) max.	IDC (A) max.
100	10	M	100KHz, 1.0V	1.44	0.081
120	12	M	100KHz, 1.0V	1.39	0.089
150	15	M	100KHz, 1.0V	1.24	0.104
180	18	M	100KHz, 1.0V	1.12	0.111
220	22	M	100KHz, 1.0V	1.07	0.129
270	27	M	100KHz, 1.0V	0.94	0.153
330	33	M	100KHz, 1.0V	0.85	0.170
390	39	M	100KHz, 1.0V	0.74	0.217
470	47	M	100KHz, 1.0V	0.68	0.252
560	56	M	100KHz, 1.0V	0.64	0.282
680	68	M	100KHz, 1.0V	0.59	0.332
820	82	M	100KHz, 1.0V	0.54	0.406
101	100	M	100KHz, 1.0V	0.51	0.481
121	120	M	100KHz, 1.0V	0.49	0.536
151	150	M	100KHz, 1.0V	0.40	0.755
181	180	M	100KHz, 1.0V	0.36	1.022
221	220	M	100KHz, 1.0V	0.31	1.200
271	270	M	100KHz, 1.0V	0.29	1.306
331	330	M	100KHz, 1.0V	0.28	1.495

08G8

Codes	L (µH)	Tolerance	Test Condition	DCR (Ω) max.	IDC (A) max.
100	10	M	100KHz, 1.0V	0.070	2.30
120	12	M	100KHz, 1.0V	0.080	2.00
150	15	M	100KHz, 1.0V	0.090	1.80
180	18	M	100KHz, 1.0V	0.100	1.60
220	22	M	100KHz, 1.0V	0.110	1.50
270	27	M	100KHz, 1.0V	0.120	1.30
330	33	M	100KHz, 1.0V	0.130	1.20
470	47	M	100KHz, 1.0V	0.180	1.00
560	56	M	100KHz, 1.0V	0.240	0.94
680	68	M	100KHz, 1.0V	0.280	0.85
820	82	M	100KHz, 1.0V	0.370	0.78
101	100	M	100KHz, 1.0V	0.430	0.72
121	120	M	100KHz, 1.0V	0.470	0.66
151	150	M	100KHz, 1.0V	0.640	0.58
221	220	M	100KHz, 1.0V	0.960	0.49
331	330	M	100KHz, 1.0V	1.260	0.40
391	390	M	100KHz, 1.0V	1.770	0.36
471	470	M	100KHz, 1.0V	1.960	0.34

LMax SMD Power Inductor



LMXN Series – Non-Shielded Style D

1009

Codes	L (µH)	Tolerance	Test Condition	DCR (Ω) max.	IDC (A) max.
100	10	M	100KHz, 1.0V	0.053	2.38
120	12	M	100KHz, 1.0V	0.061	2.13
150	15	M	100KHz, 1.0V	0.070	1.87
180	18	M	100KHz, 1.0V	0.081	1.73
220	22	M	100KHz, 1.0V	0.088	1.60
330	33	M	100KHz, 1.0V	0.120	1.26
470	47	M	100KHz, 1.0V	0.170	1.10
560	56	M	100KHz, 1.0V	0.199	1.01
680	68	M	100KHz, 1.0V	0.223	0.91
820	82	M	100KHz, 1.0V	0.252	0.85
101	100	M	100KHz, 1.0V	0.344	0.74
121	120	M	100KHz, 1.0V	0.396	0.69
181	180	M	100KHz, 1.0V	0.621	0.56
221	220	M	100KHz, 1.0V	0.721	0.53
331	330	M	100KHz, 1.0V	1.100	0.42
471	470	M	100KHz, 1.0V	1.526	0.35
561	560	M	100KHz, 1.0V	1.904	0.32

10F9

Codes	L (µH)	Tolerance	Test Condition	DCR (Ω) max.	IDC (A) max.
100	10	M	100KHz, 1.0V	0.060	2.60
120	12	M	100KHz, 1.0V	0.070	2.45
150	15	M	100KHz, 1.0V	0.080	2.27
220	22	M	100KHz, 1.0V	0.100	1.95
330	33	M	100KHz, 1.0V	0.120	1.50
390	39	M	100KHz, 1.0V	0.140	1.37
470	47	M	100KHz, 1.0V	0.170	1.28
560	56	M	100KHz, 1.0V	0.190	1.17
680	68	M	100KHz, 1.0V	0.220	1.11
820	82	M	100KHz, 1.0V	0.250	1.00
101	100	M	100KHz, 1.0V	0.350	0.97
121	120	M	100KHz, 1.0V	0.400	0.89
151	150	M	100KHz, 1.0V	0.470	0.78
221	220	M	100KHz, 1.0V	0.730	0.66
271	270	M	100KHz, 1.0V	0.970	0.57
331	330	M	100KHz, 1.0V	1.150	0.52
471	470	M	100KHz, 1.0V	1.480	0.42
561	560	M	100KHz, 1.0V	1.900	0.33
821	820	M	100KHz, 1.0V	2.550	0.24

LMax SMD Power Inductor



LMXS Series – Shielded Style B

FEATURES

- Directly connected electrode on ferrite core
- Excellent property with high saturation for surface mounting

APPLICATIONS

- OA Equipment
- Notebook PCs
- LCD Monitor
- Portable Terminal Equipment
- DC/DC Converters, etc.
- Power Supply for VTR

CHARACTERISTICS

- Rated DC Current: The current when the inductance becomes 30% lower than its initial value.
- Operating temperature: -40 ~ 85°C

INDUCTANCE AND RATED CURRENT RANGES

- 04B4 0.47 ~ 2200μH 1.84 ~ 0.035A
- 04C4 1.0 ~ 6800μH 1.90 ~ 0.017A
- 04A4 1.0 ~ 100μH 1.50 ~ 0.100A
- 0505 0.47 ~ 820μH 2.33 ~ 0.030A
- 05C5 0.47 ~ 2500μH 4.82 ~ 0.045A
- 0606 1.0 ~ 3300μH 4.70 ~ 0.026A
- Electrical specifications at 25°C



DIMENSIONS

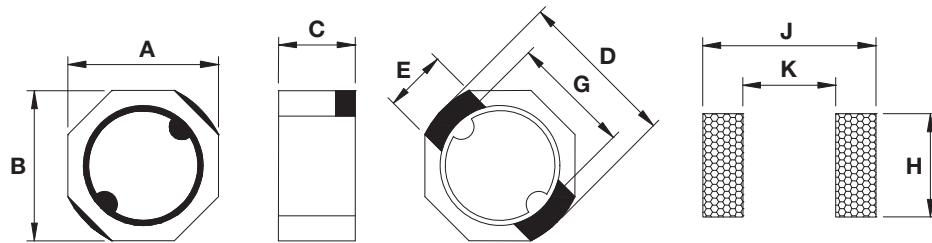

mm (inches)

Type	A	B	C max.	D	E	G	H	K	J
04B4	3.85 ± 0.30 (0.152 ± 0.012)	3.85 ± 0.30 (0.152 ± 0.012)	2.00 (0.079)	3.9 ± 0.20 (0.154 ± 0.008)	1.60 (0.063)	3.20 (0.126)	1.90 (0.075)	3.00 (0.118)	4.55 (0.179)
04C4	3.85 ± 0.30 (0.152 ± 0.012)	3.85 ± 0.30 (0.152 ± 0.012)	3.00 (0.118)	3.9 ± 0.20 (0.154 ± 0.008)	1.60 (0.063)	3.20 (0.126)	1.90 (0.075)	3.00 (0.118)	4.55 (0.179)
04A4	3.85 ± 0.30 (0.152 ± 0.012)	3.85 ± 0.30 (0.152 ± 0.012)	1.50 (0.059)	4.80 max. (0.189 max.)	1.60 (0.063)	3.00 (0.118)	2.00 (0.079)	2.60 (0.102)	5.20 (0.205)
0505	5.30 max. (0.207 max.)	5.30 max. (0.207 max.)	2.00 (0.079)	5.7 ± 0.40 (0.224 ± 0.016)	1.60 (0.063)	4.20 (0.165)	1.90 (0.075)	3.90 (0.154)	5.70 (0.224)
05C5	5.30 max. (0.207 max.)	5.30 max. (0.207 max.)	3.00 (0.118)	5.7 ± 0.40 (0.224 ± 0.016)	1.60 (0.063)	4.20 (0.165)	1.90 (0.075)	3.90 (0.154)	5.70 (0.224)
0606	5.90 ± 0.20 (0.232 ± 0.008)	5.90 ± 0.20 (0.232 ± 0.008)	3.00 (0.118)	6.4 ± 0.30 (0.252 ± 0.012)	2.40 (0.094)	4.70 (0.185)	2.70 (0.106)	4.40 (0.173)	6.50 (0.256)

HOW TO ORDER

LM	XS	0505	M	R04	B	T	A	S
Family	Series	Size	Tolerance	Inductance	Style	Termination	Special	Packaging
LM = Power Inductor	XS = Shielded	0505 = 5x5xh 05A5 = 5x5xA(h) (h = see catalog)	M = ±20% N = ±30% P = ±40%	R04 = 0.039μH R39 = 0.390μH 3R9 = 3.900μH 390 = 39.00μH 391 = 390.0μH 392 = 3900μH	T = Sn Plate	A = Standard	S = 13" Reel	



LMax SMD Power Inductor



LMXS Series – Shielded Style B

ELECTRICAL CHARACTERISTICS

0404/04B4/04C4

Codes	L (μ H)	Tolerance	Test Condition	DCR (Ω) max.		I sat (A) max*	
				04B4	04C4	04B4	04C4
R47	0.47	N	100 KHz, 0.25V	0.017	–	1.84	–
1R0	1.0	N	100 KHz, 0.25V	0.030	0.009	1.80	1.90
1R2	1.2	N	100 KHz, 0.25V	0.043	0.010	1.70	1.75
1R5	1.5	N	100 KHz, 0.25V	0.052	0.013	1.60	1.45
1R8	1.8	N	100 KHz, 0.25V	0.056	–	1.55	–
2R0	2.0	N	100 KHz, 0.25V	0.057	0.016	1.51	1.25
2R2	2.2	N	100 KHz, 0.25V	0.058	0.025	1.50	1.15
2R4	2.4	N	100 KHz, 0.25V	0.059	–	1.41	–
2R5	2.5	N	100 KHz, 0.25V	0.059	0.018	1.40	1.05
2R7	2.7	N	100 KHz, 0.25V	0.060	0.020	1.35	1.00
3R3	3.3	N	100 KHz, 0.25V	0.064	0.030	1.30	0.96
3R5	3.5	N	100 KHz, 0.25V	0.127	0.025	1.30	0.95
3R9	3.9	N	100 KHz, 0.25V	–	0.033	–	0.87
4R7	4.7	N	100 KHz, 0.25V	0.146	0.039	1.10	0.78
5R6	5.6	N	100 KHz, 0.25V	0.176	0.044	0.95	0.74
6R2	6.2	N	100 KHz, 0.25V	0.220	–	0.91	–
6R8	6.8	N	100 KHz, 0.25V	0.238	0.051	0.90	0.68
8R2	8.2	N	100 KHz, 0.25V	0.272	0.065	0.80	0.57
100	10	M	1KHz, 0.25V	0.299	0.092	0.70	0.43
120	12	M	1KHz, 0.25V	–	0.100	–	0.38
150	15	M	1KHz, 0.25V	0.472	0.113	0.61	0.33
180	18	M	1KHz, 0.25V	0.552	0.125	0.58	0.30
220	22	M	1KHz, 0.25V	0.592	0.146	0.52	0.28
270	27	M	1KHz, 0.25V	0.630	0.176	0.44	0.26
330	33	M	1KHz, 0.25V	1.075	0.214	0.43	0.23
390	39	M	1KHz, 0.25V	1.269	0.225	0.37	0.21
470	47	M	1KHz, 0.25V	1.309	0.304	0.34	0.19
500	50	M	1KHz, 0.25V	–	–	–	–
560	56	M	1KHz, 0.25V	1.960	0.324	0.29	0.170
680	68	M	1KHz, 0.25V	2.613	0.472	0.25	0.156
820	82	M	1KHz, 0.25V	2.950	0.539	0.20	0.142
101	100	M	1KHz, 0.25V	3.255	0.608	0.19	0.128
121	120	M	1KHz, 0.25V	3.350	0.757	0.15	0.116
151	150	M	1KHz, 0.25V	3.550	0.882	0.12	0.106
181	180	M	1KHz, 0.25V	4.000	1.130	0.10	0.095
221	220	M	1KHz, 0.25V	4.900	1.269	0.09	0.087
271	270	M	1KHz, 0.25V	–	1.570	–	0.080
331	330	M	1KHz, 0.25V	7.280	1.930	0.08	0.078
391	390	M	1KHz, 0.25V	–	2.360	–	0.073
471	470	M	1KHz, 0.25V	–	2.770	–	0.068
561	560	M	1KHz, 0.25V	–	3.520	–	0.065
681	680	M	1KHz, 0.25V	13.37	4.250	0.07	0.056
821	820	M	1KHz, 0.25V	–	4.830	–	0.050
102	1000	M	1KHz, 0.25V	19.55	6.260	0.065	0.047
122	1200	M	1KHz, 0.25V	–	7.860	–	0.043
152	1522	M	1KHz, 0.25V	36.15	9.980	0.038	0.039

*Saturation Current: The current when the inductance becomes 30% lower than its initial value.

LMax SMD Power Inductor



LMXS Series – Shielded Style B

04A4

Codes	L (μH)	Tolerance	Test Condition	DCR (Ω) max.	I sat (A) max*
1R0	1.0	N	100KHz, 0.1V	0.058	1.50
1R2	1.2	N	100KHz, 0.1V	0.070	1.40
2R2	2.2	N	100KHz, 0.1V	0.082	1.00
3R3	3.3	N	100KHz, 0.1V	0.105	0.92
3R9	3.9	N	100KHz, 0.1V	0.120	0.80
4R7	4.7	N	100KHz, 0.1V	0.150	0.76
5R6	5.6	N	100KHz, 0.1V	0.180	0.69
6R8	6.8	N	100KHz, 0.1V	0.220	0.62
8R2	8.2	N	100KHz, 0.1V	0.240	0.56
100	10	N	100KHz, 0.1V	0.255	0.50
150	15	N	100KHz, 0.1V	0.390	0.40
220	22	M	100KHz, 0.1V	0.610	0.32
330	33	M	100KHz, 0.1V	0.920	0.28
470	47	M	100KHz, 0.1V	1.130	0.20
680	68	M	100KHz, 0.1V	1.520	0.15
101	100	M	100KHz, 0.1V	2.120	0.10

*Saturation Current: The current when the inductance becomes 30% lower than its initial value.

LMax SMD Power Inductor



LMXS Series – Shielded Style B

0505/05C5/0606

Codes	L (μ H)	Tolerance	Test Condition	DCR (Ω) max.			I sat (A) max*		
				0505	05C5	0606	0505	05C5	0606
R47	0.47	N	100KHz, 0.25V	0.015	0.010	–	2.33	4.82	–
1R0	1.0	N	100KHz, 0.25V	0.024	0.015	0.014	2.27	4.00	4.70
1R1	1.1	N	100KHz, 0.25V	–	0.020	–	–	3.87	–
1R2	1.2	N	100KHz, 0.25V	0.044	0.022	0.016	2.15	3.80	3.90
1R5	1.5	N	100KHz, 0.25V	–	–	0.018	–	–	3.52
1R8	1.8	N	100KHz, 0.25V	–	–	0.019	–	–	3.25
2R0	2.0	N	100KHz, 0.25V	0.046	0.027	0.022	1.90	2.92	2.95
2R2	2.2	N	100KHz, 0.25V	0.059	0.029	0.022	1.63	2.41	2.95
2R4	2.4	N	100KHz, 0.25V	0.062	0.034	0.024	1.50	2.36	2.75
2R7	2.7	N	100KHz, 0.25V	–	–	0.027	–	–	2.55
3R3	3.3	N	100KHz, 0.25V	0.073	0.040	0.030	1.34	1.95	2.45
3R9	3.9	N	100KHz, 0.25V	0.081	–	0.034	1.20	–	2.35
4R1	4.1	N	100KHz, 0.25V	0.087	0.045	–	1.14	1.87	–
4R7	4.7	N	100KHz, 0.25V	–	0.052	0.042	–	1.60	2.25
5R6	5.6	N	100KHz, 0.25V	–	–	0.048	–	–	2.05
6R8	6.8	N	100KHz, 0.25V	0.105	0.068	0.054	0.95	1.51	1.85
8R2	8.2	N	100KHz, 0.25V	0.139	0.084	0.058	0.90	1.38	1.65
100	10	M	1KHz, 0.25V	0.150	0.090	0.065	0.76	1.33	1.45
120	12	M	1KHz, 0.25V	–	0.120	0.082	–	1.06	1.35
150	15	M	1KHz, 0.25V	0.210	0.142	0.096	0.63	1.05	1.25
180	18	M	1KHz, 0.25V	–	0.192	0.110	–	0.90	1.15
220	22	M	1KHz, 0.25V	0.275	0.208	0.140	0.56	0.86	0.98
270	27	M	1KHz, 0.25V	0.452	0.222	0.170	0.48	0.75	0.90
330	33	M	1KHz, 0.25V	0.455	0.257	0.210	0.44	0.72	0.80
390	39	M	1KHz, 0.25V	–	0.320	0.240	–	0.64	0.72
470	47	M	1KHz, 0.25V	0.730	0.352	0.280	0.35	0.62	0.70
560	56	M	1KHz, 0.25V	–	0.459	0.340	–	0.53	0.66
680	68	M	1KHz, 0.25V	0.935	0.525	0.410	0.30	0.51	0.58
820	82	M	1KHz, 0.25V	1.300	0.770	0.490	0.27	0.48	0.52
101	100	M	1KHz, 0.25V	1.500	0.801	0.550	0.23	0.43	0.46
121	120	M	1KHz, 0.25V	1.910	0.850	0.700	0.22	0.34	0.42
151	150	M	1KHz, 0.25V	2.680	1.100	0.780	0.21	0.26	0.36
181	180	M	1KHz, 0.25V	3.040	1.190	0.960	0.20	0.24	0.34
221	220	M	1KHz, 0.25V	3.520	1.530	1.080	0.195	0.20	0.32
271	270	M	1KHz, 0.25V	4.380	–	1.360	0.193	–	0.28
331	330	M	1KHz, 0.25V	5.560	2.030	1.820	0.190	0.19	0.24
391	390	M	1KHz, 0.25V	–	3.000	2.050	–	0.16	0.22
471	470	M	1KHz, 0.25V	7.820	3.500	2.580	0.180	0.15	0.20
561	560	M	1KHz, 0.25V	–	4.080	3.160	–	0.14	0.18
681	680	M	1KHz, 0.25V	–	–	4.040	–	–	0.16
821	820	M	1KHz, 0.25V	15.00	–	4.900	0.120	–	0.14
102	1000	M	1KHz, 0.25V	–	–	6.000	–	–	0.13
122	1200	M	1KHz, 0.25V	–	8.500	7.600	–	0.070	0.12
152	1522	M	1KHz, 0.25V	–	10.00	9.440	–	0.065	0.10
182	1800	M	1KHz, 0.25V	–	13.15	11.70	–	0.062	0.098
222	2200	M	1KHz, 0.25V	–	19.00	13.40	–	0.050	0.095
252	2500	M	1KHz, 0.25V	–	20.00	–	–	0.045	–
272	2700	M	1KHz, 0.25V	–	–	17.30	–	–	0.086
332	3300	M	1KHz, 0.25V	–	–	22.10	–	–	0.078

*Saturation Current: The current when the inductance becomes 30% lower than its initial value.

LMax SMD Power Inductor



LMXS Series – Shielded Style C

FEATURES

- Directly connected electrode on ferrite core
- Available in magnetically shielded
- Low DC resistance
- Suitable for large current
- Available on tape and reel for auto surface mounting

APPLICATIONS

- Power Supply For VTRs
- OA Equipment.
- Notebook PCs
- Portable Communication Equipment
- DC/DC Converters, etc.

CHARACTERISTICS

- Rated Current:
0404/40B4/0505/50B5/05C5/0707/07B7/07D7: The DC current when the inductance becomes 30% lower than its initial value.
04C4/1010/10101D/101H: The DC current when the inductance becomes 35% lower than its initial value. (Ta=25°C)
- Operating temperature range: -40 ~ +105°C

INDUCTANCE AND RATED CURRENT RANGES

- | | | |
|--------|---------------|---------------|
| • 0404 | 1.0 ~ 180μH | 1.60 ~ 0.110A |
| • 04B4 | 0.47 ~ 1800μH | 1.84 ~ 0.036A |
| • 04C4 | 1.5 ~ 560μH | 1.90 ~ 0.090A |
| • 0505 | 1.2 ~ 1000μH | 1.77 ~ 0.067A |
| • 05B5 | 1.0 ~ 820μH | 2.70 ~ 0.026A |
| • 05C5 | 1.0 ~ 2500μH | 4.00 ~ 0.045A |
| • 0707 | 1.0 ~ 820μH | 3.28 ~ 0.100A |
| • 07B7 | 1.0 ~ 1500μH | 3.52 ~ 0.095A |
| • 07D7 | 0.36 ~ 1000μH | 9.24 ~ 0.180A |
| • 101B | 1.0 ~ 2200μH | 4.10 ~ 0.100A |
| • 101D | 0.56 ~ 1000μH | 12.6 ~ 0.280A |
| • 101H | 0.56 ~ 39μH | 10.18 ~ 1.30A |
- Electrical specifications at 25°C



DIMENSIONS

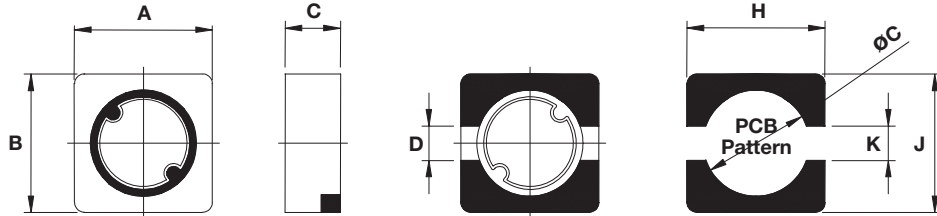

mm (inches)

Type	A	B	C max.	D	H	J	K	øC
0404	3.80 ± 0.30 (0.150 ± 0.012)	3.80 ± 0.30 (0.150 ± 0.012)	1.25 (0.049)	1.20 (0.047)	4.40 (0.173)	4.40 (0.173)	1.10 (0.043)	3.00 (0.118)
04B4	3.80 ± 0.30 (0.150 ± 0.012)	3.80 ± 0.30 (0.150 ± 0.012)	2.00 (0.079)	1.20 (0.047)	4.40 (0.173)	4.40 (0.173)	1.10 (0.043)	3.00 (0.118)
04C4	3.80 ± 0.30 (0.150 ± 0.012)	3.80 ± 0.30 (0.150 ± 0.012)	3.00 (0.118)	1.20 (0.047)	4.40 (0.173)	4.40 (0.173)	1.10 (0.043)	3.00 (0.118)
0505	5.00 ± 0.30 (0.197 ± 0.012)	5.00 ± 0.30 (0.197 ± 0.012)	1.20 (0.047)	2.00 (0.079)	5.90 (0.232)	5.90 (0.232)	1.90 (0.075)	4.20 (0.165)
05B5	5.00 ± 0.30 (0.197 ± 0.012)	5.00 ± 0.30 (0.197 ± 0.012)	2.00 (0.079)	2.00 (0.079)	5.90 (0.232)	5.90 (0.232)	1.90 (0.075)	4.20 (0.165)
05C5	5.00 ± 0.30 (0.197 ± 0.012)	5.00 ± 0.30 (0.197 ± 0.012)	3.00 (0.118)	2.00 (0.079)	5.90 (0.232)	5.90 (0.232)	1.90 (0.075)	4.20 (0.165)
0707	6.90 ± 0.30 (0.272 ± 0.012)	6.90 ± 0.30 (0.272 ± 0.012)	1.50 (0.059)	2.50 (0.098)	7.30 (0.287)	7.30 (0.287)	2.00 (0.079)	5.30 (0.209)
07B7	6.90 ± 0.30 (0.272 ± 0.012)	6.90 ± 0.30 (0.272 ± 0.012)	1.90 (0.075)	2.50 (0.098)	7.30 (0.287)	7.30 (0.287)	2.00 (0.079)	5.30 (0.209)
07D7	7.00 ± 0.40 (0.276 ± 0.016)	7.00 ± 0.40 (0.276 ± 0.016)	4.30 (0.169)	1.80 (0.071)	8.00 (0.315)	8.00 (0.315)	1.60 (0.063)	6.00 (0.236)
101B	10.0 ± 0.30 (0.394 ± 0.012)	10.0 ± 0.30 (0.394 ± 0.012)	1.50 (0.059)	2.50 (0.098)	10.6 (0.315)	10.6 (0.315)	2.30 (0.091)	8.00 (0.315)
101D	10.0 ± 0.30 (0.394 ± 0.012)	10.0 ± 0.30 (0.394 ± 0.012)	4.00 (0.157)	2.50 (0.098)	10.6 (0.315)	10.6 (0.315)	2.30 (0.091)	8.00 (0.315)
101H	10.0 ± 0.30 (0.394 ± 0.012)	10.0 ± 0.30 (0.394 ± 0.012)	6.70 (0.264)	2.50 (0.098)	10.6 (0.315)	10.6 (0.315)	2.30 (0.091)	8.00 (0.315)



LMax SMD Power Inductor



LMXS Series – Shielded Style C

HOW TO ORDER

LM	XS	0707	M	R04	C	T	A	S
↓	↓	↓	↓	↓	↓	↓	↓	↓
Family	Series	Size	Tolerance	Inductance	Style	Termination	Special	Packaging
LM = Power Inductor	XS = Shielded	0707 = 7x7xh 07D7 = 7x7xD(h) 101B = 10x10xB(h) (h = see catalog)	M = ±20% N = ±30%	R04 = 0.039µH R39 = 0.390µH 3R9 = 3.900µH 390 = 39.00µH 391 = 390.0µH 392 = 3900µH		T = Sn Plate	A = Standard	S = 13" Reel

ELECTRICAL CHARACTERISTICS

0404/04B4/04C4

Codes	L (µH)	Tolerance	Test Condition	DCR (Ω) max.			I sat (A) max*		
				0404	04B4	04C4	0404	04B4	04C4
R47	0.47	N	100KHz, 0.25V	–	0.017	–	–	1.840	–
1R0	1.0	M, N	100KHz, 0.25V	0.060	0.030	–	1.600	1.800	–
1R2	1.2	M, N	100KHz, 0.25V	0.065	0.043	–	1.400	1.700	–
1R5	1.5	M, N	100KHz, 0.25V	0.077	0.052	0.015	1.240	1.600	1.900
1R8	1.8	M, N	100KHz, 0.25V	0.093	–	0.018	1.220	–	1.760
2R2	2.2	M, N	100KHz, 0.25V	0.125	0.058	0.020	1.200	1.500	1.670
2R4	2.4	M, N	100KHz, 0.25V	0.139	–	0.022	0.980	–	1.650
2R5	2.5	M, N	100KHz, 0.25V	–	0.059	–	–	1.400	–
2R7	2.7	M, N	100KHz, 0.25V	–	0.059	0.028	–	1.400	1.450
3R3	3.3	M, N	100KHz, 0.25V	0.187	0.064	0.032	0.890	1.300	1.440
3R5	3.5	M, N	100KHz, 0.25V	0.210	0.127	–	0.850	1.300	–
3R6	3.6	M, N	100KHz, 0.25V	–	–	0.035	–	–	1.430
3R9	3.9	M, N	100KHz, 0.25V	0.220	0.135	0.037	0.780	1.120	1.320
4R3	4.3	M, N	100KHz, 0.25V	–	–	0.043	–	–	1.000
4R7	4.7	M, N	100KHz, 0.25V	0.240	0.146	0.045	0.710	1.100	0.970
5R1	5.1	M, N	100KHz, 0.25V	–	–	0.046	–	–	0.940
5R6	5.6	M, N	100KHz, 0.25V	0.320	0.176	–	0.620	0.950	–
6R2	6.2	M, N	100KHz, 0.25V	–	0.220	–	–	0.910	–
6R8	6.8	M, N	100KHz, 0.25V	0.350	0.238	0.065	0.570	0.900	0.870
7R5	7.5	M, N	100KHz, 0.25V	–	–	0.079	–	–	0.820
8R2	8.2	M, N	100KHz, 0.25V	0.470	0.272	0.071	0.520	0.800	0.770
100	10	M	1KHz, 0.25V	0.570	0.299	0.105	0.470	0.700	0.700
120	12	M	1KHz, 0.25V	0.750	–	0.119	0.430	–	0.670
150	15	M	1KHz, 0.25V	0.810	0.472	0.140	0.380	0.610	0.540
180	18	M	1KHz, 0.25V	1.060	–	0.175	0.350	–	0.500
220	22	M	1KHz, 0.25V	1.150	0.592	0.201	0.320	0.520	0.480
270	27	M	1KHz, 0.25V	1.670	0.630	0.227	0.290	0.440	0.400
330	33	M	1KHz, 0.25V	1.840	1.075	0.287	0.280	0.430	0.350
390	39	M	1KHz, 0.25V	2.310	–	0.341	0.250	–	0.330
470	47	M	1KHz, 0.25V	2.630	1.309	0.430	0.220	0.340	0.320
560	56	M	1KHz, 0.25V	2.860	–	0.471	0.200	–	0.300
680	68	M	1KHz, 0.25V	3.940	2.613	0.532	0.180	0.250	0.270
820	82	M	1KHz, 0.25V	4.900	2.950	0.675	0.160	0.200	0.230
101	100	M	1KHz, 0.25V	5.740	3.255	0.850	0.140	0.190	0.210
121	120	M	1KHz, 0.25V	7.310	–	1.110	0.130	–	0.200
151	150	M	1KHz, 0.25V	9.080	3.550	1.230	0.120	0.120	0.170
181	180	M	1KHz, 0.25V	9.500	–	1.560	0.110	–	0.150
221	220	M	1KHz, 0.25V	–	4.900	1.800	–	0.090	0.140
271	270	M	1KHz, 0.25V	–	–	2.200	–	–	0.130
331	330	M	1KHz, 0.25V	–	7.280	2.640	–	0.080	0.120
471	470	M	1KHz, 0.25V	–	–	3.820	–	–	0.100
561	560	M	1KHz, 0.25V	–	–	4.620	–	–	0.090
681	680	M	1KHz, 0.25V	–	13.370	–	–	0.070	–
102	1000	M	1KHz, 0.25V	–	19.550	–	–	0.065	–
152	1500	M	1KHz, 0.25V	–	36.150	–	–	0.038	–
182	1800	M	1KHz, 0.25V	–	57.620	–	–	0.036	–

*Saturation Current (0404/04B4): The DC current when the inductance becomes 30% lower than its initial value. (Ta=25°C)

*Saturation Current (04C4): The DC current when the inductance becomes 35% lower than its initial value. (Ta=25°C)



LMax SMD Power Inductor



LMXS Series – Shielded Style C

0505/05B5/05C5

Codes	L (μ H)	Tolerance	Test Condition	DCR (Ω) max.			I sat (A) max*		
				0505	05B5	05C5	0505	05B5	05C5
1R0	1.0	M, N	100KHz, 0.25V	–	0.030	0.015	–	2.700	4.000
1R1	1.1	M, N	100KHz, 0.25V	–	–	0.020	–	–	3.870
1R2	1.2	M, N	100KHz, 0.25V	0.050	0.044	0.022	1.770	2.150	3.800
1R5	1.5	M, N	100KHz, 0.25V	0.069	–	–	1.710	–	–
2R0	2.0	M, N	100KHz, 0.25V	0.100	0.046	0.027	1.440	1.900	2.920
2R2	2.2	M, N	100KHz, 0.25V	0.110	0.059	0.029	1.400	1.630	2.410
3R3	3.3	M, N	100KHz, 0.25V	0.140	0.062	0.034	1.140	1.500	2.360
3R5	3.5	M, N	100KHz, 0.25V	0.150	0.073	–	1.100	1.340	–
4R1	4.1	M, N	100KHz, 0.25V	–	0.081	–	–	1.200	–
4R7	4.7	M, N	100KHz, 0.25V	0.190	0.087	0.045	0.950	1.140	1.870
5R6	5.6	M, N	100KHz, 0.25V	0.193	0.093	0.052	0.900	1.000	1.600
6R2	6.2	M, N	100KHz, 0.25V	0.200	–	–	0.840	–	–
6R8	6.8	M, N	100KHz, 0.25V	0.200	0.105	0.068	0.800	0.950	1.510
8R2	8.2	M, N	100KHz, 0.25V	0.300	0.139	0.084	0.750	0.900	1.380
100	10	M	1KHz, 0.25V	0.350	0.150	0.090	0.660	0.760	1.330
120	12	M	1KHz, 0.25V	0.430	0.170	–	0.620	0.660	–
150	15	M	1KHz, 0.25V	0.440	0.210	0.142	0.590	0.630	1.050
180	18	M	1KHz, 0.25V	0.750	–	–	0.570	–	–
220	22	M	1KHz, 0.25V	0.820	0.275	0.208	0.560	0.560	0.860
270	27	M	1KHz, 0.25V	–	–	0.222	–	–	0.750
330	33	M	1KHz, 0.25V	1.160	0.455	0.257	0.430	0.440	0.720
390	39	M	1KHz, 0.25V	–	0.540	–	–	0.380	–
470	47	M	1KHz, 0.25V	1.590	0.730	0.352	0.340	0.350	0.620
560	56	M	1KHz, 0.25V	–	0.800	–	–	0.320	–
680	68	M	1KHz, 0.25V	2.140	0.935	0.525	0.290	0.300	0.510
820	82	M	1KHz, 0.25V	2.720	–	–	0.250	–	–
101	100	M	1KHz, 0.25V	3.550	1.500	0.801	0.220	0.230	0.430
121	120	M	1KHz, 0.25V	4.890	1.910	0.850	0.200	0.220	0.340
151	150	M	1KHz, 0.25V	5.200	2.680	1.100	0.190	0.210	0.260
181	180	M	1KHz, 0.25V	7.550	3.045	1.190	0.170	0.200	0.240
221	220	M	1KHz, 0.25V	7.760	3.520	1.530	0.150	0.195	0.200
271	270	M	1KHz, 0.25V	10.13	4.380	–	0.145	0.193	–
331	330	M	1KHz, 0.25V	11.23	5.560	2.030	0.140	0.190	0.190
391	390	M	1KHz, 0.25V	–	–	3.000	–	–	0.160
471	470	M	1KHz, 0.25V	16.86	7.820	3.500	0.098	0.180	0.150
561	560	M	1KHz, 0.25V	22.78	9.790	4.450	0.097	0.170	0.140
681	680	M	1KHz, 0.25V	24.87	–	–	0.085	–	–
821	820	M	1KHz, 0.25V	28.09	15.00	–	0.077	0.120	–
102	1000	M	1KHz, 0.25V	45.07	–	–	0.067	–	–
122	1200	M	1KHz, 0.25V	–	–	8.500	–	–	0.070
152	1500	M	1KHz, 0.25V	–	–	10.00	–	–	0.065
182	1800	M	1KHz, 0.25V	–	–	13.15	–	–	0.062
222	2200	M	1KHz, 0.25V	–	–	19.00	–	–	0.050
252	2500	M	1KHz, 0.25V	–	–	20.00	–	–	0.045

*Saturation Current (0707/07B7/07D7): The DC current when the inductance becomes 30% lower than its initial value.

LMax SMD Power Inductor



LMXS Series – Shielded Style C

0707/07B7/07D7

Codes	L (μ H)	Tolerance	Test Condition	DCR (Ω) max.			I sat (A) max*		
				0707	07B7	07D7	0707	07B7	07D7
R36	0.36	N	100KHz, 0.25V	–	–	0.005	–	–	9.240
R56	0.56	N	100KHz, 0.25V	–	–	0.006	–	–	8.500
R80	0.80	N	100KHz, 0.25V	–	–	0.009	–	–	5.800
1R0	1.0	M, N	100KHz, 0.25V	0.050	0.035	0.040	3.280	3.520	2.100
1R2	1.2	M, N	100KHz, 0.25V	–	–	0.040	–	–	2.100
1R5	1.5	M, N	100KHz, 0.25V	0.067	–	0.040	2.530	–	2.100
1R8	1.8	M, N	100KHz, 0.25V	–	0.052	0.040	–	3.050	2.090
2R0	2.0	M, N	100KHz, 0.25V	0.085	–	–	2.060	–	–
2R2	2.2	M, N	100KHz, 0.25V	–	0.071	0.0410	–	2.500	2.080
2R5	2.5	M, N	100KHz, 0.25V	–	–	0.0410	–	–	2.080
2R7	2.7	M, N	100KHz, 0.25V	0.110	–	–	1.870	–	–
3R0	3.0	M, N	100KHz, 0.25V	–	0.086	–	–	2.150	–
3R3	3.3	M, N	100KHz, 0.25V	0.130	–	0.0410	1.580	–	2.070
3R9	3.9	M, N	100KHz, 0.25V	0.160	0.110	–	1.460	2.010	–
4R3	4.3	M, N	100KHz, 0.25V	–	–	0.041	–	–	2.060
4R7	4.7	M, N	100KHz, 0.25V	0.200	0.130	0.042	1.300	1.950	2.050
5R6	5.6	M, N	100KHz, 0.25V	0.230	0.150	0.043	1.220	1.820	2.040
6R8	6.8	M, N	100KHz, 0.25V	0.280	0.170	0.044	1.160	1.670	2.040
8R2	8.2	M, N	100KHz, 0.25V	0.310	0.190	–	1.130	1.520	–
100	10	M	1KHz, 0.25V	0.330	0.240	0.049	1.030	1.390	2.000
120	12	M	1KHz, 0.25V	0.460	0.290	0.058	0.870	1.220	1.900
150	15	M	1KHz, 0.25V	0.530	0.380	0.081	0.800	1.090	1.600
180	18	M	1KHz, 0.25V	0.620	0.440	0.091	0.730	1.030	1.480
220	22	M	1KHz, 0.25V	0.700	0.490	0.110	0.710	0.950	1.320
270	27	M	1KHz, 0.25V	0.910	0.640	0.150	0.650	0.840	1.260
330	33	M	1KHz, 0.25V	1.150	0.740	0.170	0.570	0.800	1.100
390	39	M	1KHz, 0.25V	1.380	0.910	0.230	0.500	0.750	1.050
470	47	M	1KHz, 0.25V	1.540	1.020	0.260	0.480	0.690	1.000
560	56	M	1KHz, 0.25V	1.860	1.260	0.350	0.450	0.630	0.850
680	68	M	1KHz, 0.25V	2.320	1.570	0.380	0.410	0.560	0.780
820	82	M	1KHz, 0.25V	2.540	1.890	0.430	0.370	0.510	0.740
101	100	M	1KHz, 0.25V	3.20	2.12	0.61	0.32	0.47	0.70
121	120	M	1KHz, 0.25V	4.24	2.55	0.66	0.29	0.42	0.60
151	150	M	1KHz, 0.25V	4.77	3.37	0.88	0.27	0.37	0.52
181	180	M	1KHz, 0.25V	6.04	3.73	0.98	0.24	0.32	0.46
221	220	M	1KHz, 0.25V	7.95	4.54	1.17	0.22	0.29	0.40
271	270	M	1KHz, 0.25V	10.51	5.97	1.64	0.19	0.25	0.36
331	330	M	1KHz, 0.25V	11.63	7.74	1.86	0.18	0.23	0.32
391	390	M	1KHz, 0.25V	12.97	9.92	2.85	0.16	0.21	0.28
471	470	M	1KHz, 0.25V	16.87	12.95	3.01	0.15	0.18	0.26
561	560	M	1KHz, 0.25V	22.3	14.36	3.62	0.13	0.16	0.24
681	680	M	1KHz, 0.25V	25.11	18.52	4.63	0.12	0.14	0.22
821	820	M	1KHz, 0.25V	28.41	20.23	5.20	0.10	0.13	0.20
102	1000	M	1KHz, 0.25V	–	28.25	6.00	–	0.11	0.18
122	1200	M	1KHz, 0.25V	–	31.85	–	–	0.10	–
152	1500	M	1KHz, 0.25V	–	36.72	–	–	0.095	–

*Saturation Current (0707/07B7/07D7): The DC current when the inductance becomes 30% lower than its initial value.

LMax SMD Power Inductor



LMXS Series – Shielded Style C

101B/101D/101H

Codes	L (μ H)	Tolerance	Test Condition	DCR (Ω) max.			I sat (A) max*		
				101B	101D	101H	101B	101D	101H
R56	0.56	N	100KHz, 0.25V	–	0.006	0.006	–	12.60	10.18
R80	0.80	N	100KHz, 0.25V	–	0.006	–	–	12.00	–
1R0	1.0	M, N	100KHz, 0.25V	0.038	0.008	0.007	4.10	10.30	9.52
1R5	1.5	M, N	100KHz, 0.25V	–	0.0081	0.008	–	10.00	9.50
1R6	1.6	M, N	100KHz, 0.25V	–	–	0.008	–	–	9.50
1R8	1.8	M, N	100KHz, 0.25V	0.047	–	0.008	3.50	–	6.30
2R2	2.2	M, N	100KHz, 0.25V	–	0.01	0.009	–	8.00	5.82
2R4	2.4	M, N	100KHz, 0.25V	–	–	0.009	–	–	5.71
2R5	2.5	M, N	100KHz, 0.25V	–	0.011	–	–	7.50	–
2R7	2.7	M, N	100KHz, 0.25V	0.059	0.012	–	3.40	7.00	–
3R3	3.3	M, N	100KHz, 0.25V	0.063	0.012	0.010	3.00	6.60	5.18
3R8	3.8	M, N	100KHz, 0.25V	–	0.013	0.010	–	6.00	5.09
4R3	4.3	M, N	100KHz, 0.25V	–	–	0.011	–	–	5.08
4R7	4.7	M, N	100KHz, 0.25V	0.086	0.022	0.015	2.60	5.70	5.00
5R2	5.2	M, N	100KHz, 0.25V	–	0.022	0.016	–	5.50	3.25
5R6	5.6	M, N	100KHz, 0.25V	0.098	0.024	0.016	2.20	5.15	3.2
6R8	6.8	M, N	100KHz, 0.25V	0.110	0.026	0.017	2.10	4.90	2.80
7R0	7.0	M, N	100KHz, 0.25V	–	0.027	–	–	4.80	–
8R2	8.2	M, N	100KHz, 0.25V	0.130	0.032	–	1.90	4.45	–
100	10	M	1KHz, 0.25V	0.160	0.035	0.028	1.80	4.40	2.15
120	12	M	1KHz, 0.25V	0.190	0.040	–	1.48	3.65	–
150	15	M	1KHz, 0.25V	0.250	0.050	–	1.25	3.6	–
180	18	M	1KHz, 0.25V	0.290	0.060	–	1.22	2.95	–
220	22	M	1KHz, 0.25V	0.300	0.073	–	1.20	2.90	–
250	25	M	1KHz, 0.25V	–	0.080	–	–	2.60	–
270	27	M	1KHz, 0.25V	0.400	–	–	0.93	–	–
330	33	M	1KHz, 0.25V	0.460	0.093	–	0.89	2.30	–
390	39	M	1KHz, 0.25V	0.570	–	0.050	0.81	–	1.30
470	47	M	1KHz, 0.25V	0.630	0.128	–	0.80	2.10	–
560	56	M	1KHz, 0.25V	0.780	–	–	0.72	–	–
680	68	M	1KHz, 0.25V	0.990	0.213	–	0.64	1.50	–
820	82	M	1KHz, 0.25V	1.170	–	–	0.61	–	–
101	100	M	1KHz, 0.25V	1.30	0.304	–	0.60	1.35	–
121	120	M	1KHz, 0.25V	1.63	0.340	–	0.51	1.18	–
151	150	M	1KHz, 0.25V	2.02	0.506	–	0.43	1.15	–
181	180	M	1KHz, 0.25V	2.29	0.530	–	0.41	0.98	–
221	220	M	1KHz, 0.25V	2.96	0.756	–	0.36	0.92	–
271	270	M	1KHz, 0.25V	3.57	0.782	–	0.33	0.72	–
331	330	M	1KHz, 0.25V	4.50	1.090	–	0.30	0.70	–
391	390	M	1KHz, 0.25V	–	1.102	–	–	0.55	–
471	470	M	1KHz, 0.25V	6.16	1.292	–	0.25	0.45	–
561	560	M	1KHz, 0.25V	7.63	1.572	–	0.24	0.40	–
681	680	M	1KHz, 0.25V	9.06	1.882	–	0.21	0.35	–
821	820	M	1KHz, 0.25V	11.30	2.382	–	0.19	0.32	–
102	1000	M	1KHz, 0.25V	12.80	2.692	–	0.17	0.28	–
122	1200	M	1KHz, 0.25V	16.50	–	–	0.16	–	–
152	1500	M	1KHz, 0.25V	21.30	–	–	0.14	–	–
182	1800	M	1KHz, 0.25V	27.80	–	–	0.12	–	–
222	2200	M	1KHz, 0.25V	32.00	–	–	0.10	–	–

*Saturation Current (1010/101D/101H): The DC current when the inductance becomes 35% lower than its initial value. (Ta=25°C)

LMax SMD Power Inductor



LMXS Series – Shielded Style D

FEATURES

- Magnetically shielded against radiation
- 0704 can help achieve longer battery life significantly in handheld communication devices.
- 1309 / 1915 designed for the higher current requirements of portable computers.
- 0704 has ceramic base with gold-plating
- 1309 / 1915 has LCP plastic base

APPLICATIONS

- Portable Telephones
- Personal Computers
- Other Various Electronic Appliances
- DC/DC Converters, etc.

CHARACTERISTICS

- Saturation Rated Current (IDC): The DC current when the inductance becomes 10% lower than its initial value. (Ta=25°C)
- Temperature Rise Current (I rms): The actual current when temperature of coil becomes Δ40°C. (Ta=25°C)
- Operating temperature range: -40 ~ 85°C

INDUCTANCE AND RATED CURRENT RANGES

- 0704 1.0 ~ 10000μH 3.0 ~ 0.02A
- 1309 1.0 ~ 1000μH 5.0 ~ 0.17A
- 1915 10 ~ 1000μH 3.9 ~ 0.53A
- Electrical specifications at 25°C



DIMENSIONS

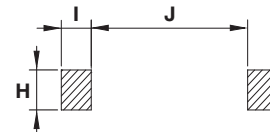
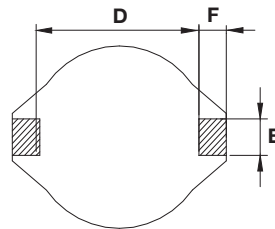
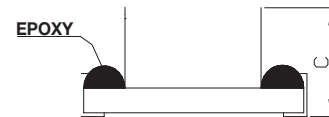
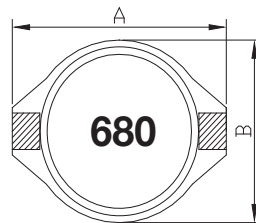

mm (inches)

Type	A max.	B max.	C max.	D	E	F	H	I	J
0704	6.60 (0.260)	4.45 (0.175)	2.92 (0.115)	4.32 (0.170)	1.27 (0.050)	1.02 (0.040)	3.56 (0.140)	1.40 (0.055)	4.06 (0.160)
1309	12.95 (0.510)	9.40 (0.370)	5.21 (0.205)	7.62 (0.300)	2.54 (0.100)	2.54 (0.100)	2.79 (0.110)	2.92 (0.115)	7.37 (0.290)
1915	18.54 (0.730)	15.24 (0.600)	7.62 (0.300)	12.70 (0.500)	2.54 (0.100)	2.54 (0.100)	2.79 (0.110)	2.92 (0.115)	12.45 (0.490)

HOW TO ORDER

LM	XS	0704	M	R04	D	T	A	S
Family	Series	Size	Tolerance	Inductance	Style	Termination	Special	Packaging
LM = Power Inductor	XS = Shielded	0704 = 7x4xh 1309 = 13x9xh (h = see catalog)	M = ±20%	R04 = 0.039μH R39 = 0.390μH 3R9 = 3.900μH 390 = 39.00μH 391 = 390.0μH 392 = 3900μH	T = Sn Plate	A = Standard	S = 13" Reel	



LMax SMD Power Inductor



LMXS Series – Shielded Style D

ELECTRICAL CHARACTERISTICS

0704

Codes	L (μ H)	Tolerance	Test Condition		DCR (Ω) max.	SRF ref (MHz)	Q min.	I rms (A) max.
			L	Q				
1R0	1.0	M	100KHz, 0.1V	200KHz, 0.1V	0.040	250	30	3.00
1R5	1.5	M	100KHz, 0.1V	200KHz, 0.1V	0.045	125	30	2.30
2R2	2.2	M	100KHz, 0.1V	200KHz, 0.1V	0.050	120	40	1.80
3R3	3.3	M	100KHz, 0.1V	200KHz, 0.1V	0.055	120	40	1.60
4R7	4.7	M	100KHz, 0.1V	200KHz, 0.1V	0.060	105	40	1.40
6R8	6.8	M	100KHz, 0.1V	200KHz, 0.1V	0.065	50	40	1.20
100	10	M	100KHz, 0.1V	200KHz, 0.1V	0.075	38	40	1.00
150	15	M	100KHz, 0.1V	100KHz, 0.1V	0.090	33	40	0.80
220	22	M	100KHz, 0.1V	100KHz, 0.1V	0.11	25	40	0.70
330	33	M	100KHz, 0.1V	100KHz, 0.1V	0.19	20	40	0.60
470	47	M	100KHz, 0.1V	100KHz, 0.1V	0.23	20	40	0.50
680	68	M	100KHz, 0.1V	100KHz, 0.1V	0.29	15	40	0.40
101	100	M	100KHz, 0.1V	100KHz, 0.1V	0.48	10	40	0.30
151	150	M	100KHz, 0.1V	100KHz, 0.1V	0.59	9	40	0.26
221	220	M	100KHz, 0.1V	100KHz, 0.1V	0.90	6	40	0.22
331	330	M	100KHz, 0.1V	100KHz, 0.1V	1.40	5	40	0.20
471	470	M	100KHz, 0.1V	100KHz, 0.1V	1.80	4	40	0.19
681	680	M	100KHz, 0.1V	100KHz, 0.1V	2.20	3	40	0.18
102	1000	M	100KHz, 0.1V	100KHz, 0.1V	3.40	2	40	0.15
152	1500	M	100KHz, 0.1V	100KHz, 0.1V	4.20	2	50	0.12
222	2200	M	100KHz, 0.1V	100KHz, 0.1V	8.50	2	50	0.10
332	3300	M	100KHz, 0.1V	100KHz, 0.1V	11.0	1	50	0.08
472	4700	M	100KHz, 0.1V	100KHz, 0.1V	13.9	1	50	0.06
682	6800	M	100KHz, 0.1V	100KHz, 0.1V	25.0	1	50	0.04
103	10000	M	100KHz, 0.1V	100KHz, 0.1V	32.8	0.8	50	0.02

1309

Codes	L (μ H)	Tolerance	Test Condition	DCR (Ω) max.	SRF ref (MHz)	IDC (A) max	I rms (A) max.
1R0	1.0	M	100KHz, 0.1V	0.021	140	5.6	5.0
1R5	1.5	M	100KHz, 0.1V	0.022	120	5.2	4.5
2R2	2.2	M	100KHz, 0.1V	0.032	80	5.0	3.8
3R3	3.3	M	100KHz, 0.1V	0.039	70	3.9	3.3
4R7	4.7	M	100KHz, 0.1V	0.054	40	3.2	2.7
6R8	6.8	M	100KHz, 0.1V	0.075	38	2.8	2.2
100	10	M	100KHz, 0.1V	0.101	35	2.4	2.0
150	15	M	100KHz, 0.1V	0.150	25	2.0	1.5
220	22	M	100KHz, 0.1V	0.207	19	1.6	1.3
330	33	M	100KHz, 0.1V	0.334	15	1.4	1.1
470	47	M	100KHz, 0.1V	0.472	13	1.0	0.8
680	68	M	100KHz, 0.1V	0.660	10	0.9	0.7
101	100	M	100KHz, 0.1V	1.110	7	0.8	0.6
151	150	M	100KHz, 0.1V	1.550	6	0.6	0.5
221	220	M	100KHz, 0.1V	2.000	5	0.5	0.37
102	1000	M	100KHz, 0.1V	8.300	2	0.32	0.17

LMax SMD Power Inductor



LMXS Series – Shielded Style D

1915

Codes	L (μ H)	Tolerance	Test Condition	DCR (Ω) max.	SRF ref (MHz)	IDC (A) max.	I rms (A) max.
100	10	M	100KHz, 0.1V	0.040	30	8.0	3.9
150	15	M	100KHz, 0.1V	0.048	20	7.00	3.4
220	22	M	100KHz, 0.1V	0.059	18	6.00	3.1
330	33	M	100KHz, 0.1V	0.075	14	5.00	2.8
470	47	M	100KHz, 0.1V	0.097	10	4.00	2.4
680	68	M	100KHz, 0.1V	0.138	9.0	3.00	2.0
101	100	M	100KHz, 0.1V	0.207	7.0	2.40	1.7
151	150	M	100KHz, 0.1V	0.293	6.0	2.10	1.3
221	220	M	100KHz, 0.1V	0.470	5.0	1.90	1.1
331	330	M	100KHz, 0.1V	0.780	4.0	1.10	0.86
471	470	M	100KHz, 0.1V	1.080	3.0	1.10	0.73
681	680	M	100KHz, 0.1V	1.400	2.5	0.96	0.64
102	1000	M	100KHz, 0.1V	2.010	2.0	0.80	0.53

LMax SMD Power Inductor



LMXS Series – Shielded Style F

FEATURES

- Magnetically Shielded Construction
- Large Current
- Low DCR

APPLICATIONS

- Telephones
- PCs
- Notebooks
- Hard Disk Drives
- Peripherals

CHARACTERISTICS

- Rated Current (IDC): The DC current that will cause an approximate ΔT of 40°C. ($T_a=25^\circ\text{C}$)
- Operating temperature range: $-40^\circ\text{C} \sim +125^\circ\text{C}$

INDUCTANCE AND RATED CURRENT RANGES

- 0606 4.7 μH ~ 100.0 μH 1.50 ~ 0.33A
- 06C6 4.7 μH ~ 100.0 μH 1.60 ~ 0.42A
- 0707 3.3 μH ~ 47.0 μH 1.60 ~ 0.54A
- 07C7 3.3 μH ~ 1000.0 μH 1.90 ~ 0.13A
- 07E7 3.3 μH ~ 1000.0 μH 2.30 ~ 0.14A
- 1010 10.0 μH ~ 1500.0 μH 2.50 ~ 0.22A
- 1313 6.0 μH ~ 1500.0 μH 3.60 ~ 0.29A
- 131H 2.0 μH ~ 220.0 μH 6.20 ~ 1.00A
- 131J 1.2 μH ~ 220.0 μH 8.20 ~ 1.30A
- Electrical specifications at 25°C



DIMENSIONS

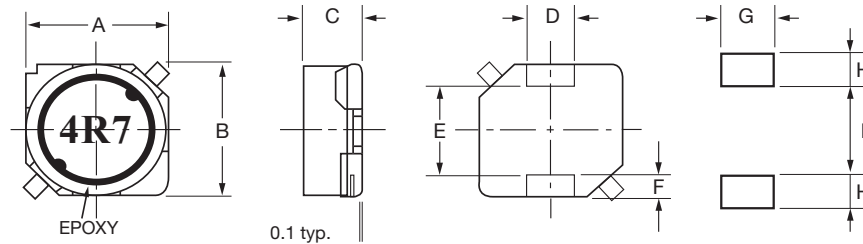

mm (inches)

Type	A	B	C	D	E	F	G	H	I
0606	6.00 ± 0.20 (0.236 ± 0.008)	6.00 ± 0.20 (0.236 ± 0.008)	2.50 ± 0.20 (0.099 ± 0.008)	2.00 ± 0.10 (0.079 ± 0.004)	3.00 typ (0.118 typ)	1.50 typ (0.059 typ)	2.20 (0.087)	2.00 (0.079)	2.60 (0.103)
06C6	6.00 ± 0.20 (0.236 ± 0.008)	6.00 ± 0.20 (0.236 ± 0.008)	2.80 ± 0.20 (0.110 ± 0.008)	2.00 ± 0.10 (0.079 ± 0.004)	3.00 typ (0.118 typ)	1.50 typ (0.059 typ)	2.20 (0.087)	2.00 (0.079)	2.60 (0.103)
0707	7.00 ± 0.20 (0.276 ± 0.008)	7.00 ± 0.20 (0.276 ± 0.008)	2.80 ± 0.20 (0.110 ± 0.008)	2.00 ± 0.10 (0.079 ± 0.004)	4.00 typ (0.193 typ)	1.50 typ (0.059 typ)	2.20 (0.087)	2.00 (0.079)	3.60 (0.103)
07C7	7.00 ± 0.20 (0.276 ± 0.008)	7.00 ± 0.20 (0.276 ± 0.008)	3.20 ± 0.20 (0.126 ± 0.008)	2.00 ± 0.10 (0.079 ± 0.004)	4.00 typ (0.193 typ)	1.50 typ (0.059 typ)	2.20 (0.087)	2.00 (0.079)	3.60 (0.142)
07E7	7.00 ± 0.20 (0.276 ± 0.008)	7.00 ± 0.20 (0.276 ± 0.008)	4.50 ± 0.30 (0.177 ± 0.012)	2.00 ± 0.10 (0.079 ± 0.004)	4.00 typ (0.193 typ)	1.50 typ (0.059 typ)	2.20 (0.087)	2.00 (0.079)	3.60 (0.142)
1010	10.1 ± 0.30 (0.398 ± 0.012)	10.1 ± 0.30 (0.398 ± 0.012)	4.50 ± 0.30 (0.177 ± 0.012)	3.00 ± 0.10 (0.118 ± 0.004)	6.00 ± 0.20 (0.236 ± 0.008)	2.00 ± 0.15 (0.079 ± 0.006)	3.20 (0.126)	2.50 (0.099)	5.60 (0.220)
1313	12.5 ± 0.30 (0.492 ± 0.012)	12.5 ± 0.30 (0.492 ± 0.012)	5.50 ± 0.30 (0.217 ± 0.012)	3.00 ± 0.10 (0.118 ± 0.004)	8.60 ± 0.30 (0.339 ± 0.012)	2.00 ± 0.15 (0.079 ± 0.006)	3.20 (0.126)	2.50 (0.099)	8.20 (0.322)
131H	12.5 ± 0.30 (0.492 ± 0.012)	12.5 ± 0.30 (0.492 ± 0.012)	6.50 ± 0.35 (0.256 ± 0.014)	3.00 ± 0.10 (0.118 ± 0.004)	8.60 ± 0.30 (0.339 ± 0.012)	2.00 ± 0.15 (0.079 ± 0.006)	3.20 (0.126)	2.50 (0.099)	8.20 (0.322)
131J	12.5 ± 0.30 (0.492 ± 0.012)	12.5 ± 0.30 (0.492 ± 0.012)	7.50 ± 0.35 (0.295 ± 0.014)	3.00 ± 0.10 (0.118 ± 0.004)	8.60 ± 0.30 (0.339 ± 0.012)	2.00 ± 0.15 (0.079 ± 0.006)	3.20 (0.126)	2.50 (0.099)	8.20 (0.322)

HOW TO ORDER

LM	XS	0707	M	2R2	F	T	A	S
Family	Series	Size	Tolerance	Inductance	Style	Termination	Special	Packaging
LM = Power Inductor	XS = Shielded	0707 = 7x7xh 07C7 = 7x7xC(h) (h = see catalog)	M = ±20%	2R2 = 2.20 μH 680 = 68.0 μH 152 = 1500 μH		T = Sn Plate	A = Standard	S = 13" Reel



LMax SMD Power Inductor



LMXS Series – Shielded Style F

ELECTRICAL CHARACTERISTICS

0606

Codes	L (μH)	Tolerance	Test Condition	DCR (Ω) max.	IDC (A) max.
4R7	4.7	M	100KHz, 1.0V	0.050	1.50
6R8	6.8	M	100KHz, 1.0V	0.080	1.30
100	10	M	100KHz, 1.0V	0.098	1.00
150	15	M	100KHz, 1.0V	0.140	0.88
220	22	M	100KHz, 1.0V	0.208	0.73
330	33	M	100KHz, 1.0V	0.310	0.59
470	47	M	100KHz, 1.0V	0.390	0.48
680	68	M	100KHz, 1.0V	0.540	0.42
101	100	M	100KHz, 1.0V	0.810	0.33

06C6

Codes	L (μH)	Tolerance	Test Condition	DCR (Ω) max.	IDC (A) max.
4R7	4.7	M	100KHz, 1.0V	0.050	1.60
6R8	6.8	M	100KHz, 1.0V	0.073	1.50
100	10	M	100KHz, 1.0V	0.098	1.30
150	15	M	100KHz, 1.0V	0.128	1.00
220	22	M	100KHz, 1.0V	0.172	0.77
330	33	M	100KHz, 1.0V	0.290	0.69
470	47	M	100KHz, 1.0V	0.420	0.59
680	68	M	100KHz, 1.0V	0.533	0.50
101	100	M	100KHz, 1.0V	0.730	0.42

0707

Codes	L (μH)	Tolerance	Test Condition	DCR (Ω) max.	IDC (A) max.
3R3	3.3	M	100KHz, 1.0V	0.045	1.60
4R7	4.7	M	100KHz, 1.0V	0.054	1.50
6R8	6.8	M	100KHz, 1.0V	0.071	1.30
100	10	M	100KHz, 1.0V	0.100	1.10
150	15	M	100KHz, 1.0V	0.156	0.88
220	22	M	100KHz, 1.0V	0.220	0.75
330	33	M	100KHz, 1.0V	0.290	0.65
470	47	M	100KHz, 1.0V	0.410	0.54

07C7

Codes	L (μH)	Tolerance	Test Condition	DCR (Ω) max.	IDC (A) max.
3R3	3.3	M	100KHz, 1.0V	0.028	1.90
4R7	4.7	M	100KHz, 1.0V	0.044	1.70
6R8	6.8	M	100KHz, 1.0V	0.050	1.60
100	10	M	100KHz, 1.0V	0.064	1.40
150	15	M	100KHz, 1.0V	0.090	1.10
220	22	M	100KHz, 1.0V	0.132	0.96
330	33	M	100KHz, 1.0V	0.192	0.75
470	47	M	100KHz, 1.0V	0.290	0.67
680	68	M	100KHz, 1.0V	0.372	0.59
101	100	M	100KHz, 1.0V	0.540	0.45
151	150	M	100KHz, 1.0V	0.780	0.37
221	220	M	100KHz, 1.0V	1.260	0.29
331	330	M	100KHz, 1.0V	2.000	0.22
471	470	M	100KHz, 1.0V	2.460	0.20
681	680	M	100KHz, 1.0V	3.780	0.16
102	1000	M	100KHz, 1.0V	5.740	0.13

LMax SMD Power Inductor



LMXS Series – Shielded Style F

07E7

Codes	L (μH)	Tolerance	Test Condition	DCR (Ω) max.	IDC (A) max.
3R3	3.3	M	100KHz, 1.0V	0.024	2.30
4R7	4.7	M	100KHz, 1.0V	0.036	2.00
6R8	6.8	M	100KHz, 1.0V	0.047	1.70
100	10	M	100KHz, 1.0V	0.045	1.30
150	15	M	100KHz, 1.0V	0.063	1.10
220	22	M	100KHz, 1.0V	0.075	0.90
330	33	M	100KHz, 1.0V	0.120	0.82
470	47	M	100KHz, 1.0V	0.150	0.75
680	68	M	100KHz, 1.0V	0.210	0.60
101	100	M	100KHz, 1.0V	0.300	0.50
151	150	M	100KHz, 1.0V	0.410	0.40
221	220	M	100KHz, 1.0V	0.624	0.33
331	330	M	100KHz, 1.0V	0.890	0.25
471	470	M	100KHz, 1.0V	1.260	0.22
681	680	M	100KHz, 1.0V	1.780	0.20
102	1000	M	100KHz, 1.0V	2.740	0.14

1010

Codes	L (μH)	Tolerance	Test Condition	DCR (Ω) max.	IDC (A) max.
100	10	M	100KHz, 1.0V	0.044	2.50
150	15	M	100KHz, 1.0V	0.057	2.20
220	22	M	100KHz, 1.0V	0.071	1.90
330	33	M	100KHz, 1.0V	0.100	1.60
470	47	M	100KHz, 1.0V	0.120	1.40
680	68	M	100KHz, 1.0V	0.170	1.20
101	100	M	100KHz, 1.0V	0.240	1.00
151	150	M	100KHz, 1.0V	0.420	0.79
221	220	M	100KHz, 1.0V	0.570	0.65
331	330	M	100KHz, 1.0V	0.820	0.54
471	470	M	100KHz, 1.0V	1.240	0.47
681	680	M	100KHz, 1.0V	1.920	0.38
102	1000	M	100KHz, 1.0V	3.360	0.29
152	1500	M	100KHz, 1.0V	4.080	0.22

1313

Codes	L (μH)	Tolerance	Test Condition	DCR (Ω) max.	IDC (A) max.
6R0	6	M	100KHz, 1.0V	0.020	3.60
100	10	M	100KHz, 1.0V	0.026	3.40
150	15	M	100KHz, 1.0V	0.032	2.80
220	22	M	100KHz, 1.0V	0.041	2.30
330	33	M	100KHz, 1.0V	0.050	1.90
470	47	M	100KHz, 1.0V	0.075	1.60
680	68	M	100KHz, 1.0V	0.100	1.30
101	100	M	100KHz, 1.0V	0.140	1.10
151	150	M	100KHz, 1.0V	0.230	0.88
221	220	M	100KHz, 1.0V	0.330	0.72
331	330	M	100KHz, 1.0V	0.500	0.59
471	470	M	100KHz, 1.0V	0.630	0.49
681	680	M	100KHz, 1.0V	0.920	0.43
102	1000	M	100KHz, 1.0V	1.350	0.34
152	1500	M	100KHz, 1.0V	2.080	0.29

LMax SMD Power Inductor



LMXS Series – Shielded Style F

131H

Codes	L (μH)	Tolerance	Test Condition	DCR (Ω) max.	IDC (A) max.
2R0	2.0	M	100KHz,1.0V	0.014	6.20
4R2	4.2	M	100KHz,1.0V	0.018	5.50
7R0	7.0	M	100KHz,1.0V	0.022	5.00
100	10	M	100KHz,1.0V	0.025	4.80
150	15	M	100KHz,1.0V	0.029	4.20
220	22	M	100KHz,1.0V	0.038	3.50
330	33	M	100KHz,1.0V	0.049	2.80
470	47	M	100KHz,1.0V	0.070	2.40
680	68	M	100KHz,1.0V	0.095	2.00
101	100	M	100KHz,1.0V	0.150	1.60
221	220	M	100KHz,1.0V	0.330	1.00

131J

Codes	L (μH)	Tolerance	Test Condition	DCR (Ω) max.	IDC (A) max.
1R2	1.2	M	100KHz,1.0V	0.009	8.20
2R7	2.7	M	100KHz,1.0V	0.012	7.00
3R9	3.9	M	100KHz,1.0V	0.013	6.70
5R6	5.6	M	100KHz,1.0V	0.014	6.30
6R8	6.8	M	100KHz,1.0V	0.016	5.90
100	10	M	100KHz,1.0V	0.019	5.40
150	15	M	100KHz,1.0V	0.022	4.70
220	22	M	100KHz,1.0V	0.032	4.00
330	33	M	100KHz,1.0V	0.048	3.20
470	47	M	100KHz,1.0V	0.064	2.70
680	68	M	100KHz,1.0V	0.094	2.00
101	100	M	100KHz,1.0V	0.150	1.90
151	150	M	100KHz,1.0V	0.210	1.50
221	220	M	100KHz,1.0V	0.310	1.30

LMax SMD Power Inductor



LMXS Series – Shielded Style G

FEATURES

- Magnetically Shielded Construction
- Large Current
- Low DCR

APPLICATIONS

- LCD Televisions
- Notebooks
- Handheld Communication
- DC/DC Converters, etc.

CHARACTERISTICS

- Rated Current (IDC): The DC current that will cause an approximate ΔT of 40°C. ($T_a=25^\circ\text{C}$)
- Operating temperature range: $-40^\circ\text{C} \sim +125^\circ\text{C}$

INDUCTANCE AND RATED CURRENT RANGES

- 0707 10 μH ~ 1000 μH 1.68 ~ 0.16A
- 07D7 10 μH ~ 1000 μH 1.84 ~ 0.18A
- Electrical specifications at 25°C



DIMENSIONS

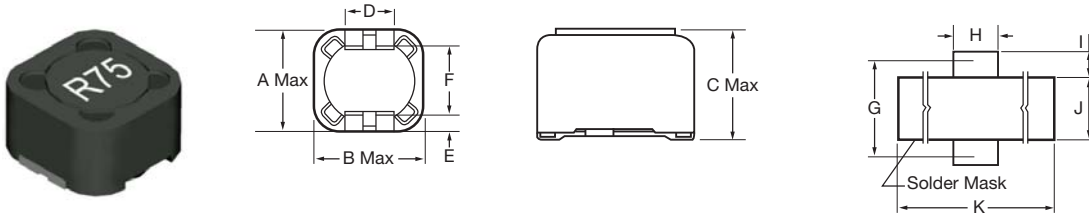

mm (inches)

Type	A max.	B max.	C max.	D	E	F	G	H	I	J	K
0707	7.50 (0.295)	7.50 (0.295)	3.50 (0.138)	2.00 (0.079)	1.10 (0.043)	5.08 (0.200)	6.30 (0.248)	3.00 (0.118)	1.91 (0.075)	4.50 (0.177)	10.5 (0.413)
07D7	7.50 (0.295)	7.50 (0.295)	4.50 (0.177)	2.00 (0.079)	1.10 (0.043)	5.08 (0.200)	6.30 (0.248)	3.00 (0.118)	1.91 (0.075)	4.50 (0.177)	10.5 (0.413)

HOW TO ORDER

LM	XS	0707	M	R04	G	T	A	S
Family	Series	Size	Tolerance	Inductance	Style	Termination	Special	Packaging
LM = Power Inductor	XS = Shielded	0707 = 7x7xh 07C7 = 7x7xC(h) (h = see catalog)	M = $\pm 20\%$	3R9 = 3.900 μH 390 = 39.00 μH 391 = 390 μH 102 = 1000 μH		T = Sn Plate	A = Standard	S = 13" Reel

LMax SMD Power Inductor



LMXS Series – Shielded Style G

ELECTRICAL CHARACTERISTICS

0707

Codes	L (μH)	Tolerance	Test Condition	DCR (Ω) max.	IDC (A) max.
100	10	M	100KHz, 1.0V	0.072	1.68
120	12	M	100KHz, 1.0V	0.098	1.52
150	15	M	100KHz, 1.0V	0.130	1.33
180	18	M	100KHz, 1.0V	0.140	1.20
220	22	M	100KHz, 1.0V	0.190	1.07
270	27	M	100KHz, 1.0V	0.210	0.96
330	33	M	100KHz, 1.0V	0.240	0.91
390	39	M	100KHz, 1.0V	0.320	0.77
470	47	M	100KHz, 1.0V	0.360	0.76
560	56	M	100KHz, 1.0V	0.470	0.68
680	68	M	100KHz, 1.0V	0.520	0.61
820	82	M	100KHz, 1.0V	0.690	0.57
101	100	M	100KHz, 1.0V	0.790	0.50
121	120	M	100KHz, 1.0V	0.890	0.49
151	150	M	100KHz, 1.0V	1.270	0.43
181	180	M	100KHz, 1.0V	1.450	0.39
221	220	M	100KHz, 1.0V	1.650	0.35
271	270	M	100KHz, 1.0V	2.310	0.32
331	330	M	100KHz, 1.0V	2.620	0.28
391	390	M	100KHz, 1.0V	2.940	0.26
471	470	M	100KHz, 1.0V	4.180	0.24
561	560	M	100KHz, 1.0V	4.670	0.22
681	680	M	100KHz, 1.0V	5.730	0.19
821	820	M	100KHz, 1.0V	6.540	0.18
102	1000	M	100KHz, 1.0V	9.440	0.16

07D7

Codes	L (μH)	Tolerance	Test Condition	DCR (Ω) max.	IDC (A) max.
100	10	M	100KHz, 1.0V	0.060	1.84
120	12	M	100KHz, 1.0V	0.070	1.71
150	15	M	100KHz, 1.0V	0.081	1.47
180	18	M	100KHz, 1.0V	0.091	1.31
220	22	M	100KHz, 1.0V	0.110	1.23
270	27	M	100KHz, 1.0V	0.150	1.12
330	33	M	100KHz, 1.0V	0.170	0.96
390	39	M	100KHz, 1.0V	0.230	0.91
470	47	M	100KHz, 1.0V	0.260	0.88
560	56	M	100KHz, 1.0V	0.350	0.75
680	68	M	100KHz, 1.0V	0.380	0.69
820	82	M	100KHz, 1.0V	0.430	0.61
101	100	M	100KHz, 1.0V	0.610	0.60
121	120	M	100KHz, 1.0V	0.660	0.52
151	150	M	100KHz, 1.0V	0.880	0.46
181	180	M	100KHz, 1.0V	0.980	0.42
221	220	M	100KHz, 1.0V	1.170	0.36
271	270	M	100KHz, 1.0V	1.640	0.34
331	330	M	100KHz, 1.0V	1.860	0.32
391	390	M	100KHz, 1.0V	2.850	0.29
561	560	M	100KHz, 1.0V	3.620	0.23
681	680	M	100KHz, 1.0V	4.630	0.22
821	820	M	100KHz, 1.0V	5.200	0.20
102	1000	M	100KHz, 1.0V	6.000	0.18

LMax SMD Power Inductor



LMXS Series – Shielded Style H

FEATURES

- Magnetically Shielded Construction
- Large Current
- Low DCR

APPLICATIONS

- LCD Televisions
- Notebooks
- Handheld Communication
- DC/DC Converters, etc.

CHARACTERISTICS

- Rated Current (IDC): The DC current that will cause an approximate ΔT of 40°C. (Ta=25°C)
- Operating temperature range: -40°C ~ +125°C

INDUCTANCE AND RATED CURRENT RANGES

- 1212 3.9 μ H ~ 330 μ H 6.5 ~ 0.50A
- 121G 2.4 μ H ~ 47 μ H 8.0 ~ 2.5A
- 121J 10 μ H ~ 1000 μ H 4.0 ~ 0.40A
- Electrical specifications at 25°C



DIMENSIONS

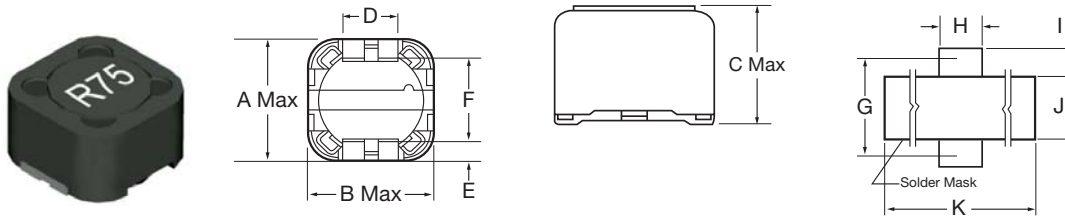

mm (inches)

Type	A max.	B max.	C max.	D	E	F	G	H	I	J	K
1212	12.5 (0.492)	12.5 (0.492)	4.50 (0.177)	5.00 (0.197)	2.00 (0.079)	7.60 (0.299)	10.00 (0.393)	6.00 (0.236)	3.00 (0.118)	7.00 (0.276)	18.0 (0.709)
121G	12.5 (0.492)	12.5 (0.492)	6.20 (0.244)	5.00 (0.197)	2.00 (0.079)	7.60 (0.299)	10.00 (0.394)	6.00 (0.236)	3.00 (0.118)	7.00 (0.276)	18.0 (0.709)
121J	12.5 (0.492)	12.5 (0.492)	8.00 (0.315)	5.00 (0.197)	2.00 (0.079)	7.60 (0.299)	10.00 (0.394)	6.00 (0.236)	3.00 (0.118)	7.00 (0.276)	18.0 (0.709)

HOW TO ORDER

LM	XS	1212	M	R04	H	T	A	S
Family	Series	Size	Tolerance	Inductance	Style	Termination	Special	Packaging
LM = Power Inductor	XS = Shielded	1212 = 12x12xh 121G = 12x12xG(h) (h = see catalog)	M = $\pm 20\%$	3R9 = 3.900 μ H 390 = 39.00 μ H 391 = 390 μ H 102 = 1000 μ H		T = Sn Plate	A = Standard	S = 13" Reel

LMax SMD Power Inductor



LMXS Series – Shielded Style H

ELECTRICAL CHARACTERISTICS

1212

Codes	L (μH)	Tolerance	Test Condition	DCR (Ω) max.	IDC (A) max.
3R9	3.9	M	100KHz, 1.0V	0.015	6.50
4R7	4.7	M	100KHz, 1.0V	0.018	5.70
6R8	6.8	M	100KHz, 1.0V	0.023	4.90
100	10	M	100KHz, 1.0V	0.028	4.50
120	12	M	100KHz, 1.0V	0.038	4.00
150	15	M	100KHz, 1.0V	0.050	3.20
180	18	M	100KHz, 1.0V	0.057	3.10
220	22	M	100KHz, 1.0V	0.066	2.90
270	27	M	100KHz, 1.0V	0.080	2.80
330	33	M	100KHz, 1.0V	0.097	2.70
390	39	M	100KHz, 1.0V	0.132	2.10
470	47	M	100KHz, 1.0V	0.150	1.90
560	56	M	100KHz, 1.0V	0.190	1.80
680	68	M	100KHz, 1.0V	0.220	1.50
820	82	M	100KHz, 1.0V	0.260	1.30
101	100	M	100KHz, 1.0V	0.308	1.20
121	120	M	100KHz, 1.0V	0.380	1.10
151	150	M	100KHz, 1.0V	0.530	0.95
181	180	M	100KHz, 1.0V	0.620	0.85
221	220	M	100KHz, 1.0V	0.700	0.80
271	270	M	100KHz, 1.0V	0.876	0.60
331	330	M	100KHz, 1.0V	0.990	0.50

121G

Codes	L (μH)	Tolerance	Test Condition	DCR (Ω) max.	IDC (A) max.
100	10	M	100KHz, 1.0V	0.025	4.00
120	12	M	100KHz, 1.0V	0.027	3.50
150	15	M	100KHz, 1.0V	0.030	3.30
180	18	M	100KHz, 1.0V	0.038	3.00
220	22	M	100KHz, 1.0V	0.045	2.80
270	27	M	100KHz, 1.0V	0.055	2.30
330	33	M	100KHz, 1.0V	0.063	2.10
390	39	M	100KHz, 1.0V	0.075	2.00
470	47	M	100KHz, 1.0V	0.085	1.80
560	56	M	100KHz, 1.0V	0.110	1.70
680	68	M	100KHz, 1.0V	0.120	1.50
820	82	M	100KHz, 1.0V	0.140	1.040
101	100	M	100KHz, 1.0V	0.165	1.30
121	120	M	100KHz, 1.0V	0.195	1.10
151	150	M	100KHz, 1.0V	0.250	1.00
181	180	M	100KHz, 1.0V	0.290	0.90
221	220	M	100KHz, 1.0V	0.0400	0.80
271	270	M	100KHz, 1.0V	0.0460	0.75
331	330	M	100KHz, 1.0V	0.510	0.68
391	390	M	100KHz, 1.0V	0.690	0.65
471	470	M	100KHz, 1.0V	0.770	0.58
561	560	M	100KHz, 1.0V	0.880	0.54
681	680	M	100KHz, 1.0V	1.200	0.048
582	820	M	100KHz, 1.0V	1.340	0.043
102	1000	M	100KHz, 1.0V	1.530	0.040

LMax SMD Power Inductor



LMXS Series – Shielded Style H

121J

Codes	L (μ H)	Tolerance	Test Condition	DCR (Ω) max.	IDC (A) max.
2R4	2.4	M	100KHz, 1.0V	0.012	8.00
4R7	4.7	M	100KHz, 1.0V	0.016	6.80
7R6	7.6	M	100KHz, 1.0V	0.020	5.90
100	10	M	100KHz, 1.0V	0.022	5.40
120	12	M	100KHz, 1.0V	0.025	4.90
150	15	M	100KHz, 1.0V	0.027	4.50
180	18	M	100KHz, 1.0V	0.039	3.90
220	22	M	100KHz, 1.0V	0.043	3.60
270	27	M	100KHz, 1.0V	0.046	3.40
330	33	M	100KHz, 1.0V	0.065	3.00
390	39	M	100KHz, 1.0V	0.073	2.75
470	47	M	100KHz, 1.0V	0.100	2.50

LMax SMD Power Inductor



LMXS Series – Shielded Style J

FEATURES

- Directly connected electrode on ferrite core
- High power, High saturation inductors
- Ideal inductors for DC/DC converters
- Magnetically shielded against radiation
- Available on tape and reel for automatic surface mounting

APPLICATIONS

- Power Supply for VTRs
- LCD Televisions
- Notebook PCs
- Portable Communication
- DC/DC Converters, etc.

CHARACTERISTICS

- Rated DC current: The current when the inductance becomes 35% lower than its initial value or the actual current when the temperature of coil increases to $\Delta T=40^{\circ}\text{C}$. The smaller one is defined as Rated DC Current. ($T_a=25^{\circ}\text{C}$)
- Operating temperature range: $-40 \sim 85^{\circ}\text{C}$

INDUCTANCE AND RATED CURRENT RANGES

- 0606 2.5 ~ 100 μH 2.60 ~ 0.40A
- 1010 10 ~ 150 μH 2.70 ~ 0.70A
- 101D 1.3 ~ 330 μH 10.0 ~ 0.70A
- 101E 1.5 ~ 1000 μH 10.5 ~ 0.35A
- Electrical specifications at 25°C



DIMENSIONS

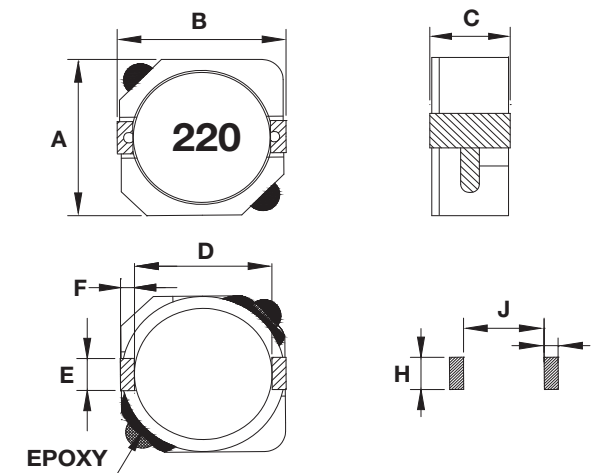

mm (inches)

Type	A max.	B max.	C max.	D	E	F	H	I	J
0606	6.20 (0.244)	6.30 (0.248)	3.00 (0.118)	4.70 (0.185)	2.00 (0.079)	0.60 (0.024)	2.60 (0.102)	1.00 (0.039)	4.60 (0.181)
1010	10.3 (0.406)	10.4 (0.409)	3.10 (0.122)	7.70 (0.303)	3.00 (0.118)	1.20 (0.047)	3.20 (0.126)	1.60 (0.063)	7.30 (0.287)
101D	10.3 (0.406)	10.4 (0.409)	4.00 (0.157)	7.70 (0.303)	3.00 (0.118)	1.20 (0.047)	3.20 (0.126)	1.60 (0.063)	7.30 (0.287)
101E	10.3 (0.406)	10.4 (0.409)	5.00 (0.197)	7.70 (0.303)	3.00 (0.118)	1.20 (0.047)	3.20 (0.126)	1.60 (0.063)	7.30 (0.287)

HOW TO ORDER

LM	XS	0606	N	R04	J	T	A	S
Family	Series	Size	Tolerance	Inductance	Style	Termination	Special	Packaging
LM = Power Inductor	XS = Shielded	0606 = 6x6xh 1010 = 10x10xh 101D = 10x10xD(h) (h = see catalog)	N = $\pm 30\%$	R04 = 0.039 μH R39 = 0.390 μH 3R9 = 3.900 μH 390 = 39.00 μH 391 = 390.0 μH 392 = 3900 μH	J = Standard	T = Sn Plate	A = Standard	S = 13" Reel



LMax SMD Power Inductor



LMXS Series – Shielded Style J

0606/1010/101D/101E

Codes	L (μ H)	Tolerance	Test Condition	DCR (Ω) max.				IDC (A) max.			
				0606	1010	101D	101E	0606	1010	101D	101E
1R3	1.3	N	100KHz, 0.1V	–	–	8	–	–	–	10.0	–
1R5	1.5	N	100KHz, 0.1V	–	–	8	6	–	–	10.0	10.5
2R2	2.2	N	100KHz, 0.1V	–	–	11	7	–	–	8.00	9.25
2R5	2.5	N	100KHz, 0.1V	17.6	–	12	–	2.60	–	7.50	–
3R3	3.3	N	100KHz, 0.1V	20.3	–	13	10	2.30	–	6.50	7.80
3R8	3.8	N	100KHz, 0.1V	–	–	17	–	–	–	6.00	–
4R0	4.0	N	100KHz, 0.1V	27.0	–	–	–	2.10	–	–	–
4R7	4.7	N	100KHz, 0.1V	–	–	21	12	–	–	5.70	6.40
5R0	5.0	N	100KHz, 0.1V	31.1	–	–	–	1.85	–	–	–
5R2	5.2	N	100KHz, 0.1V	–	–	22	–	–	–	5.50	–
5R6	5.6	N	100KHz, 0.1V	–	–	25	–	–	–	5.20	–
6R0	6.0	N	100KHz, 0.1V	41.9	–	–	–	1.70	–	–	–
6R8	6.8	N	100KHz, 0.1V	–	–	26	18	–	–	4.90	5.40
7R0	7.0	N	100KHz, 0.1V	–	–	27	–	–	–	4.80	–
8R0	8.0	N	100KHz, 0.1V	49.9	–	–	–	1.50	–	–	–
8R2	8.2	N	100KHz, 0.1V	–	–	–	20	–	–	–	4.85
100	10	N	100KHz, 0.1V	54.0	58	35	26	1.30	2.70	4.40	3.45
120	12	N	100KHz, 0.1V	71.6	72	–	33	1.20	2.25	–	3.40
150	15	N	100KHz, 0.1V	82.4	86	50	41	1.10	2.22	3.60	2.83
180	18	N	100KHz, 0.1V	101.5	116	–	46	1.05	1.90	–	2.62
220	22	N	100KHz, 0.1V	119.0	145	73	61	0.95	1.78	2.90	2.44
270	27	N	100KHz, 0.1V	146.0	176	83	69	0.85	1.63	2.80	2.24
330	33	N	100KHz, 0.1V	182.5	213	93	84	0.76	1.46	2.30	1.88
390	39	N	100KHz, 0.1V	209.5	270	–	106	0.68	1.32	–	1.70
470	47	N	100KHz, 0.1V	229.5	299	128	130	0.60	1.18	2.10	1.56
560	56	N	100KHz, 0.1V	305.0	335	–	149	0.55	1.10	–	1.39
680	68	N	100KHz, 0.1V	351.0	451	213	201	0.48	1.04	1.50	1.36
820	82	N	100KHz, 0.1V	418.5	513	–	227	0.45	0.94	–	1.20
101	100	N	100KHz, 0.1V	520.0	700	304	253	0.40	0.84	1.35	1.09
121	120	N	100KHz, 0.1V	–	765	–	303	–	0.76	–	1.00
151	150	N	100KHz, 0.1V	–	876	506	370	–	0.70	1.15	0.91
181	180	N	100KHz, 0.1V	–	–	631	419	–	–	1.03	0.84
221	220	N	100KHz, 0.1V	–	–	756	500	–	–	0.92	0.75
271	270	N	100KHz, 0.1V	–	–	–	672	–	–	–	0.68
331	330	N	100KHz, 0.1V	–	–	1090	812	–	–	0.70	0.60
391	390	N	100KHz, 0.1V	–	–	–	953	–	–	–	0.57
471	470	N	100KHz, 0.1V	–	–	–	1289	–	–	–	0.50
561	560	N	100KHz, 0.1V	–	–	–	1430	–	–	–	0.47
681	680	N	100KHz, 0.1V	–	–	–	1599	–	–	–	0.43
821	820	N	100KHz, 0.1V	–	–	–	1768	–	–	–	0.39
102	1000	N	100KHz, 0.1V	–	–	–	1989	–	–	–	0.35

LMax SMD Power Inductor



LMXS Series – Shielded Style K

FEATURES

- Silver Plated Type, Low cost design
- High power, High saturation inductors
- Ideal inductors for DC/DC converters
- With magnetically shielded against radiation
- Available on tape and reel for automatic surface mounting

APPLICATIONS

- Power Supply for VTRs
- LCD Televisions
- Notebook PCs
- Portable Communication
- DC/DC Converters, etc.

CHARACTERISTICS

- Rated DC current: The current when the inductance becomes 25% lower than its initial value or the actual current when the temperature of coil increases to $\Delta 40^{\circ}\text{C}$. The smaller one is defined as Rated DC Current. ($T_a=25^{\circ}\text{C}$)
- Operating temperature range: $-40 \sim 85^{\circ}\text{C}$

INDUCTANCE AND RATED CURRENT RANGES

- 0606 10 ~ 68 μH 1.0 ~ 0.42A
- 0807 4.7 ~ 270 μH 3.15 ~ 0.33A
- 1009 10 ~ 470 μH 2.06 ~ 0.33A
- 1312 10 ~ 820 μH 2.65 ~ 0.36A
- Electrical specifications at 25°C



DIMENSIONS

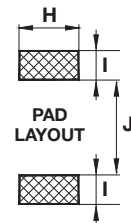
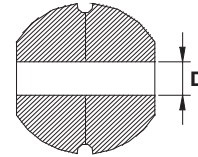
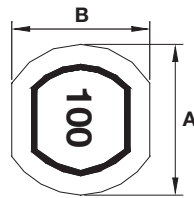

mm (inches)

Type	A	B	C	D	H	I	J
0606	6.20 ± 0.30 (0.244 ± 0.012)	5.60 ± 0.30 (0.220 ± 0.012)	3.20 ± 0.30 (0.126 ± 0.012)	1.70 (0.067)	5.50 (0.217)	2.25 (0.089)	1.70 (0.067)
0807	7.80 ± 0.35 (0.307 ± 0.014)	7.00 ± 0.35 (0.276 ± 0.014)	4.50 ± 0.40 (0.177 ± 0.016)	1.90 (0.075)	7.50 (0.295)	4.00 (0.157)	2.00 (0.079)
1009	10.0 ± 0.40 (0.394 ± 0.016)	9.00 ± 0.40 (0.354 ± 0.016)	5.00 ± 0.50 (0.197 ± 0.020)	2.50 (0.098)	9.50 (0.374)	5.00 (0.197)	2.50 (0.098)
1312	12.6 ± 0.50 (0.496 ± 0.020)	11.6 ± 0.50 (0.457 ± 0.020)	5.40 ± 0.50 (0.213 ± 0.020)	3.00 (0.118)	12.0 (0.472)	6.00 (0.236)	3.00 (0.118)

HOW TO ORDER

LM	XS	0606	M	R04	K	T	A	S
Family	Series	Size	Tolerance	Inductance	Style	Termination	Special	Packaging
LM = Power Inductor	XS = Shielded	0606 = 6x6xh 1312 = 13x12xh (h = see catalog)	M = ±20% N = ±30%	3R9 = 3.900 μH 390 = 39.00 μH 391 = 390.0 μH 392 = 3900 μH		T = Sn Plate	A = Standard	S = 13" Reel

LMax SMD Power Inductor



LMXS Series – Shielded Style K

ELECTRICAL CHARACTERISTICS

0606/0807/1009/1312

Codes	L (μ H)	Tolerance	Test Condition	DCR (Ω) max.				IDC (A) max.			
				0606	0807	1009	1312	0606	0807	1009	1312
4R7	4.7	N	100KHz, 0.25V	–	0.03	–	–	–	3.15	–	–
100	10	M	2.52MHz, 0.25V	0.14	0.07	0.06	0.05	1.00	1.65	2.06	2.65
120	12	M	2.52MHz, 0.25V	0.16	0.07	0.07	0.05	0.94	1.57	1.94	2.50
150	15	M	2.52MHz, 0.25V	0.18	0.08	0.07	0.06	0.86	1.39	1.72	2.45
180	18	M	2.52MHz, 0.25V	0.25	0.10	0.08	0.06	0.78	1.29	1.58	2.40
220	22	M	2.52MHz, 0.25V	0.32	0.13	0.08	0.07	0.76	1.12	1.42	2.20
270	27	M	2.52MHz, 0.25V	0.36	0.16	0.10	0.08	0.64	1.06	1.32	2.00
330	33	M	2.52MHz, 0.25V	0.41	0.18	0.11	0.10	0.61	0.97	1.16	1.80
390	39	M	2.52MHz, 0.25V	0.47	0.18	0.12	0.11	0.53	0.91	1.10	1.65
470	47	M	2.52MHz, 0.25V	0.51	0.27	0.14	0.12	0.50	0.80	1.00	1.50
560	56	M	2.52MHz, 0.25V	0.72	0.29	0.19	0.15	0.46	0.76	0.93	1.38
680	68	M	2.52MHz, 0.25V	0.82	0.33	0.21	0.17	0.42	0.68	0.85	1.26
820	82	M	2.52MHz, 0.25V	–	0.43	0.28	0.20	–	0.62	0.79	1.14
101	100	M	1KHz, 0.25V	–	0.49	0.34	0.25	–	0.55	0.72	1.05
121	120	M	1KHz, 0.25V	–	0.68	0.37	0.28	–	0.49	0.63	0.95
151	150	M	1KHz, 0.25V	–	0.94	0.51	0.40	–	0.44	0.55	0.85
181	180	M	1KHz, 0.25V	–	1.00	0.57	0.48	–	0.40	0.50	0.77
221	220	M	1KHz, 0.25V	–	1.18	0.78	0.52	–	0.36	0.47	0.70
271	270	M	1KHz, 0.25V	–	1.30	0.87	0.70	–	0.33	0.41	0.63
331	330	M	1KHz, 0.25V	–	–	1.20	0.80	–	–	0.37	0.57
391	390	M	1KHz, 0.25V	–	–	1.34	1.08	–	–	0.35	0.52
471	470	M	1KHz, 0.25V	–	–	1.50	1.20	–	–	0.33	0.48
561	560	M	1KHz, 0.25V	–	–	–	1.34	–	–	–	0.44
681	680	M	1KHz, 0.25V	–	–	–	1.78	–	–	–	0.40
821	820	M	1KHz, 0.25V	–	–	–	2.00	–	–	–	0.36

LMax SMD Power Inductor



LMXS Series – Shielded Style L

FEATURES

- Magnetically Shielded Construction
- Large Current
- Low DCR

APPLICATIONS

- LCD Televisions
- Notebooks
- Camcorders
- Digital Cameras
- DC/DC Converters for Portable Devices

CHARACTERISTICS

- Rated Current (IDC): The DC current that will cause an approximate ΔT of 40°C. (Ta=25°C)
- Operating temperature range: -40°C ~ +125°C

INDUCTANCE AND RATED CURRENT RANGES

- 1010 0.8uH ~ 47.0uH 11.2 ~ 1.43A
- 101D 1.5uH ~ 330uH 10.0 ~ 0.70A
- Electrical specifications at 25°C



DIMENSIONS

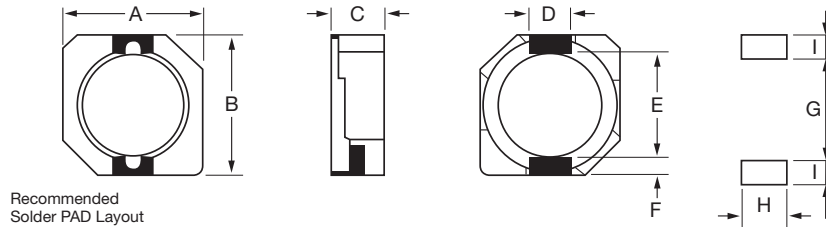

mm (inches)

Type	A max	B max	C max	D	E	F	G	H	I
1010	10.3 (0.398)	10.5 (0.414)	3.10 (0.122)	3.00 ± 0.10 (0.119 ± 0.004)	7.70 ± 0.30 (0.303 ± 0.012)	1.20 ± 0.150 (0.048 ± 0.006)	7.30 (0.288)	3.20 (0.126)	1.60 (0.630)
101D	10.3 (0.398)	10.5 (0.414)	3.80 ± 0.20 (0.150 ± 0.008)	3.00 ± 0.1 (0.119 ± 0.004)	7.70 ± 0.30 (0.303 ± 0.012)	1.2 ± 0.15 (0.048 ± 0.006)	7.30 (0.288)	3.20 (0.126)	1.60 (0.630)

HOW TO ORDER

LM	XS	1010	N	2R2	L	T	A	S
Family	Series	Size	Tolerance	Inductance	Style	Termination	Special	Packaging
LM = Power Inductor	XS = Shielded	1010 = 10x10xh 101D = 10x10xD(h) (h = see catalog)	N = ±30%	0R8 = 0.8µH 470 = 47.00µH 331 = 330.0µH		T = Sn Plate	A = Standard	S = 13" Reel

LMax SMD Power Inductor



LMXS Series – Shielded Style L

ELECTRICAL CHARACTERISTICS

1010

Codes	L (μH)	Tolerance	Test Condition	DCR (Ω) max.	IDC (A) max.
0R8	0.8	N	100KHz, 1.0V	0.0057	11.2
1R5	1.5	N	100KHz, 1.0V	0.011	8.00
2R2	2.2	N	100KHz, 1.0V	0.0159	6.70
3R3	3.3	N	100KHz, 1.0V	0.021	5.56
4R7	4.7	N	100KHz, 1.0V	0.030	4.55
6R8	6.8	N	100KHz, 1.0V	0.035	3.84
8R0	8.0	N	100KHz, 1.0V	0.050	3.54
100	10	N	100KHz, 1.0V	0.059	3.18
150	15	N	100KHz, 1.0V	0.091	2.60
220	22	N	100KHz, 1.0V	0.143	2.16
330	33	N	100KHz, 1.0V	0.202	1.74
470	47	N	100KHz, 1.0V	0.299	1.43

101D

Codes	L (μH)	Tolerance	Test Condition	DCR (Ω) max.	IDC (A) max.
1R5	1.5	N	100KHz, 1.0V	0.0081	10.0
2R5	2.5	N	100KHz, 1.0V	0.010	7.50
3R8	3.8	N	100KHz, 1.0V	0.013	6.00
4R7	4.7	N	100KHz, 1.0V	0.022	5.50
5R2	5.2	N	100KHz, 1.0V	0.022	5.50
7R0	7.0	N	100KHz, 1.0V	0.027	4.80
100	10	N	100KHz, 1.0V	0.035	4.40
150	15	N	100KHz, 1.0V	0.050	3.60
220	22	N	100KHz, 1.0V	0.073	2.90
330	33	N	100KHz, 1.0V	0.093	2.30
470	47	N	100KHz, 1.0V	0.128	2.10
680	68	N	100KHz, 1.0V	0.213	1.50
101	100	N	100KHz, 1.0V	0.304	1.35
151	150	N	100KHz, 1.0V	0.506	1.15
221	220	N	100KHz, 1.0V	0.756	0.92
331	330	N	100KHz, 1.0V	1.090	0.70

LMax SMD Power Inductor



LMXS Series – Shielded Style M

FEATURES

- Magnetically shielded construction
- RoHS compliance

APPLICATIONS

- LCD TV
- DC to DC Converters
- Notebook PC

CHARACTERISTICS

- Rated DC Current: The current when the inductance becomes 35% lower than its initial value.
- Operating temperature: -40 ~ 85°C

INDUCTANCE AND RATED CURRENT RANGES

- 0808 1.0 ~ 100µH 6.5 ~ 0.75A
- 08D8 1.8 ~ 100µH 7.0 ~ 1.05A
- 08E8 1.0 ~ 100µH 9.0 ~ 1.30A
- Electrical specifications at 25°C



DIMENSIONS

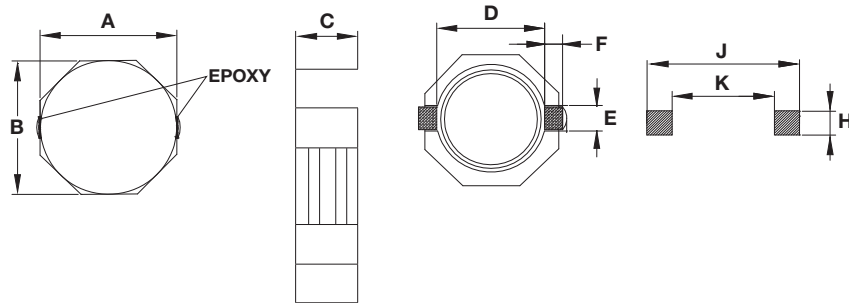

mm (inches)

Type	A	B	C max.	D Ref.	E Ref.	F Ref.	H	J	K
0808	8.00 ± 0.30 (0.315 ± 0.012)	8.00 ± 0.30 (0.315 ± 0.012)	3.00 (0.118)	6.30 (0.248)	2.50 (0.098)	1.20 (0.047)	2.80 (0.110)	10.1 (0.398)	6.10 (0.240)
08D8	8.00 ± 0.30 (0.315 ± 0.012)	8.00 ± 0.30 (0.315 ± 0.012)	4.00 (0.157)	6.30 (0.248)	2.50 (0.098)	1.20 (0.047)	2.80 (0.110)	10.1 (0.398)	6.10 (0.240)
08E8	8.0 ± 0.30 (0.315 ± 0.012)	8.00 ± 0.30 (0.315 ± 0.012)	4.50 (0.177)	6.30 (0.248)	2.50 (0.098)	1.20 (0.047)	2.80 (0.110)	10.1 (0.398)	6.10 (0.240)

HOW TO ORDER

LM



Family

LM = Power Inductor

XS



Series

XN = Non-shielded

0808



Size

0808 = 8x8xh
08D8 = 8x8xD(h)
(h = see catalog)

N



Tolerance

N = ±30%

R04



Inductance

3R9 = 3.900µH
390 = 39.00µH
391 = 390.0µH
392 = 3900µH

M



Style

T



Termination

T = Sn Plate

A



Special

A = Standard

S



Packaging

S = 13" Reel

LMax SMD Power Inductor



LMXS Series – Shielded Style M

ELECTRICAL CHARACTERISTICS

0808/08D8/08E8

Codes	L (μ H)	Tolerance	Test Condition		DCR (Ω) max.			I sat (A) max*		
			0808	08D8/08E8	0808	08D8	08E8	0808	08D8	0838
1R0	1.0	N	100KHz, 0.25V	100KHz, 0.1V	11.0	–	9.50	6.5	–	9.0
1R2	1.2	N	100KHz, 0.25V	100KHz, 0.1V	–	–	12.2	–	–	8.0
1R8	1.8	N	100KHz, 0.25V	100KHz, 0.1V	–	15.6	–	–	7.0	–
2R0	2.0	N	100KHz, 0.25V	100KHz, 0.1V	–	–	14.0	–	–	7.0
2R5	2.5	N	100KHz, 0.25V	100KHz, 0.1V	15.6	17.5	–	4.5	6.5	–
3R3	3.3	N	100KHz, 0.25V	100KHz, 0.1V	18.2	–	–	4.0	–	–
3R5	3.5	N	100KHz, 0.25V	100KHz, 0.1V	–	24.0	–	–	5.0	–
3R9	3.9	N	100KHz, 0.25V	100KHz, 0.1V	–	–	19.0	–	–	5.9
4R7	4.7	N	100KHz, 0.25V	100KHz, 0.1V	24.7	29.0	22.0	3.4	4.6	5.6
6R0	6.0	N	100KHz, 0.25V	100KHz, 0.1V	–	32.0	–	–	4.2	–
6R8	6.8	N	100KHz, 0.25V	100KHz, 0.1V	–	–	25.0	–	–	4.4
7R3	7.3	N	100KHz, 0.25V	100KHz, 0.1V	39.0	–	–	2.80	–	–
100	10	N	100KHz, 0.25V	100KHz, 0.1V	47.0	48.0	36.0	2.50	3.00	4.0
150	15	N	100KHz, 0.25V	100KHz, 0.1V	69.0	67.0	53.0	1.90	2.75	2.9
220	22	N	100KHz, 0.25V	100KHz, 0.1V	99.0	105	75.0	1.60	2.30	2.6
330	33	N	100KHz, 0.25V	100KHz, 0.1V	156	157	125	1.30	1.75	2.2
470	47	N	100KHz, 0.25V	100KHz, 0.1V	195	189	150	1.15	1.52	1.8
680	68	N	100KHz, 0.25V	100KHz, 0.1V	286	290	240	0.92	1.30	1.5
101	100	N	100KHz, 0.25V	100KHz, 0.1V	430	410	360	0.75	1.05	1.3

*Saturation Current: The current when the inductance becomes 35% lower than its initial value.

LMax SMD Power Inductor



LMXS Series – Shielded Style P

FEATURES

- Magnetically Shielded Construction
- Large Current
- Low DCR

APPLICATIONS

- LCD Televisions
- Notebooks
- Camcorders
- Digital Cameras
- DC/DC Converters for Portable Devices

CHARACTERISTICS

- Rated Current (IDC): The DC current that will cause an approximate ΔT of 40°C. ($T_a=25^\circ\text{C}$)
- Operating temperature range: $-40^\circ\text{C} \sim +125^\circ\text{C}$

INDUCTANCE AND RATED CURRENT RANGES

- 0404 1.5 ~ 33 μH 1.55 ~ 0.32A
- 0505 1.0~ 39 μH 1.72 ~ 0.30A
- 05C5 1.2 ~ 180 μH 2.56 ~ 0.22A
- 0606 4.1 ~ 100 μH 1.95 ~ 0.36A
- 06C6 2.6 ~ 100 μH 2.6 ~ 0.42A
- 0707 3.3 ~ 10 μH 3.00 ~ 1.8A
- 07C7 3.0 ~ 100 μH 3.00 ~ 0.54A
- 07D7 3.3 ~ 100 μH 3.50 ~ 0.65A
- Electrical specifications at 25°C



DIMENSIONS

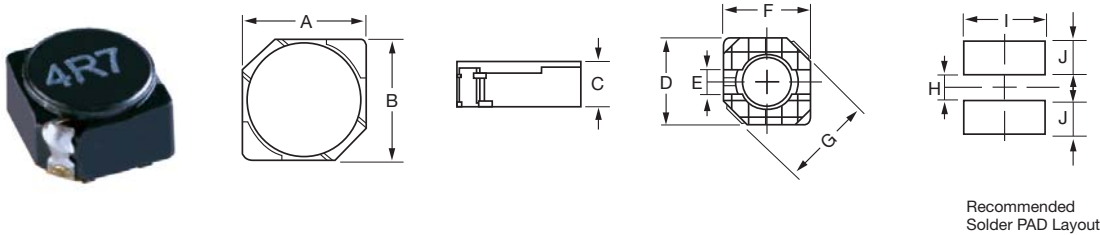

Type	A	B max	C max	D	E	F max	G max	H	I
0404	3.80 ± 0.50 (0.150 ± 0.012)	3.80 ± 0.50 (0.150 ± 0.012)	1.80 ± 0.20 (0.071 ± .008)	3.80 (0.150)	1.10 (0.044)	3.80 (0.150)	5.00 (0.196)	1.10 (0.044)	4.60 (0.181)
0505	4.70 ± 0.50 (0.185 ± 0.012)	4.70 ± 0.50 (0.185 ± 0.012)	2.00 (0.079)	4.50 (0.177)	1.50 (0.059)	4.50 (0.177)	6.90 (0.272)	1.50 (0.059)	5.30 (0.209)
05C5	4.70 ± 0.50 (0.185 ± 0.012)	4.70 ± 0.50 (0.185 ± 0.012)	3.00 (0.119)	4.50 (0.177)	1.50 (0.059)	4.50 (0.177)	6.90 (0.272)	1.50 (0.059)	5.30 (0.209)
0606	5.7 ± 0.50 (0.225 ± 0.012)	5.70 ± 0.50 (0.225 ± 0.012)	2.10 (0.083)	5.50 (0.217)	2.00 (0.079)	5.50 (0.217)	8.20 (0.323)	2.00 (0.079)	6.30 (0.248)
06C6	5.70 ± 0.50 (0.225 ± 0.012)	5.70 ± 0.50 (0.225 ± 0.012)	3.00 (0.119)	5.50 (0.217)	2.00 (0.079)	5.50 (0.217)	8.20 (0.323)	2.00 (0.079)	6.30 (0.248)
0707	6.70 ± 0.40 (0.264 ± 0.158)	6.70 ± 0.40 (0.264 ± 0.158)	1.90 (0.075)	6.50 (0.256)	2.00 (0.079)	6.50 (0.256)	9.50 (0.375)	2.00 (0.079)	7.30 (0.288)
07C7	6.70 ± 0.50 (0.264 ± 0.012)	6.70 ± 0.50 (0.264 ± 0.012)	3.00 (0.119)	6.50 (0.256)	2.00 (0.079)	6.50 (0.256)	9.50 (0.375)	2.00 (0.079)	7.30 (0.288)
07D7	6.70 ± 0.50 (0.264 ± 0.012)	6.70 ± 0.50 (0.264 ± 0.012)	4.00 (0.158)	6.50 (0.256)	2.00 (0.079)	6.50 (0.256)	9.50 (0.375)	2.00 (0.079)	7.30 (0.288)

HOW TO ORDER

LM	XS	0505	M	2R2	P	T	A	S
Family	Series	Size	Tolerance	Inductance	Style	Termination	Special	Packaging
LM = Power Inductor	XS = Shielded	0505 = 5x5xh 05C5 = 5x5xC(h) (h = see catalog)	M = ±20%	0R8 = 0.8 μH 470 = 47.00 μH 331 = 330.0 μH		T = Sn Plate	A = Standard	S = 13" Reel



LMax SMD Power Inductor



LMXS Series – Shielded Style P

ELECTRICAL CHARACTERISTICS

0404

Codes	L (μH)	Tolerance	Test Condition	DCR (Ω) max.	IDC (A) max.
1R5	1.5	M	100KHz, 1.0V	0.052	1.55
2R2	2.2	M	100KHz, 1.0V	0.072	1.20
3R3	3.3	M	100KHz, 1.0V	0.085	1.10
4R7	4.7	M	100KHz, 1.0V	0.105	0.90
6R8	6.8	M	100KHz, 1.0V	0.170	0.73
100	10	M	100KHz, 1.0V	0.210	0.55
150	15	M	100KHz, 1.0V	0.295	0.45
220	22	M	100KHz, 1.0V	0.430	0.40
330	33	M	100KHz, 1.0V	0.675	0.32

0505

Codes	L (μH)	Tolerance	Test Condition	DCR (Ω) max.	IDC (A) max.
1R0	1.0	M	100KHz, 1.0V	0.045	1.72
2R2	2.2	M	100KHz, 1.0V	0.060	1.32
2R7	2.7	M	100KHz, 1.0V	0.070	1.28
3R3	3.3	M	100KHz, 1.0V	0.085	1.04
3R9	3.9	M	100KHz, 1.0V	0.110	0.88
4R7	4.7	M	100KHz, 1.0V	0.128	0.84
5R6	5.6	M	100KHz, 1.0V	0.145	0.80
6R8	6.8	M	100KHz, 1.0V	0.158	0.76
8R2	8.2	M	100KHz, 1.0V	0.185	0.68
100	10	M	100KHz, 1.0V	0.200	0.61
120	12	M	100KHz, 1.0V	0.210	0.56
150	15	M	100KHz, 1.0V	0.240	0.50
180	18	M	100KHz, 1.0V	0.338	0.48
220	22	M	100KHz, 1.0V	0.397	0.41
270	27	M	100KHz, 1.0V	0.441	0.35
330	33	M	100KHz, 1.0V	0.694	0.32
390	39	M	100KHz, 1.0V	0.709	0.30

05C5

Codes	L (μH)	Tolerance	Test Condition	DCR (Ω) max.	IDC (A) max.
1R2	1.2	M	100KHz, 1.0V	0.0236	2.56
1R8	1.8	M	100KHz, 1.0V	0.0275	2.20
2R2	2.2	M	100KHz, 1.0V	0.0313	2.04
2R7	2.7	M	100KHz, 1.0V	0.0433	1.60
3R3	3.3	M	100KHz, 1.0V	0.0492	1.57
3R9	3.9	M	100KHz, 1.0V	0.0648	1.44
4R7	4.7	M	100KHz, 1.0V	0.0720	1.32
5R6	5.6	M	100KHz, 1.0V	0.1009	1.17
6R8	6.8	M	100KHz, 1.0V	0.1089	1.12
8R2	8.2	M	100KHz, 1.0V	0.1175	1.04
100	10	M	100KHz, 1.0V	0.1283	1.00
120	12	M	100KHz, 1.0V	0.1316	0.84
150	15	M	100KHz, 1.0V	0.1490	0.76
180	18	M	100KHz, 1.0V	0.1660	0.72
220	22	M	100KHz, 1.0V	0.2350	0.70
270	27	M	100KHz, 1.0V	0.2610	0.58
330	33	M	100KHz, 1.0V	0.3780	0.56
390	39	M	100KHz, 1.0V	0.3837	0.50
470	47	M	100KHz, 1.0V	0.5870	0.48
560	56	M	100KHz, 1.0V	0.6245	0.41
680	68	M	100KHz, 1.0V	0.6990	0.35
820	82	M	100KHz, 1.0V	0.9148	0.32
101	100	M	100KHz, 1.0V	1.020	0.29
121	120	M	100KHz, 1.0V	1.270	0.27
151	150	M	100KHz, 1.0V	1.350	0.24
181	180	M	100KHz, 1.0V	1.540	0.22

LMax SMD Power Inductor



LMXS Series – Shielded Style P

0606

Codes	L (µH)	Tolerance	Test Condition	DCR (Ω) max.	IDC (A) max.
4R1	4.1	M	100KHz, 1.0V	0.057	1.95
5R4	5.4	M	100KHz, 1.0V	0.076	1.6
6R2	6.2	M	100KHz, 1.0V	0.096	1.4
8R9	8.9	M	100KHz, 1.0V	0.116	1.25
100	10	M	100KHz, 1.0V	0.124	1.2
120	12	M	100KHz, 1.0V	0.153	1.1
150	15	M	100KHz, 1.0V	0.196	0.97
180	18	M	100KHz, 1.0V	0.21	0.85
220	22	M	100KHz, 1.0V	0.29	0.8
270	27	M	100KHz, 1.0V	0.33	0.75
330	33	M	100KHz, 1.0V	0.386	0.65
390	39	M	100KHz, 1.0V	0.52	0.57
470	47	M	100KHz, 1.0V	0.595	0.54
560	56	M	100KHz, 1.0V	0.665	0.5
680	68	M	100KHz, 1.0V	0.84	0.43
820	82	M	100KHz, 1.0V	0.978	0.41
101	100	M	100KHz, 1.0V	1.2	0.36

06C6

Codes	L (µH)	Tolerance	Test Condition	DCR (Ω) max.	IDC (A) max.
2R6	2.6	M	100KHz, 1.0V	0.018	2.6
3R0	3	M	100KHz, 1.0V	0.024	2.4
4R2	4.2	M	100KHz, 1.0V	0.031	2.2
5R3	5.3	M	100KHz, 1.0V	0.038	1.9
6R2	6.2	M	100KHz, 1.0V	0.045	1.8
8R2	8.2	M	100KHz, 1.0V	0.053	1.6
100	10	M	100KHz, 1.0V	0.065	1.3
120	12	M	100KHz, 1.0V	0.076	1.2
150	15	M	100KHz, 1.0V	0.103	1.1
180	18	M	100KHz, 1.0V	0.11	1
220	22	M	100KHz, 1.0V	0.122	0.9
270	27	M	100KHz, 1.0V	0.175	0.85
330	33	M	100KHz, 1.0V	0.189	0.75
390	39	M	100KHz, 1.0V	0.212	0.7
470	47	M	100KHz, 1.0V	0.26	0.62
560	56	M	100KHz, 1.0V	0.305	0.58
680	68	M	100KHz, 1.0V	0.355	0.52
820	82	M	100KHz, 1.0V	0.463	0.46
101	100	M	100KHz, 1.0V	0.52	0.42

LMax SMD Power Inductor



LMXS Series – Shielded Style P

0707

Codes	L (μH)	Tolerance	Test Condition	DCR (Ω) max.	IDC (A) max.
3R3	3.3	M	100KHz, 1.0V	0.069	3
4R7	4.7	M	100KHz, 1.0V	0.075	2.4
6R8	6.8	M	100KHz, 1.0V	0.106	2.2
100	10	M	100KHz, 1.0V	0.15	1.8

07C7

Codes	L (μH)	Tolerance	Test Condition	DCR (Ω) max.	IDC (A) max.
3R0	3	M	100KHz, 1.0V	0.024	3
3R9	3.9	M	100KHz, 1.0V	0.027	2.6
5R0	5	M	100KHz, 1.0V	0.031	2.4
6R0	6	M	100KHz, 1.0V	0.035	2.25
7R3	7.3	M	100KHz, 1.0V	0.054	2.1
8R6	8.6	M	100KHz, 1.0V	0.058	1.85
100	10	M	100KHz, 1.0V	0.065	1.7
120	12	M	100KHz, 1.0V	0.07	1.55
150	15	M	100KHz, 1.0V	0.084	1.4
180	18	M	100KHz, 1.0V	0.095	1.32
220	22	M	100KHz, 1.0V	0.128	1.2
270	27	M	100KHz, 1.0V	0.142	1.05
330	33	M	100KHz, 1.0V	0.165	0.97
390	39	M	100KHz, 1.0V	0.21	0.86
470	47	M	100KHz, 1.0V	0.238	0.8
560	56	M	100KHz, 1.0V	0.277	0.73
680	68	M	100KHz, 1.0V	0.304	0.65
820	82	M	100KHz, 1.0V	0.39	0.6
101	100	M	100KHz, 1.0V	0.535	0.54

07D7

Codes	L (μH)	Tolerance	Test Condition	DCR (Ω) max.	IDC (A) max.
3R3	3.3	M	100KHz, 1.0V	0.02	3.5
5R0	5	M	100KHz, 1.0V	0.024	2.9
6R0	6	M	100KHz, 1.0V	0.027	2.5
7R3	7.3	M	100KHz, 1.0V	0.031	2.3
8R6	8.6	M	100KHz, 1.0V	0.034	2.2
100	10	M	100KHz, 1.0V	0.038	2
120	12	M	100KHz, 1.0V	0.053	1.7
150	15	M	100KHz, 1.0V	0.057	1.6
180	18	M	100KHz, 1.0V	0.092	1.5
220	22	M	100KHz, 1.0V	0.096	1.3
270	27	M	100KHz, 1.0V	0.109	1.2
330	33	M	100KHz, 1.0V	0.124	1.1
390	39	M	100KHz, 1.0V	0.138	1
470	47	M	100KHz, 1.0V	0.155	0.95
560	56	M	100KHz, 1.0V	0.202	0.85
680	68	M	100KHz, 1.0V	0.234	0.75
820	82	M	100KHz, 1.0V	0.324	0.7
101	100	M	100KHz, 1.0V	0.358	0.65

LMax SMD Power Inductor



LMXS Series – Shielded Style Q, S

FEATURES

- Magnetically Shielded Construction
- Large Current
- Low DCR

APPLICATIONS

- LCD Televisions
- Notebooks
- PDAs
- Digital Cameras
- Handheld Communication
- DC/DC Converters, etc.

CHARACTERISTICS

- Rated Current (IDC): The DC current that will cause an approximate ΔT of 40°C. ($T_a=25^\circ\text{C}$)
- Operating temperature range: $-40^\circ\text{C} \sim +125^\circ\text{C}$

INDUCTANCE AND RATED CURRENT RANGES

- 0707 3.3 μH ~ 47 μH 1.68 ~ 0.16A
- 07C7 2.2 μH ~ 68 μH 1.84 ~ 0.18A
- 1010 2.7 μH ~ 33 μH 3.40 ~ 0.80A
- 101B 3.9 μH ~ 33 μH 3.80 ~ 1.20A
- Electrical specifications at 25°C



DIMENSIONS

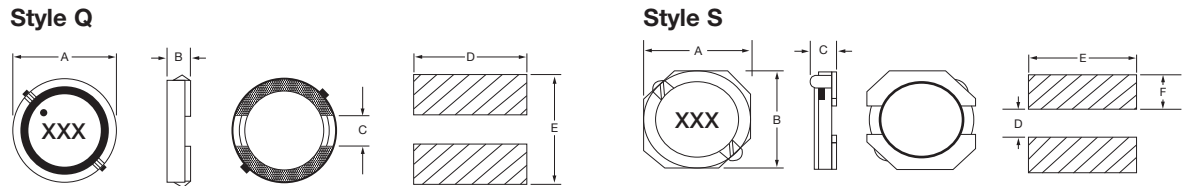

mm (inches)

Type	Style	A max	B max	C max	D	E	F
0707	Q	6.90 ± 0.40 (0.271 ± 0.157)	1.50 (0.059)	2.00 (0.079)	7.30 (0.288)	7.30 (0.288)	–
07C7	Q	7.00 ± 0.50 (0.276 ± 0.020)	2.80 (0.110)	2.00 (0.079)	7.30 (0.288)	7.30 (0.288)	–
1010	S	10.3 (0.406)	10.3 (0.406)	1.50 (0.059)	3.00 (0.119)	10.4 (0.410)	3.70 (0.146)
101B	S	10.3 (0.406)	10.3 (0.406)	2.50 (0.099)	3.0 (0.119)	10.4 (0.410)	3.70 (0.146)

HOW TO ORDER

LM	XS	0707	M	2R2	Q	T	A	S
Family	Series	Size	Tolerance	Inductance	Style	Termination	Special	Packaging
LM = Power Inductor	XS = Shielded	0707 = 7x7xh 07C7 = 7x7xC(h) (h = see catalog)	T = ±25%	2R2 = 2.20 μH 680 = 68.00 μH	Q Q S	T = Sn Plate	A = Standard	S = 13" Reel

LMax SMD Power Inductor



LMXS Series – Shielded Style Q, S

ELECTRICAL CHARACTERISTICS

0707

Codes	L (μH)	Tolerance	Test Condition	DCR (Ω) max.	IDC (A) max.
3R3	3.3	T	100KHz, 1.0V	0.085	2.10
4R7	4.7	T	100KHz, 1.0V	0.115	1.70
6R8	6.8	T	100KHz, 1.0V	0.144	1.45
100	10	T	100KHz, 1.0V	0.225	1.25
150	15	T	100KHz, 1.0V	0.290	1.05
220	22	T	100KHz, 1.0V	0.450	0.85
470	47	T	100KHz, 1.0V	0.850	0.55

07C7

Codes	L (μH)	Tolerance	Test Condition	DCR (Ω) max.	IDC (A) max.
2R2	2.2	T	100KHz, 1.0V	0.028	4.00
2R7	2.7	T	100KHz, 1.0V	0.030	3.60
3R3	3.3	T	100KHz, 1.0V	0.035	3.20
4R7	4.7	T	100KHz, 1.0V	0.045	2.60
6R8	6.8	T	100KHz, 1.0V	0.058	2.20
100	10	T	100KHz, 1.0V	0.075	1.80
220	22	T	100KHz, 1.0V	0.180	1.20
470	47	T	100KHz, 1.0V	0.390	0.90
680	68	T	100KHz, 1.0V	0.510	0.80

1010

Codes	L (μH)	Tolerance	Test Condition	DCR (Ω) max.	IDC (A) max.
2R7	2.7	T	100KHz, 1.0V	0.042	3.40
3R3	3.3	T	100KHz, 1.0V	0.057	3.00
4R7	4.7	T	100KHz, 1.0V	0.071	2.60
6R8	6.8	T	100KHz, 1.0V	0.106	2.10
100	10	T	100KHz, 1.0V	0.140	1.80
220	22	T	100KHz, 1.0V	0.288	1.20
470	47	T	100KHz, 1.0V	0.654	0.80

101B

Codes	L (μH)	Tolerance	Test Condition	DCR (Ω) max.	IDC (A) max.
3R9	3.9	T	100KHz, 1.0V	0.036	3.80
4R7	4.7	T	100KHz, 1.0V	0.039	3.60
6R8	6.8	T	100KHz, 1.0V	0.068	2.70
100	10	T	100KHz, 1.0V	0.082	2.60
150	15	T	100KHz, 1.0V	0.120	1.70
220	22	T	100KHz, 1.0V	0.178	1.40
330	33	T	100KHz, 1.0V	0.252	1.20

LMax SMD Power Inductor



LMMN Series – Miniature Style M

FEATURES

- The miniature chip inductors is wound on a special ferrite core.
- 0302/ 03A2/ 0403 are high Q value at high frequency and low DC resistance.
- 03A2/ 0403/ 0605 are low DC resistance, high current capacity, and high impedance characteristics. They are excellent for using as a choke coil in DC power supply circuits.

APPLICATIONS

- Pagers, Cordless Phone
- High Frequency Communication Products
- Personal Computers
- Disk Drives And Computer Peripherals
- DC Power Supply Circuits

CHARACTERISTICS

Except 0202/02A2/02B2/0302

- Rated DC Current: The current when the inductance becomes 10% lower than its initial value or the current when the temperature of coil increases A T20°C. The smaller one is defined as Rated DC Current. (Ta=25°C)
- Operating temperature range: -40 ~ 85°C

CHARACTERISTICS FOR LWI01/LWI02/LWI03/LWI04

- Rated DC Current (Isat): The current when the inductance becomes 30% typical its initial value (Ta=25°C)
- Temperature Rise Current (I rms): The actual current when the temperature of coil becomes A T=40°C (Ta=25°C)
- Operating temperature range: -40 ~ 105°C

INDUCTANCE AND RATED CURRENT RANGES

- | | | |
|------------|----------------|---------------|
| • 0202 | 1.00 ~ 10μH | 2.80 ~ 0.65A |
| • 02A2 | 1.00 ~ 10μH | 3.70 ~ 0.90A |
| • 02B2 | 1.00 ~ 22μH | 2.30 ~ 0.51A |
| • 0302 | 1.00 ~ 100μH | 1.00 ~ 0.1A |
| • 03A2 | 1.00 ~ 560μH | 0.445 ~ 0.04A |
| • 0403 | 1.00 ~ 2200μH | 0.50 ~ 0.03A |
| • 0302 (C) | 0.47 ~ 120μH | 3.40 ~ 0.17A |
| • 03A2 (C) | 1.00 ~ 560μH | 1.00 ~ 0.06A |
| • 0403 (C) | 1.00 ~ 470μH | 1.08 ~ 0.09A |
| • 0605 (C) | 0.12 ~ 10000μH | 6.00 ~ 0.05A |
- Electrical specifications at 25°C



DIMENSIONS

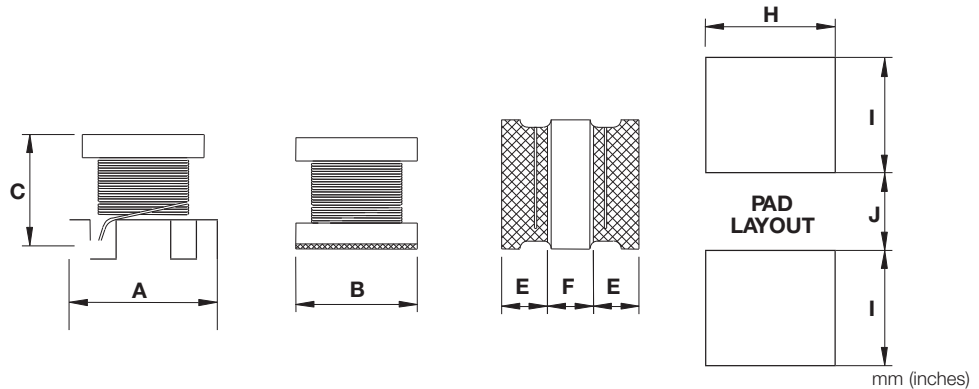

Type	A	B	C	E	F	H	I	J
0202	2.50 ± 0.20 (0.098 ± 0.008)	2.00 ± 0.20 (0.079 ± 0.008)	1.00 max. (0.039)	0.40 ± 0.20 (0.016 ± 0.008)	1.00 min. (0.039)	2.10 (0.083)	0.90 (0.035)	0.80 (0.031)
02A2	2.50 ± 0.20 (0.098 ± 0.008)	2.00 ± 0.20 (0.079 ± 0.008)	1.25 max. (0.049)	0.40 ± 0.20 (0.016 ± 0.008)	1.00 min. (0.039)	2.10 (0.083)	0.90 (0.035)	0.80 (0.031)
02B2	2.50 ± 0.20 (0.098 ± 0.008)	2.50 ± 0.20 (0.098 ± 0.008)	1.05 max. (0.041)	0.85 ref (0.033)	0.85 ref (0.033)	2.50 (0.098)	1.20 (0.047)	0.80 (0.031)
0302 / 0302 (C)	3.20 ± 0.30 (0.126 ± 0.012)	2.50 ± 0.20 (0.098 ± 0.008)	1.55 ± 0.30 (0.061 ± 0.012)	1.05 ± 0.30 (0.041 ± 0.012)	1.05 ± 0.30 (0.041 ± 0.012)	2.00 (0.079)	1.50 (0.059)	1.00 (0.039)
03A2 / 03A2 (C)	3.20 ± 0.30 (0.126 ± 0.012)	2.50 ± 0.20 (0.098 ± 0.008)	2.00 ± 0.30 (0.079 ± 0.012)	1.05 ± 0.30 (0.041 ± 0.012)	1.05 ± 0.30 (0.041 ± 0.012)	2.00 (0.079)	1.50 (0.059)	1.00 (0.039)
0403 / 0403 (C)	4.50 ± 0.30 (0.177 ± 0.012)	3.20 ± 0.20 (0.126 ± 0.008)	2.60 ± 0.30 (0.102 ± 0.012)	1.00 min. (0.039)	1.00 min. (0.039)	3.00 (0.118)	2.00 (0.079)	1.20 (0.047)
0605 (C)	5.70 ± 0.30 (0.224 ± 0.012)	5.00 ± 0.30 (0.197 ± 0.012)	4.70 ± 0.50 (0.185 ± 0.020)	1.30 min. (0.051)	1.70 min. (0.067)	5.00 (0.197)	2.00 (0.079)	2.00 (0.079)

LMax SMD Power Inductor



LMMN Series – Miniature Style M

HOW TO ORDER

LM	MN	0202	N	R04	M	T	A	R
Family	Series	Size	Tolerance	Inductance	Style	Termination	Special	Packaging
LM = Power Inductor	XN = Non-shielded	0202 = 2x2xh (h = see catalog)	J = ±5% K = ±10% M = ±20% N = ±30%	R39 = 0.390µH 3R9 = 3.900µH 390 = 39.00µH 391 = 390.0µH 392 = 3900µH		T = Sn Plate	A = Standard C = Choke	R = 7" Reel

ELECTRICAL CHARACTERISTICS

0202

Codes	L (µH)	Tolerance	Test Condition	DCR (Ω) max.	I rms (A) Typical	I sat (A) Typical
1R0	1.00	M	1MHz, 0.1V	0.085	1.70	2.00
1R5	1.50	M	1MHz, 0.1V	0.128	1.40	1.70
2R2	2.20	M	1MHz, 0.1V	0.19	1.10	1.40
3R3	3.30	M	1MHz, 0.1V	0.304	0.94	1.20
4R7	4.70	M	1MHz, 0.1V	0.44	0.78	0.98
6R8	6.80	M	1MHz, 0.1V	0.541	0.70	0.82
100	10.0	M	1MHz, 0.1V	0.854	0.52	0.65

02A2

Codes	L (µH)	Tolerance	Test Condition	DCR (Ω) max.	I rms (A) Typical	I sat (A) Typical
1R0	1.00	M	1MHz, 0.1V	0.088	1.80	2.70
1R5	1.50	M	1MHz, 0.1V	0.126	1.50	2.20
2R2	2.20	M	1MHz, 0.1V	0.155	1.30	2.00
3R3	3.30	M	1MHz, 0.1V	0.272	1.00	1.60
4R7	4.70	M	1MHz, 0.1V	0.45	0.81	1.20
5R6	5.60	M	1MHz, 0.1V	0.45	0.72	1.15
6R8	6.80	M	1MHz, 0.1V	0.612	0.66	1.10
100	10.0	M	1MHz, 0.1V	0.756	0.59	0.90

02B2

Codes	L (µH)	Tolerance	Test Condition	DCR (Ω) max.	I rms (A) Typical	I sat (A) Typical
1R0	1.00	M	1MHz, 0.1V	0.085	1.90	2.30
1R5	1.50	M	1MHz, 0.1V	0.115	1.50	1.90
2R2	2.20	M	1MHz, 0.1V	0.168	1.20	1.50
3R3	3.30	M	1MHz, 0.1V	0.239	1.10	1.30
4R7	4.70	M	1MHz, 0.1V	0.316	0.90	1.10
5R6	5.60	M	1MHz, 0.1V	0.42	0.83	0.98
6R8	6.80	M	1MHz, 0.1V	0.487	0.80	0.90
8R2	8.20	M	1MHz, 0.1V	0.548	0.71	0.84
100	10.0	M	1MHz, 0.1V	0.61	0.68	0.79
220	22.0	M	1MHz, 0.1V	1.552	0.40	0.51

LMax SMD Power Inductor



LMMN Series – Miniature Style M

0302

Codes	L (µH)	Tolerance	Test Condition	DCR (Ω) max.	IDC (A) max.	SRF (MHz) min.
1R0	1.00	N	1MHz, 0.1V	0.078	1.00	100
1R5	1.50	N	1MHz, 0.1V	0.068	1.20	100
2R2	2.20	M	1MHz, 0.1V	0.126	0.79	64.0
3R3	3.30	M	1MHz, 0.1V	0.18	0.70	50.0
4R7	4.70	M	1MHz, 0.1V	0.195	0.65	43.0
100	10.0	K	1MHz, 0.1V	0.42	0.45	26.0
150	15.0	K	1MHz, 0.1V	0.75	0.30	22.0
220	22.0	K	1MHz, 0.1V	1.00	0.25	19.0
330	33.0	K	1MHz, 0.1V	1.40	0.20	17.0
470	47.0	K	1MHz, 0.1V	2.20	0.17	13.0
680	68.0	K	1MHz, 0.1V	3.20	0.13	9.00
101	100	K	1MHz, 0.1V	4.50	0.10	8.00

03A2

Codes	L (µH)	Tolerance	Test Condition	Quality Factor		DCR (Ω) max.	IDC (A) max.	SRF (MHz) min.
				Spec. min.	Test Condition			
1R0	1.00	M	1MHz, 0.1V	20	1MHz, 0.1V	0.50	0.445	100
1R2	1.20	M	1MHz, 0.1V	20	1MHz, 0.1V	0.60	0.425	100
1R5	1.50	K, M	1MHz, 0.1V	20	1MHz, 0.1V	0.60	0.40	75.0
1R8	1.80	K, M	1MHz, 0.1V	20	1MHz, 0.1V	0.70	0.39	60.0
2R2	2.20	K, M	1MHz, 0.1V	20	1MHz, 0.1V	0.80	0.37	50.0
2R7	2.70	K, M	1MHz, 0.1V	20	1MHz, 0.1V	0.90	0.32	43.0
3R3	3.30	K, M	1MHz, 0.1V	20	1MHz, 0.1V	1.00	0.30	38.0
3R9	3.90	K, M	1MHz, 0.1V	20	1MHz, 0.1V	1.10	0.29	35.0
4R7	4.70	K, M	1MHz, 0.1V	20	1MHz, 0.1V	1.20	0.27	31.0
5R6	5.60	K, M	1MHz, 0.1V	20	1MHz, 0.1V	1.30	0.25	28.0
6R8	6.80	K, M	1MHz, 0.1V	20	1MHz, 0.1V	1.50	0.24	25.0
8R2	8.20	K, M	1MHz, 0.1V	20	1MHz, 0.1V	1.60	0.225	23.0
100	10.0	J, K	1MHz, 0.1V	35	1MHz, 0.1V	1.80	0.19	20.0
120	12.0	J, K	1MHz, 0.1V	35	1MHz, 0.1V	2.00	0.18	18.0
150	15.0	J, K	1MHz, 0.1V	35	1MHz, 0.1V	2.20	0.17	16.0
180	18.0	J, K	1MHz, 0.1V	35	1MHz, 0.1V	2.50	0.165	15.0
220	22.0	J, K	1MHz, 0.1V	35	1MHz, 0.1V	2.80	0.15	14.0
270	27.0	J, K	1MHz, 0.1V	35	1MHz, 0.1V	3.10	0.125	13.0
330	33.0	J, K	1MHz, 0.1V	40	1MHz, 0.1V	3.50	0.115	12.0
390	39.0	J, K	1MHz, 0.1V	40	1MHz, 0.1V	3.90	0.11	11.0
470	47.0	J, K	1MHz, 0.1V	40	1MHz, 0.1V	4.30	0.10	11.0
560	56.0	J, K	1MHz, 0.1V	40	1MHz, 0.1V	4.90	0.085	10.0
680	68.0	J, K	1MHz, 0.1V	40	1MHz, 0.1V	5.50	0.08	9.00
820	82.0	J, K	1MHz, 0.1V	40	1MHz, 0.1V	6.20	0.07	8.50
101	100	J, K	1MHz, 0.1V	40	796KHz, 0.1V	7.00	0.08	8.00
121	120	J, K	1MHz, 0.1V	40	796KHz, 0.1V	8.00	0.075	7.50
151	150	J, K	1MHz, 0.1V	40	796KHz, 0.1V	9.30	0.07	7.00
181	180	J, K	1MHz, 0.1V	40	796KHz, 0.1V	10.20	0.065	6.00
221	220	J, K	1MHz, 0.1V	40	796KHz, 0.1V	11.80	0.065	5.50
271	270	J, K	1MHz, 0.1V	40	796KHz, 0.1V	12.50	0.065	5.00
331	330	J, K	1MHz, 0.1V	40	796KHz, 0.1V	15.00	0.065	5.00
391	390	J, K	1MHz, 0.1V	50	796KHz, 0.1V	22.00	0.05	5.00
471	470	J, K	1KHz, 0.1V	50	796KHz, 0.1V	25.00	0.045	5.00
561	560	J, K	1KHz, 0.1V	50	796KHz, 0.1V	28.00	0.04	5.00 ref

LMax SMD Power Inductor



LMMN Series – Miniature Style M

0403

Codes	L (μ H)	Tolerance	Test Condition	Quality Factor		DCR (Ω) max.	IDC (A) max.	SRF (MHz) min.
				Spec. min.	Test Condition			
1R0	1.00	M	1MHz, 0.1V	20	1MHz, 0.1V	0.20	0.50	120
1R2	1.20	M	1MHz, 0.1V	20	1MHz, 0.1V	0.20	0.50	100
1R5	1.50	M	1MHz, 0.1V	20	1MHz, 0.1V	0.30	0.50	85.0
1R8	1.80	M	1MHz, 0.1V	20	1MHz, 0.1V	0.30	0.50	75.0
2R2	2.20	M	1MHz, 0.1V	20	1MHz, 0.1V	0.30	0.50	62.0
2R7	2.70	M	1MHz, 0.1V	20	1MHz, 0.1V	0.32	0.50	53.0
3R3	3.30	M	1MHz, 0.1V	20	1MHz, 0.1V	0.35	0.50	47.0
3R9	3.90	M	1MHz, 0.1V	20	1MHz, 0.1V	0.38	0.50	41.0
4R7	4.70	K, M	1MHz, 0.1V	30	1MHz, 0.1V	0.40	0.50	38.0
5R6	5.60	K, M	1MHz, 0.1V	30	1MHz, 0.1V	0.47	0.50	33.0
6R8	6.80	K, M	1MHz, 0.1V	30	1MHz, 0.1V	0.50	0.45	31.0
8R2	8.20	K, M	1MHz, 0.1V	30	1MHz, 0.1V	0.56	0.45	27.0
100	10.0	J, K	1MHz, 0.1V	35	1MHz, 0.1V	0.56	0.40	23.0
120	12.0	J, K	1MHz, 0.1V	35	1MHz, 0.1V	0.62	0.38	21.0
150	15.0	J, K	1MHz, 0.1V	35	1MHz, 0.1V	0.73	0.36	19.0
180	18.0	J, K	1MHz, 0.1V	35	1MHz, 0.1V	0.82	0.34	17.0
220	22.0	J, K	1MHz, 0.1V	35	1MHz, 0.1V	0.94	0.32	15.0
270	27.0	J, K	1MHz, 0.1V	35	1MHz, 0.1V	1.10	0.30	14.0
330	33.0	J, K	1MHz, 0.1V	35	1MHz, 0.1V	1.20	0.27	12.0
390	39.0	J, K	1MHz, 0.1V	35	1MHz, 0.1V	1.40	0.24	11.0
470	47.0	J, K	1MHz, 0.1V	35	1MHz, 0.1V	1.50	0.22	10.0
560	56.0	J, K	1MHz, 0.1V	35	1MHz, 0.1V	1.70	0.20	9.30
680	68.0	J, K	1MHz, 0.1V	35	1MHz, 0.1V	1.90	0.18	8.40
820	82.0	J, K	1MHz, 0.1V	35	1MHz, 0.1V	2.20	0.17	7.50
101	100	J, K	1MHz, 0.1V	40	796KHz, 0.1V	2.50	0.16	6.80
121	120	J, K	1MHz, 0.1V	40	796KHz, 0.1V	3.00	0.15	6.20
151	150	J, K	1MHz, 0.1V	40	796KHz, 0.1V	3.70	0.13	5.50
181	180	J, K	1MHz, 0.1V	40	796KHz, 0.1V	4.50	0.12	5.00
221	220	J, K	1MHz, 0.1V	40	796KHz, 0.1V	5.40	0.11	4.50
271	270	J, K	1MHz, 0.1V	40	796KHz, 0.1V	6.80	0.10	4.00
331	330	J, K	1MHz, 0.1V	40	796KHz, 0.1V	8.20	0.095	3.60
391	390	J, K	1MHz, 0.1V	40	796KHz, 0.1V	9.70	0.09	3.30
471	470	J, K	1KHz, 0.1V	40	796KHz, 0.1V	11.80	0.08	3.00
561	560	J, K	1KHz, 0.1V	40	796KHz, 0.1V	14.50	0.07	2.70
681	680	J, K	1KHz, 0.1V	40	796KHz, 0.1V	17.00	0.065	2.50
821	820	J, K	1KHz, 0.1V	40	796KHz, 0.1V	20.50	0.06	2.20
102	1000	J, K	1KHz, 0.1V	40	252KHz, 0.1V	25.00	0.05	2.00
122	1200	J, K	1KHz, 0.1V	40	252KHz, 0.1V	30.00	0.045	1.80
152	1500	J, K	1KHz, 0.1V	40	252KHz, 0.1V	37.00	0.04	1.60
182	1800	J, K	1KHz, 0.1V	40	252KHz, 0.1V	45.00	0.035	1.50
222	2200	J, K	1KHz, 0.1V	40	252KHz, 0.1V	50.00	0.03	1.30

LMax SMD Power Inductor



LMMN Series – Miniature Style M

0302 (C)

Codes	L (μH)	Tolerance	Test Condition	DCR (Ω) ±20%	I sat (A) max.	I rms (A) max.	SRF (MHz) min.
R47	0.47	N	1MHz, 0.1V	0.03	3.40	2.55	100
1R0	1.00	N	1MHz, 0.1V	0.045	2.30	2.05	100
1R5	1.50	N	1MHz, 0.1V	0.057	1.75	1.75	70.0
2R2	2.20	N	1MHz, 0.1V	0.076	1.55	1.60	70.0
3R3	3.30	N	1MHz, 0.1V	0.12	1.25	1.20	50.0
4R7	4.70	N	1MHz, 0.1V	0.18	1.00	1.00	40.0
6R8	6.80	N	1MHz, 0.1V	0.24	0.85	0.85	40.0
100	10.0	M	1MHz, 0.1V	0.38	0.75	0.70	30.0
150	15.0	M	1MHz, 0.1V	0.57	0.60	0.52	20.0
220	22.0	M	1MHz, 0.1V	0.81	0.50	0.45	20.0
330	33.0	M	1MHz, 0.1V	1.15	0.38	0.39	13.0
470	47.0	M	1MHz, 0.1V	1.78	0.33	0.31	11.0
680	68.0	M	1MHz, 0.1V	2.28	0.28	0.275	11.0
101	100	M	1MHz, 0.1V	2.70	0.18	0.25	8.00
121	120	M	1MHz, 0.1V	4.38	0.17	0.20	8.00

03A2 (C)

Codes	L (μH)	Tolerance	Test Condition	DCR (Ω) max.	IDC (A) max.	SRF (MHz) min.
1R0	1.00	M	1MHz, 0.1V	0.078	1.00	100
2R2	2.20	M	1MHz, 0.1V	0.126	0.79	64.0
3R3	3.30	M	1MHz, 0.1V	0.165	0.50	50.0
4R7	4.70	M	1MHz, 0.1V	0.195	0.45	43.0
6R8	6.80	M	1MHz, 0.1V	0.33	0.45	38.0
100	10.0	M	1MHz, 0.1V	0.572	0.30	26.0
220	22.0	K, M	1MHz, 0.1V	0.923	0.25	19.0
470	47.0	K, M	1MHz, 0.1V	1.69	0.17	12.0
101	100	J, K	1MHz, 0.1V	4.55	0.10	8.00
151	150	J, K	1MHz, 0.1V	9.10	0.08	7.00
221	220	J, K	1MHz, 0.1V	10.92	0.07	5.50
331	330	J, K	1MHz, 0.1V	13.0	0.06	4.50
391	390	J, K	1MHz, 0.1V	22.1	0.06	4.00
471	470	J, K	1MHz, 0.1V	24.7	0.06	3.70
561	560	J, K	1MHz, 0.1V	28.6	0.06	3.40

0403 (C)

Codes	L (μH)	Tolerance	Test Condition	DCR (Ω) max.	IDC (A) max.	SRF (MHz) min.
1R0	1.00	M	1MHz, 0.1V	0.08	1.08	100
1R5	1.50	M	1MHz, 0.1V	0.09	1.00	85.0
2R2	2.20	M	1MHz, 0.1V	0.11	0.90	60.0
3R3	3.30	M	1MHz, 0.1V	0.13	0.80	47.0
4R7	4.70	K, M	1MHz, 0.1V	0.15	0.75	35.0
6R8	6.80	K, M	1MHz, 0.1V	0.20	0.72	30.0
100	10.0	J, K	1MHz, 0.1V	0.24	0.65	23.0
150	15.0	J, K	1MHz, 0.1V	0.32	0.57	20.0
220	22.0	J, K	1MHz, 0.1V	0.60	0.42	15.0
330	33.0	J, K	1MHz, 0.1V	1.00	0.31	12.0
470	47.0	J, K	1MHz, 0.1V	1.10	0.28	10.0
680	68.0	J, K	1MHz, 0.1V	1.70	0.22	8.40
101	100	J, K	1MHz, 0.1V	2.20	0.19	6.80
151	150	J, K	1MHz, 0.1V	3.50	0.13	5.50
221	220	J, K	1MHz, 0.1V	4.00	0.11	4.50
331	330	J, K	1MHz, 0.1V	6.80	0.10	3.60
471	470	J, K	1kHz, 0.1V	8.50	0.09	3.00

LMax SMD Power Inductor



LMMN Series – Miniature Style M

0605 (C)

Codes	L (μ H)	Tolerance	Test Condition	DCR (Ω) max.	IDC (A) max.	SRF (MHz) min.
R12	0.12	M	1MHz, 0.1V	0.0098	6.00	450
R27	0.27	M	1MHz, 0.1V	0.014	5.30	300
R47	0.47	M	1MHz, 0.1V	0.0182	4.80	200
1R0	1.00	M	1MHz, 0.1V	0.027	4.00	150
1R5	1.50	M	1MHz, 0.1V	0.031	3.70	110
2R2	2.20	M	1MHz, 0.1V	0.041	3.20	80.0
3R3	3.30	M	1MHz, 0.1V	0.050	2.90	40.0
4R7	4.70	M	1MHz, 0.1V	0.0574	2.70	30.0
6R8	6.80	M	1MHz, 0.1V	0.104	2.00	25.0
100	10.0	K, M	1MHz, 0.1V	0.130	1.70	20.0
150	15.0	K, M	1MHz, 0.1V	0.21	1.40	17.0
220	22.0	K, M	1MHz, 0.1V	0.266	1.20	15.0
330	33.0	K, M	1MHz, 0.1V	0.448	0.90	12.0
470	47.0	K, M	1MHz, 0.1V	0.56	0.80	10.0 ref
680	68.0	K, M	1MHz, 0.1V	0.938	0.64	7.60
101	100	K, M	100KHz, 0.1V	1.204	0.56	6.50
151	150	K, M	100KHz, 0.1V	2.66	0.42	5.00
221	220	K, M	100KHz, 0.1V	3.36	0.32	4.00
331	330	K, M	100KHz, 0.1V	6.16	0.27	3.10
471	470	K, M	100KHz, 0.1V	7.56	0.24	2.40
681	680	K, M	100KHz, 0.1V	11.34	0.19	1.90
102	1000	K, M	10KHz, 0.1V	14.42	0.15	1.70
222	2200	K, M	10KHz, 0.1V	30.1	0.10	1.20
472	4700	K, M	10KHz, 0.1V	61.04	0.07	0.80
103	10000	K, M	10KHz, 0.1V	140.	0.05	0.50

LMax DIP Power Inductor



LMDP Series –Non Shielded Style N

FEATURES

- Density design, small size, and low cost
- Comparatively range rated current and high inductance
- Low DCR and high dip stability

APPLICATIONS

- Personal Computers
- Variety of Battery Power Equipment
- DC Power Supply Circuits

CHARACTERISTICS

- Rated DC Current: The current when the inductance becomes 10% lower than its initial value. (Ta=25°C)
- Operating temperature range -40 ~ 100°C

INDUCTANCE AND RATED CURRENT RANGES

- 0605 22 ~ 1000μH 0.90 ~ 0.13A
- 0606 22 ~ 1000μH 1.27 ~ 0.19A
- 0805 10 ~ 10000μH 2.50 ~ 0.081A
- 0807 10 ~ 10000μH 2.90 ~ 0.084A
- 0809 10 ~ 47000μH 2.60 ~ 0.038A
- 1006 10 ~ 1000μH 3.60 ~ 0.36A
- 1008 10 ~ 1000μH 4.50 ~ 0.45A
- 1010 10 ~ 1000μH 5.30 ~ 0.53A
- Electrical specifications at 25°C



DIMENSIONS



LMDP 0605 / 0606 / 0805 / 0807 / 0809

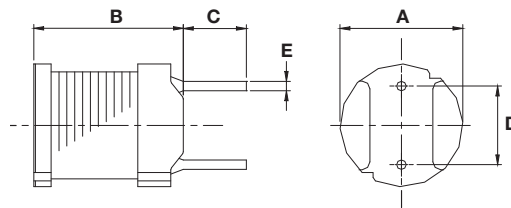

LMDP 1006 / 1008 / 1010

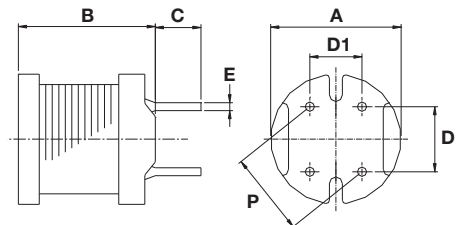

mm (inches)

Type	A	B max.	C	D	D1	E	P
0605	6.00 ± 0.50 (0.236 ± 0.020)	5.00 (0.197)	4.00 ± 1.00 (0.157 ± 0.039)	4.00 ± 0.30 (0.157 ± 0.012)	-	0.50 ± 0.10 (0.010 ± 0.004)	-
0606	6.00 ± 0.50 (0.236 ± 0.020)	6.50 (0.256)	4.00 ± 1.00 (0.157 ± 0.039)	4.00 ± 0.30 (0.157 ± 0.012)	-	0.50 ± 0.10 (0.010 ± 0.004)	-
0805	7.80 ± 0.50 (0.307 ± 0.020)	5.50 (0.217)	5.00 ± 1.00 (0.197 ± 0.039)	5.00 ± 0.30 (0.197 ± 0.012)	-	0.65 ± 0.10 (0.026 ± 0.004)	-
0807	7.80 ± 0.50 (0.307 ± 0.020)	7.50 (0.295)	5.00 ± 1.00 (0.197 ± 0.039)	5.00 ± 0.30 (0.197 ± 0.012)	-	0.65 ± 0.10 (0.026 ± 0.004)	-
0809	7.80 ± 0.50 (0.307 ± 0.020)	9.50 (0.374)	5.00 ± 1.00 (0.197 ± 0.039)	5.00 ± 0.30 (0.197 ± 0.012)	-	0.65 ± 0.10 (0.026 ± 0.004)	-
1006	10.0 ± 0.50 (0.394 ± 0.020)	6.50 (0.256)	3.50 ± 1.00 (0.138 ± 0.039)	5.00 ± 0.30 (0.197 ± 0.012)	4.00 ± 0.30 (0.157 ± 0.012)	0.80 ± 0.10 (0.031 ± 0.004)	6.40 ± 0.50 (0.252 ± 0.020)
1008	10.0 ± 0.50 (0.394 ± 0.020)	8.50 (0.335)	3.50 ± 1.00 (0.138 ± 0.039)	5.00 ± 0.30 (0.197 ± 0.012)	4.00 ± 0.30 (0.157 ± 0.012)	0.65 ± 0.10 (0.026 ± 0.004)	6.40 ± 0.50 (0.252 ± 0.020)
1010	10.0 ± 0.50 (0.394 ± 0.020)	10.5 (0.413)	3.50 ± 1.00 (0.138 ± 0.039)	5.00 ± 0.30 (0.197 ± 0.012)	4.00 ± 0.30 (0.157 ± 0.012)	0.70 ± 0.10 (0.028 ± 0.004)	6.40 ± 0.50 (0.252 ± 0.020)

LMax DIP Power Inductor



LMDP Series –Non Shielded Style N

HOW TO ORDER

LM	DP	0807	M	R04	N	T	A	B
Family	Series	Size	Tolerance	Inductance	Style	Termination	Special	Packaging
LM = Power Inductor	DP = DIP	0807 = 8x7xh (h = see catalog)	K = ±10% M = ±20%	100 = 10µH 101 = 100µH 102 = 1000µH 103 = 10000µH		T = Sn Plate	A = Standard	B = Box

ELECTRICAL CHARACTERISTICS

0605/0606/0805/0807

Codes	L (µH)	Tolerance	Test Condition	DCR (Ω) max.				I sat (A) max*			
				0605	0606	0805	0807	0605	0606	0805	0807
100	10	M	100KHz, 0.1V	–	–	0.07	0.05	–	–	2.50	2.90
120	12	M	100KHz, 0.1V	–	–	0.08	0.06	–	–	2.40	2.50
150	15	M	100KHz, 0.1V	–	–	0.09	0.07	–	–	2.10	2.20
180	18	M	100KHz, 0.1V	–	–	0.10	0.08	–	–	2.00	1.90
220	22	M	100KHz, 0.1V	0.18	0.11	0.12	0.09	0.90	1.27	1.70	1.80
270	27	M	100KHz, 0.1V	0.21	0.14	0.14	0.11	0.81	1.14	1.60	1.70
330	33	M	100KHz, 0.1V	0.27	0.17	0.17	0.13	0.74	1.03	1.40	1.50
390	39	M	100KHz, 0.1V	0.29	0.19	0.21	0.14	0.68	0.95	1.30	1.30
470	47	M	100KHz, 0.1V	0.34	0.23	0.24	0.15	0.62	0.87	1.20	1.30
560	56	M	100KHz, 0.1V	0.42	0.26	0.31	0.18	0.57	0.80	1.10	1.20
680	68	M	100KHz, 0.1V	0.48	0.28	0.34	0.20	0.51	0.72	1.00	1.10
820	82	M	100KHz, 0.1V	0.55	0.39	0.40	0.24	0.47	0.66	0.93	1.00
101	100	K	1KHz, 0.1V	0.68	0.43	0.52	0.28	0.42	0.59	0.81	0.89
121	120	K	1KHz, 0.1V	0.77	0.54	0.59	0.36	0.39	0.54	0.76	0.81
151	150	K	1KHz, 0.1V	0.95	0.64	0.71	0.42	0.35	0.48	0.67	0.72
181	180	K	1KHz, 0.1V	1.15	0.74	0.89	0.57	0.32	0.44	0.62	0.66
221	220	K	1KHz, 0.1V	1.30	0.96	1.04	0.63	0.29	0.40	0.54	0.57
271	270	K	1KHz, 0.1V	1.55	1.12	1.28	0.88	0.26	0.36	0.49	0.51
331	330	K	1KHz, 0.1V	2.18	1.48	1.47	1.05	0.23	0.33	0.44	0.46
391	390	K	1KHz, 0.1V	2.47	1.66	1.67	1.17	0.21	0.30	0.41	0.44
471	470	K	1KHz, 0.1V	2.92	1.91	1.95	1.34	0.20	0.27	0.38	0.41
561	560	K	1KHz, 0.1V	3.97	2.31	2.83	1.72	0.18	0.25	0.35	0.36
681	680	K	1KHz, 0.1V	4.57	2.67	3.25	1.96	0.16	0.23	0.32	0.33
821	820	K	1KHz, 0.1V	5.28	3.10	3.82	2.56	0.15	0.21	0.31	0.30
102	1000	K	1KHz, 0.1V	7.06	4.45	5.28	2.94	0.13	0.19	0.25	0.27
122	1200	K	1KHz, 0.1V	–	–	6.03	4.04	–	–	0.23	0.24
152	1500	K	1KHz, 0.1V	–	–	7.15	4.70	–	–	0.21	0.22
182	1800	K	1KHz, 0.1V	–	–	8.26	5.05	–	–	0.20	0.20
222	2200	K	1KHz, 0.1V	–	–	11.1	6.25	–	–	0.18	0.18
272	2700	K	1KHz, 0.1V	–	–	13.1	8.72	–	–	0.16	0.16
332	3300	K	1KHz, 0.1V	–	–	15.9	10.6	–	–	0.14	0.15
392	3900	K	1KHz, 0.1V	–	–	18.0	14.2	–	–	0.13	0.14
472	4700	K	1KHz, 0.1V	–	–	23.9	16.7	–	–	0.12	0.12
562	5600	K	1KHz, 0.1V	–	–	26.8	18.7	–	–	0.11	0.11
682	6800	K	1KHz, 0.1V	–	–	31.7	21.8	–	–	0.098	0.10
822	8200	K	1KHz, 0.1V	–	–	46.5	28.7	–	–	0.088	0.093
103	10000	K	1KHz, 0.1V	–	–	55.7	33.0	–	–	0.081	0.084

*Saturation Current: The current when the inductance becomes 10% lower than its initial value. (Ta=25°C)

LMax DIP Power Inductor



LMDP Series –Non Shielded Style N

0809/1006/1008/1010

Codes	L (μ H)	Tolerance	Test Condition	DCR (Ω) max.				I sat (A) max*			
				0809	1006	1008	1010	0809	1006	1008	1010
100	10	M	100KHz, 0.1V	0.04	0.040	0.027	0.022	2.60	3.60	4.50	5.30
120	12	M	100KHz, 0.1V	0.04	0.044	0.031	0.023	2.60	3.30	4.10	4.90
150	15	M	100KHz, 0.1V	0.05	0.058	0.036	0.026	2.10	2.90	3.70	4.40
180	18	M	100KHz, 0.1V	0.05	0.064	0.049	0.033	2.00	2.70	3.40	4.00
220	22	M	100KHz, 0.1V	0.06	0.088	0.055	0.037	1.70	2.40	3.10	3.60
270	27	M	100KHz, 0.1V	0.06	0.100	0.062	0.048	1.60	2.20	2.80	3.30
330	33	M	100KHz, 0.1V	0.07	0.110	0.078	0.055	1.40	2.00	2.50	2.90
390	39	M	100KHz, 0.1V	0.08	0.140	0.087	0.073	1.40	1.80	2.30	2.70
470	47	M	100KHz, 0.1V	0.10	0.160	0.099	0.083	1.30	1.70	2.10	2.50
560	56	M	100KHz, 0.1V	0.11	0.190	0.130	0.092	1.20	1.50	1.90	2.30
680	68	M	100KHz, 0.1V	0.14	0.220	0.140	0.120	1.10	1.40	1.70	2.10
820	82	M	100KHz, 0.1V	0.16	0.290	0.160	0.140	1.00	1.30	1.60	1.90
101	100	K	1KHz, 0.1V	0.19	0.320	0.210	0.160	0.90	1.30	1.40	1.70
121	120	K	1KHz, 0.1V	0.22	0.380	0.240	0.200	0.82	1.20	1.30	1.50
151	150	K	1KHz, 0.1V	0.27	0.500	0.320	0.230	0.74	1.00	1.20	1.40
181	180	K	1KHz, 0.1V	0.31	0.560	0.350	0.310	0.71	0.84	1.10	1.30
221	220	K	1KHz, 0.1V	0.38	0.780	0.450	0.340	0.64	0.76	0.96	1.10
271	270	K	1KHz, 0.1V	0.53	0.920	0.610	0.400	0.57	0.69	0.87	1.00
331	330	K	1KHz, 0.1V	0.61	1.100	0.690	0.520	0.51	0.62	0.79	0.93
391	390	K	1KHz, 0.1V	0.69	1.300	0.780	0.650	0.48	0.57	0.72	0.86
471	470	K	1KHz, 0.1V	0.89	1.500	1.000	0.710	0.43	0.52	0.66	0.78
561	560	K	1KHz, 0.1V	1.01	1.900	1.200	1.000	0.40	0.48	0.60	0.71
681	680	K	1KHz, 0.1V	1.18	2.200	1.400	1.100	0.35	0.43	0.55	0.65
821	820	K	1KHz, 0.1V	1.57	2.600	1.800	1.300	0.32	0.40	0.50	0.59
102	1000	K	1KHz, 0.1V	1.84	3.200	2.100	1.700	0.30	0.36	0.45	0.53
122	1200	K	1KHz, 0.1V	2.10	-	-	-	0.27	-	-	-
152	1500	K	1KHz, 0.1V	2.80	-	-	-	0.23	-	-	-
182	1800	K	1KHz, 0.1V	3.21	-	-	-	0.21	-	-	-
222	2200	K	1KHz, 0.1V	4.21	-	-	-	0.19	-	-	-
272	2700	K	1KHz, 0.1V	4.94	-	-	-	0.17	-	-	-
332	3300	K	1KHz, 0.1V	6.16	-	-	-	0.15	-	-	-
392	3900	K	1KHz, 0.1V	6.84	-	-	-	0.14	-	-	-
472	4700	K	1KHz, 0.1V	7.89	-	-	-	0.13	-	-	-
562	5600	K	1KHz, 0.1V	11.50	-	-	-	0.12	-	-	-
682	6800	K	1KHz, 0.1V	13.20	-	-	-	0.11	-	-	-
822	8200	K	1KHz, 0.1V	15.20	-	-	-	0.10	-	-	-
103	10000	K	1KHz, 0.1V	22.00	-	-	-	0.089	-	-	-
123	12000	K	1KHz, 0.1V	25.00	-	-	-	0.073	-	-	-
153	15000	K	1KHz, 0.1V	29.10	-	-	-	0.068	-	-	-
183	18000	K	1KHz, 0.1V	38.90	-	-	-	0.066	-	-	-
223	22000	K	1KHz, 0.1V	44.90	-	-	-	0.059	-	-	-
273	27000	K	1KHz, 0.1V	55.70	-	-	-	0.052	-	-	-
333	33000	K	1KHz, 0.1V	64.20	-	-	-	0.048	-	-	-
393	39000	K	1KHz, 0.1V	74.20	-	-	-	0.042	-	-	-
473	47000	K	1KHz, 0.1V	96.40	-	-	-	0.038	-	-	-

*Saturation Current: The current when the inductance becomes 10% lower than its initial value. (Ta=25°C)

LMax DIP Power Inductor



LMDP Series –Shielded Style P

FEATURES

- Density design, small size, and low cost
- Comparatively range rated current and high inductance
- Low DCR and high dip stability

APPLICATIONS

- Personal Computers
- Variety of Battery Power Equipment
- DC Power Supply Circuits

CHARACTERISTICS

- Rated DC Current: The current when the inductance becomes 10% lower than its initial value. (Ta=25°C)
- Operating temperature range -40 ~ 100°C

INDUCTANCE AND RATED CURRENT RANGES

- 0606 22 ~ 1000μH 0.96 ~ 0.14A
- 0807 22 ~ 10000μH 1.60 ~ 0.074A
- 1008 10 ~ 1000μH 2.80 ~ 0.28A
- 1010 10 ~ 1000μH 3.51 ~ 0.35A
- Electrical specifications at 25°C



DIMENSIONS



LMDP 0606 / 0807

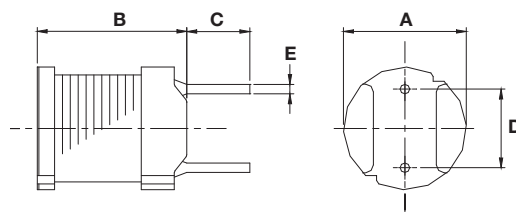

LMDP 1008 / 1010

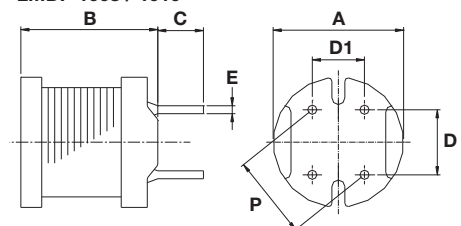

mm (inches)

Type	A	B max.	C	D	D1	E	P
0606	6.00 ± 0.50 (0.236 ± 0.020)	6.50 (0.256)	4.00 ± 1.00 (0.157 ± 0.039)	4.00 ± 0.30 (0.157 ± 0.012)	-	0.50 ± 0.10 (0.010 ± 0.004)	-
0807	7.80 ± 0.50 (0.307 ± 0.020)	7.50 (0.295)	5.00 ± 1.00 (0.197 ± 0.039)	5.00 ± 0.30 (0.197 ± 0.012)	-	0.65 ± 0.10 (0.026 ± 0.004)	-
1008	10.0 ± 0.50 (0.394 ± 0.020)	8.50 (0.335)	3.50 ± 1.00 (0.138 ± 0.039)	5.00 ± 0.30 (0.197 ± 0.012)	4.00 ± 0.30 (0.157 ± 0.012)	0.65 ± 0.10 (0.026 ± 0.004)	6.40 ± 0.50 (0.252 ± 0.020)
1010	10.0 ± 0.5 (0.394 ± 0.020)	10.5 (0.413)	3.5 ± 1.0 (0.138 ± 0.039)	5.0 ± 0.3 (0.197 ± 0.012)	4.0 ± 0.3 (0.157 ± 0.012)	0.70 ± 0.1 (0.028 ± 0.004)	6.40 ± 0.5 (0.252 ± 0.020)

HOW TO ORDER

LM	DP	0606	M	101	P	T	A	B
Family	Series	Size	Tolerance	Inductance	Style	Termination	Special	Packaging
LM = Power Inductor	DP = DIP	0606 = 6x6xh 0807 = 8x7xh 1008 = 10x8xh 1010 = 10x10xh (h = see catalog)	K = ±10% M = ±20%	100 = 10μH 101 = 100μH 102 = 1000μH 103 = 10000μH		T = Sn Plate	A = Standard	B = Box

LMax DIP Power Inductor



LMDP Series –Shielded Style P

ELECTRICAL CHARACTERISTICS

0606/0807/1008/1010

Codes	L (μ H)	Tolerance	Test Condition	DCR (Ω) max.				I sat (A) max*			
				0606	0807	1008	1010	0606	0807	1008	1010
100	10	M	100KHz, 0.1V	–	–	0.05	0.023	–	–	2.80	3.51
120	12	M	100KHz, 0.1V	–	–	0.06	0.024	–	–	2.50	3.24
150	15	M	100KHz, 0.1V	–	–	0.07	0.036	–	–	2.30	2.88
180	18	M	100KHz, 0.1V	–	–	0.08	0.039	–	–	2.10	2.61
220	22	M	100KHz, 0.1V	0.13	0.08	0.09	0.042	0.96	1.60	2.00	2.34
270	27	M	100KHz, 0.1V	0.18	0.10	0.10	0.045	0.87	1.40	1.76	2.16
330	33	M	100KHz, 0.1V	0.21	0.14	0.11	0.057	0.78	1.30	1.60	1.89
390	39	M	100KHz, 0.1V	0.26	0.15	0.12	0.076	0.72	1.20	1.38	1.80
470	47	M	100KHz, 0.1V	0.29	0.17	0.14	0.100	0.66	1.10	1.28	1.62
560	56	M	100KHz, 0.1V	0.33	0.19	0.15	0.110	0.60	0.99	1.20	1.44
680	68	M	100KHz, 0.1V	0.36	0.21	0.16	0.150	0.55	0.89	1.00	1.35
820	82	M	100KHz, 0.1V	0.39	0.27	0.18	0.160	0.50	0.81	0.96	1.26
101	100	K	1KHz, 0.1V	0.54	0.32	0.20	0.190	0.45	0.74	0.92	1.08
121	120	K	1KHz, 0.1V	0.62	0.36	0.24	0.210	0.41	0.67	0.80	0.99
151	150	K	1KHz, 0.1V	0.72	0.51	0.35	0.230	0.37	0.60	0.73	0.90
181	180	K	1KHz, 0.1V	0.88	0.57	0.40	0.260	0.34	0.55	0.64	0.82
221	220	K	1KHz, 0.1V	0.99	0.76	0.54	0.290	0.30	0.50	0.61	0.74
271	270	K	1KHz, 0.1V	1.52	0.86	0.76	0.360	0.27	0.45	0.56	0.67
331	330	K	1KHz, 0.1V	1.69	0.97	0.86	0.510	0.25	0.41	0.50	0.61
391	390	K	1KHz, 0.1V	1.85	1.28	0.93	0.690	0.23	0.37	0.44	0.55
471	470	K	1KHz, 0.1V	2.85	1.44	1.23	0.980	0.21	0.34	0.41	0.51
561	560	K	1KHz, 0.1V	3.21	1.61	1.34	1.100	0.19	0.31	0.38	0.46
681	680	K	1KHz, 0.1V	3.60	2.07	1.53	1.200	0.17	0.28	0.34	0.42
821	820	K	1KHz, 0.1V	4.87	2.33	2.10	1.300	0.16	0.26	0.32	0.38
102	1000	K	1KHz, 0.1V	5.56	2.72	2.30	1.500	0.14	0.23	0.28	0.35
122	1200	K	1KHz, 0.1V	–	3.98	–	–	–	0.21	–	–
152	1500	K	1KHz, 0.1V	–	4.50	–	–	–	0.19	–	–
182	1800	K	1KHz, 0.1V	–	6.81	–	–	–	0.17	–	–
222	2200	K	1KHz, 0.1V	–	7.56	–	–	–	0.16	–	–
272	2700	K	1KHz, 0.1V	–	8.54	–	–	–	0.14	–	–
332	3300	K	1KHz, 0.1V	–	9.74	–	–	–	0.13	–	–
392	3900	K	1KHz, 0.1V	–	12.90	–	–	–	0.12	–	–
472	4700	K	1KHz, 0.1V	–	14.70	–	–	–	0.11	–	–
562	5600	K	1KHz, 0.1V	–	20.40	–	–	–	0.099	–	–
682	6800	K	1KHz, 0.1V	–	23.00	–	–	–	0.089	–	–
822	8200	K	1KHz, 0.1V	–	30.60	–	–	–	0.081	–	–
103	10000	K	1KHz, 0.1V	–	35.00	–	–	–	0.074	–	–

*Saturation Current: The current when the inductance becomes 10% lower than its initial value. (Ta=25°C)

LMax DIP Power Inductor



LMDP Series –Shielded Style S

FEATURES

- Ultra low cost
- Shielded construction
- High current rating up DC 40A
- High frequency range up to 500KHz
- Very low DC resistance
- Low noise

APPLICATIONS

- Motherboards For Laptop And Desktop Computers
- DC/DC Converter

CHARACTERISTICS

- Saturation Rated Current (IDC/Isat) : The DC current when the inductance becomes 20% Typical its initial value. (Ta=25°C)
- Temperature Rise Current (Irms): The actual current when temperature of coil becomes Δ40°C (Ta=25°C)
- Operating Temperature Range: -25°C ~ 125°C

INDUCTANCE AND RATED CURRENT RANGES

- 0707 0.56 ~ 4.7μH 32A ~ 12A
- 0907 0.56 ~ 4.7μH 32A ~ 12A
- 1210 0.22 ~ 4.7μH 56A ~ 15A
- 1312 0.33 ~ 2.2μH 55A ~ 25A
- 1815 10.0 ~ 33μH 11A ~ 6A
- Electrical specifications at 25°C



DIMENSIONS

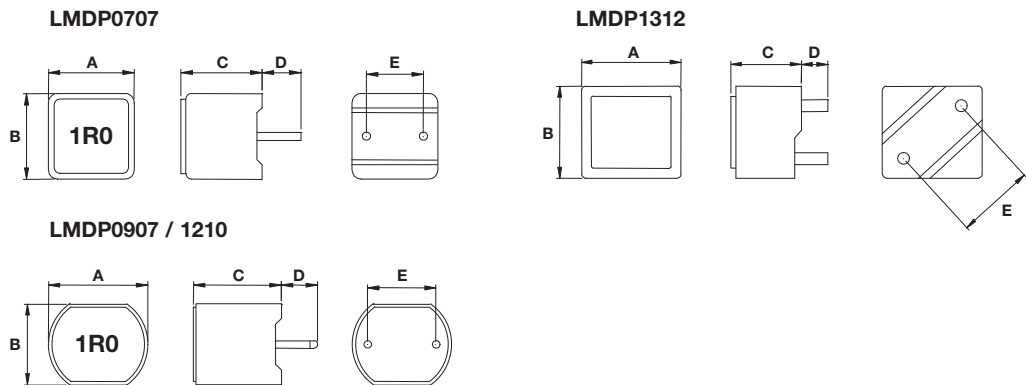

mm (inches)

Type	A	B	C max.	D	E	F
0707	7.50 ± 0.50 (0.295 ± 0.020)	7.50 ± 0.50 (0.295 ± 0.020)	8.50 (0.335)	3.40 ± 0.50 (0.134 ± 0.020)	5.00 ± 0.40 (0.197 ± 0.016)	-
0907	8.70 ± 0.50 (0.343 ± 0.020)	7.20 ± 0.50 (0.283 ± 0.020)	8.50 (0.335)	3.40 ± 0.50 (0.134 ± 0.020)	6.00 ± 0.50 (0.236 ± 0.020)	-
1210	12.3 ± 0.50 (0.484 ± 0.020)	10.2 ± 0.50 (0.402 ± 0.020)	10.0 (0.394)	3.40 ± 0.50 (0.134 ± 0.020)	8.00 ± 0.50 (0.315 ± 0.020)	-
1312	13.0 ± 0.50 (0.512 ± 0.020)	12.0 ± 0.50 (0.472 ± 0.020)	10.0 (0.394)	3.40 ± 0.50 (0.134 ± 0.020)	10.0 ± 0.50 (0.394 ± 0.020)	-

LMax DIP Power Inductor



LMDP Series –Shielded Style S

HOW TO ORDER

LM	DP	0707	M	101	S	T	A	B
Family	Series	Size	Tolerance	Inductance	Style	Termination	Special	Packaging
LM = Power Inductor	DP = DIP	0707 = 7x7xh 0907 = 9x7xh 1210 = 12x10xh 1312 = 13x12xh 1815 = 18x15xh (h = see catalog)	M = ±20%	R56 = 0.56µH 2R2 = 2.20µH 100 = 10.0µH		T = Sn Plate	A = Standard	B = Box

ELECTRICAL CHARACTERISTICS

0707

Codes	L (µH)	Tolerance	Test Condition	DCR (Ω) max.	I sat (A) max*
R56	0.56	M	100KHz, 0.1V	2.50	32
1R0	1.0	M	100KHz, 0.1V	5.60	21
1R5	1.5	M	100KHz, 0.1V	7.50	18
2R2	2.2	M	100KHz, 0.1V	10.0	16
2R8	2.8	M	100KHz, 0.1V	11.8	15
3R3	3.3	M	100KHz, 0.1V	13.6	14
4R7	4.7	M	100KHz, 0.1V	17.0	12

0907

Codes	L (µH)	Tolerance	Test Condition	DCR (Ω) max.	I sat (A) max*
R56	0.56	M	100KHz, 0.1V	2.50	32
1R0	1.0	M	100KHz, 0.1V	5.60	21
1R5	1.5	M	100KHz, 0.1V	7.50	18
2R2	2.2	M	100KHz, 0.1V	10.0	16
2R8	2.8	M	100KHz, 0.1V	11.8	15
3R3	3.3	M	100KHz, 0.1V	13.6	14
4R7	4.7	M	100KHz, 0.1V	17.0	12

1210

Codes	L (µH)	Tolerance	Test Condition	DCR (Ω) max.	I sat (A) max*
R22	0.22	M	100KHz, 0.1V	0.60	56
R33	0.33	M	100KHz, 0.1V	0.80	48
R36	0.36	M	100KHz, 0.1V	0.80	45
R39	0.39	M	100KHz, 0.1V	0.80	45
R47	0.47	M	100KHz, 0.1V	1.00	40
R56	0.56	M	100KHz, 0.1V	1.00	40
R60	0.60	M	100KHz, 0.1V	1.00	40
R68	0.68	M	100KHz, 0.1V	1.00	40
R80	0.80	M	100KHz, 0.1V	1.25	36
1R0	1.0	M	100KHz, 0.1V	2.00	32
1R5	1.5	M	100KHz, 0.1V	3.50	30
2R2	2.2	M	100KHz, 0.1V	5.00	24
2R8	2.8	M	100KHz, 0.1V	6.40	20
3R3	3.3	M	100KHz, 0.1V	7.70	16
4R7	4.7	M	100KHz, 0.1V	10.0	15

*Saturation Current: The DC current when the inductance becomes 20% lower than its initial value. (Ta=25°C)

LMax DIP Power Inductor



LMDP Series –Shielded Style S

1312

Codes	L (μH)	Tolerance	Test Condition	DCR (Ω) max.	I sat (A) max*
R33	0.33	M	100KHz, 0.1V	0.65	55
R39	0.39	M	100KHz, 0.1V	0.65	55
R47	0.47	M	100KHz, 0.1V	0.80	54
R56	0.56	M	100KHz, 0.1V	0.80	52
R60	0.60	M	100KHz, 0.1V	0.80	52
R68	0.68	M	100KHz, 0.1V	0.80	50
R80	0.80	M	100KHz, 0.1V	0.85	48
1R0	1.00	M	100KHz, 0.1V	1.35	40
1R5	1.50	M	100KHz, 0.1V	1.70	38
2R2	2.20	M	100KHz, 0.1V	3.30	25

*Saturation Current: The DC current when the inductance becomes 20% lower than its initial value. (Ta=25°C)



LMax Low Profile Power Inductor



LMLP Series – Style C

FEATURES

- Small and low profile inductor
- It corresponds to high current
- Simple and original magnetic shield structure

APPLICATIONS

- For small DC/DC converter (cellular phone, HDD, DVC, DSC, PDA, LCD display etc.)

CHARACTERISTICS

- Rated DC Current: The current when the inductance becomes 30% lower than its initial value.
- Operating temperature range: -40°C ~ +85°C

INDUCTANCE AND RATED CURRENT RANGES

• 0202	2.2 ~ 22μH	1.290 ~ 0.390A
• 0303	1.0 ~ 47μH	1.30 ~ 0.220A
• 03A3	1.0 ~ 47μH	1.50 ~ 0.250A
• 03B3	1.0 ~ 47μH	2.10 ~ 0.320A
• 0404	1.0 ~ 47μH	1.80 ~ 0.240A
• 04A4	1.0 ~ 47μH	2.50 ~ 0.350A
• 04B4	1.0 ~ 220μH	4.0 ~ 0.270A
• 0505	10μH	1.00A
• 05B5	1.50 ~ 22.0μH	3.35 ~ 0.90A
• 05D5	1.50 ~ 47.0μH	6.00 ~ 1.10A
• 0606	4.7 ~ 10.0μH	1.40 ~ 1.00A
• 06A6	2.50 ~ 100μH	2.10 ~ 0.35A
• 06B6	0.80 ~ 22.0μH	5.50 ~ 1.05A
• 06C6	1.50 ~ 100μH	5.00 ~ 0.62A
• 06D6	1.30 ~ 100μH	8.00 ~ 0.80A
• 0808	0.90 ~ 100μH	11.0 ~ 1.00A



DIMENSIONS

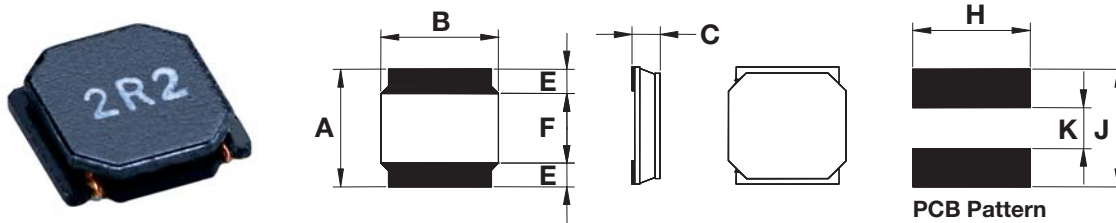

Type	A	B	C max	D	E	F	G	H
0202	2.40 ± 0.10 (0.095 ± 0.004)	2.40 ± 0.10 (0.095 ± 0.004)	1.00 (0.039)	1.45 ± 0.20 (0.057 ± 0.008)	0.60 ± 0.20 (0.240 ± 0.008)	1.45 (0.057)	2.00 (0.079)	0.70 (0.028)
0303	3.00 ± 0.20 (0.118 ± 0.008)	3.00 ± 0.20 (0.118 ± 0.008)	1.00 (0.039)	1.90 ± 0.20 (0.075 ± 0.008)	0.90 ± 0.20 (0.035 ± 0.008)	2.20 (0.087)	2.70 (0.106)	0.80 (0.032)
03A3	3.00 ± 0.20 (0.118 ± 0.008)	3.00 ± 0.20 (0.118 ± 0.008)	1.20 (0.047)	1.90 ± 0.20 (0.075 ± 0.008)	0.90 ± 0.20 (0.035 ± 0.008)	2.20 (0.087)	2.70 (0.106)	0.80 (0.032)
03B3	3.00 ± 0.20 (0.118 ± 0.008)	3.00 ± 0.20 (0.118 ± 0.008)	1.50 (0.059)	1.90 ± 0.20 (0.075 ± 0.008)	0.90 ± 0.20 (0.035 ± 0.008)	2.20 (0.087)	2.70 (0.106)	0.80 (0.032)
0404	4.00 ± 0.20 (0.157 ± 0.008)	4.00 ± 0.20 (0.157 ± 0.008)	1.00 (0.039)	2.50 ± 0.20 (0.099 ± 0.008)	1.10 ± 0.20 (0.043 ± 0.008)	2.80 (0.110)	3.70 (0.146)	1.20 (0.047)
04A4	4.00 ± 0.20 (0.157 ± 0.008)	4.00 ± 0.20 (0.157 ± 0.008)	1.20 (0.047)	2.50 ± 0.20 (0.099 ± 0.008)	1.10 ± 0.20 (0.043 ± 0.008)	2.80 (0.110)	3.70 (0.146)	1.20 (0.047)
04B4	4.00 ± 0.20 (0.157 ± 0.008)	4.00 ± 0.20 (0.157 ± 0.008)	1.80 (0.071)	2.50 ± 0.20 (0.099 ± 0.008)	1.10 ± 0.20 (0.043 ± 0.008)	2.80 (0.110)	3.70 (0.146)	1.20 (0.047)
0505	5.00 ± 0.20 (0.197 ± 0.008)	5.00 ± 0.20 (0.197 ± 0.008)	1.00 (0.039)	3.50 ± 0.20 (0.138 ± 0.008)	1.50 ± 0.20 (0.059 ± 0.008)	3.80 (0.150)	4.70 (0.185)	1.60 (0.063)
05B5	5.00 ± 0.20 (0.197 ± 0.008)	5.00 ± 0.20 (0.197 ± 0.008)	2.00 (0.078)	3.50 ± 0.20 (0.138 ± 0.008)	1.50 ± 0.20 (0.059 ± 0.008)	3.80 (0.150)	4.70 (0.185)	1.60 (0.063)
05D5	5.00 ± 0.20 (0.197 ± 0.008)	5.00 ± 0.20 (0.197 ± 0.008)	4.00 (0.157)	3.50 ± 0.20 (0.138 ± 0.008)	1.50 ± 0.20 (0.059 ± 0.008)	3.80 (0.150)	4.70 (0.185)	1.60 (0.063)
0606	6.00 ± 0.20 (0.236 ± 0.008)	6.00 ± 0.20 (0.236 ± 0.008)	1.00 ± 0.10 (0.039 ± 0.004)	4.00 ± 0.20 (0.157 ± 0.008)	1.35 ± 0.20 (0.053 ± 0.008)	4.70 (0.185)	5.70 (0.224)	1.60 (0.063)
06A6	6.00 ± 0.20 (0.236 ± 0.008)	6.00 ± 0.20 (0.236 ± 0.008)	1.20 (0.047)	4.00 ± 0.20 (0.157 ± 0.008)	1.35 ± 0.20 (0.053 ± 0.008)	4.70 (0.185)	5.70 (0.224)	1.60 (0.063)
06B6	6.00 ± 0.20 (0.236 ± 0.008)	6.00 ± 0.20 (0.236 ± 0.008)	2.00 (0.078)	4.00 ± 0.20 (0.157 ± 0.008)	1.35 ± 0.20 (0.053 ± 0.008)	4.70 (0.185)	5.70 (0.224)	1.60 (0.063)
06C6	6.00 ± 0.20 (0.236 ± 0.008)	6.00 ± 0.20 (0.236 ± 0.008)	2.80 (0.110)	4.00 ± 0.20 (0.157 ± 0.008)	1.35 ± 0.20 (0.053 ± 0.008)	4.70 (0.185)	5.70 (0.224)	1.60 (0.063)
06D6	6.00 ± 0.20 (0.236 ± 0.008)	6.00 ± 0.20 (0.236 ± 0.008)	4.50 (0.177)	4.00 ± 0.20 (0.157 ± 0.008)	1.35 ± 0.20 (0.053 ± 0.008)	4.70 (0.185)	5.70 (0.224)	1.60 (0.063)
0808	8.00 ± 0.20 (0.315 ± 0.008)	8.00 ± 0.20 (0.315 ± 0.008)	4.20 (0.165)	5.60 ± 0.30 (0.220 ± 0.011)	1.60 ± 0.30 (0.063 ± 0.011)	5.60 (0.220)	7.50 (0.188)	1.80 (0.071)



LMax Low Profile Power Inductor



LMLP Series – Style C

HOW TO ORDER

LM ┆ ┆ ┆	LP ┆ ┆ ┆	0303 ┆ ┆ ┆	M ┆ ┆ ┆	R04 ┆ ┆ ┆	C ┆ ┆ ┆	T ┆ ┆ ┆	A ┆ ┆ ┆	S ┆ ┆ ┆
Family	Series	Size	Tolerance	Inductance	Style	Termination	Special	Packaging
LM = Power Inductor	LP = Low Profile	0303 = 3x3xh 03A3 = 3x3xA(h) (h = see catalog)	M = 20% N = 30%	R39 = 0.390μH 3R9 = 3.900μH 390 = 39.00μH 391 = 390.0μH		T = Sn Plate	A = Standard	R = 7" Reel S = 13" Reel

ELECTRICAL CHARACTERISTICS

0202

Code	Inductance L(μH) At 100KHz, 1.0V	Tolerance	Rated Current (A)		DC Resistance (Ω) ±20%
			Saturation Current Idc1	Temperature Rise Current Idc2	
N2R2	2.20	±30%	1.29	0.97	0.15
N3R3	3.30	±30%	1.00	0.77	0.22
N4R7	4.70	±30%	0.88	0.67	0.29
N6R8	6.80	±30%	0.75	0.57	0.41
M100	10.0	±20%	0.55	0.45	0.69
M150	15.0	±20%	0.47	0.37	1.02
M220	22.0	±20%	0.39	0.30	1.47

0303

Code	Inductance L(μH) At 100KHz, 1.0V	Tolerance	Rated Current (A)		DC Resistance (Ω) ±20%
			Saturation Current Idc1	Temperature Rise Current Idc2	
N1R0	1.00	±30%	1.30	1.40	0.065
N1R5	1.50	±30%	1.20	1.30	0.08
N2R2	2.20	±30%	1.10	1.10	0.095
N3R3	3.30	±30%	0.87	0.94	0.14
N4R7	4.70	±30%	0.75	0.78	0.19
N6R8	6.80	±30%	0.61	0.63	0.30
M100	10.0	±20%	0.50	0.51	0.45
M150	15.0	±20%	0.40	0.40	0.74
M220	22.0	±20%	0.35	0.35	1.03
M330	33.0	±20%	0.26	0.275	1.55
M470	47.0	±20%	0.22	0.235	2.05

03A3

Code	Inductance L(μH) At 100KHz, 1.0V	Tolerance	Rated Current (A)		DC Resistance (Ω) ±20%
			Saturation Current Idc1	Temperature Rise Current Idc2	
N1R0	1.00	±30%	1.50	1.49	0.05
N1R5	1.50	±30%	1.36	1.40	0.06
N2R2	2.20	±30%	1.10	1.20	0.08
N3R3	3.30	±30%	0.91	1.05	0.10
N4R7	4.70	±30%	0.77	0.98	0.13
N6R8	6.80	±30%	0.67	0.74	0.19
M100	10.0	±20%	0.54	0.63	0.29
M150	15.0	±20%	0.44	0.485	0.45
M220	22.0	±20%	0.37	0.42	0.63
M330	33.0	±20%	0.31	0.33	1.03
M470	47.0	±20%	0.25	0.28	1.45

LMax Low Profile Power Inductor



LMLP Series – Style C

03B3

Code	Inductance L(μH) At 100KHz, 1.0V	Tolerance	Rated Current (A)		DC Resistance (Ω) ±20%
			Saturation Current Idc1	Temperature Rise Current Idc2	
N1R0	1.00	±30%	2.10	2.10	0.03
N1R5	1.50	±30%	1.80	1.82	0.04
N2R2	2.20	±30%	1.48	1.50	0.06
N3R3	3.30	±30%	1.21	1.23	0.08
N4R7	4.70	±30%	1.02	1.04	0.12
N6R8	6.80	±30%	0.87	0.88	0.16
M100	10.0	±20%	0.70	0.71	0.23
M150	15.0	±20%	0.56	0.56	0.36
M220	22.0	±20%	0.47	0.47	0.52
M330	33.0	±20%	0.39	0.37	0.84
M470	47.0	±20%	0.32	0.30	1.34

0404

Code	Inductance L(μH) At 100KHz, 1.0V	Tolerance	Rated Current (A)		DC Resistance (Ω) ±20%
			Saturation Current Idc1	Temperature Rise Current Idc2	
N1R0	1.00	±30%	1.80	1.05	0.10
N2R2	2.20	±30%	1.15	0.89	0.15
N3R3	3.30	±30%	1.10	0.82	0.18
N4R7	4.70	±30%	0.90	0.75	0.21
N6R8	6.80	±30%	0.74	0.62	0.30
M100	10.0	±30%	0.56	0.60	0.38
M150	15.0	±20%	0.47	0.51	0.51
M220	22.0	±20%	0.36	0.40	0.87
M330	33.0	±20%	0.28	0.30	1.54
M470	47.0	±20%	0.24	0.28	1.81

04A4

Code	Inductance L(μH) At 100KHz, 1.0V	Tolerance	Rated Current (A)		DC Resistance (Ω) ±20%
			Saturation Current Idc1	Temperature Rise Current Idc2	
N1R0	1.00	±30%	2.50	1.50	0.06
N2R2	2.20	±30%	1.65	1.20	0.09
N3R3	3.30	±30%	1.20	0.98	0.13
N4R7	4.70	±30%	1.05	0.96	0.14
N6R8	6.80	±30%	0.90	0.84	0.18
M100	10.0	±20%	0.74	0.77	0.24
M150	15.0	±20%	0.56	0.60	0.40
M220	22.0	±20%	0.51	0.54	0.48
M330	33.0	±20%	0.40	0.42	0.81
M470	47.0	±20%	0.35	0.37	1.00

LMax Low Profile Power Inductor



LMLP Series – Style C

04B4

Code	Inductance L(μH) At 100KHz, 1.0V	Tolerance	Rated Current (A)		DC Resistance (Ω) ±20%
			Saturation Current Idc1	Temperature Rise Current Idc2	
N1R0	1.00	±30%	4.00	1.83	0.03
N2R2	2.20	±30%	2.70	1.44	0.06
N3R3	3.30	±30%	2.00	1.23	0.07
N4R7	4.70	±30%	1.70	1.20	0.09
N6R8	6.80	±30%	1.45	1.06	0.11
M100	10.0	±20%	1.20	0.84	0.18
M150	15.0	±20%	0.94	0.65	0.28
M220	22.0	±20%	0.80	0.59	0.36
M330	33.0	±20%	0.65	0.49	0.53
M470	47.0	±20%	0.57	0.42	0.65
M680	68.0	±20%	0.47	0.32	1.00
M101	100	±20%	0.40	0.27	1.50
M151	150	±20%	0.31	0.22	2.50
M221	220	±20%	0.27	0.17	4.00

0505

Code	Inductance L(μH) At 100KHz, 1.0V	Tolerance	Rated Current (A)		DC Resistance (Ω) ±20%
			Saturation Current Idc1	Temperature Rise Current Idc2	
M100	10.0	±20%	1.00	0.94	0.48

05B5

Code	Inductance L(μH) At 100KHz, 1.0V	Tolerance	Rated Current (A)		DC Resistance (Ω) ±20%
			Saturation Current Idc1	Temperature Rise Current Idc2	
N1R5	1.50	±30%	3.35	3.20	0.026
N2R2	2.20	±30%	2.90	2.90	0.035
N3R3	3.30	±30%	2.40	2.40	0.048
N4R7	4.70	±30%	2.00	2.00	0.06
N6R8	6.80	±30%	1.60	1.65	0.090
M100	10.0	±20%	1.30	1.45	0.12
M150	15.0	±20%	1.10	1.20	0.165
M220	22.0	±20%	0.90	1.00	0.26

05D5

Code	Inductance L(μH) At 100KHz, 1.0V	Tolerance	Rated Current (A)		DC Resistance (Ω) ±20%
			Saturation Current Idc1	Temperature Rise Current Idc2	
N1R5	1.50	±30%	6.00	3.60	0.02
N2R2	2.20	±30%	4.60	3.50	0.022
N3R3	3.30	±30%	3.80	3.30	0.027
N4R7	4.70	±30%	3.30	3.10	0.029
N6R8	6.80	±30%	2.60	2.30	0.049
M100	10.0	±20%	2.30	2.10	0.056
M150	15.0	±20%	2.00	1.80	0.08
M220	22.0	±20%	1.60	1.40	0.126
M330	33.0	±20%	1.30	1.20	0.18
M470	47.0	±20%	1.10	0.90	0.31

LMax Low Profile Power Inductor



LMLP Series – Style C

0606

Code	Inductance L(μH) At 100KHz, 1.0V	Tolerance	Rated Current (A)		DC Resistance (Ω) ±20%
			Saturation Current Idc1	Temperature Rise Current Idc2	
N4R7	4.70	±30%	1.40	1.40	0.29
N6R8	6.80	±30%	1.20	1.00	0.372
M100	10.0	±20%	1.00	0.85	0.50

06A6

Code	Inductance L(μH) At 100KHz, 1.0V	Tolerance	Rated Current (A)		DC Resistance (Ω) ±20%
			Saturation Current Idc1	Temperature Rise Current Idc2	
N2R5	2.50	±30%	2.10	1.73	0.09
N4R0	4.00	±30%	1.80	1.57	0.105
N5R0	5.00	±30%	1.50	1.40	0.11
N6R8	6.80	±30%	1.30	1.18	0.165
M100	10.0	±20%	1.00	1.00	0.235
M150	15.0	±20%	0.80	0.79	0.33
M220	22.0	±20%	0.76	0.63	0.530
M330	23.0	±20%	0.59	0.53	0.70
M470	47.0	±20%	0.52	0.46	1.05
M680	68.0	±20%	0.44	0.41	1.35
M101	100	±20%	0.35	0.32	2.18

06B6

Code	Inductance L(μH) At 100KHz, 1.0V	Tolerance	Rated Current (A)		DC Resistance (Ω) ±20%
			Saturation Current Idc1	Temperature Rise Current Idc2	
N0R8	0.80	±30%	5.50	3.80	0.02
N1R5	1.50	±30%	4.00	3.20	0.026
N2R2	2.20	±30%	3.20	2.70	0.034
N3R3	3.30	±30%	2.80	2.60	0.04
N4R7	4.70	±30%	2.40	2.00	0.058
N6R8	6.80	±30%	2.00	1.80	0.085
M100	10.0	±20%	1.70	1.40	0.125
M220	22.0	±20%	1.05	0.95	0.29

06C6

Code	Inductance L(μH) At 100KHz, 1.0V	Tolerance	Rated Current (A)		DC Resistance (Ω) ±20%
			Saturation Current Idc1	Temperature Rise Current Idc2	
N1R5	1.50	±30%	5.00	4.20	0.016
N2R2	2.20	±30%	4.20	3.70	0.02
N3R0	3.00	±30%	3.60	3.40	0.023
N4R7	4.70	±30%	2.70	3.00	0.031
N6R0	6.00	±30%	2.50	2.50	0.04
M100	10.0	±20%	1.90	1.90	0.065
M150	15.0	±20%	1.60	1.80	0.095
M220	22.0	±20%	1.30	1.40	0.135
M330	33.0	±20%	1.10	1.10	0.22
M470	47.0	±20%	0.95	0.92	0.30
M680	68.0	±20%	0.76	0.77	0.42
M101	100	±20%	0.62	0.66	0.60

LMax Low Profile Power Inductor



LMLP Series – Style C

06D6

Code	Inductance L(μH) At 100KHz, 1.0V	Tolerance	Rated Current (A)		DC Resistance (Ω) ±20%
			Saturation Current Idc1	Temperature Rise Current Idc2	
N1R3	1.30	±30%	8.00	4.00	0.016
N1R8	1.80	±30%	7.00	3.70	0.018
N2R3	2.30	±30%	6.00	3.50	0.021
N3R0	3.00	±30%	5.00	3.20	0.024
N4R5	4.50	±30%	4.00	3.00	0.031
N6R3	6.30	±30%	3.80	2.80	0.038
M100	10.0	±20%	3.00	2.50	0.047
M150	15.0	±20%	2.30	1.90	0.077
M220	22.0	±20%	1.90	1.50	0.115
M330	33.0	±20%	1.50	1.40	0.145
M470	47.0	±20%	1.30	1.10	0.22
M680	68.0	±20%	1.00	0.90	0.33
M101	100	±20%	0.80	0.70	0.50

0808

Code	Inductance L(μH) At 100KHz, 1.0V	Tolerance	Rated Current (A)		DC Resistance (Ω) ±20%
			Saturation Current Idc1	Temperature Rise Current Idc2	
N0R9	0.90	±30%	11.0	7.80	0.006
N1R4	1.40	±30%	9.00	7.00	0.007
N2R0	2.00	±30%	7.40	6.30	0.009
N3R6	3.60	±30%	5.30	4.90	0.015
N4R7	4.70	±30%	4.70	4.10	0.018
N6R8	6.80	±30%	4.00	3.70	0.025
M100	10.0	±20%	3.40	3.10	0.034
M150	15.0	±20%	2.70	2.40	0.05
M220	22.0	±20%	2.20	2.20	0.066
M330	33.0	±20%	1.90	1.70	0.10
M470	47.0	±20%	1.50	1.40	0.15
M680	68.0	±20%	1.20	1.10	0.23
M101	100	±20%	1.00	1.00	0.29

NOTES:

1. Operating Temp: -25°C±120°C
2. The saturation current value (Idc1) is the DC current value having inductance decrease down 30% (at 20°C).
3. The temperature rise current value (Idc2) is the DC current value having temperature increase up to 40°C (at 20°C).
4. The rated current is the DC current value that satisfies both of current value saturation current value and temperature rise current value.

LMax Low Profile/High Current Power Inductor



LMLP Series – Style D

FEATURES

- Large Current Rating
- Lower Temperature Rise
- Low Profile
- Available on tape and reel

APPLICATIONS

- Personal Computers
- Servers
- High Current POL Converters
- Low Profile High Current Power Supplies
- DC/DC Converters
- DC/DC Converters for FPGA

INDUCTANCE AND RATED CURRENT RANGES

• 0405	0.1 μ H ~ 3.3 μ H	22 ~ 4 A
• 05A6	0.1 μ H ~ 4.7 μ H	45 ~ 5 A
• 0506	0.1 μ H ~ 4.7 μ H	27 ~ 8.2 A
• 0707	0.1 μ H ~ 4.7 μ H	40 ~ 8 A
• 07A7	0.1 μ H ~ 10 μ H	50 ~ 7 A
• 07B7	0.1 μ H ~ 10 μ H	60 ~ 7 A
• 07C7	0.56 μ H ~ 10 μ H	12 ~ 4.5 A
• 1011	0.19 μ H ~ 47 μ H	90 ~ 3 A
• 13A3	0.1 μ H ~ 10 μ H	84 ~ 14 A
• 1313	0.1 μ H ~ 10 μ H	118 ~ 16 A
• 13B3	0.1 μ H ~ 10 μ H	120 ~ 15.5 A

- All test data taken at 25°C
- Operating Temperature Range: -55°C ~ +155°C
- I_{SAT} : The current that causes an inductance drop of approximately 25% (30% on 0405 size).
- I_{DC} : DC Current that causes an approximate ΔT of 40°C.



DIMENSIONS

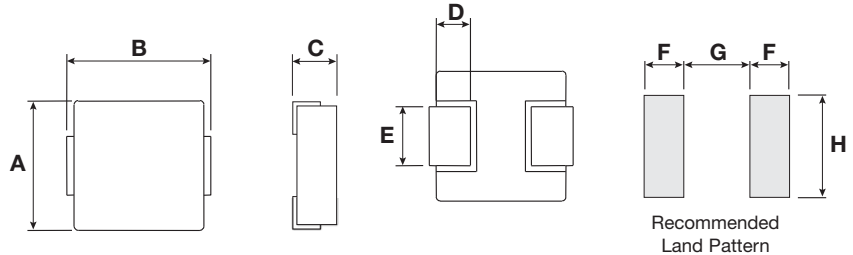

mm (inches)

Type	A	B	C	D	E	F	G	H
0405	4.10±0.50 (0.161±0.020)	4.50±0.50 (0.177±0.020)	2.10 (0.083)	0.80±0.50 (0.031±0.020)	1.50±0.50 (0.059±0.020)	1.50 (0.059)	2.50 (0.098)	2.20 (0.087)
05A6	5.00±0.50 (0.197±0.020)	5.50±0.50 (0.217±0.020)	2.00 (0.083)	1.20±0.50 (0.047±0.020)	1.50±0.50 (0.059±0.020)	2.00 (0.079)	3.00 (0.118)	2.50 (0.098)
0506	5.00±0.50 (0.197±0.020)	5.50±0.50 (0.217±0.020)	3.00 (0.118)	1.20±0.50 (0.047±0.020)	1.50±0.50 (0.059±0.020)	2.00 (0.079)	3.00 (0.118)	2.50 (0.098)
0707	6.80 max (0.278 max)	7.50 max (0.295 max)	2.00 (0.083)	1.60±0.50 (0.063±0.020)	2.90±0.50 (0.114±0.020)	2.50 (0.098)	3.70 (0.146)	3.50 (0.138)
07A7	6.80 max (0.278 max)	7.50 max (0.295 max)	2.50 (0.098)	1.60±0.50 (0.063±0.020)	2.90±0.50 (0.114±0.020)	2.50 (0.098)	3.70 (0.146)	3.50 (0.138)
07B7	6.80 max (0.278 max)	7.50 max (0.295 max)	3.00 (0.118)	1.60±0.50 (0.063±0.020)	2.90±0.50 (0.114±0.020)	2.50 (0.098)	3.70 (0.146)	3.50 (0.138)
07C7	6.80 max (0.278 max)	7.50 max (0.295 max)	5.00 (0.197)	1.60±0.50 (0.063±0.020)	2.90±0.50 (0.114±0.020)	2.50 (0.098)	3.70 (0.146)	3.50 (0.138)
1011	10.4 max (0.409 max)	11.5 max (0.453 max)	4.00 (0.157)	2.00±0.50 (0.079±0.020)	2.90±0.50 (0.114±0.020)	3.50 (0.138)	6.00 (0.236)	4.00 (0.157)
13A3	13.0 max (0.512 max)	14.2 max (0.559 max)	4.00 (0.157)	2.30±0.50 (0.091±0.020)	3.80±0.50 (0.150±0.020)	2.90 (0.114)	7.90 (0.311)	5.00 (0.197)
1313	13.0 max (0.512 max)	14.2 max (0.559 max)	5.00 (0.197)	2.30±0.50 (0.091±0.020)	3.80±0.50 (0.150±0.020)	2.90 (0.114)	7.90 (0.311)	5.00 (0.197)
13B3	13.0 max (0.512 max)	14.2 max (0.559 max)	6.50 (0.256)	2.30±0.50 (0.091±0.020)	3.80±0.50 (0.150±0.020)	2.90 (0.114)	7.90 (0.311)	5.00 (0.197)

LMax Low Profile/High Current Power Inductor



LMLP Series – Style D

HOW TO ORDER

LM Family	LP Series	0707 Size	M Tolerance	R04 Inductance	D Style	T Termination	A Special	S Packaging
LM = Power Inductor	LP = Low Profile	0707 = 7x7xh 07A7 = 7x7xA(h) (h = see catalog)	M = 20%	R39 = 0.390μH 3R9 = 3.900μH 390 = 39.00μH 391 = 390.0μH		T = Sn Plate	A = Standard	S = 13" Reel

ELECTRICAL CHARACTERISTICS

0405

AVX PN	Inductance (μH)	Tolerance	Test Condition	DCR (Ω)	ISAT (A)	IDC (A)
LMLP0405MR10DTAS	0.1	±20%	100KHz, 0.25V	4	22	12
LMLP0405MR22DTAS	0.22	±20%	100KHz, 0.25V	6.6	12.5	9
LMLP0405MR47DTAS	0.47	±20%	100KHz, 0.25V	14	9.5	7
LMLP0405MR56DTAS	0.56	±20%	100KHz, 0.25V	16	8.5	6.5
LMLP0405M1R0DTAS	1	±20%	100KHz, 0.25V	27	7	4.5
LMLP0405M1R5DTAS	1.5	±20%	100KHz, 0.25V	46	6	4
LMLP0405M2R2DTAS	2.2	±20%	100KHz, 0.25V	58	5	3
LMLP0405M3R3DTAS	3.3	±20%	100KHz, 0.25V	87	4	2.5

05A6

AVX PN	Inductance (μH)	Tolerance	Test Condition	DCR (Ω)	ISAT (A)	IDC (A)
LMLP05A6MR10DTAS	0.1	±20%	100KHz, 0.25V	3.9	45	17
LMLP05A6MR22DTAS	0.22	±20%	100KHz, 0.25V	5.2	22	15
LMLP05A6MR33DTAS	0.33	±20%	100KHz, 0.25V	8.2	25	12
LMLP05A6MR47DTAS	0.47	±20%	100KHz, 0.25V	9.4	21	11.5
LMLP05A6MR68DTAS	0.68	±20%	100KHz, 0.25V	12.4	15	10
LMLP05A6M1R0DTAS	1	±20%	100KHz, 0.25V	20	16	7
LMLP05A6M2R2DTAS	2.2	±20%	100KHz, 0.25V	50.1	12.5	4.2
LMLP05A6M3R3DTAS	3.3	±20%	100KHz, 0.25V	85.5	8.5	3.3
LMLP05A6M4R7DTAS	4.7	±20%	100KHz, 0.25V	116.6	5	2.8

0506

AVX PN	Inductance (μH)	Tolerance	Test Condition	DCR (Ω)	ISAT (A)	IDC (A)
LMLP0506MR10DTAS	0.1	±20%	100KHz, 0.25V	3.16	27	23
LMLP0506MR22DTAS	0.22	±20%	100KHz, 0.25V	4.52	21	15.5
LMLP0506MR33DTAS	0.33	±20%	100KHz, 0.25V	5.56	19	13.7
LMLP0506MR47DTAS	0.47	±20%	100KHz, 0.25V	7.04	16	12.2
LMLP0506MR68DTAS	0.68	±20%	100KHz, 0.25V	8.96	13.5	10.2
LMLP0506MR82DTAS	0.82	±20%	100KHz, 0.25V	11.9	13	9.3
LMLP0506M1R0DTAS	1	±20%	100KHz, 0.25V	13.7	12	9.2
LMLP0506M1R5DTAS	1.5	±20%	100KHz, 0.25V	20.7	11	7.2
LMLP0506M2R2DTAS	2.2	±20%	100KHz, 0.25V	29.2	10	5.8
LMLP0506M3R3DTAS	3.3	±20%	100KHz, 0.25V	54.7	8.5	5
LMLP0506M4R7DTAS	4.7	±20%	100KHz, 0.25V	77.5	8.2	3.5

ISAT: The current that causes an inductance drop of approximately 25% (30% on 0405 size).

IDC: DC Current that causes an approximate ΔT of 40°C.

LMax Low Profile/High Current Power Inductor



LMLP Series – Style D

0707

AVX PN	Inductance (μH)	Tolerance	Test Condition	DCR (Ω)	IsAT (A)	I _{DC} (A)
LMLP0707MR10DTAS	0.1	±20%	100KHz, 0.25V	3.5	40	18
LMLP0707MR15DTAS	0.15	±20%	100KHz, 0.25V	5.2	38	15
LMLP0707MR22DTAS	0.22	±20%	100KHz, 0.25V	5.7	26	14
LMLP0707MR33DTAS	0.33	±20%	100KHz, 0.25V	7	18	12
LMLP0707MR47DTAS	0.47	±20%	100KHz, 0.25V	9.3	18	11
LMLP0707MR68DTAS	0.68	±20%	100KHz, 0.25V	13.9	17	9
LMLP0707MR82DTAS	0.82	±20%	100KHz, 0.25V	15.9	17	8
LMLP0707M1R0DTAS	1	±20%	100KHz, 0.25V	18.3	14	7
LMLP0707M1R5DTAS	1.5	±20%	100KHz, 0.25V	34	11.5	4
LMLP0707M2R2DTAS	2.2	±20%	100KHz, 0.25V	46	13	3.75
LMLP0707M3R3DTAS	3.3	±20%	100KHz, 0.25V	60.1	10	3.25
LMLP0707M4R7DTAS	4.7	±20%	100KHz, 0.25V	78	8	3

07B7

AVX PN	Inductance (μH)	Tolerance	Test Condition	DCR (Ω)	IsAT (A)	I _{DC} (A)
LMLP07B7MR10DTAS	0.1	±20%	100KHz, 0.25V	1.7	50	30
LMLP07B7MR22DTAS	0.22	±20%	100KHz, 0.25V	3.2	34	21
LMLP07B7MR33DTAS	0.33	±20%	100KHz, 0.25V	4.1	22	18
LMLP07B7MR47DTAS	0.47	±20%	100KHz, 0.25V	6.5	21	13.5
LMLP07B7MR68DTAS	0.68	±20%	100KHz, 0.25V	9.4	18	11
LMLP07B7MR82DTAS	0.82	±20%	100KHz, 0.25V	11.8	17	10
LMLP07B7M1R0DTAS	1	±20%	100KHz, 0.25V	14.2	16	9
LMLP07B7M1R5DTAS	1.5	±20%	100KHz, 0.25V	21.2	15	7.5
LMLP07B7M2R2DTAS	2.2	±20%	100KHz, 0.25V	34	14	6.5
LMLP07B7M3R3DTAS	3.3	±20%	100KHz, 0.25V	51.6	13	5
LMLP07B7M4R7DTAS	4.7	±20%	100KHz, 0.25V	63	10	4.5
LMLP07B7M6R8DTAS	6.8	±20%	100KHz, 0.25V	95	9	3.5
LMLP07B7M8R2DTAS	8.2	±20%	100KHz, 0.25V	106	8	3
LMLP07B7M100DTAS	10	±20%	100KHz, 0.25V	129	7	2.5

07A7

AVX PN	Inductance (μH)	Tolerance	Test Condition	DCR (Ω)	IsAT (A)	I _{DC} (A)
LMLP07A7MR10DTAS	0.1	±20%	100KHz, 0.25V	1.7	60	32.5
LMLP07A7MR22DTAS	0.22	±20%	100KHz, 0.25V	2.8	40	23
LMLP07A7MR33DTAS	0.33	±20%	100KHz, 0.25V	3.9	30	20
LMLP07A7MR47DTAS	0.47	±20%	100KHz, 0.25V	4.2	26	17.5
LMLP07A7MR68DTAS	0.68	±20%	100KHz, 0.25V	5.5	25	15.5
LMLP07A7MR82DTAS	0.82	±20%	100KHz, 0.25V	8	24	13
LMLP07A7M1R0DTAS	1	±20%	100KHz, 0.25V	10	22	11
LMLP07A7M1R5DTAS	1.5	±20%	100KHz, 0.25V	15	18	9
LMLP07A7M2R2DTAS	2.2	±20%	100KHz, 0.25V	20	14	8
LMLP07A7M3R3DTAS	3.3	±20%	100KHz, 0.25V	30	13.5	6
LMLP07A7M4R7DTAS	4.7	±20%	100KHz, 0.25V	40	10	5.5
LMLP07A7M6R8DTAS	6.8	±20%	100KHz, 0.25V	60	8	4.5
LMLP07A7M8R2DTAS	8.2	±20%	100KHz, 0.25V	68	7.5	4
LMLP07A7M100DTAS	10	±20%	100KHz, 0.25V	105	7	3

IsAT: The current that causes an inductance drop of approximately 25%.
 I_{DC}: DC Current that causes an approximate ΔT of 40°C.

LMax Low Profile/High Current Power Inductor



LMLP Series – Style D

07C7

AVX PN	Inductance (μH)	Tolerance	Test Condition	DCR (Ω)	IsAT (A)	I _{DC} (A)
LMLP07C7MR56DTAS	0.56	±20%	100KHz, 0.25V	3.6	12	20
LMLP07C7MR68DTAS	0.68	±20%	100KHz, 0.25V	4.5	11.5	18
LMLP07C7MR82DTAS	0.82	±20%	100KHz, 0.25V	4.9	13	16.5
LMLP07C7M1R0DTAS	1	±20%	100KHz, 0.25V	6.5	15	13
LMLP07C7M1R5DTAS	1.5	±20%	100KHz, 0.25V	9	12	12
LMLP07C7M2R2DTAS	2.2	±20%	100KHz, 0.25V	13.6	10	10
LMLP07C7M3R3DTAS	3.3	±20%	100KHz, 0.25V	20.9	8	8
LMLP07C7M4R7DTAS	4.7	±20%	100KHz, 0.25V	30.3	7	6.5
LMLP07C7M5R6DTAS	5.6	±20%	100KHz, 0.25V	34.4	7	6
LMLP07C7M6R8DTAS	6.8	±20%	100KHz, 0.25V	44.6	5.5	5.5
LMLP07C7M8R2DTAS	8.2	±20%	100KHz, 0.25V	50.7	5	5
LMLP07C7M100DTAS	10	±20%	100KHz, 0.25V	71.3	4.5	4.5

1011

AVX PN	Inductance (μH)	Tolerance	Test Condition	DCR (Ω)	IsAT (A)	I _{DC} (A)
LMLP1011MR19DTAS	0.19	±20%	100KHz, 0.25V	0.95	90	40
LMLP1011MR36DTAS	0.36	±20%	100KHz, 0.25V	1.4	60	31.5
LMLP1011MR47DTAS	0.47	±20%	100KHz, 0.25V	1.6	38	26
LMLP1011MR56DTAS	0.56	±20%	100KHz, 0.25V	1.8	49	27.5
LMLP1011M1R0DTAS	1	±20%	100KHz, 0.25V	4.1	36	17.5
LMLP1011M1R5DTAS	1.5	±20%	100KHz, 0.25V	5.8	27.5	15
LMLP1011M2R2DTAS	2.2	±20%	100KHz, 0.25V	9	25.6	12
LMLP1011M3R3DTAS	3.3	±20%	100KHz, 0.25V	11.8	18.6	10
LMLP1011M4R7DTAS	4.7	±20%	100KHz, 0.25V	16.5	17	9.5
LMLP1011M5R6DTAS	5.6	±20%	100KHz, 0.25V	19.3	16	8.5
LMLP1011M6R8DTAS	6.8	±20%	100KHz, 0.25V	23.3	13.5	8
LMLP1011M100DTAS	10	±20%	100KHz, 0.25V	36.5	12	6.8
LMLP1011M150DTAS	15	±20%	100KHz, 0.25V	65	7	3.5
LMLP1011M220DTAS	22	±20%	100KHz, 0.25V	120	3	2
LMLP1011M330DTAS	33	±20%	100KHz, 0.25V	200	2.8	1.8
LMLP1011M470DTAS	47	±20%	100KHz, 0.25V	210	3	1.2

13A3

AVX PN	Inductance (μH)	Tolerance	Test Condition	DCR (Ω)	IsAT (A)	I _{DC} (A)
LMLP13A3MR10DTAS	0.1	±20%	100KHz, 0.25V	0.96	84	43
LMLP13A3MR15DTAS	0.15	±20%	100KHz, 0.25V	1.2	75	41
LMLP13A3MR22DTAS	0.22	±20%	100KHz, 0.25V	1.3	65	38.5
LMLP13A3MR33DTAS	0.33	±20%	100KHz, 0.25V	1.5	62	36.5
LMLP13A3MR47DTAS	0.47	±20%	100KHz, 0.25V	2	55	32
LMLP13A3MR60DTAS	0.6	±20%	100KHz, 0.25V	2.2	51	29
LMLP13A3MR68DTAS	0.68	±20%	100KHz, 0.25V	2.5	49	28
LMLP13A3MR82DTAS	0.82	±20%	100KHz, 0.25V	3	44	25
LMLP13A3M1R0DTAS	1	±20%	100KHz, 0.25V	3.5	40	24
LMLP13A3M1R5DTAS	1.5	±20%	100KHz, 0.25V	5.5	35	19
LMLP13A3M1R8DTAS	1.8	±20%	100KHz, 0.25V	7	30	16.5
LMLP13A3M2R2DTAS	2.2	±20%	100KHz, 0.25V	8	29	16
LMLP13A3M3R3DTAS	3.3	±20%	100KHz, 0.25V	12	27	12
LMLP13A3M4R7DTAS	4.7	±20%	100KHz, 0.25V	15	24	10
LMLP13A3M5R6DTAS	5.6	±20%	100KHz, 0.25V	19	19	9.5
LMLP13A3M6R8DTAS	6.8	±20%	100KHz, 0.25V	22	18	9
LMLP13A3M8R2DTAS	8.2	±20%	100KHz, 0.25V	28	16	8.5
LMLP13A3M100DTAS	10	±20%	100KHz, 0.25V	34	14	7

I_{SAT}: The current that causes an inductance drop of approximately 25%.

I_{DC}: DC Current that causes an approximate ΔT of 40°C.



LMax Low Profile/High Current Power Inductor



LMLP Series – Style D

1313

AVX PN	Inductance (μH)	Tolerance	Test Condition	DCR (Ω)	IsAT (A)	I _{DC} (A)
LMLP1313MR10DTAS	0.1	±20%	100KHz, 0.25V	6	118	55
LMLP1313MR22DTAS	0.22	±20%	100KHz, 0.25V	0.8	110	51
LMLP1313MR33DTAS	0.33	±20%	100KHz, 0.25V	1.1	80	42
LMLP1313MR47DTAS	0.47	±20%	100KHz, 0.25V	1.3	65	38
LMLP1313MR56DTAS	0.56	±20%	100KHz, 0.25V	1.5	55	36
LMLP1313MR68DTAS	0.68	±20%	100KHz, 0.25V	1.7	54	34
LMLP1313MR82DTAS	0.82	±20%	100KHz, 0.25V	2.3	53	31
LMLP1313M1R0DTAS	1	±20%	100KHz, 0.25V	2.5	50	29
LMLP1313M1R5DTAS	1.5	±20%	100KHz, 0.25V	4.1	48	23
LMLP1313M1R8DTAS	1.8	±20%	100KHz, 0.25V	4.9	40	19
LMLP1313M2R2DTAS	2.2	±20%	100KHz, 0.25V	5.5	32	20
LMLP1313M3R3DTAS	3.3	±20%	100KHz, 0.25V	9.2	32	15
LMLP1313M4R7DTAS	4.7	±20%	100KHz, 0.25V	15	27	12
LMLP1313M5R6DTAS	5.6	±20%	100KHz, 0.25V	16.5	22	11.5
LMLP1313M6R8DTAS	6.8	±20%	100KHz, 0.25V	18.5	21	11
LMLP1313M7R8DTAS	7.8	±20%	100KHz, 0.25V	20.5	18	10
LMLP1313M8R2DTAS	8.2	±20%	100KHz, 0.25V	22.5	18	9.5
LMLP1313M100DTAS	10	±20%	100KHz, 0.25V	25.5	16	9

13B3

AVX PN	Inductance (μH)	Tolerance	Test Condition	DCR (Ω)	IsAT (A)	I _{DC} (A)
LMLP13B3MR10DTAS	0.1	±20%	100KHz, 0.25V	0.5	120	60
LMLP13B3MR15DTAS	0.15	±20%	100KHz, 0.25V	0.6	118	55
LMLP13B3MR22DTAS	0.22	±20%	100KHz, 0.25V	0.7	112	53
LMLP13B3MR30DTAS	0.3	±20%	100KHz, 0.25V	0.8	72	48
LMLP13B3MR33DTAS	0.33	±20%	100KHz, 0.25V	0.9	65	46
LMLP13B3MR40DTAS	0.4	±20%	100KHz, 0.25V	1	64	44
LMLP13B3MR47DTAS	0.47	±20%	100KHz, 0.25V	1.2	63	41
LMLP13B3MR56DTAS	0.56	±20%	100KHz, 0.25V	1.4	62	37
LMLP13B3MR68DTAS	0.68	±20%	100KHz, 0.25V	1.6	60	35
LMLP13B3MR82DTAS	0.82	±20%	100KHz, 0.25V	1.9	50	33
LMLP13B3M1R0DTAS	1	±20%	100KHz, 0.25V	2	49	32
LMLP13B3M1R2DTAS	1.2	±20%	100KHz, 0.25V	2.5	48	30
LMLP13B3M1R5DTAS	1.5	±20%	100KHz, 0.25V	3	45	27
LMLP13B3M1R8DTAS	1.8	±20%	100KHz, 0.25V	3.2	41	24
LMLP13B3M2R2DTAS	2.2	±20%	100KHz, 0.25V	4.2	40	22
LMLP13B3M3R3DTAS	3.3	±20%	100KHz, 0.25V	6.8	35	18
LMLP13B3M4R7DTAS	4.7	±20%	100KHz, 0.25V	8.7	32	13.5
LMLP13B3M5R6DTAS	5.6	±20%	100KHz, 0.25V	10	32	13.5
LMLP13B3M6R8DTAS	6.8	±20%	100KHz, 0.25V	14	16.5	11.5
LMLP13B3M8R2DTAS	8.2	±20%	100KHz, 0.25V	15.5	16	10.5
LMLP13B3M100DTAS	10	±20%	100KHz, 0.25V	17.2	15.5	10

I_{SAT}: The current that causes an inductance drop of approximately 25%.

I_{DC}: DC Current that causes an approximate ΔT of 40°C.

LMax Low Profile/High Current Power Inductor



LMLP Series – Style D

GENERAL CHARACTERISTICS

Items	Requirement	Test Methods		
Solderability	More than 90% of the terminal electrode should be covered with solder.	230±5°C for 4±1 seconds		
Solder Heat Resistance	Inductance value must remain within 20% of initial value. No disconnection or short circuit. No change in appearance.	260±5°C for 4±1 seconds		
Heat Resistance	Inductance value must remain within 20% of initial value. No disconnection or short circuit. No change in appearance.	Temperature: 125±5°C Time: 500 hours Tested after 2 hours at room temperature		
Cold Resistance	Inductance value must remain within 20% of initial value. No disconnection or short circuit. No change in appearance.	Temperature: -40±5°C Time: 500 hours Tested after 2 hours at room temperature		
Thermal Shock	Inductance value must remain within 20% of initial value. No disconnection or short circuit. No change in appearance.	One Cycle		
		Step	Temperature (°C)	Time (min.)
		1	-40±5°C	30
		2	Room Temperature	3
		3	125±5°C	30
4	Room Temperature	3		
Humidity Resistance	Inductance value must remain within 20% of initial value. No disconnection or short circuit. No change in appearance.	Temperature: 40±2°C at 90~95% relative humidity .		
		Time: 500 Hours		
		Tested after 2 hours at room temperature		
Vibration Test	Inductance value must remain within ±5% of initial value. No change in appearance	After 1 hour of vibrations testing, in each of three orientations at 10Hz, then increase to 55Hz, then decrease to 10Hz with 1.52mm P-P amplitudes.		

LMax Low Profile/High Current Power Inductor



LMLP Series – Style D

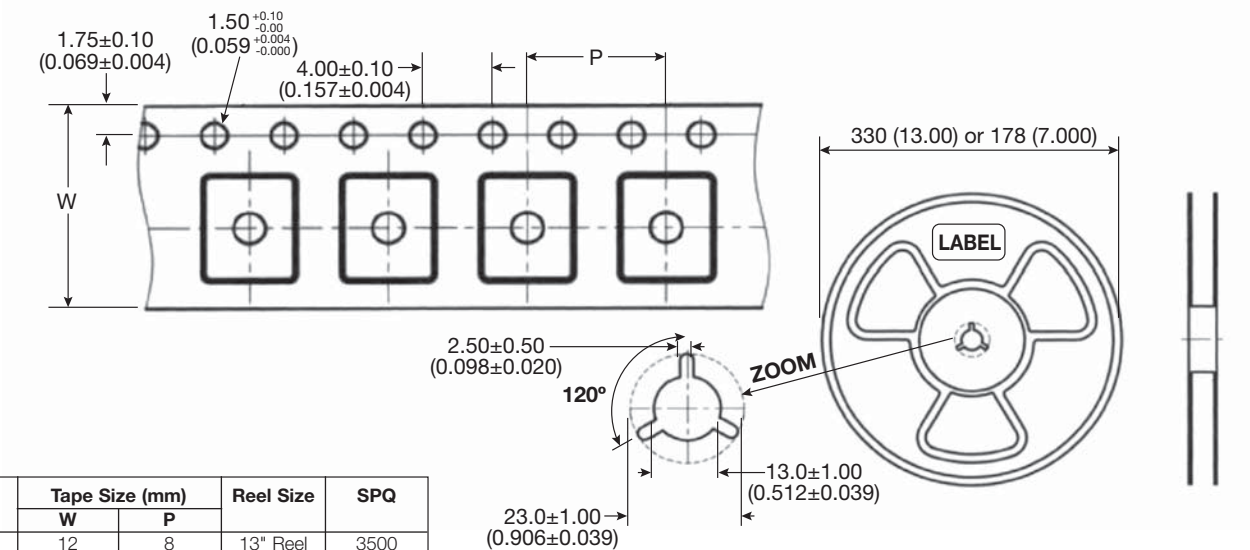
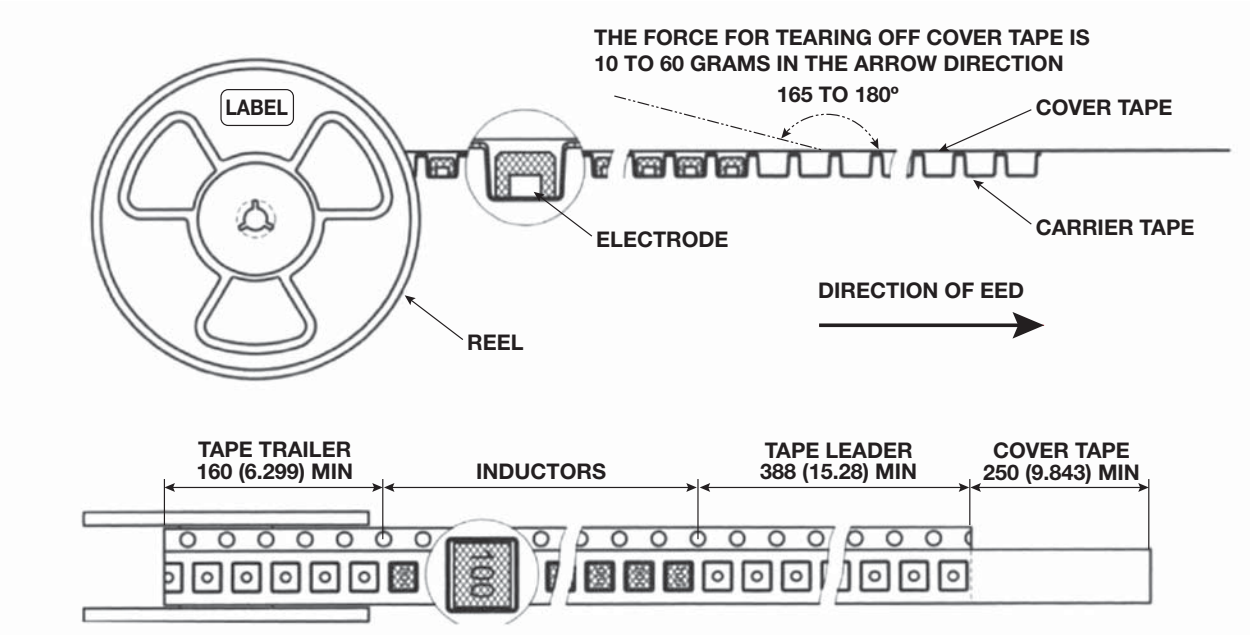

Size Code	Tape Size (mm)		Reel Size	SPQ
	W	P		
0405	12	8	13" Reel	3500
05A6	12	8	13" Reel	3000
0506	12	8	13" Reel	2500
0707	16	12	13" Reel	2000
07A7	16	12	13" Reel	2000
07B7	16	12	13" Reel	1500
07C7	16	12	13" Reel	800
1011	24	16	13" Reel	1000
13A3	24	16	13" Reel	1000
1313	24	16	13" Reel	500
13B3	24	16	13" Reel	500



LMax Low Profile Power Inductor



LMLP Series – Style M

FEATURES

- Very low profile.
- Constructed enclosed in a rugged to provide optimum pick and place operations.
- High inductance & high current ultra low profile power inductors.

APPLICATIONS

- LCD Televisions
- Personal Computers
- Handheld Communication
- DC/DC Converters, etc.

CHARACTERISTICS

- Rated Current (IDC): The DC current when the inductance becomes 10% lower than its initial value. (Ta=25°C)
- Operating temperature range: -40 ~ +100°C

INDUCTANCE AND RATED CURRENT RANGES

- 0606 1.2 ~ 330μH 2.1 ~ 0.13A
- 06A6 1.2 ~ 100μH 1.8 ~ 0.235A
- 06B6 1.0 ~ 1000μH 2.5 ~ 0.08A
- Electrical specifications at 25°C



DIMENSIONS

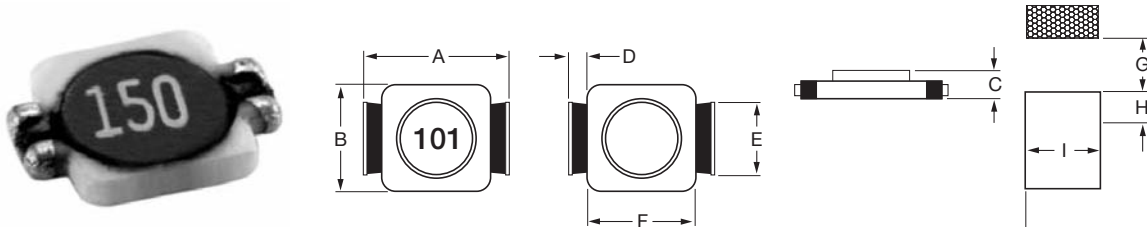

mm (inches)

Type	A max	B ±0.3	C max	D	E	F	G	H	I
0606	6.50 (0.256)	5.30 (0.209)	1.20 (0.047)	0.90 (0.035)	3.00 (0.118)	4.50 (0.177)	4.00 (0.157)	1.50 (0.059)	3.40 (0.134)
06A6	6.50 (0.256)	5.30 (0.209)	1.20 (0.047)	0.90 (0.035)	3.00 (0.118)	4.50 (0.177)	4.00 (0.157)	1.50 (0.059)	3.40 (0.134)
06B6	6.50 (0.256)	5.30 (0.209)	2.00 (0.079)	0.90 (0.035)	3.00 (0.118)	4.50 (0.177)	4.00 (0.157)	1.50 (0.059)	3.40 (0.134)

HOW TO ORDER

LM	LP	0606	M	R04	M	T	A	S
Family	Series	Size	Tolerance	Inductance	Style	Termination	Special	Packaging
LM = Power Inductor	LP = Low Profile	See table	M = 20%	3R9 = 3.900μH 390 = 39.00μH 391 = 390.0μH		T = Sn Plate	A = Standard	S = 13" Reel



LMax Low Profile Power Inductor



LMLP Series – Style M

ELECTRICAL CHARACTERISTICS

0606

Codes	L (μH)	Tolerance	Test Condition	DCR (Ω) max.	I sat (A) max*
1R2	1.2	M	100KHz, 0.1V	0.08	2.1
1R5	1.5	M	100KHz, 0.1V	0.10	1.9
2R2	2.2	M	100KHz, 0.1V	0.12	1.6
3R3	3.3	M	100KHz, 0.1V	0.16	1.3
4R7	4.7	M	100KHz, 0.1V	0.20	1.1
6R8	6.8	M	100KHz, 0.1V	0.32	0.9
100	10	M	100KHz, 0.1V	0.41	0.8
150	15	M	100KHz, 0.1V	0.65	0.65
220	22	M	100KHz, 0.1V	0.85	0.50
330	33	M	100KHz, 0.1V	1.30	0.40
470	47	M	100KHz, 0.1V	1.80	0.35
680	68	M	100KHz, 0.1V	2.50	0.30
101	100	M	100KHz, 0.1V	3.50	0.25
151	150	M	100KHz, 0.1V	6.50	0.18
221	220	M	100KHz, 0.1V	8.50	0.16
331	330	M	100KHz, 0.1V	15.0	0.13

06A6

Codes	L (μH)	Tolerance	Test Condition	DCR (Ω) max.	I sat (A) max*
1R2	1.2	M	100KHz, 0.1V	0.060	1.80
2R2	2.2	M	100KHz, 0.1V	0.125	1.20
3R3	3.3	M	100KHz, 0.1V	0.155	0.96
4R7	4.7	M	100KHz, 0.1V	0.206	0.90
6R8	6.8	M	100KHz, 0.1V	0.240	0.80
100	10	M	100KHz, 0.1V	0.370	0.70
150	15	M	100KHz, 0.1V	0.460	0.60
180	18	M	100KHz, 0.1V	0.580	0.56
220	22	M	100KHz, 0.1V	0.668	0.50
270	27	M	100KHz, 0.1V	0.950	0.45
330	33	M	100KHz, 0.1V	1.100	0.42
390	39	M	100KHz, 0.1V	1.280	0.38
470	47	M	100KHz, 0.1V	1.380	0.34
560	56	M	100KHz, 0.1V	1.700	0.30
680	68	M	100KHz, 0.1V	2.100	0.28
820	82	M	100KHz, 0.1V	2.700	0.26
101	100	M	100KHz, 0.1V	3.100	0.235

06B6

Codes	L (μH)	Tolerance	Test Condition	DCR (Ω) max.	I sat (A) max*
1R0	1.0	M	100KHz, 0.1V	0.04	2.5
1R5	1.5	M	100KHz, 0.1V	0.06	2.2
2R2	2.2	M	100KHz, 0.1V	0.07	1.8
3R3	3.3	M	100KHz, 0.1V	0.10	1.4
4R7	4.7	M	100KHz, 0.1V	0.12	1.2
6R8	6.8	M	100KHz, 0.1V	0.19	1.1
100	10	M	100KHz, 0.1V	0.30	1.0
150	15	M	100KHz, 0.1V	0.40	0.8
220	22	M	100KHz, 0.1V	0.54	0.6
330	33	M	100KHz, 0.1V	0.74	0.5
470	47	M	100KHz, 0.1V	1.10	0.45
680	68	M	100KHz, 0.1V	1.60	0.35
101	100	M	100KHz, 0.1V	2.30	0.30
151	150	M	100KHz, 0.1V	3.20	0.25
221	220	M	100KHz, 0.1V	5.70	0.20
331	330	M	100KHz, 0.1V	8.20	0.16
471	470	M	100KHz, 0.1V	10.8	0.14
681	680	M	100KHz, 0.1V	17.2	0.12
102	1000	M	100KHz, 0.1V	22.6	0.08

*Saturation Current: The DC current when the inductance becomes 10% lower than its initial value. (Ta=25°C)



LMax Low Profile Power Inductor



LMLP Series – Style O

FEATURES

- Very low profile
- High current rating up to 1.4 Amps.
- Density design, small size, and low cost

APPLICATIONS

- Camcorder
- LCD TV
- MP3 Player
- GPS, PDAs
- Portable CDR-W
- Digital Cameras
- DC/DC Converters, etc

CHARACTERISTICS

- Rated Current (IDC): The DC current when the inductance becomes 30% lower than its initial value. (Ta=25°C)
- Operating temperature range: -40 ~ +100°C

INDUCTANCE AND RATED CURRENT RANGES

- 0312 1.0 ~ 68μH 1.40 ~ 0.17A
- Electrical specifications at 25°C



DIMENSIONS

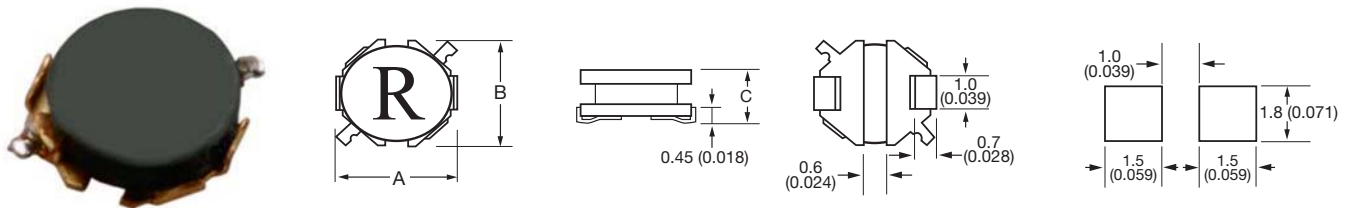

mm (inches)

Type	A	B	C max
0303	3.20 ± 0.30 (0.126 ± 0.012)	3.20 ± 0.30 (0.126 ± 0.012)	1.20 (0.047)

HOW TO ORDER

LM	LP	0303	M	R04	O	T	A	R
Family	Series	Size	Tolerance	Inductance	Style	Termination	Special	Packaging
LM = Power Inductor	LP = Low Profile	0303	M = 20% N = 30%	3R9 = 3.900μH 390 = 39.00μH		T = Sn Plate	A = Standard	R = 7" Reel

ELECTRICAL CHARACTERISTICS

0303						
Codes	L (μH)	Tolerance	Test Condition	DCR (Ω) max.	I sat (A) max*	Marking
1R0	1.0	N	100KHz, 0.1V	0.08	1.40	A
1R8	1.8	N	100KHz, 0.1V	0.11	1.10	C
2R2	2.2	N	100KHz, 0.1V	0.12	1.00	D
2R7	2.7	N	100KHz, 0.1V	0.15	0.95	E
4R7	4.7	N	100KHz, 0.1V	0.28	0.75	H
5R6	5.6	N	100KHz, 0.1V	0.31	0.68	I
6R8	6.8	N	100KHz, 0.1V	0.36	0.62	K
7R5	7.5	N	100KHz, 0.1V	0.39	0.60	L
100	10	M	100KHz, 0.1V	0.43	0.53	M
150	15	M	100KHz, 0.1V	0.72	0.44	O
220	22	M	100KHz, 0.1V	1.18	0.33	R
330	33	M	100KHz, 0.1V	1.90	0.26	T
470	47	M	100KHz, 0.1V	2.45	0.23	V
680	68	M	100KHz, 0.1V	4.20	0.17	X

*Saturation Current: The DC current when the inductance becomes 30% lower than its initial value. (Ta=25°C)



LMax Low Profile Power Inductor



LMLP Series – Style R

FEATURES

- Low profile, low RDC, lower resistance and high current handling capacities
- Flat bottom surface ensures secure, reliable surface mounting
- Magnetically shielded structure allows high-density mounting configurations

APPLICATIONS

- PDA, DSC, PDA and Other Electronic Equipments
- Hard Disk Drives
- Low Profile/ Low Resistance Specifically Suitable For Portable Telephones

INDUCTANCE AND RATED CURRENT RANGES

- 0303 1.2 ~ 47 μ H 1.40 ~ 0.18A
- 03A3 (R) 1.0 ~ 18 μ H 1.40 ~ 0.30A
- 03A3 (H) 0.47 ~ 100 μ H 3.40 ~ 0.24A
- 03B3 (R) 1.0 ~ 27 μ H 1.36 ~ 0.22A
- 03B3 (H) 1.0 ~ 33 μ H 3.00 ~ 0.47A
- 0404 1.0 ~ 33 μ H 3.00 ~ 0.42A
- 04A4 0.5 ~ 47 μ H 3.90 ~ 0.34A
- 04B4 1.0 ~ 100 μ H 3.20 ~ 0.26A
- Test equipment:
L: HP4284A Precision LCR meter
DCR: Milli-ohm meter
- Electrical specifications at 25°C



CHARACTERISTICS

- Saturation Rated Current(I_{DC}): The current when the inductance becomes 10% or 35% lower than its initial value.
- Temperature Rise Current(I_{rms}): For a 25% rise above 25°C ambient.
- Operating temperature range: -25 ~ 105°C

DIMENSIONS

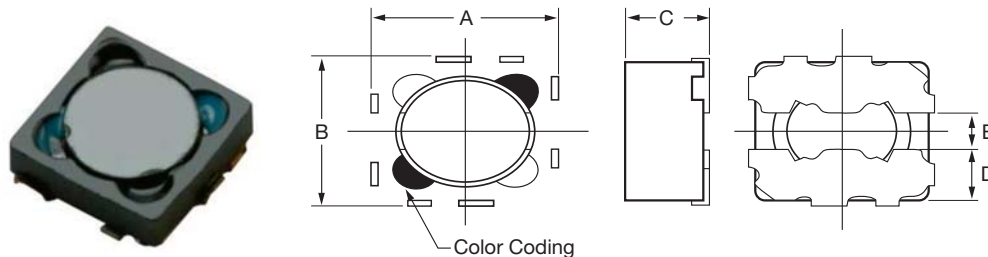

mm (inches)

Type	A	B	C max	D	E	H	I	J
0303	3.20 ± 0.20 (0.126 ± 0.008)	3.20 ± 0.20 (0.126 ± 0.008)	1.05 (0.041)	1.10 (0.043)	0.80 (0.031)	3.60 (0.142)	1.40 (0.055)	0.80 (0.031)
03A3 / 03A3 (R) / 03A3 (H)	3.20 ± 0.20 (0.126 ± 0.008)	3.20 ± 0.20 (0.126 ± 0.008)	1.60 (0.063)	1.10 (0.043)	0.80 (0.031)	3.60 (0.142)	1.40 (0.055)	0.80 (0.031)
03B3 (R) / 03B3 (H)	3.20 ± 0.20 (0.126 ± 0.008)	3.20 ± 0.20 (0.126 ± 0.008)	1.80 (0.071)	1.10 (0.043)	0.80 (0.031)	3.60 (0.142)	1.40 (0.055)	0.80 (0.031)
0404	4.20 ± 0.20 (0.165 ± 0.008)	4.20 ± 0.20 (0.165 ± 0.008)	1.25 (0.049)	1.30 (0.051)	1.40 (0.055)	4.60 (0.181)	1.60 (0.063)	1.40 (0.055)
04A4	4.20 ± 0.20 (0.165 ± 0.008)	4.20 ± 0.20 (0.165 ± 0.008)	1.60 (0.063)	1.30 (0.051)	1.40 (0.055)	4.60 (0.181)	1.60 (0.063)	1.40 (0.055)
04B4	4.20 ± 0.20 (0.165 ± 0.008)	4.20 ± 0.20 (0.165 ± 0.008)	1.80 (0.071)	1.30 (0.051)	1.40 (0.055)	4.60 (0.181)	1.60 (0.063)	1.40 (0.055)

HOW TO ORDER

LM	LP	0303	M	R04	R	T	A	R
Family	Series	Size	Tolerance	Inductance	Style	Termination	Special	Packaging
LM = Power Inductor	LP = Low Profile	0303 = 3x3xh 03A3 = 3x3xA(h) (h = see catalog)	M = 20% N = 30%	3R9 = 3.900 μ H 390 = 39.00 μ H 391 = 390.0 μ H	T = Sn Plate	A = Standard R = Low Resistance H = High Current	R = 7" Reel	



LMax Low Profile Power Inductor



LMLP Series – Style R

ELECTRICAL CHARACTERISTICS

0303

Codes	L (uH)	Tolerance	Test Condition	DCR (Ω) Typ.	I sat (A) Typ.*		I rms (A) Typ.	Color Code
					L drop 10%	L drop 35%		
1R2	1.2	N,M	1KHz, 1V	0.070	1.00	1.40	1.50	Black
1R5	1.5	N,M	1KHz, 1V	0.087	1.00	1.36	1.40	Brown
1R8	1.8	N,M	1KHz, 1V	0.097	0.90	1.24	1.35	Red
2R2	2.2	N,M	1KHz, 1V	0.136	0.80	0.97	1.10	Orange
2R7	2.7	N,M	1KHz, 1V	0.127	0.76	0.94	1.10	Yellow
3R3	3.3	N,M	1KHz, 1V	0.175	0.68	0.88	1.00	Green
3R9	3.9	N,M	1KHz, 1V	0.200	0.62	0.84	0.90	Blue
4R7	4.7	N,M	1KHz, 1V	0.274	0.60	0.82	0.85	Violet
5R6	5.6	N,M	1KHz, 1V	0.319	0.54	0.72	0.75	Gray
6R8	6.8	N,M	1KHz, 1V	0.330	0.46	0.60	0.70	White
8R2	8.2	N,M	1KHz, 1V	0.420	0.44	0.58	0.65	Black
100	10	M	1KHz, 1V	0.470	0.42	0.54	0.60	Brown
120	12	M	1KHz, 1V	0.675	0.32	0.44	0.55	Red
150	15	M	1KHz, 1V	0.800	0.30	0.40	0.50	Orange
180	18	M	1KHz, 1V	0.890	0.30	0.38	0.45	Yellow
220	22	M	1KHz, 1V	1.110	0.26	0.32	0.40	Green
270	27	M	1KHz, 1V	1.600	0.24	0.30	0.34	Black
330	33	M	1KHz, 1V	1.600	0.22	0.28	0.34	Blue
470	47	M	1KHz, 1V	2.430	0.18	0.22	0.24	Black

03A3R

Codes	L (uH)	Tolerance	Test Condition	DCR (Ω) Typ.	I sat (A) Typ.*		I rms (A) Typ.	Color Code
					L drop 10%	L drop 35%		
1R0	1.0	N,M	1KHz, 1V	0.038	1.04	1.40	1.80	Green
1R2	1.2	N,M	1KHz, 1V	0.041	1.00	1.30	1.74	Blue
1R5	1.5	N,M	1KHz, 1V	0.046	0.94	1.22	1.70	Violet
1R8	1.8	N,M	1KHz, 1V	0.058	0.92	1.16	1.64	Gray
2R2	2.2	N,M	1KHz, 1V	0.066	0.88	1.10	1.60	White
2R7	2.7	N,M	1KHz, 1V	0.070	0.74	0.93	1.45	Green
3R3	3.3	N,M	1KHz, 1V	0.091	0.68	0.90	1.24	Blue
3R9	3.9	N,M	1KHz, 1V	0.115	0.62	0.82	1.12	Violet
4R7	4.7	N,M	1KHz, 1V	0.132	0.60	0.74	1.10	Gray
5R6	5.6	N,M	1KHz, 1V	0.156	0.58	0.70	1.06	White
6R8	6.8	N,M	1KHz, 1V	0.166	0.42	0.62	1.00	Green
8R2	8.2	N,M	1KHz, 1V	0.230	0.40	0.58	0.90	Blue
100	10	M	1KHz, 1V	0.244	0.38	0.50	0.80	Violet
120	12	M	1KHz, 1V	0.324	0.36	0.44	0.70	Gray
150	15	M	1KHz, 1V	0.370	0.36	0.42	0.70	White
180	18	M	1KHz, 1V	0.489	0.30	0.38	0.62	Green

LMax Low Profile Power Inductor



LMLP Series – Style R

03A3H

Codes	L (uH)	Tolerance	Test Condition	DCR (Ω) Typ.	I sat (A) Typ.*		I rms (A) Typ.	Color Code
					L drop 10%	L drop 35%		
R47	0.47	N,M	1KHz, 1V	0.040	3.00	3.40	2.20	Black
1R0	1.0	N,M	1KHz, 1V	0.049	2.60	3.00	2.00	Black
1R2	1.2	N,M	1KHz, 1V	0.083	2.30	2.50	1.90	Brown
1R5	1.5	N,M	1KHz, 1V	0.090	2.10	2.50	1.50	Brown
2R2	2.2	N,M	1KHz, 1V	0.090	1.80	2.10	1.28	Red
3R3	3.3	N,M	1KHz, 1V	0.149	1.50	1.72	1.10	Orange
3R9	3.9	N,M	1KHz, 1V	0.158	1.40	1.56	1.02	Yellow
4R7	4.7	N,M	1KHz, 1V	0.197	1.30	1.50	0.96	Black
5R6	5.6	N,M	1KHz, 1V	0.232	1.20	1.30	0.94	Black
6R8	6.8	N,M	1KHz, 1V	0.266	1.10	1.30	0.84	Brown
100	10	M	1KHz, 1V	0.403	0.94	1.10	0.74	Red
150	15	M	1KHz, 1V	0.567	0.76	0.86	0.60	Orange
220	22	M	1KHz, 1V	0.905	0.60	0.68	0.46	Yellow
330	33	M	1KHz, 1V	1.486	0.44	0.48	0.40	Black
470	47	M	1KHz, 1V	1.814	0.40	0.44	0.26	Brown
680	68	M	1KHz, 1V	3.520	0.29	0.33	0.26	Orange
101	100	M	1KHz, 1V	3.840	0.24	0.28	0.24	Black

03B3R

Codes	L (uH)	Tolerance	Test Condition	DCR (Ω) Typ.	I sat (A) Typ.*		I rms (A) Typ.	Color Code
					L drop 10%	L drop 35%		
1R0	1.0	N,M	1KHz, 1V	0.038	0.96	1.36	1.80	Green
1R2	1.2	N,M	1KHz, 1V	0.041	0.94	1.22	1.76	Blue
1R5	1.5	N,M	1KHz, 1V	0.048	0.90	1.14	1.70	Violet
1R8	1.8	N,M	1KHz, 1V	0.052	0.84	1.04	1.68	Gray
2R2	2.2	N,M	1KHz, 1V	0.055	0.75	0.95	1.64	White
2R7	2.7	N,M	1KHz, 1V	0.060	0.68	0.90	1.46	Green
3R3	3.3	N,M	1KHz, 1V	0.078	0.60	0.80	1.40	Blue
3R9	3.9	N,M	1KHz, 1V	0.090	0.58	0.80	1.22	Violet
4R7	4.7	N,M	1KHz, 1V	0.099	0.54	0.74	1.20	Gray
5R6	5.6	N,M	1KHz, 1V	0.110	0.50	0.66	1.12	White
6R8	6.8	N,M	1KHz, 1V	0.120	0.48	0.60	1.06	Green
8R2	8.2	N,M	1KHz, 1V	0.168	0.40	0.54	0.90	Blue
100	10	M	1KHz, 1V	0.190	0.36	0.46	0.88	Violet
120	12	M	1KHz, 1V	0.222	0.32	0.46	0.80	Gray
150	15	M	1KHz, 1V	0.285	0.30	0.40	0.72	White
180	18	M	1KHz, 1V	0.350	0.28	0.38	0.66	Green
220	22	M	1KHz, 1V	0.440	0.24	0.32	0.50	Blue
270	27	M	1KHz, 1V	0.490	0.22	0.28	0.42	Violet

03B3H

Codes	L (uH)	Tolerance	Test Condition	DCR (Ω) Typ.	I sat (A) Typ.*		I rms (A) Typ.	Color Code
					L drop 10%	L drop 35%		
1R0	1.0	N,M	1KHz, 1V	0.045	2.60	3.00	2.00	Black
1R8	1.8	N,M	1KHz, 1V	0.078	2.00	2.30	1.76	Brown
2R2	2.2	N,M	1KHz, 1V	0.090	1.80	2.14	1.44	Red
3R3	3.3	N,M	1KHz, 1V	0.103	1.50	1.80	1.10	Orange
3R9	3.9	N,M	1KHz, 1V	0.115	1.50	1.78	1.05	Yellow
4R7	4.7	N,M	1KHz, 1V	0.152	1.40	1.60	1.00	Black
6R8	6.8	N,M	1KHz, 1V	0.223	1.20	1.40	0.95	Brown
100	10	M	1KHz, 1V	0.360	0.92	1.02	0.78	Red
120	12	M	1KHz, 1V	0.410	0.84	0.98	0.68	Orange
150	15	M	1KHz, 1V	0.622	0.80	0.90	0.62	Yellow
220	22	M	1KHz, 1V	0.750	0.64	0.74	0.45	Black
330	33	M	1KHz, 1V	1.125	0.47	0.52	0.42	Brown



LMax Low Profile Power Inductor



LMLP Series – Style R

0404

Codes	L (uH)	Tolerance	Test Condition	DCR (Ω) Typ.	I sat (A) Typ.*		I rms (A) Typ.	Color Code
					L drop 10%	L drop 35%		
1R0	1.0	N,M	1KHz, 1V	0.045	2.30	3.00	2.00	Black
1R2	1.2	N,M	1KHz, 1V	0.048	2.20	2.80	1.90	Brown
1R5	1.5	N,M	1KHz, 1V	0.055	1.90	2.40	1.80	Red
1R8	1.8	N,M	1KHz, 1V	0.073	1.80	2.30	1.75	Orange
2R2	2.2	N,M	1KHz, 1V	0.083	1.70	2.10	1.75	Yellow
2R7	2.7	N,M	1KHz, 1V	0.109	1.40	1.70	1.44	Green
3R3	3.3	N,M	1KHz, 1V	0.118	1.30	1.70	1.40	Blue
3R9	3.9	N,M	1KHz, 1V	0.143	1.26	1.60	1.30	Violet
4R7	4.7	N,M	1KHz, 1V	0.159	1.24	1.58	1.20	Gray
5R6	5.6	N,M	1KHz, 1V	0.213	1.00	1.30	1.00	White
6R8	6.8	N,M	1KHz, 1V	0.224	1.00	1.30	0.96	Black
8R2	8.2	N,M	1KHz, 1V	0.252	0.92	1.14	0.94	Brown
100	10	M	1KHz, 1V	0.327	0.86	1.06	0.90	Red
120	12	M	1KHz, 1V	0.363	0.80	0.98	0.82	Orange
150	15	M	1KHz, 1V	0.516	0.60	0.80	0.64	Yellow
180	18	M	1KHz, 1V	0.625	0.56	0.76	0.60	Green
220	22	M	1KHz, 1V	0.732	0.46	0.64	0.52	Blue
330	33	M	1KHz, 1V	1.165	0.42	0.50	0.42	Violet

04A4

Codes	L (uH)	Tolerance	Test Condition	DCR (Ω) Typ.	I sat (A) Typ.*		I rms (A) Typ.	Color Code
					L drop 10%	L drop 35%		
R50	0.5	N	1KHz, 1V	0.035	3.10	3.90	2.50	Black
1R0	1.0	N,M	1KHz, 1V	0.040	2.30	3.00	2.40	Black
1R2	1.2	N,M	1KHz, 1V	0.043	2.20	2.80	2.34	Brown
1R5	1.5	N,M	1KHz, 1V	0.050	2.00	2.60	2.30	Red
1R8	1.8	N,M	1KHz, 1V	0.055	1.66	2.30	2.10	Orange
2R2	2.2	N,M	1KHz, 1V	0.071	1.60	2.20	2.00	Yellow
2R7	2.7	N,M	1KHz, 1V	0.078	1.40	2.00	1.60	Green
3R3	3.3	N,M	1KHz, 1V	0.087	1.34	2.00	1.60	Blue
3R9	3.9	N,M	1KHz, 1V	0.100	1.20	1.80	1.50	Violet
4R7	4.7	N,M	1KHz, 1V	0.137	1.14	1.60	1.40	Gray
5R6	5.6	N,M	1KHz, 1V	0.147	1.06	1.46	1.20	White
6R8	6.8	N,M	1KHz, 1V	0.170	1.00	1.40	1.15	Black
8R2	8.2	N,M	1KHz, 1V	0.195	0.94	1.28	1.10	Brown
100	10	M	1KHz, 1V	0.228	0.90	1.16	1.02	Red
120	12	M	1KHz, 1V	0.275	0.88	1.08	0.90	Orange
150	15	M	1KHz, 1V	0.340	0.64	0.86	0.72	Yellow
180	18	M	1KHz, 1V	0.380	0.60	0.82	0.68	Green
220	22	M	1KHz, 1V	0.495	0.54	0.74	0.65	Blue
270	27	M	1KHz, 1V	0.735	0.50	0.70	0.55	Violet
330	33	M	1KHz, 1V	0.890	0.46	0.58	0.48	Gray
390	39	M	1KHz, 1V	1.000	0.40	0.56	0.42	White
470	47	M	1KHz, 1V	1.150	0.34	0.52	0.35	Black

LMax Low Profile Power Inductor



LMLP Series – Style R

04B4

Codes	L (uH)	Tolerance	Test Condition	DCR (Ω) Typ.	I sat (A) Typ.*		I rms (A) Typ.	Color Code
					L drop 10%	L drop 35%		
1R0	1.0	N,M	1KHz, 1V	0.038	2.60	3.20	2.40	Black
1R2	1.2	N,M	1KHz, 1V	0.044	2.40	3.00	2.20	Brown
1R5	1.5	N,M	1KHz, 1V	0.050	2.20	2.70	2.20	Red
1R8	1.8	N,M	1KHz, 1V	0.045	1.90	2.40	2.00	Orange
2R2	2.2	N,M	1KHz, 1V	0.062	1.80	2.20	1.90	Yellow
2R7	2.7	N,M	1KHz, 1V	0.068	1.70	2.10	1.80	Green
3R3	3.3	N,M	1KHz, 1V	0.080	1.50	1.88	1.65	Blue
3R9	3.9	N,M	1KHz, 1V	0.084	1.40	1.80	1.56	Violet
4R7	4.7	N,M	1KHz, 1V	0.099	1.22	1.46	1.40	Gray
5R6	5.6	N,M	1KHz, 1V	0.110	1.16	1.48	1.30	White
6R8	6.8	N,M	1KHz, 1V	0.128	1.02	1.26	1.20	Black
8R2	8.2	N,M	1KHz, 1V	0.146	1.000	1.24	1.15	Brown
100	10	M	1KHz, 1V	0.165	0.90	1.10	1.05	Red
120	12	M	1KHz, 1V	0.254	0.84	1.00	0.80	Orange
150	15	M	1KHz, 1V	0.320	0.74	0.88	0.72	Yellow
180	18	M	1KHz, 1V	0.360	0.70	0.84	0.68	Green
220	22	M	1KHz, 1V	0.418	0.60	0.74	0.65	Blue
270	27	M	1KHz, 1V	0.450	0.56	0.70	0.60	Violet
330	33	M	1KHz, 1V	0.620	0.46	0.58	0.58	Gray
390	39	M	1KHz, 1V	0.650	0.45	0.56	0.48	White
470	47	M	1KHz, 1V	0.790	0.43	0.52	0.45	Black
560	56	M	1KHz, 1V	0.862	0.38	0.48	0.40	Brown
680	68	M	1KHz, 1V	1.000	0.30	0.40	0.36	Red
101	100	M	1KHz, 1V	1.380	0.26	0.32	0.36	Yellow

AMERICAS

AVX Greenville, SC
Tel: 864-967-2150

AVX Northwest, WA
Tel: 360-699-8746

AVX Midwest, IN
Tel: 317-861-9184

AVX Mid/Pacific, CA
Tel: 408-988-4900

AVX Northeast, MA
Tel: 617-479-0345

AVX Southwest, CA
Tel: 949-859-9509

AVX Canada
Tel: 905-238-3151

AVX South America
Tel: +55-11-4688-1960

EUROPE

AVX Limited, England
Tel: +44-1276-697000

AVX S.A.S., France
Tel: +33-1-69-18-46-00

AVX GmbH, Germany
Tel: +49-0811-95949-0

AVX SRL, Italy
Tel: +39-02-614-571

AVX Czech Republic
Tel: +420-57-57-57-521

AVX/ELCO UK
Tel: +44-1638-675000

ELCO Europe GmbH
Tel: +49-2741-299-0

AVX S.A., Spain
Tel: +34-91-63-97-197

AVX Benelux
Tel: +31-187-489-337

ASIA-PACIFIC

**AVX/Kyocera (S) Pte Ltd.,
Singapore**
Tel: +65-6286-7555

**AVX/Kyocera, Asia, Ltd.,
Hong Kong**
Tel: +852-2363-3303

**AVX/Kyocera Yuhan Hoesa,
South Korea**
Tel: +82-2785-6504

**AVX/Kyocera HK Ltd.,
Taiwan**
Tel: +886-2-2656-0258

**AVX/Kyocera (M) Sdn Bhd,
Malaysia**
Tel: +60-4228-1190

**AVX/Kyocera International
Trading Co. Ltd.,
Shanghai**
Tel: +86-21-3255 1933

**AVX/Kyocera Asia Ltd.,
Shenzen**
Tel: +86-755-3336-0615

**AVX/Kyocera International
Trading Co. Ltd.,
Beijing**
Tel: +86-10-6588-3528

**AVX/Kyocera India
Liaison Office**
Tel: +91-80-6450-0715

ASIA-KED

(KYOCERA Electronic Devices)

KED Hong Kong Ltd.
Tel: +852-2305-1080/1223

**KED Hong Kong Ltd.
Shenzen**
Tel: +86-755-3398-9600

**KED Company Ltd.
Shanghai**
Tel: +86-21-3255-1833

**KED Hong Kong Ltd.
Beijing**
Tel: +86-10-5869-4655

KED Taiwan Ltd.
Tel: +886-2-2950-0268

**KED Korea Yuhan Hoesa,
South Korea**
Tel: +82-2-783-3604/6126

**KED (S) Pte Ltd.
Singapore**
Tel: +65-6509-0328

**Kyocera Corporation
Japan**
Tel: +81-75-604-3449

Contact:



Компания «Океан Электроники» предлагает заключение долгосрочных отношений при поставках импортных электронных компонентов на взаимовыгодных условиях!

Наши преимущества:

- Поставка оригинальных импортных электронных компонентов напрямую с производств Америки, Европы и Азии, а так же с крупнейших складов мира;
- Широкая линейка поставок активных и пассивных импортных электронных компонентов (более 30 млн. наименований);
- Поставка сложных, дефицитных, либо снятых с производства позиций;
- Оперативные сроки поставки под заказ (от 5 рабочих дней);
- Экспресс доставка в любую точку России;
- Помощь Конструкторского Отдела и консультации квалифицированных инженеров;
- Техническая поддержка проекта, помощь в подборе аналогов, поставка прототипов;
- Поставка электронных компонентов под контролем ВП;
- Система менеджмента качества сертифицирована по Международному стандарту ISO 9001;
- При необходимости вся продукция военного и аэрокосмического назначения проходит испытания и сертификацию в лаборатории (по согласованию с заказчиком);
- Поставка специализированных компонентов военного и аэрокосмического уровня качества (Xilinx, Altera, Analog Devices, Intersil, Interpoint, Microsemi, Actel, Aeroflex, Peregrine, VPT, Syfer, Eurofarad, Texas Instruments, MS Kennedy, Miteq, Cobham, E2V, MA-COM, Hittite, Mini-Circuits, General Dynamics и др.);

Компания «Океан Электроники» является официальным дистрибьютором и эксклюзивным представителем в России одного из крупнейших производителей разъемов военного и аэрокосмического назначения «JONHON», а так же официальным дистрибьютором и эксклюзивным представителем в России производителя высокотехнологичных и надежных решений для передачи СВЧ сигналов «FORSTAR».



JONHON

«JONHON» (основан в 1970 г.)

Разъемы специального, военного и аэрокосмического назначения:

(Применяются в военной, авиационной, аэрокосмической, морской, железнодорожной, горно- и нефтедобывающей отраслях промышленности)

«FORSTAR» (основан в 1998 г.)

ВЧ соединители, коаксиальные кабели,
кабельные сборки и микроволновые компоненты:

(Применяются в телекоммуникациях гражданского и специального назначения, в средствах связи, РЛС, а так же военной, авиационной и аэрокосмической отраслях промышленности).



Телефон: 8 (812) 309-75-97 (многоканальный)

Факс: 8 (812) 320-03-32

Электронная почта: ocean@oceanchips.ru

Web: <http://oceanchips.ru/>

Адрес: 198099, г. Санкт-Петербург, ул. Калинина, д. 2, корп. 4, лит. А