

GP2S60

SMT, Detecting Distance : 0.5mm Phototransistor Output, Compact Reflective Photointerrupter



■ Description

GP2S60 is a compact-package, phototransistor output, reflective photointerrupter, with emitter and detector facing the same direction in a molding that provides non-contact sensing. The compact package series is a result of unique technology, combining transfer and injection molding, that also blocks visible light to minimize false detection.

This photointerrupter can be ordered in different CTR ranks, and has a thin, leadless (T&R) package, suitable for reflow soldering.

■ Features

1. Reflective with Phototransistor Output
2. Highlights :
 - Compact Size
 - Surface Mount Type (SMT), reflow soldering, with gullwing leads
 - Tape and Reel (T&R) 1 000 pcs per reel
3. Key Parameters :
 - Optimal Sensing Distance : 0.7mm
 - Package : 4×3×1.7mm
 - Visible light cut resin to prevent
4. Lead free and RoHS directive compliant

■ Agency approvals/Compliance

1. Compliant with RoHS directive

■ Applications

1. Detection of object presence or motion.
2. Any application, which production is migrating to 100% surface mount components.
3. Example : printer, optical storage

Notice The content of data sheet is subject to change without prior notice.
In the absence of confirmation by device specification sheets, SHARP takes no responsibility for any defects that may occur in equipment using any SHARP devices shown in catalogs, data books, etc. Contact SHARP in order to obtain the latest device specification sheets before using any SHARP device.

■ Internal Connection Diagram

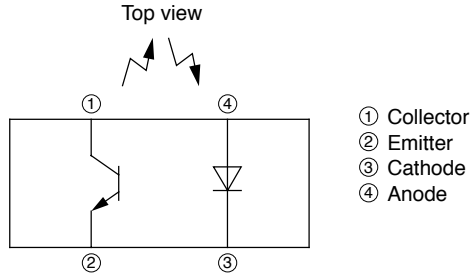

■ Outline Dimensions

(Unit : mm)

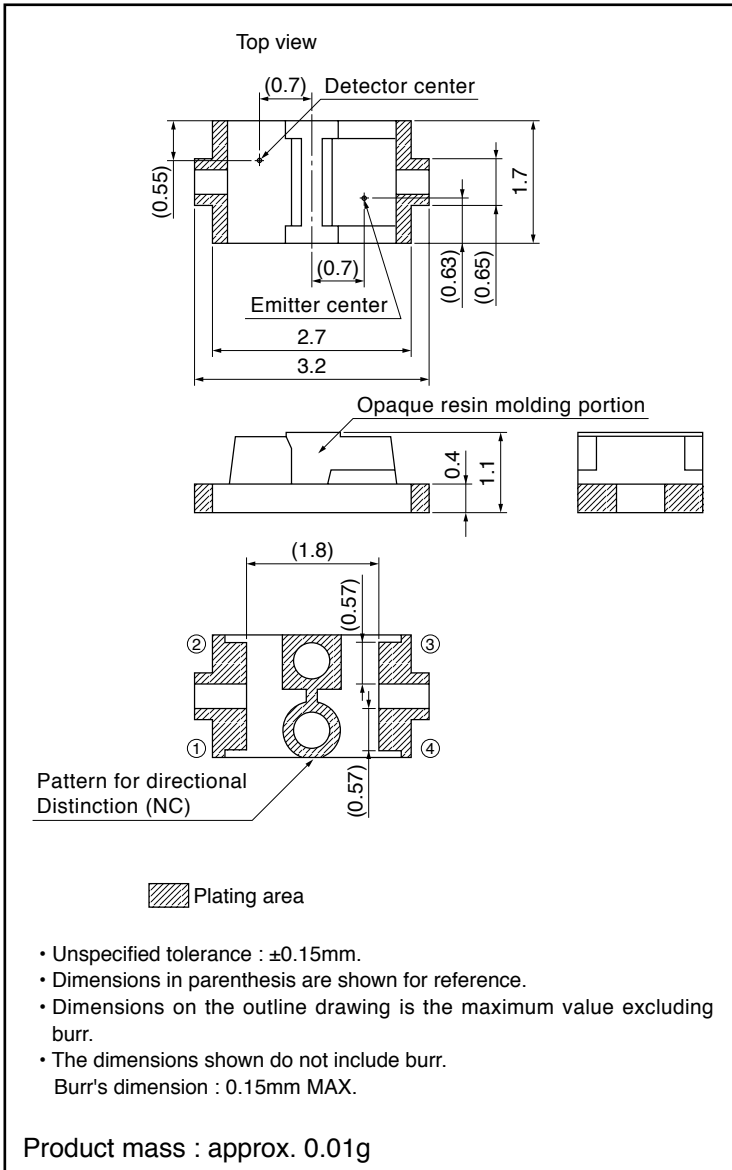

Plating material : Au

Country of origin
Japan

■ Absolute Maximum Ratings (T_a=25°C)

Parameter		Symbol	Rating	Unit
Input	Forward current	I _F	50	mA
	Reverse voltage	V _R	6	V
	Power dissipation	P _D	75	mW
Output	Collector-emitter voltage	V _{CEO}	35	V
	Emitter-collector voltage	V _{ECO}	6	V
	Collector current	I _C	20	mA
	Collector power dissipation	P _C	75	mW
Total power dissipation		P _{tot}	100	mW
Operating temperature		T _{opr}	-25 to +85	°C
Storage temperature		T _{stg}	-40 to +100	°C
*1 Soldering temperature		T _{sol}	260	°C

*1 For 5s or less

■ Electro-optical Characteristics (T_a=25°C)

Parameter		Symbol	Condition	MIN.	TYP.	MAX.	Unit
Input	Forward voltage	V _F	I _F =20mA	-	1.2	1.4	V
	Reverse current	I _R	V _R =6V	-	-	10	μA
Output	Collector dark current	I _{CEO}	V _{CE} =20V	-	1	100	nA
Transfer characteristics	*2 Collector Current	I _C	I _F =4mA, V _{CE} =2V	40	85	130	μA
	*3 Leak current	I _{LEAK}	I _F =4mA, V _{CE} =2V	-	-	500	nA
	Response time	Rise time	t _r	V _{CE} =2V, I _C =100μA, R _L =1kΩ, d=1mm	-	20	100
Fall time		t _f	-		20	100	

*2 The condition and arrangement of the reflective object are shown below.
The rank splitting of collector current (I_C) shall be executed according to the table below.

Rank	Collector current, I _C [μA] (I _F =4mA, V _{CE} =2V)
A	40 to 80
B	65 to 130

*3 Without reflective object.

● Test Condition and Arrangement for Collector Current

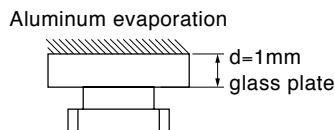

■ Model Line-up

Model No.	Rank	I _c (μ A)	Conditions
GP2S60	A or B	40 to 130	I _F =4mA V _{CE} =2V T _a =25°C
GP2S60A	A	40 to 80	
GP2S60B	B	65 to 130	

Please contact a local SHARP sales representative to see the actual status of the production.

Fig.1 Forward Current vs. Ambient Temperature

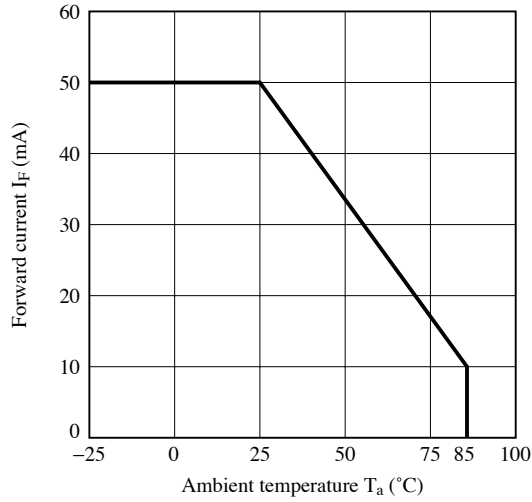

Fig.2 Collector Power Dissipation vs. Ambient Temperature

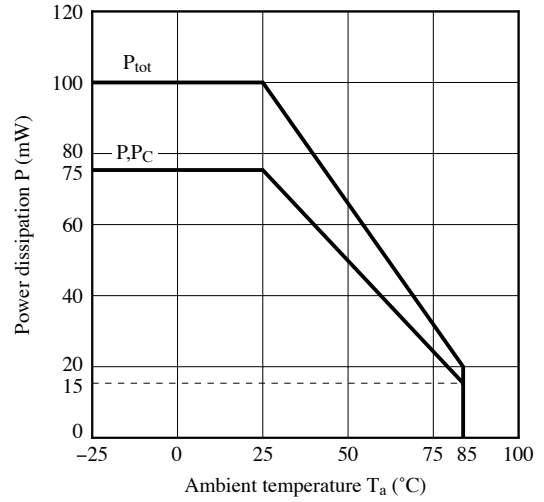

Fig.3 Forward Current vs. Forward Voltage

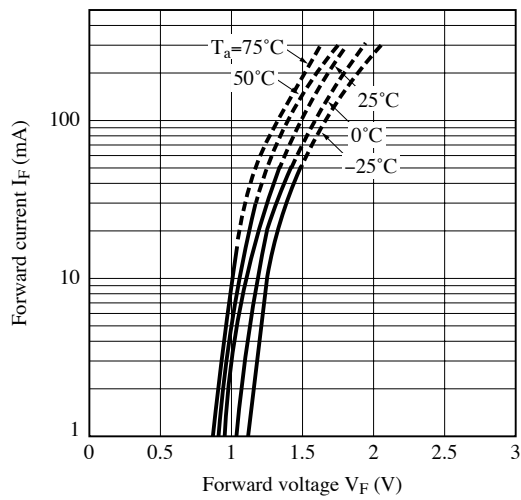

Fig.4 Collector Current vs. Forward Current

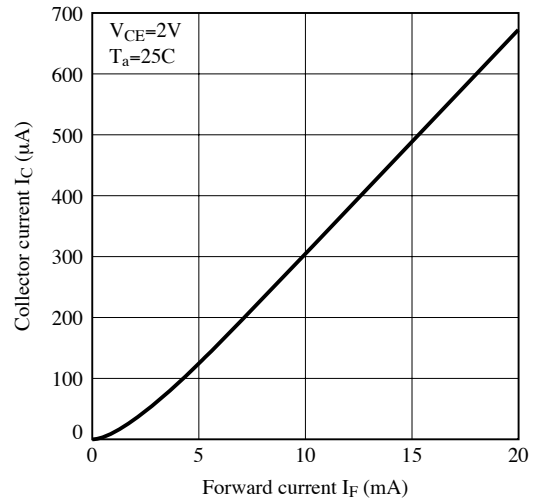

Fig.5 Collector Current vs. Collector-Emitter Voltage

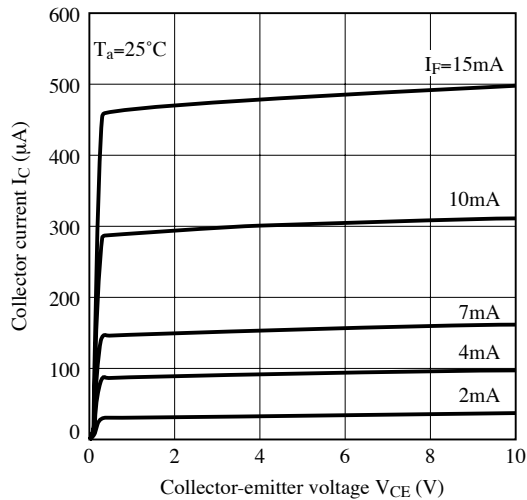

Fig.6 Relative Collector Current vs. Ambient Temperature

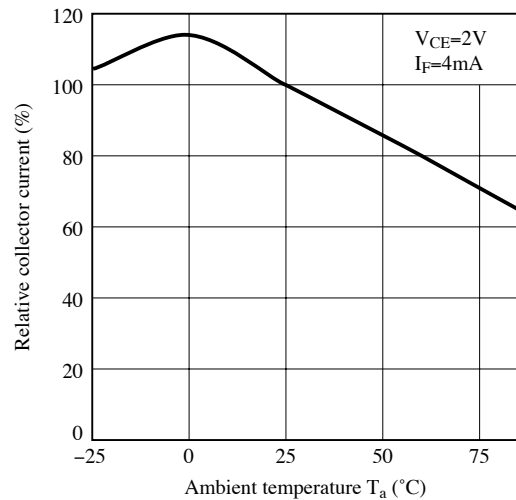

Fig.7 Collector Dark Current vs. Ambient Temperature

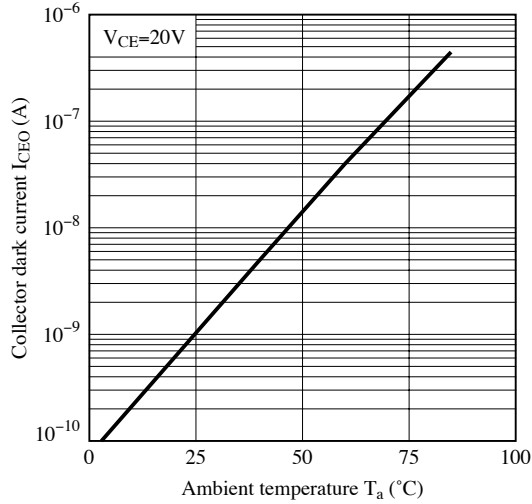

Fig.8 Response Time vs. Load Resistance

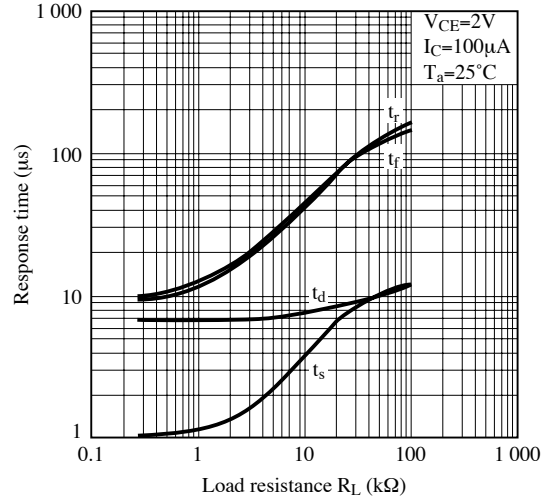

Fig.9 Test Circuit for Response Time

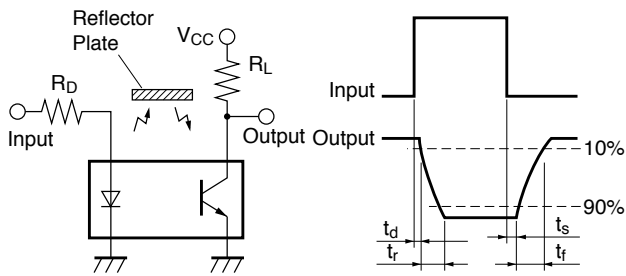

Fig.10 Relative Collector Current vs. Distance

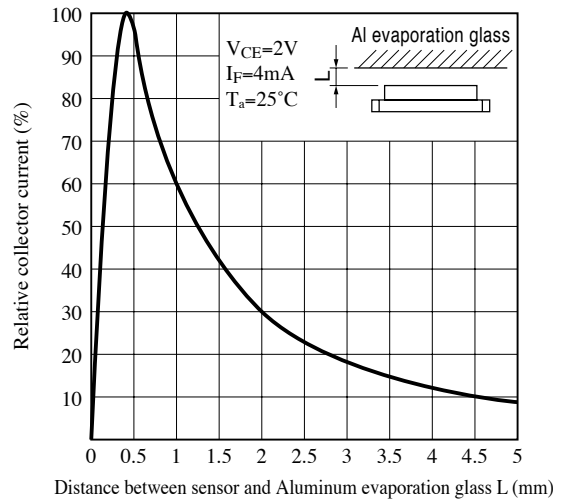

Fig.11 Spectral Sensitivity

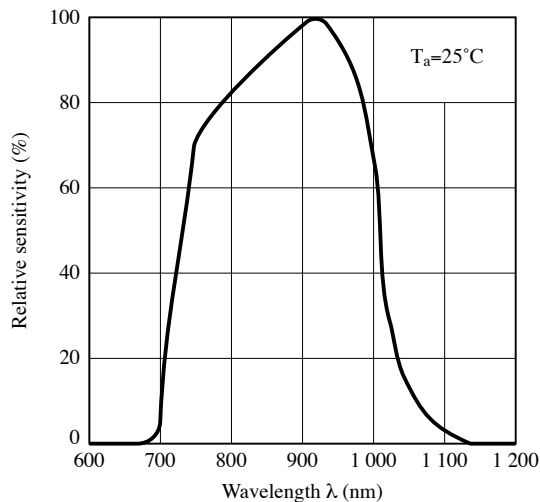

Fig.12 Detecting Position Characteristics (1)

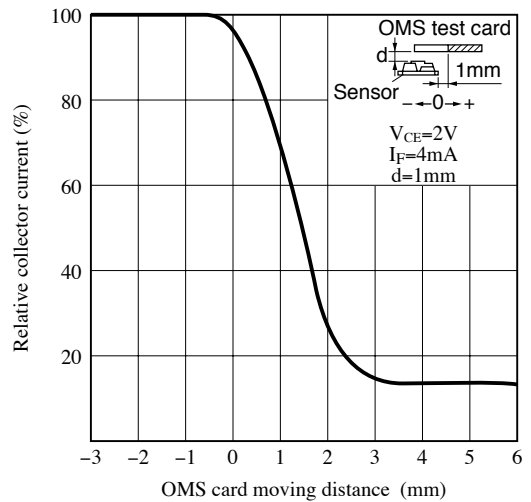
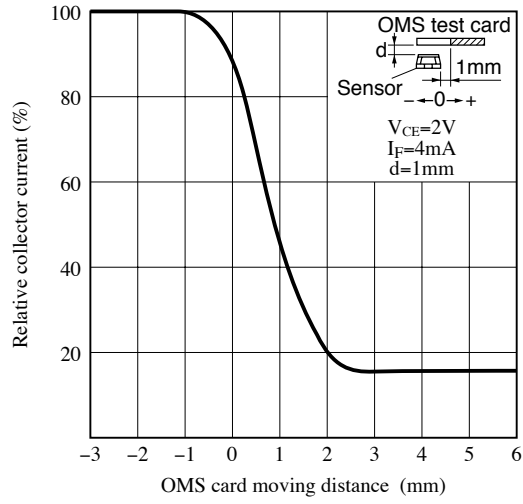

Fig.13 Detecting Position Characteristics (2)



Remarks : Please be aware that all data in the graph are just for reference and not for guarantee.

■ **Design Considerations**

● **Design guide**

- 1) Regarding to prevention of malfunction
To prevent photointerrupter from faulty operation caused by external light, do not set the detecting face to the external light.
- 2) Distance characteristic
The distance between the photointerrupter and the object to be detected shall be determined the distance by referencing Fig.10 "Relative collector current vs. distance".
- 3) For wiring on a mounting PCB
To avoid possibility for short, please do not apply pattern wiring on the back side of the device.
- 4) Regarding to mounting this product
There is a possibility that the opaque molded resin portion may have a crack by force at mounting etc.
Please use this product after well confirmation of conditions in your production line.

This product is not designed against irradiation and incorporates non-coherent IRED.

● **Degradation**

In the case of long term operation, please take the general IRED degradation (50% degradation over 5 years) into the design consideration.

● **Parts**

This product is assembled using the below parts.

• **Light detector (qty. : 1)**

Category	Material	Maximum Sensitivity wavelength (nm)	Sensitivity wavelength (nm)	Response time (μs)
Phototransister	Silicon (Si)	930	700 to 1 200	20

• **Light emitter (qty. : 1)**

Category	Material	Maximum light emitting wavelength (nm)	I/O Frequency (MHz)
Infrared emitting diode (non-coherent)	Gallium arsenide (GaAs)	950	0.3

• **Material**

Case	PCB	Lead frame plating
Epoxy resin Black polyphenylene sulfide	Glass epoxy resin	Au plating

● Recommended pattern

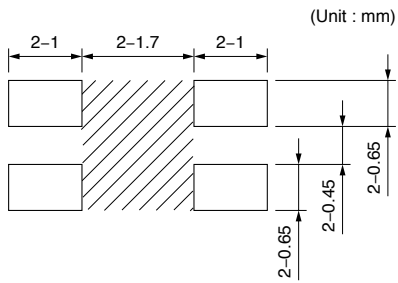

 area : Please do not apply the pattern wiring to avoid the possibility of short circuit.

Regarding amount of solder, if there is solder leakage in terminal wiring pattern between PCB and housing main body, the reliability will be deteriorated.

Please check the proper amount of solder in advance not to have solder leakage into terminal wiring pattern between PCB and housing main body.

■ Manufacturing Guidelines**● Storage and management after open****Storage condition**

Storage temp.: 5 to 30°C, Storage humidity : 70%RH or less at regular packaging.

Treatment after opening the moisture-proof package

After opening, you should mount the products while keeping them on the condition of 5 to 25°C and 70%RH or less in humidity within 4 days.

After opening the bag once even if the prolonged storage is necessary, you should mount the products within two weeks.

And when you store the rest of products you should put into a DRY BOX. Otherwise after the rest of products and silicagel are sealed up again, you should keep them under the condition of 5 to 30°C and 70%RH or less in humidity.

Baking before mounting

When the above-mentioned storage method could not be executed, please process the baking treatment before mounting the products.

However the baking treatment is permitted within one time.

Recommended condition : 125°C, 16 to 24 hours

*Do not process the baking treatment with the product wrapped. When the baking treatment processing, you should move the products to a metallic tray or fix temporarily the products to substrate.

● **Soldering Method**

Reflow Soldering:

Reflow soldering should follow the temperature profile shown below.
 Soldering should not exceed the curve of temperature profile and time.
 Please solder within one time.

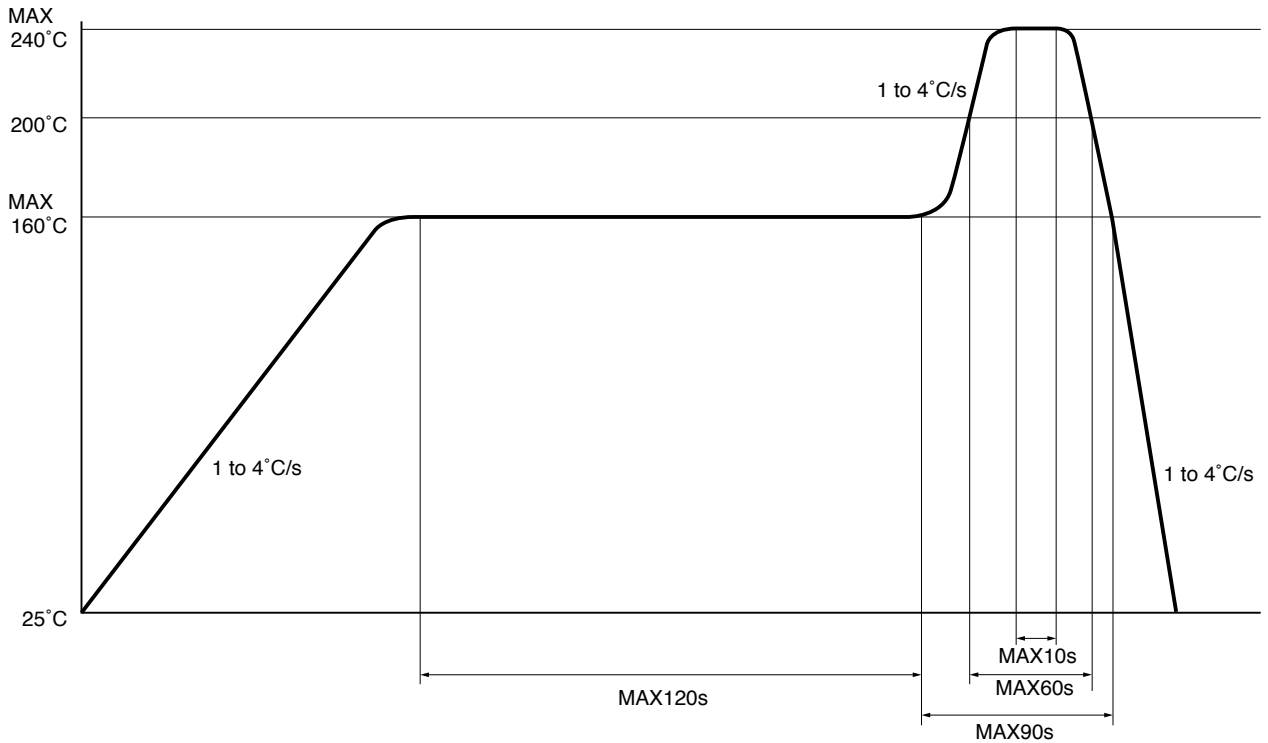

Other notice

Please take care not to let any external force exert on lead pins.
 Please test the soldering method in actual condition and make sure the soldering works fine, since the impact on the junction between the device and PCB varies depending on the cooling and soldering conditions.

● **Cleaning instructions**

Solvent cleaning :

Solvent temperature should be 45°C or below. Immersion time should be 3 minutes or less.

Ultrasonic cleaning :

Do not execute ultrasonic cleaning.

Recommended solvent materials :

Ethyl alcohol, Methyl alcohol and Isopropyl alcohol.

● Presence of ODC

This product shall not contain the following materials.

And they are not used in the production process for this product.

Regulation substances : CFCs, Halon, Carbon tetrachloride, 1.1.1-Trichloroethane (Methylchloroform)

Specific brominated flame retardants such as the PBBOs and PBBs are not used in this product at all.

This product shall not contain the following materials banned in the RoHS Directive (2002/95/EC).

- Lead, Mercury, Cadmium, Hexavalent chromium, Polybrominated biphenyls (PBB), Polybrominated diphenyl ethers (PBDE).

■ Package specification

● Tape and Reel package

Package materials

- Carrier tape : PS (with anti-static material)
- Cover tape : PET (three layer system)
- Reel : PS

Package method

2 000 pcs of products shall be packaged in a reel. One reel with silicagel is enclosed in aluminum laminated bag. After sealing up the bag, it enclosed in one case (5 bags/case).

Carrier tape structure and Dimensions

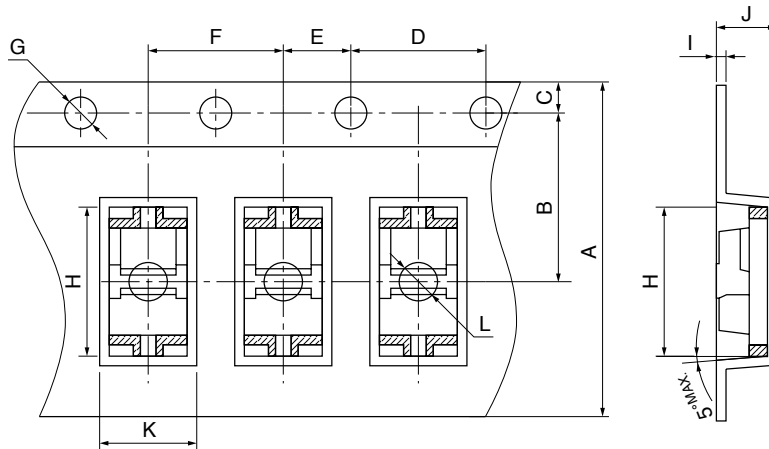

Dimensions List (Unit : mm)

A	B	C	D	E	F
8 ^{±0.3}	3.5 ^{±0.05}	1.75 ^{±0.1}	4 ^{±0.1}	2 ^{±0.1}	4 ^{±0.1}
G	H	I	J	K	L
φ1.55 ^{±0.05}	3.6 ^{±0.1}	0.3 ^{±0.05}	1.25 ^{±0.1}	2.2 ^{±0.1}	φ1.1 ^{±0.1}

Reel structure and Dimensions

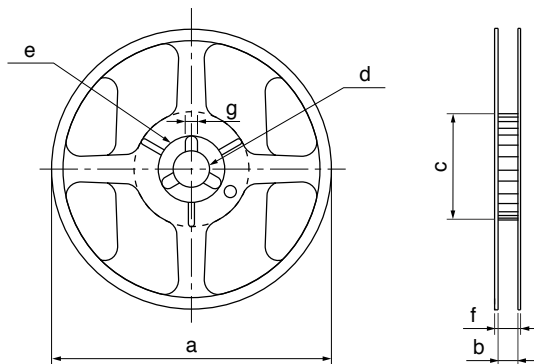

Dimensions List (Unit : mm)

a	b	c	d
180	9 ^{±1}	60 ^{+0.5} ₋₀	φ13 ^{±0.2}
e	f	g	
φ21 ^{±0.8}	11.4 ^{±1}	2 ^{+0.3} ₋₀	

Direction of product insertion

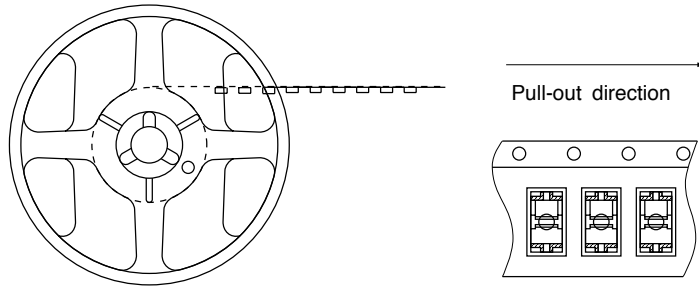

[Packing : 2 000pcs/reel]

Storage method

Storage conditions should follow the condition shown below.

Storage temperature : 5 to 30°C

Storage humidity : 70%RH or less

■ Important Notices

· The circuit application examples in this publication are provided to explain representative applications of SHARP devices and are not intended to guarantee any circuit design or license any intellectual property rights. SHARP takes no responsibility for any problems related to any intellectual property right of a third party resulting from the use of SHARP's devices.

· Contact SHARP in order to obtain the latest device specification sheets before using any SHARP device. SHARP reserves the right to make changes in the specifications, characteristics, data, materials, structure, and other contents described herein at any time without notice in order to improve design or reliability. Manufacturing locations are also subject to change without notice.

· Observe the following points when using any devices in this publication. SHARP takes no responsibility for damage caused by improper use of the devices which does not meet the conditions and absolute maximum ratings to be used specified in the relevant specification sheet nor meet the following conditions:

(i) The devices in this publication are designed for use in general electronic equipment designs such as:

- Personal computers
- Office automation equipment
- Telecommunication equipment [terminal]
- Test and measurement equipment
- Industrial control
- Audio visual equipment
- Consumer electronics

(ii) Measures such as fail-safe function and redundant design should be taken to ensure reliability and safety when SHARP devices are used for or in connection

with equipment that requires higher reliability such as:

- Transportation control and safety equipment (i.e., aircraft, trains, automobiles, etc.)
- Traffic signals
- Gas leakage sensor breakers
- Alarm equipment
- Various safety devices, etc.

(iii) SHARP devices shall not be used for or in connection with equipment that requires an extremely high level of reliability and safety such as:

- Space applications
- Telecommunication equipment [trunk lines]
- Nuclear power control equipment
- Medical and other life support equipment (e.g., scuba).

· If the SHARP devices listed in this publication fall within the scope of strategic products described in the Foreign Exchange and Foreign Trade Law of Japan, it is necessary to obtain approval to export such SHARP devices.

· This publication is the proprietary product of SHARP and is copyrighted, with all rights reserved. Under the copyright laws, no part of this publication may be reproduced or transmitted in any form or by any means, electronic or mechanical, for any purpose, in whole or in part, without the express written permission of SHARP. Express written permission is also required before any use of this publication may be made by a third party.

· Contact and consult with a SHARP representative if there are any questions about the contents of this publication.

Компания «Океан Электроники» предлагает заключение долгосрочных отношений при поставках импортных электронных компонентов на взаимовыгодных условиях!

Наши преимущества:

- Поставка оригинальных импортных электронных компонентов напрямую с производств Америки, Европы и Азии, а так же с крупнейших складов мира;
- Широкая линейка поставок активных и пассивных импортных электронных компонентов (более 30 млн. наименований);
- Поставка сложных, дефицитных, либо снятых с производства позиций;
- Оперативные сроки поставки под заказ (от 5 рабочих дней);
- Экспресс доставка в любую точку России;
- Помощь Конструкторского Отдела и консультации квалифицированных инженеров;
- Техническая поддержка проекта, помощь в подборе аналогов, поставка прототипов;
- Поставка электронных компонентов под контролем ВП;
- Система менеджмента качества сертифицирована по Международному стандарту ISO 9001;
- При необходимости вся продукция военного и аэрокосмического назначения проходит испытания и сертификацию в лаборатории (по согласованию с заказчиком);
- Поставка специализированных компонентов военного и аэрокосмического уровня качества (Xilinx, Altera, Analog Devices, Intersil, Interpoint, Microsemi, Actel, Aeroflex, Peregrine, VPT, Syfer, Eurofarad, Texas Instruments, MS Kennedy, Miteq, Cobham, E2V, MA-COM, Hittite, Mini-Circuits, General Dynamics и др.);

Компания «Океан Электроники» является официальным дистрибьютором и эксклюзивным представителем в России одного из крупнейших производителей разъемов военного и аэрокосмического назначения «**JONHON**», а так же официальным дистрибьютором и эксклюзивным представителем в России производителя высокотехнологичных и надежных решений для передачи СВЧ сигналов «**FORSTAR**».



JONHON

«**JONHON**» (основан в 1970 г.)

Разъемы специального, военного и аэрокосмического назначения:

(Применяются в военной, авиационной, аэрокосмической, морской, железнодорожной, горно- и нефтедобывающей отраслях промышленности)

«**FORSTAR**» (основан в 1998 г.)

ВЧ соединители, коаксиальные кабели,
кабельные сборки и микроволновые компоненты:

(Применяются в телекоммуникациях гражданского и специального назначения, в средствах связи, РЛС, а так же военной, авиационной и аэрокосмической отраслях промышленности).



Телефон: 8 (812) 309-75-97 (многоканальный)

Факс: 8 (812) 320-03-32

Электронная почта: ocean@oceanchips.ru

Web: <http://oceanchips.ru/>

Адрес: 198099, г. Санкт-Петербург, ул. Калинина, д. 2, корп. 4, лит. А