

265 V PTC Thermistors For Overload Protection



FEATURES

- Wide range of trip and non-trip currents:
From 11 mA up to 800 mA
- Small ratio between trip and non-trip currents
($I_t/I_{nt} = 1.5$ at 25 °C)
- High maximum inrush current (up to 5.5 A)
- Leaded parts withstand mechanical stresses and vibration
- UL file E148885 according to XGPU standard UL1434
- UL approved PTCs are guaranteed to withstand severe test programs
 - Long-life cycle tests (over 5000 trip cycles)
 - Long-life storage tests (3000 h at 250 °C)
 - Electrical cycle tests at low ambient temperatures (- 40 °C or 0 °C)
 - Damp-heat and water immersion tests
 - Overvoltage tests at up to 200 % of rated voltage
- Compliant to RoHS directive 2002/95/EC and in accordance to WEEE 2002/96/EC

RoHS
COMPLIANT

APPLICATIONS

Over-temperature/over-load protection:

- Telecommunications
- Automotive systems
- Industrial electronics
- Consumer electronics
- Electronic data processing

DESCRIPTION

These directly heated thermistors have a positive temperature coefficient and are primarily intended for overload protection. They consist of a metallized ceramic disk with two tinned brass or copper clad steel leads reflow soldered to it and coated with a high temperature silicone lacquer. Leadless disks and leaded disks without coating are available on request.

MOUNTING

The PTC Thermistors are suitable for processing on automatic insertion equipment.

Typical soldering

235 °C; duration: 5 s (Pb-bearing)
245 °C; duration: 5 s (Lead (Pb)-free)

Resistance to soldering heat

260 °C; duration: 10 s max.

MARKING

Only the grey lacquered thermistors with a diameter of 8.5 mm to 20.5 mm are marked with BC, R_{25} value (example 1R9) on one side and I_{nt} , V_{max} on the other side.

QUICK REFERENCE DATA		
PARAMETER	VALUE	UNIT
Holding current	0.011 to 0.8	A
Resistance at 25 °C (R_{25})	2.1 to 3000	Ω
I_{max}	0.8 to 5.5	A
Switch temperature	140	°C
Maximum voltage (RMS or DC)	265	V
Operating temperature range at max. voltage	0 to 70	°C
Climatic category	25/125/56	

ELECTRICAL DATA AND ORDERING INFORMATION for 2381 66. 5...3; max. voltage = 265 V (AC or DC) ⁽¹⁾								
I _{nt} MAX. at 25 °C (mA)	I _t MIN. at 25 °C (mA)	R ₂₅ ± 20 % (Ω)	I ⁽²⁾ MAX. at 25 °C (mA)	I _{res} MAX. at V _{max.} and 25 °C (mA)	DISSIP. FACTOR (mW/K)	Ø D MAX. (mm)	CATALOG NUMBERS	
							BULK	TAPE ON REEL
11	17	3000	80	6.5	7.3	5	2381 660 51193	2381 660 61193
15	23	1900	110	6.5	7.3	5	2381 660 51593	2381 660 61593
19	29	1200	140	6.5	7.3	5	2381 660 51993	2381 660 61993
28	42	500	200	6.8	7.3	5	2381 660 52893	2381 660 62893
39	59	260	300	6.8	7.3	5	2381 660 53993	2381 660 63993
63	95	120	450	7	7.3	5	2381 660 56393	2381 660 66393
76	115	85	550	7	7.3	5	2381 660 57693	2381 660 67693
95	143	56	600	7	7.3	5	2381 660 59593	2381 660 69593
110	165	48	650	7.5	8.3	7	2381 661 51113	2381 661 61113
140	210	29	800	8	8.3	7	2381 661 51413	2381 661 61413
170	255	22	900	9	9	8.5	2381 661 51713	2381 661 61713
190	285	18	1000	9.5	9	8.5	2381 661 51913	2381 661 61913
210	315	17	1300	10	10.5	10.5	2381 662 52113	2381 662 62113
250	375	12	1500	11	10.5	10.5	2381 662 52513	2381 662 62513
280	420	11	1800	12	11.7	12.5	2381 662 52813	2381 662 62813
320	480	8.4	2200	13	11.7	12.5	2381 662 53213	2381 662 63213
400	600	6.6	3000	15	15.5	16.5	2381 663 54013	-
490	735	4.4	3500	16	15.5	16.5	2381 663 54913	-
590	855	4	4500	19.5	19.8	20.5	2381 664 55913	-
700	1050	2.8	5500	21	19.8	20.5	2381 664 57013	-
800	1200	2.1	5500	22.5	19.8	20.5	2381 664 58013 ⁽³⁾	-

Notes

- ⁽¹⁾ The thermistors are clamped at the seating plane
- ⁽²⁾ I_{max.} is the maximum overload current that may flow through the PTC when it passes from the low ohmic to the high ohmic state.
UL approval: I_{max.} x 0.75
- ⁽³⁾ Not UL approved

SAP AND 12NC PART NUMBERS			
12NC	SAP CODING	12NC	SAP CODING
2381 660 x1193	PTCCL05H110HyE	2381 661 x1913	PTCCL09H191HyE
2381 660 x1593	PTCCL05H150HyE	2381 662 x2113	PTCCL11H211HyE
2381 660 x1993	PTCCL05H190HyE	2381 662 x2513	PTCCL11H251HyE
2381 660 x2893	PTCCL05H280HyE	2381 662 x2813	PTCCL13H281HyE
2381 660 x3993	PTCCL05H390HyE	2381 662 x3213	PTCCL13H321HyE
2381 660 x6393	PTCCL05H630HyE	2381 663 54013	PTCCL17H401HBE
2381 660 x7693	PTCCL05H760HyE	2381 663 54913	PTCCL17H491HBE
2381 660 x9593	PTCCL05H950HyE	2381 664 55913	PTCCL21H591HBE
2381 661 x1113	PTCCL07H111HyE	2381 664 57013	PTCCL21H701HBE
2381 661 x1413	PTCCL07H141HyE	2381 664 58013	PTCCL21H801HBE
2381 661 x1713	PTCCL09H171HyE		

Notes

- For bulk parts replace x by "5" and y by "B"
- For taped on reel parts replace x by "6" and y by "T"

CURRENT DEVIATION AS A FUNCTION OF THE AMBIENT TEMPERATURE

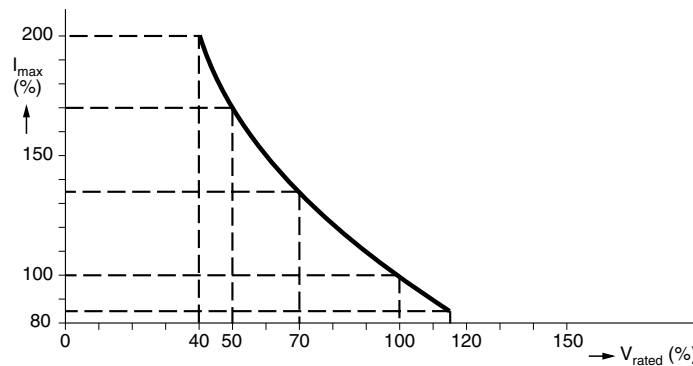

VOLTAGE DERATING AS A FUNCTION OF AMBIENT TEMPERATURE

ELECTRICAL CHARACTERISTICS I_{max}. AS A FUNCTION OF VOLTAGE

I_{max} . as stated in the electrical data and ordering information tables, is the maximum overload current that may flow through the PTC when passing from the low ohmic to high ohmic state at rated voltage.

When other voltages are present after tripping, the I_{max} . value can be derived from the above I_{max} . as a function of voltage graph. Voltages below V_{rated} will allow higher overload currents to pass the PTC.

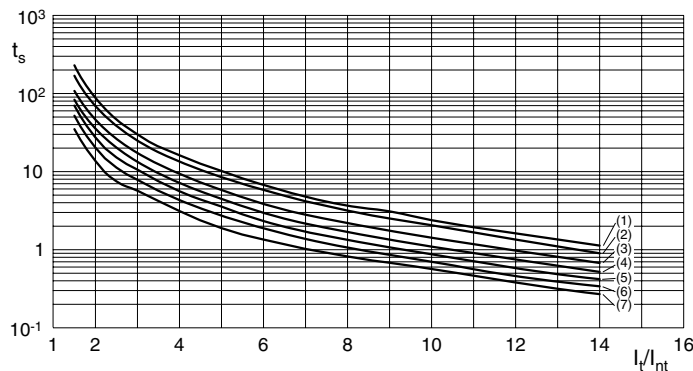
TYPICAL TRIP-TIME AS A FUNCTION OF TRIP CURRENT RATIO

Curve 1: Ø D_{max}. = 20.5 mm
 Curve 2: Ø D_{max}. = 16.5 mm
 Curve 3: Ø D_{max}. = 12.5 mm
 Curve 4: Ø D_{max}. = 10.5 mm
 Curve 5: Ø D_{max}. = 8.5 mm
 Curve 6: Ø D_{max}. = 7.0 mm
 Curve 7: Ø D_{max}. = 5.0 mm
 Measured in accordance with "IEC 60738".

Trip-time or switching time (t_s)

To check the trip-time for a specific PTC, refer to the Electrical Data and Ordering Information tables for the value I_{nt} . Divide the overload or trip current by this I_{nt} and you realize the factor I_t/I_{nt} . This rule is valid for any ambient temperature between 0 °C and 70 °C. Adapt the correct non-trip current with the appropriate curve in the Current Deviation as a Function of the Ambient Temperature graph. The relationship between the I_t/I_{nt} factor and the switching time is a function of the PTC diameter; see the above graphs.

Example

What will be the trip-time at $I_{ol} = 0.8$ A and $T_{amb} = 50$ °C of a thermistor type 2381 661 51713; 22 Ω; Ø D_{max}. = 8.5 mm:

I_{nt} from the table: 170 mA at 25 °C

I_{nt} : 170 x 0.87 = 148 mA (at 50 °C).

Overload current = 0.8 A; factor I_t/I_{nt} : $0.8/0.148 = 5.40$. In the typical trip-time as a function of trip current ratio graph, at the 8.5 mm line and $I_t/I_{nt} = 5.40$, the typical trip-time is 3.0 s.

COMPONENTS OUTLINE			
CODE NUMBER 2381		SPQ	OUTLINE
660	5...3	500	Fig. 1a
	6...3	1500	Fig. 1b
661	5...3	250	Fig. 1a
	6...3	1500	Fig. 1b
662	5...3	200	Fig. 1a
	62113 - 62513	1500	Fig. 1b
	62813 - 63213	750	Fig. 1c
663	5...3	100	Fig. 1a
664	5...3	50	Fig. 1a

PTC THERMISTORS IN BULK



Fig. 1a

DIMENSIONS OF BULK TYPE PTC'S (in mm)	
D	See table
d	0.6 ± 10 %
T	5.5 max.
H2	4.0 ± 1.0
H3	D + 5 max.
L1	20 min.
F	5.0

PTC THERMISTORS ON TAPE ON REEL

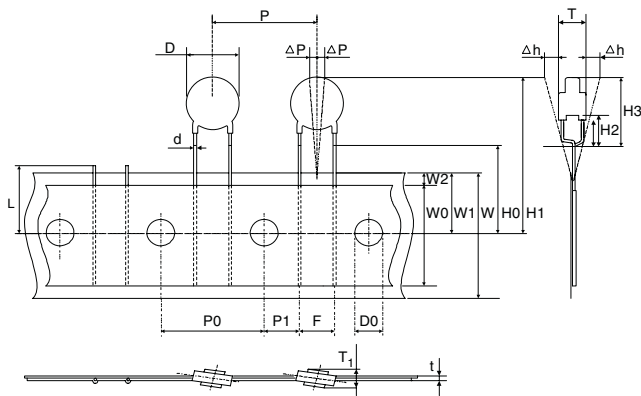

Fig. 1b

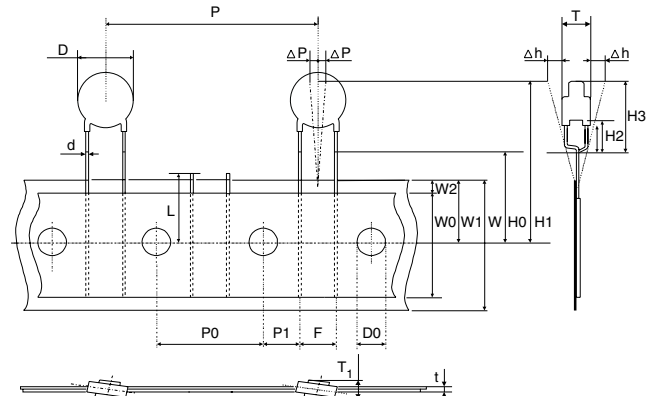

Fig. 1c

TAPE AND REEL ACCORDING TO IEC 60286-2 dimensions in millimeters			
SYMBOL	PARAMETER	DIMENSIONS	TOLERANCE
D	Body diameter	See table	max.
d	Lead diameter	0.6	± 10 %
P	Pitch of components Diameter < 12 mm Diameter ≥ 12 mm	12.7	± 1.0
		25.4	± 2.0
F	Leadcenter to leadcenter distance (between component and tape)	5.0	+ 0.6 - 0.1
H0	Lead wire clinch height	16.0	± 0.5
H2	Component bottom to seating plane	4.0	± 1.0
H3	Component top to seating plane	D + 5	max.
H4	Seating plane difference (left-right lead)	0	± 0.2
T	Total thickness	5.5	max.



TYPICAL RESISTANCE/TEMPERATURE CHARACTERISTIC



TYPICAL RESISTANCE/TEMPERATURE CHARACTERISTIC



TYPICAL RESISTANCE/TEMPERATURE CHARACTERISTIC

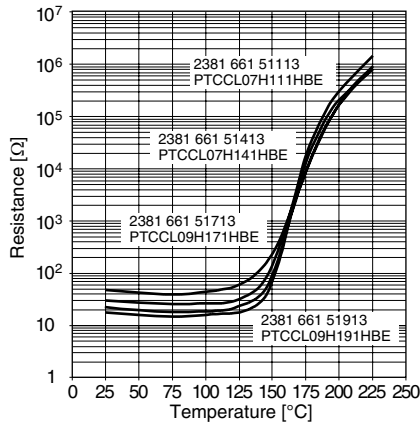

TYPICAL RESISTANCE/TEMPERATURE CHARACTERISTIC

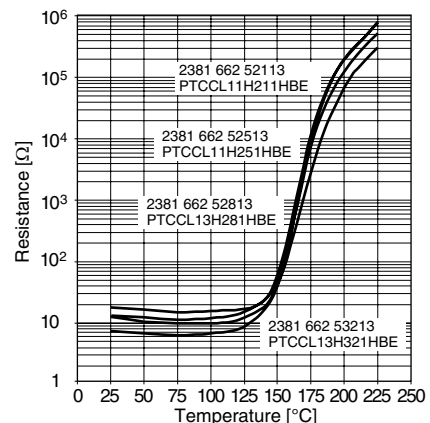

TYPICAL RESISTANCE/TEMPERATURE CHARACTERISTIC

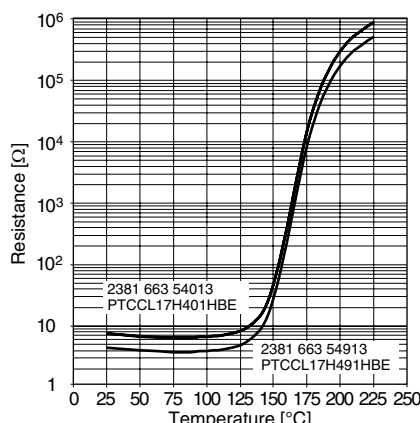

TYPICAL RESISTANCE/TEMPERATURE CHARACTERISTIC

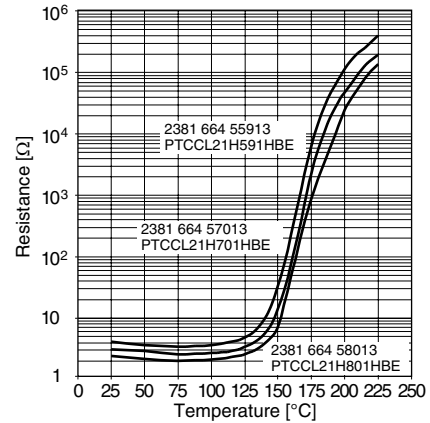



Disclaimer

ALL PRODUCT, PRODUCT SPECIFICATIONS AND DATA ARE SUBJECT TO CHANGE WITHOUT NOTICE TO IMPROVE RELIABILITY, FUNCTION OR DESIGN OR OTHERWISE.

Vishay Intertechnology, Inc., its affiliates, agents, and employees, and all persons acting on its or their behalf (collectively, "Vishay"), disclaim any and all liability for any errors, inaccuracies or incompleteness contained in any datasheet or in any other disclosure relating to any product.

Vishay makes no warranty, representation or guarantee regarding the suitability of the products for any particular purpose or the continuing production of any product. To the maximum extent permitted by applicable law, Vishay disclaims (i) any and all liability arising out of the application or use of any product, (ii) any and all liability, including without limitation special, consequential or incidental damages, and (iii) any and all implied warranties, including warranties of fitness for particular purpose, non-infringement and merchantability.

Statements regarding the suitability of products for certain types of applications are based on Vishay's knowledge of typical requirements that are often placed on Vishay products in generic applications. Such statements are not binding statements about the suitability of products for a particular application. It is the customer's responsibility to validate that a particular product with the properties described in the product specification is suitable for use in a particular application. Parameters provided in datasheets and/or specifications may vary in different applications and performance may vary over time. All operating parameters, including typical parameters, must be validated for each customer application by the customer's technical experts. Product specifications do not expand or otherwise modify Vishay's terms and conditions of purchase, including but not limited to the warranty expressed therein.

Except as expressly indicated in writing, Vishay products are not designed for use in medical, life-saving, or life-sustaining applications or for any other application in which the failure of the Vishay product could result in personal injury or death. Customers using or selling Vishay products not expressly indicated for use in such applications do so at their own risk. Please contact authorized Vishay personnel to obtain written terms and conditions regarding products designed for such applications.

No license, express or implied, by estoppel or otherwise, to any intellectual property rights is granted by this document or by any conduct of Vishay. Product names and markings noted herein may be trademarks of their respective owners.

Material Category Policy

Vishay Intertechnology, Inc. hereby certifies that all its products that are identified as RoHS-Compliant fulfill the definitions and restrictions defined under Directive 2011/65/EU of The European Parliament and of the Council of June 8, 2011 on the restriction of the use of certain hazardous substances in electrical and electronic equipment (EEE) - recast, unless otherwise specified as non-compliant.

Please note that some Vishay documentation may still make reference to RoHS Directive 2002/95/EC. We confirm that all the products identified as being compliant to Directive 2002/95/EC conform to Directive 2011/65/EU.

Vishay Intertechnology, Inc. hereby certifies that all its products that are identified as Halogen-Free follow Halogen-Free requirements as per JEDEC JS709A standards. Please note that some Vishay documentation may still make reference to the IEC 61249-2-21 definition. We confirm that all the products identified as being compliant to IEC 61249-2-21 conform to JEDEC JS709A standards.

Компания «Океан Электроники» предлагает заключение долгосрочных отношений при поставках импортных электронных компонентов на взаимовыгодных условиях!

Наши преимущества:

- Поставка оригинальных импортных электронных компонентов напрямую с производств Америки, Европы и Азии, а так же с крупнейших складов мира;
- Широкая линейка поставок активных и пассивных импортных электронных компонентов (более 30 млн. наименований);
- Поставка сложных, дефицитных, либо снятых с производства позиций;
- Оперативные сроки поставки под заказ (от 5 рабочих дней);
- Экспресс доставка в любую точку России;
- Помощь Конструкторского Отдела и консультации квалифицированных инженеров;
- Техническая поддержка проекта, помощь в подборе аналогов, поставка прототипов;
- Поставка электронных компонентов под контролем ВП;
- Система менеджмента качества сертифицирована по Международному стандарту ISO 9001;
- При необходимости вся продукция военного и аэрокосмического назначения проходит испытания и сертификацию в лаборатории (по согласованию с заказчиком);
- Поставка специализированных компонентов военного и аэрокосмического уровня качества (Xilinx, Altera, Analog Devices, Intersil, Interpoint, Microsemi, Actel, Aeroflex, Peregrine, VPT, Syfer, Eurofarad, Texas Instruments, MS Kennedy, Miteq, Cobham, E2V, MA-COM, Hittite, Mini-Circuits, General Dynamics и др.);

Компания «Океан Электроники» является официальным дистрибьютором и эксклюзивным представителем в России одного из крупнейших производителей разъемов военного и аэрокосмического назначения «JONHON», а так же официальным дистрибьютором и эксклюзивным представителем в России производителя высокотехнологичных и надежных решений для передачи СВЧ сигналов «FORSTAR».



JONHON

«JONHON» (основан в 1970 г.)

Разъемы специального, военного и аэрокосмического назначения:

(Применяются в военной, авиационной, аэрокосмической, морской, железнодорожной, горно- и нефтедобывающей отраслях промышленности)

«FORSTAR» (основан в 1998 г.)

ВЧ соединители, коаксиальные кабели,
кабельные сборки и микроволновые компоненты:

(Применяются в телекоммуникациях гражданского и специального назначения, в средствах связи, РЛС, а так же военной, авиационной и аэрокосмической отраслях промышленности).



Телефон: 8 (812) 309-75-97 (многоканальный)

Факс: 8 (812) 320-03-32

Электронная почта: ocean@oceanchips.ru

Web: <http://oceanchips.ru/>

Адрес: 198099, г. Санкт-Петербург, ул. Калинина, д. 2, корп. 4, лит. А