

DC Brushless Fan Motor Drivers

Three-Phase Full-Wave Fan Motor Driver

BD6326NUX

General description

BD6326NUX is a three-phase sensorless fan motor driver used to cool off notebook PCs. It is controlled by a variable speed provided through the PWM input signal. Its feature is sensorless drive which doesn't require a hall device as a location detection sensor and motor downsizing can be achieved by limiting the number of external components as much as possible. Furthermore, introducing a direct PWM soft switched driving mechanism achieves silent operations and low vibrations.

Features

- Speed controllable by PWM input signal
- 180° Sinusoidal drive
- Power save function
- Internal RNF resistance
- Motor rotation direction select function(FR)

Application

- Small fan motor notebook PCs etc.

Absolute maximum ratings

Parameter	Symbol	Limit	Unit
Supply voltage	V_{CC}	7	V
Power dissipation (NOTE 1)	P_d	0.58	W
Operating temperature	T_{opr}	-25 to +95	°C
Storage temperature	T_{stg}	-55 to +150	°C
Output voltage	V_{omax}	7	V
Output current (NOTE 2)	I_{omax}	700	mA
FG signal output voltage	V_{FG}	7	V
FG signal output current	I_{FG}	6	mA
Junction temperature	T_{jmax}	150	°C

(NOTE 1) Reduce by 4.64mW/°C over $T_a=25^{\circ}C$. (On 74.2mm×74.2mm×1.6mm glass epoxy board)

(NOTE 2) This value is not to exceed P_d .

Caution: Operating the IC over the absolute maximum ratings may damage the IC. The damage can either be a short circuit between pins or an open circuit between pins and the internal circuitry. Therefore, it is important to consider circuit protection measures, such as adding a fuse, in case the IC is operated over the absolute maximum ratings.

Recommended operating condition

Parameter	Symbol	Limit	Unit
Operating supply voltage range	V_{CC}	2.2 to 5.5	V
Input voltage range(PWM, FR terminals)	V_{INx}	0 to V_{CC}	V

Package

VSON010X3030

W(Typ) x D(Typ) x H(Max)

3.00mm x 3.00mm x 0.60mm



Pin Configuration

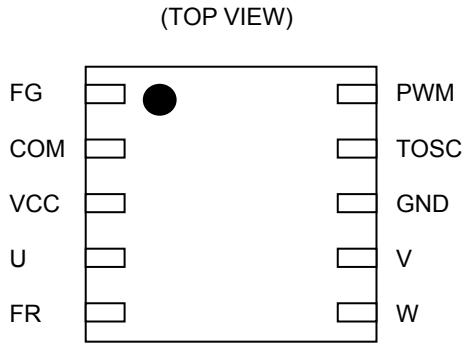

Figure 1. Pin configuration

Pin Description

P/No.	T/name	Function
1	FG	FG output terminal
2	COM	Coil midpoint terminal
3	VCC	Power supply terminal
4	U	U phase output terminal
5	FR	Motor rotation direction select terminal
6	W	W phase output terminal
7	V	V phase output terminal
8	GND	GND terminal
9	TOSC	Start-up oscillation terminal
10	PWM	PWM signal input terminal

Block Diagram

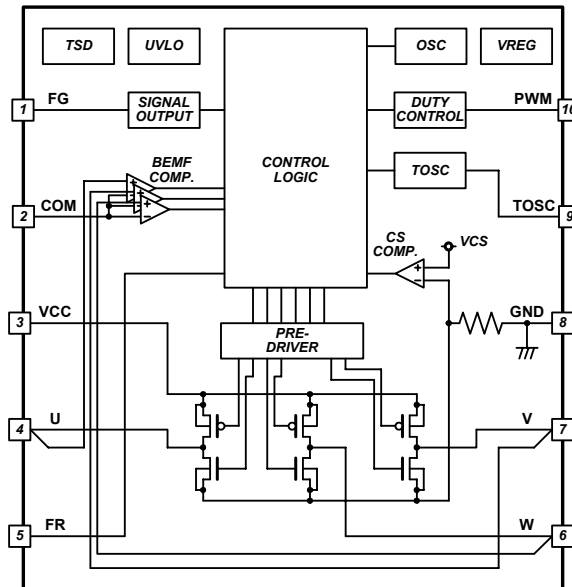

Figure 2. Block diagram

Electrical characteristics (Unless otherwise specified $T_a=25^{\circ}\text{C}$, $V_{CC}=5\text{V}$)

Parameter	Symbol	Limit			Unit	Conditions
		Min	Typ	Max		
<OVERALL>						
Circuit current STB	I_{CST}	-	20	50	μA	
Circuit current	I_{CC}	2.4	5.5	8.6	mA	
<PWM terminal>						
PWM input H level	V_{PH}	2.5	-	V_{CC}	V	
PWM input L level	V_{PL}	0	-	0.7	V	
PWM input current H	I_{PH}	-	0	1	μA	PWM=VCC
PWM input current L	I_{PL}	-50	-20	-	μA	PWM=GND
Input frequency	f_P	20	-	50	kHz	
<FR terminal>						
FR input H level	V_{OH}	2.5	-	V_{CC}	V	FR=H : Normal rotation
FR input L level	V_{OL}	0	-	0.5	V	FR=L; Reverse rotation
<TOSC terminal>						
TOSC frequency	f_{OSF}	28	40	52	kHz	TOSC-GND 2200pF
TOSC charge current	I_{OCC}	-137.5	-110	-82.5	μA	TOSC=0.5V
TOSC discharge current	I_{ODC}	75	100	125	μA	TOSC=1.0V
<FG terminal>						
FG low voltage	V_{FGL}	-	-	0.4	V	IFG=5mA
<Output terminals>						
Output voltage	V_O	-	0.25	0.325	V	$I_o=250\text{mA}$ (H.L. total)
PWM off time	t_{PO}	0.3	1	2	ms	
Lock protection det. time	t_{LDT}	0.6	0.9	1.5	s	
Lock protection rel. time	t_{LRT}	3.3	5.0	8.3	s	

About a current item, define the inflow current to IC as a positive notation, and the outflow current from IC as a negative notation.

Typical Performance Curves 1
(Reference data)

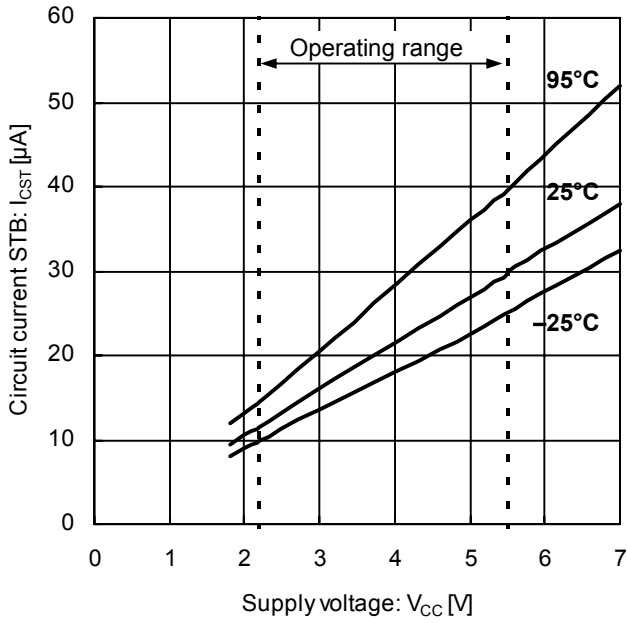

Figure 3. Circuit current STB

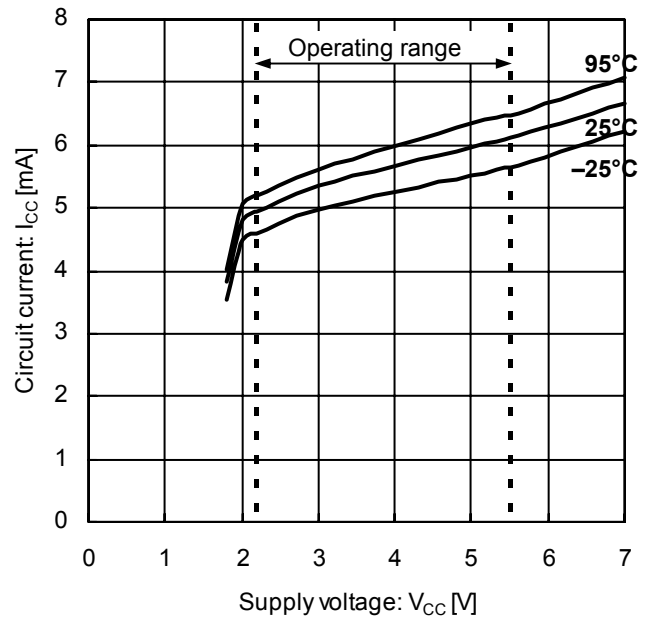

Figure 4. Circuit current

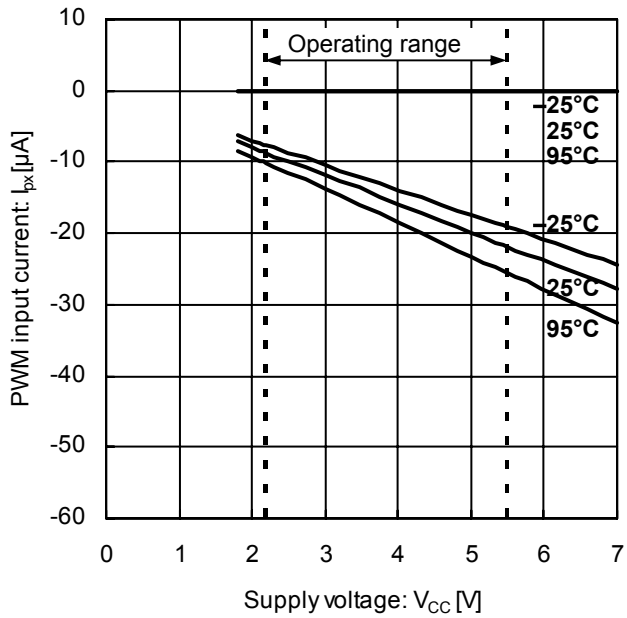

Figure 5. PWM input current

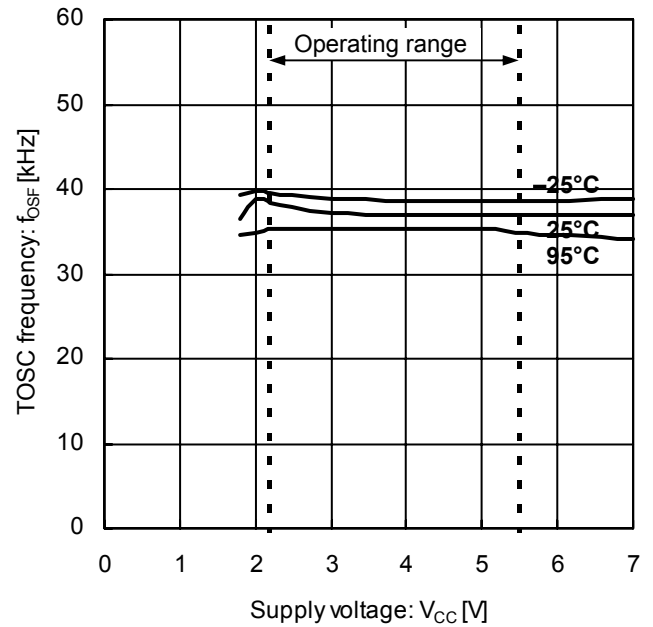

Figure 6. TOSC frequency

Typical Performance Curves 2

(Reference data)

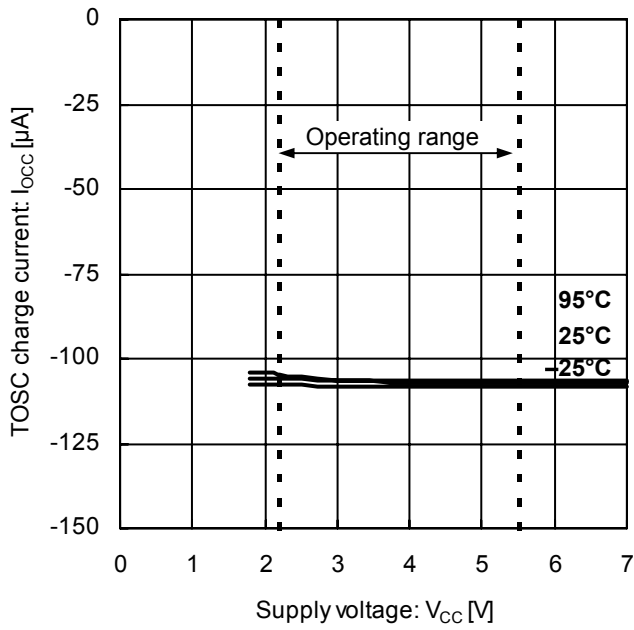

Figure 7. TOSC charge current

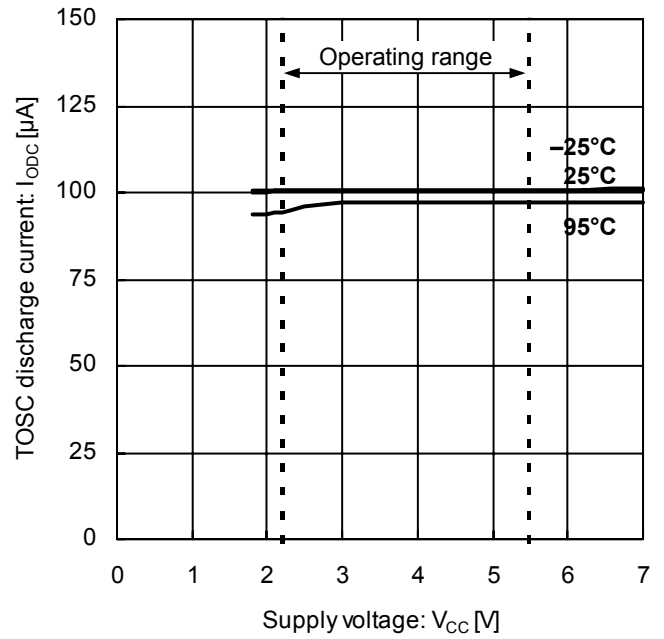

Figure 8. TOSC discharge current

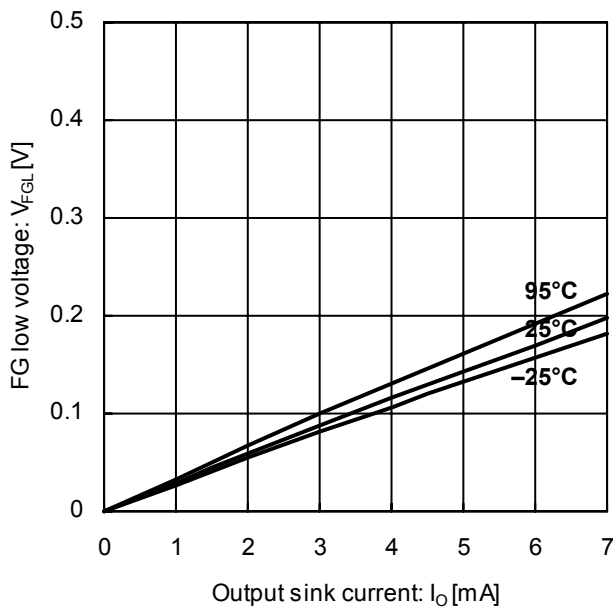

Figure 9. FG low voltage (V_{CC}=5V)

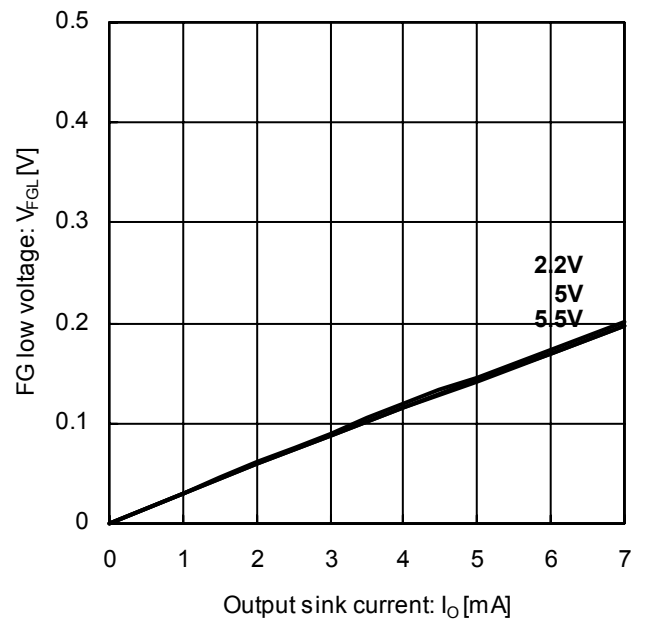

Figure 10. FG low voltage (Temp=25°C)

Typical Performance Curves 3

(Reference data)

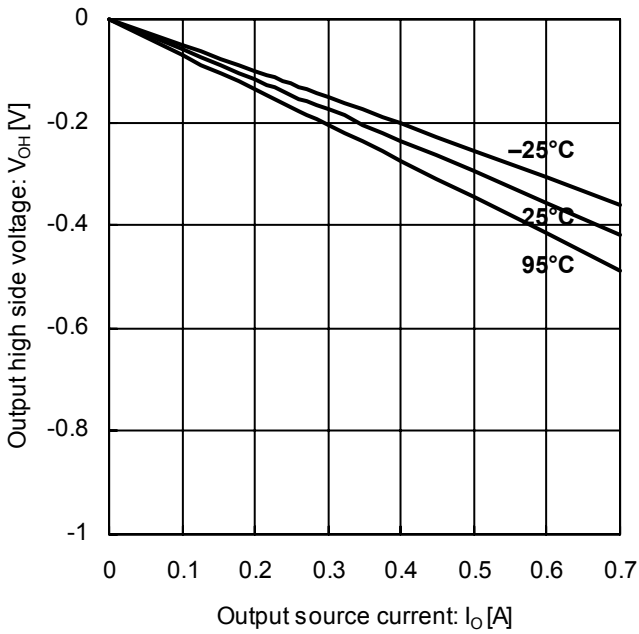

Figure 11. Output high side voltage ($V_{CC}=5\text{V}$)

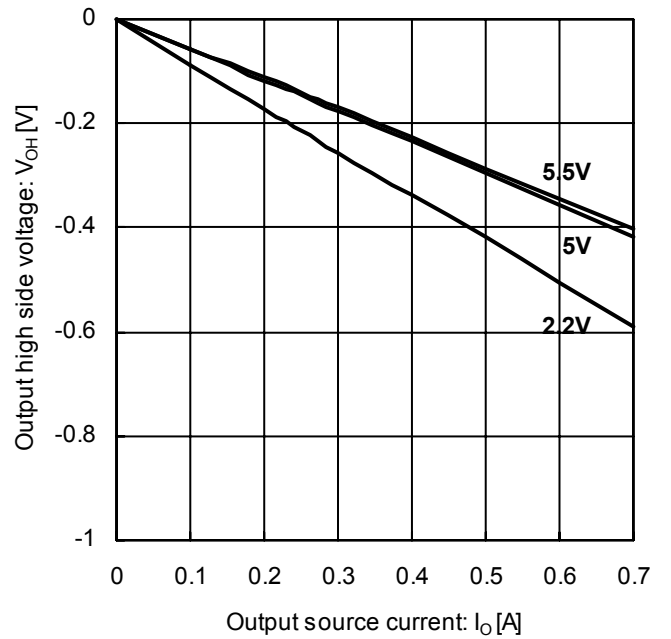

Figure 12. Output high side voltage (Temp= 25°C)

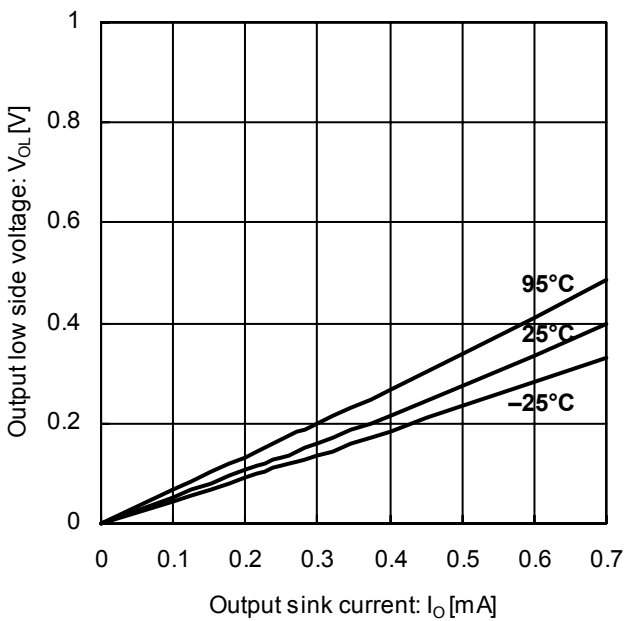

Figure 13. Output low side voltage ($V_{CC}=5\text{V}$)

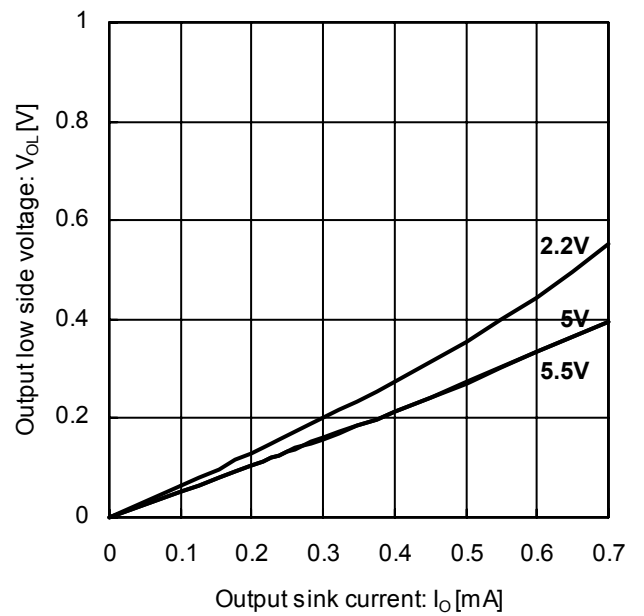

Figure 14. Output low side voltage (Temp= 25°C)

Typical Performance Curves 4
(Reference data)

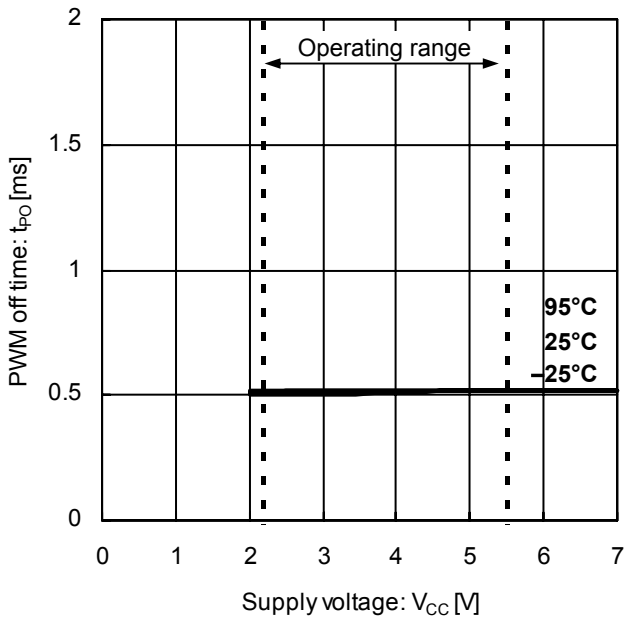

Figure 15. PWM off time

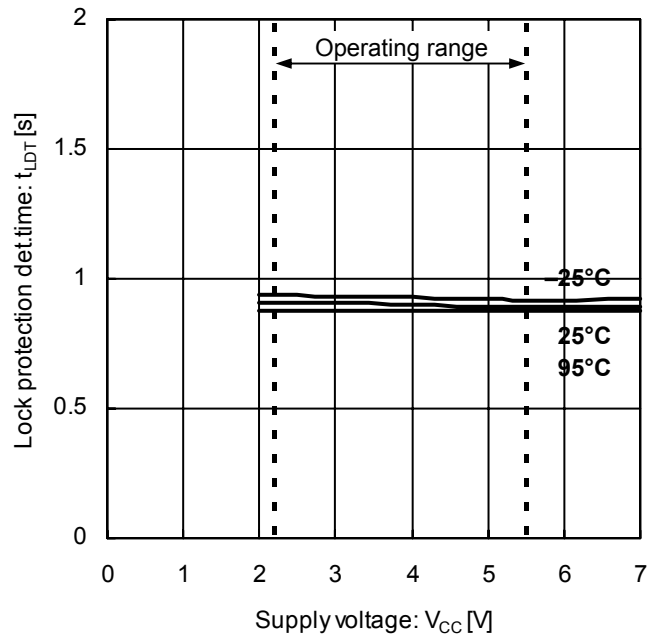

Figure 16. Lock protection det.time

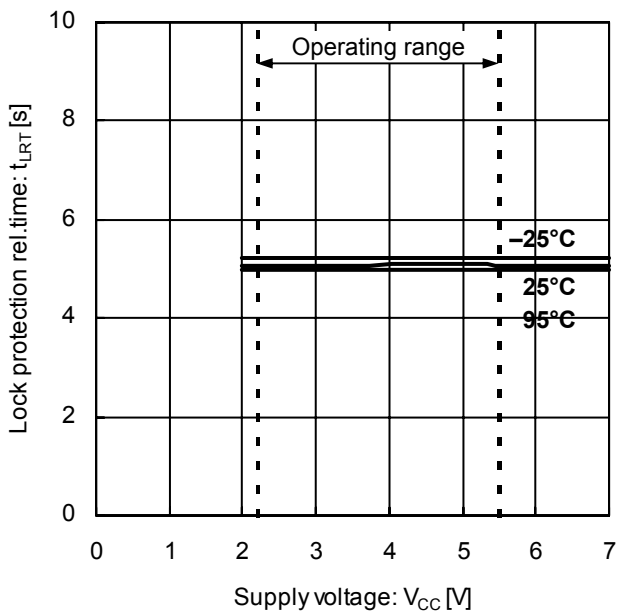

Figure 17. Lock protection rel.time

Timing chart

1) Sensorless Drive

BD6326NUX is a motor driver IC for driving a three-phase brushless DC motor without a hall sensor. Detecting a rotor location firstly at startup, an appropriate logic for the rotation direction is obtained using this information and given to each phase to rotate the motor. Then, the rotation of the motor induces electromotive voltage in each phase wiring and the logic based on the induced electromotive voltage is applied to the each phase to continue rotating.

1.1 BEMF detection driving mechanism (synchronized start-up mechanism)

BD6326NUX's start mechanism is synchronized start-up mechanism. BD6326NUX as BEMF detection driving starts by set output logic and monitors BEMF voltage of motor. Driving mechanism changes to BEMF detection driving after detect BEMF signal. When BEMF signal isn't detected for constant time at start-up, synchronized start-up mechanism outputs output logic forcibly by using standard synchronized signal (sync signal) and makes motor forward drive. This assistance of motor start-up as constant cycle is synchronized driving mechanism. Synchronized frequency is standard synchronized signal. Figure 18, the timing chart (outline) is shown. "Motor start-up frequency setting" generation of synchronized period is shown.

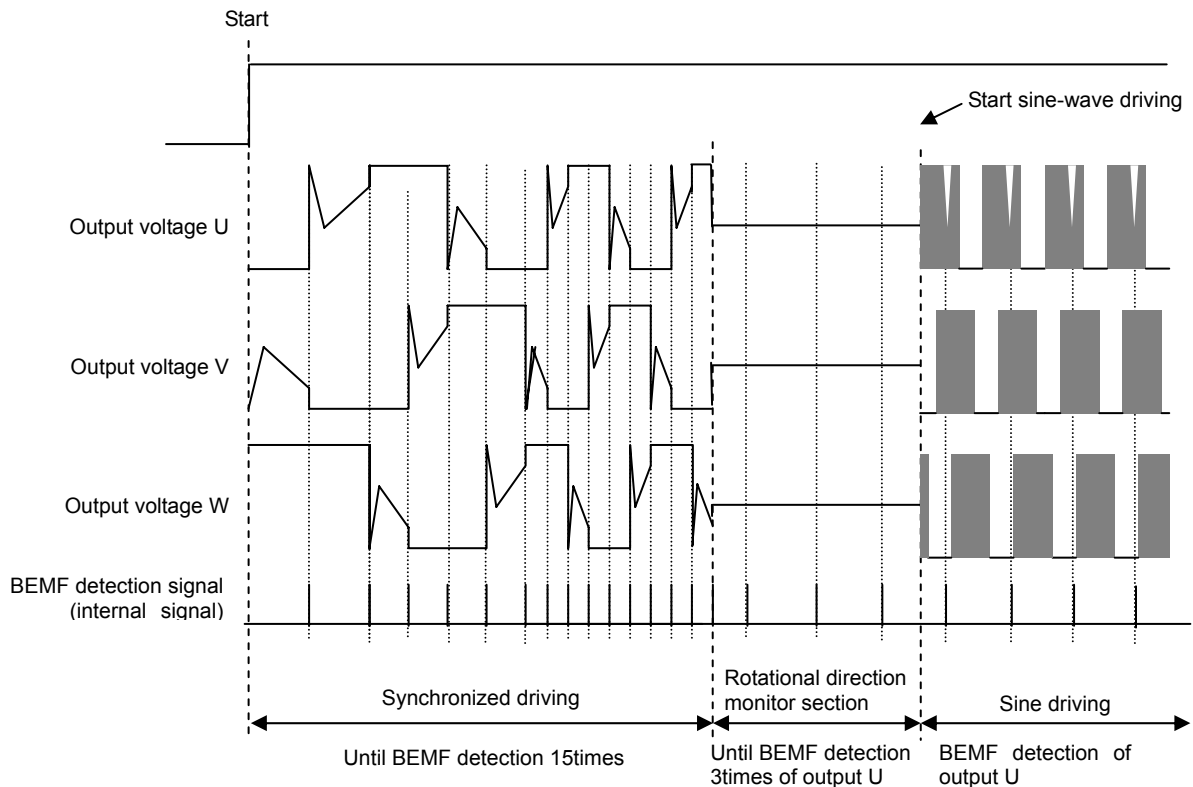

Figure 18. Timing chart at startup

Table 1. Setting of electrify angle and output duty while start-up

	Number of BEMF detection (from start-up)			
	Start-up	Until BEMF (output U,V,W) detection 15times successively	Until BEMF detection 3times of output U	After BEMF detection 3times of output U (after BEMF monitor section)
Synchronized time		8000 × TOSC	Output off mode (BEMF monitor section)	
PWM duty		PWM = fixed 100%		PWM control
Electrify angle		150° drive		Sine-wave

* Disagree with above timing chart

1.2 Motor start-up frequency setting (TOSC capacitor)

The TOSC terminal starts a self-oscillation by connecting a capacitor between the TOSC terminal and GND. It becomes a start-up frequency, and synchronized time. Synchronized time can be adjusted by changing external capacitor. When the capacitor value is small, synchronized time becomes short. It is necessary to choose the best capacitor value for optimum start-up operation. For example external capacitor is 2200pF, synchronized time is 200ms (Typ). 1000pF is recommended for setting value at first. Relationship between external capacitor and synchronized time is shown in below.

< Diagram of Relationship between TOSC terminal and synchronized time >

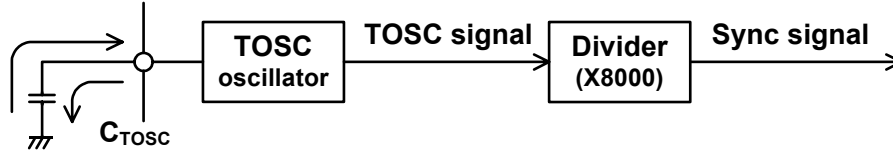

Synchronized time = 8000 x TOSC period
 Charge current : 100μA discharge current : 100μA

Figure 19. TOSC terminal and synchronized time

Equation

$$T_{osc} = 2x \frac{C_{TOSC} V_{TOSC}}{I}$$

C_{TOSC} : TOSC terminal capacitor value
 V_{TOSC} : TOSC terminal Hi voltage – Lo voltage= 0.57V (Typ)
 I : TOSC terminal charge and discharge current

Example

C_{TOSC} = 2200pF
 TOSC frequency = 40kHz (Typ)
 TOSC period = 25μs
 Synchronized time = 200ms

Table 2. Capacitor values and synchronized time

External capacitor	Synchronized time
2200pF	200ms
1000pF (Recommendation)	90ms
670pF	60ms

※Setting of Appropriate capacitor value

Appropriate value of synchronized time is differing with characteristic and parameter of motor. Appropriate value decided by start-up confirmation with various capacitor values.

At first confirm start-up with 1000pF, next is 1200,1500,2200pF···,and 820,680pF···etc. Appropriate capacitor value is decided after confirm maximum start-up NG value and minimum start-up NG value. For example, small BEMF voltage motor tends to small capacitor value. Set capacitor value after confirm sufficiently.

1.3 U, V, W phase and FG output signals

The timing charts of the output signals from the U, V and W phases as well as the FG terminal (at FR = Hi or no connected) is shown (Figure 20).

The detection of the BEMF voltage does with output U and detects the position of the motor rotation. The three phases are driving in the order of U, V and W phases. About FG signal output, assuming that a three-slot tetrode motor is used, two pulse outputs of FG are produced for one motor cycle.

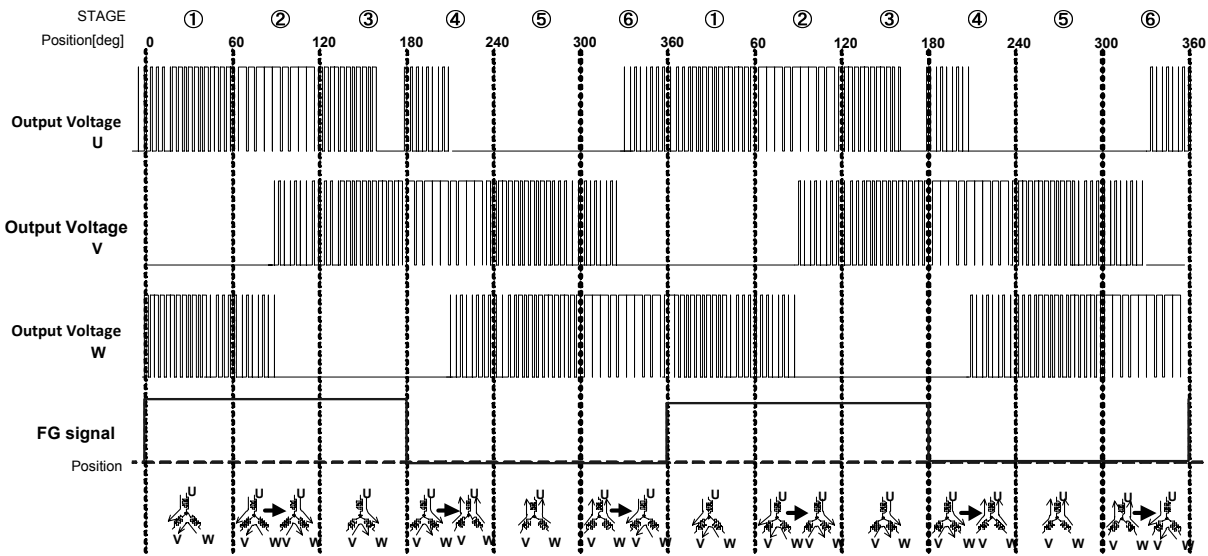

Figure 20. Timing chart of U, V, W, FG output signal (FR= Hi or no connect)

Table 3. Truth table of normal operation

Output pattern	Motor output		
	Motor output U	Motor output V	Motor output W
1	PWM	L	PWM
2	PWM	L→PWM	PWM→L
3	PWM→Hi-Z (BEMF detect)	PWM	L
4	PWM→L	PWM	L→PWM
5	L	PWM	PWM
6	L→PWM	PWM→L	PWM

* About the output pattern, It changes in the flow of "1→2→3 ~ 6→1".
 H; High, L; Low, Hi-Z; High impedance

FG signal is masked between synchronized driving section (FG = Hi level). The FG signal is output from Rotation speed monitor section.

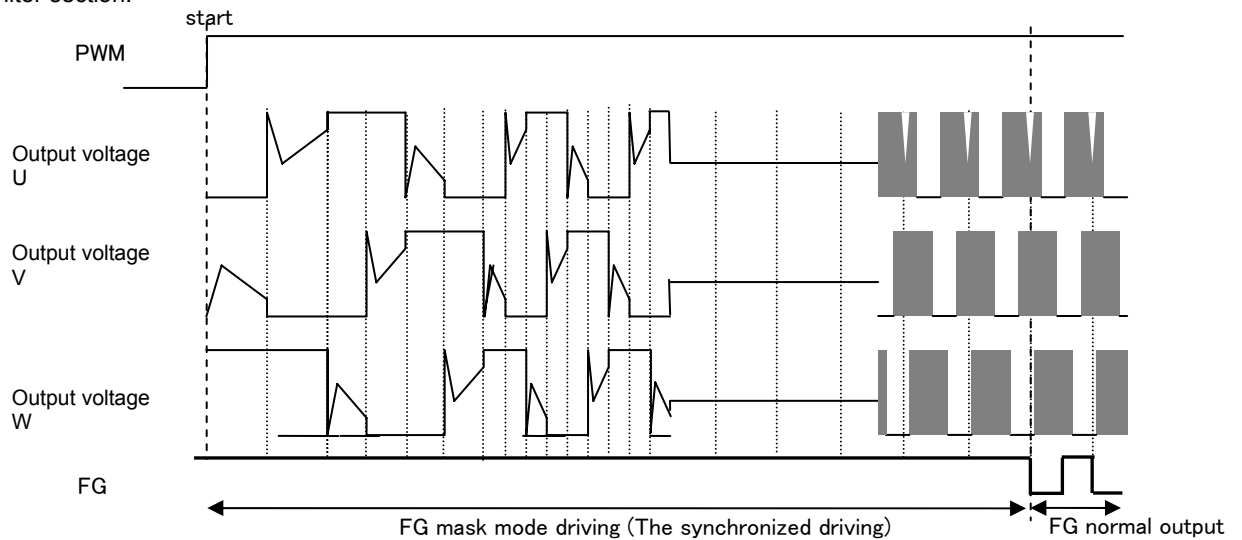

Figure 21. About FG mask section

2) UVLO (Under voltage lock out circuit)

In the operation area under the guaranteed operating power supply voltage of 2.2 V (Typ), the transistor on the output can be turned OFF at a power supply voltage of 1.73V (Typ). A hysteresis width of 270mV is provided and a normal operation can be performed at 2.0V. This function is installed to prevent unpredictable operations, such as a large amount of current passing through the output, by means of intentionally turning OFF the output during an operation at a very low power supply voltage which may cause an abnormal function in the internal circuit.

3) Lock Protection Feature (motor stop at start-up), Automatic Recovery Circuit

To prevent passing a coil current on any phase when a motor is locked, it is provided with a function which can turn OFF the output for a certain period of time and then automatically restore itself to the normal operation. During the motor rotation, an appropriate logic based on the induced electromotive voltage can be continuously given to each phase; on the other hand, when the motor is locked at, no induced electromotive voltage is obtained. Utilizing this phenomenon to take a protective against locking, when the induced electromotive voltage is not detected for a predetermined period of time (TON: 0.9sec(Typ)), it is judged that the motor is locked and the output is turned OFF for a predetermined period of time (TOFF: 5.0sec(Typ)).

Moreover, if Synchronized driving doesn't change into Rotational speed monitor section between TON (0.9sec(Typ)) at start-up, it is judged that the motor is locked. The timing chart is shown (Figure 22).

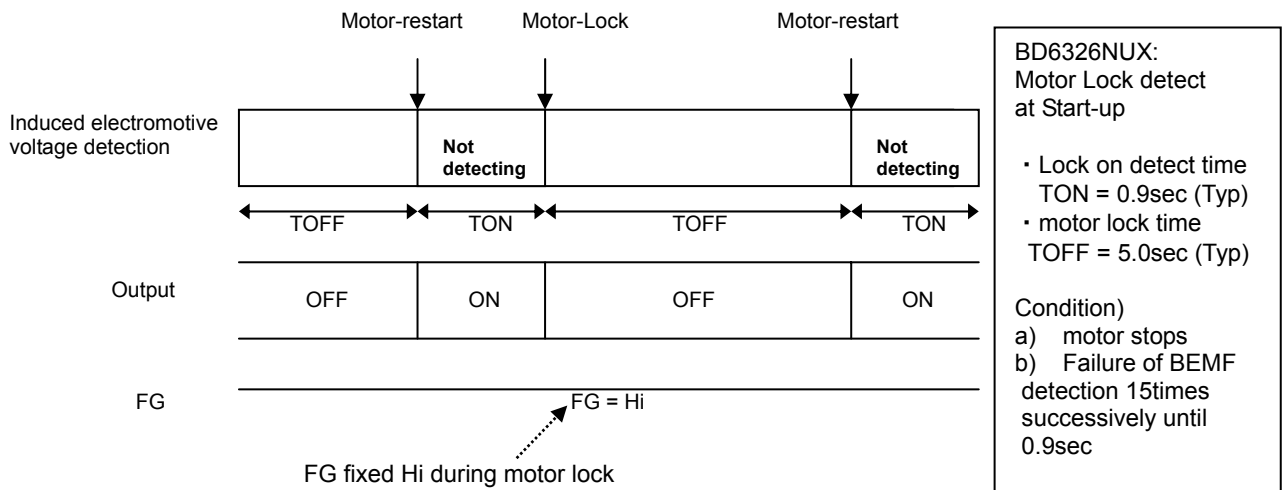

Figure 22. Lock protection operation

4) Power saving function / Speed control by PWM input

The power saving function is controlled by an input logic of the PWM terminal.

(a) Perate mode when the PWM terminal is High.

(b) Standby mode when the PWM terminal is Low for a time period of 1ms (Typ).

When the PWM terminal is open, High logic is set.

Input logic of the PWM terminal is set at Low and then the Standby mode becomes effective 1ms (Typ) (Figure 23). In the Standby mode, the lock protection function is deactivated and the lock protection is not effective. Therefore, this device can start up instantly even from the stop state when the input logic of the PWM terminal is set at High.

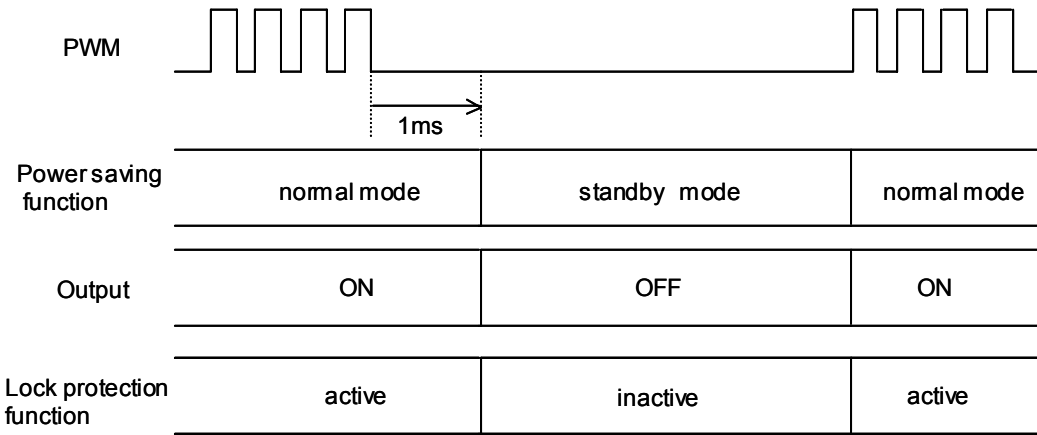

Figure 23. The power saving function

• Speed Control by PWM input

Depending on the Duty value of the input signal on the PWM terminal, the output is controlled by switching between ON and OFF. The higher Duty value results in the higher motor rotation speed, while the lower Duty values the lower speed.

5) Pole select (FG signal select terminal)

The FR terminal selects motor rotation direction (Table 4).

Table 4. FR table

FR	Rotation Direction
High (or open)	Normal Rotation
Low	Reverse Rotation

Application circuit example (Constant values are for reference)

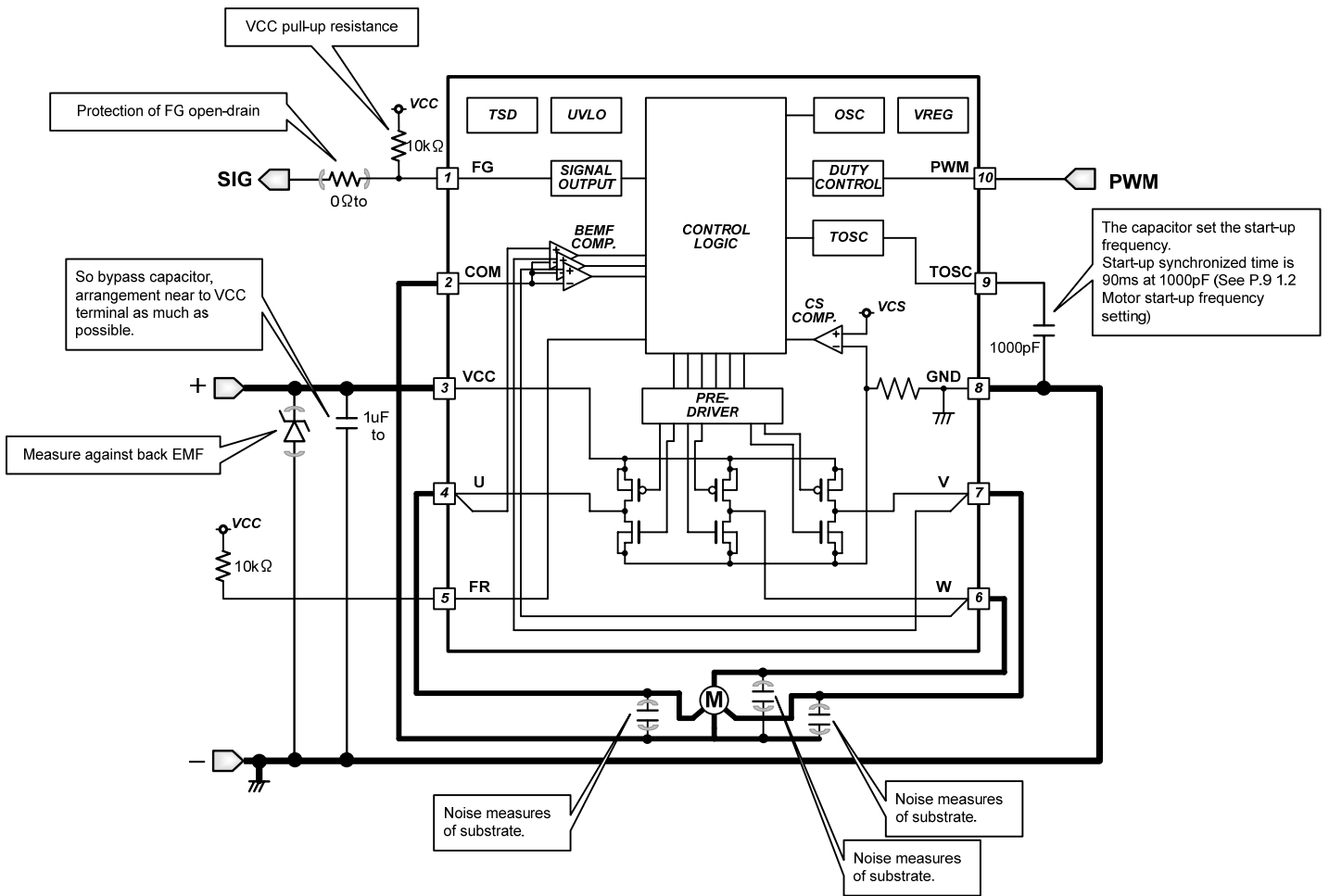

Figure 24. PWM controllable 4 wires type (FG) motor application circuit

Substrate design note

- a) IC power, motor outputs, and IC ground lines are made as fat as possible.
- b) IC ground (signal ground) line arranged near to (-) land.
- c) The bypass capacitor is arrangement near to VCC terminal.
- d) When substrates of outputs are noisy, add capacitor as needed.
- e) When back EMF is large, add zener diode as needed.

Power dissipation

Power dissipation (total loss) indicates the power that can be consumed by IC at Ta = 25°C (normal temperature). IC is heated when it consumes power, and the temperature of IC chip becomes higher than ambient temperature. The temperature that can be accepted by IC chip depends on circuit configuration, manufacturing process, etc., and consumable power is limited. Power dissipation is determined by the temperature allowed in IC chip (maximum junction temperature) and thermal resistance of package (heat dissipation capability). The maximum junction temperature is in general equal to the maximum value in the storage temperature range.

Heat generated by consumed power of IC is radiated from the mold resin or lead frame of package. The parameter which indicates this heat dissipation capability (hardness of heat release) is called heat resistance, represented by the symbol θ_{ja} [°C/W]. This heat resistance can estimate the temperature of IC inside the package. Figure 25 shows the model of heat resistance of the package. Heat resistance θ_{ja} , ambient temperature Ta, junction temperature Tj, and power consumption P can be calculated by the equation below:

$$\theta_{ja} = (T_j - T_a) / P \text{ [°C/W]}$$

Thermal de-rating curve indicates power that can be consumed by IC with reference to ambient temperature. Power that can be consumed by IC begins to attenuate at certain ambient temperature. This gradient is determined by thermal resistance θ_{ja} . Thermal resistance θ_{ja} depends on chip size, power consumption, package ambient temperature, packaging condition, wind velocity, etc., even when the same package is used. Thermal de-rating curve indicates a reference value measured at a specified condition. Figure 26 shows a thermal de-rating curve (Value when mounting FR4 glass epoxy board 74.2 [mm] x 74.2 [mm] x 1.6 [mm] (copper foil area below 3 [%])). Thermal resistance θ_{jc} from IC chip joint part to the package surface part of mounting the above-mentioned same substrate is shown in the following as a reference value.

$$\theta_{jc} = 40 \text{ [°C/W]}$$

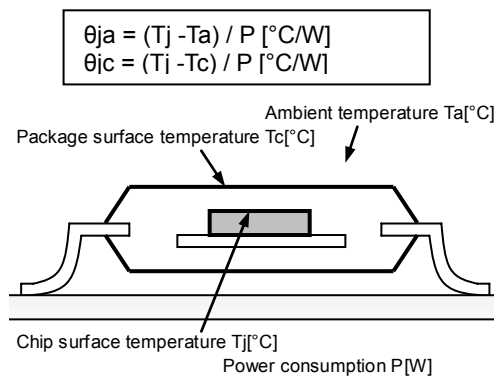
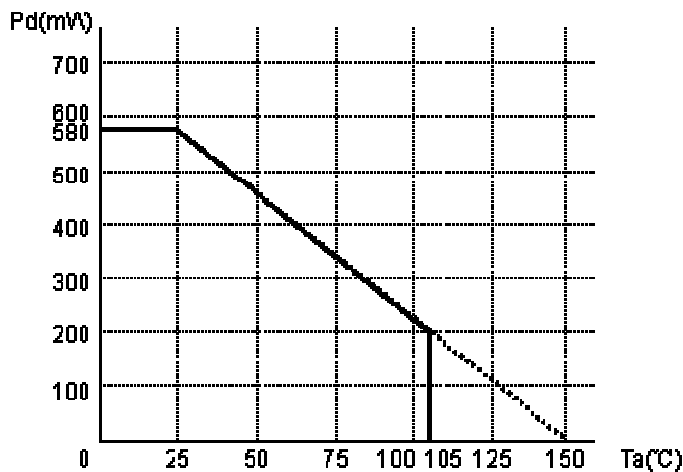

Figure 25. Thermal resistance



* 1 Above Ta = 25°C, derating by 4.64 mW/°C
(When glass epoxy board (single layer) of 74.2 mm x 74.2 mm x 1.6 mm is mounted)

Figure 26. Thermal de-rating curve

Safety measure

1) Reverse connection protection diode

Reverse connection of power results in IC destruction as shown in Figure 27. When reverse connection is possible, reverse connection destruction preventive diode must be added between power supply and VCC.

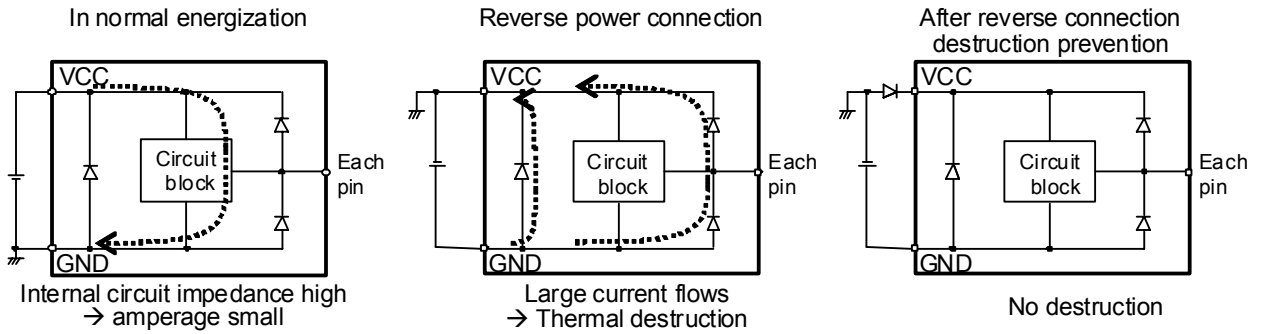

Figure 27. Flow of current when power is connected reversely

2) Measure against VCC voltage rise by back electromotive force

Back electromotive force (Back EMF) generates regenerative current to power supply. However, when reverse connection protection diode is connected, VCC voltage rises because no route is available for regenerating to power.

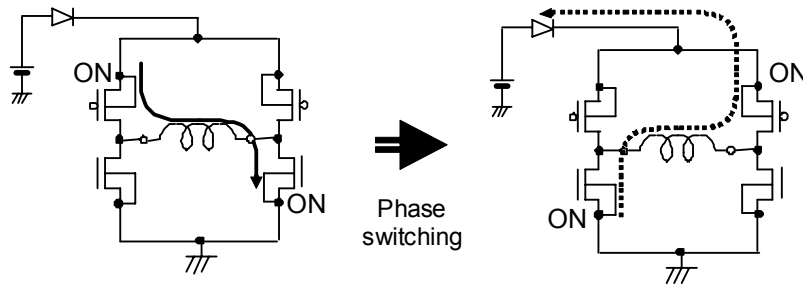

Figure 28. VCC voltage rise by back electromotive force

When the absolute maximum rated voltage may be exceeded due to voltage rise by back electromotive force, place (A) Capacitor or (B) Zener diode between VCC and GND. In addition, also take the measure (A) and (B) as shown in (C) if required.

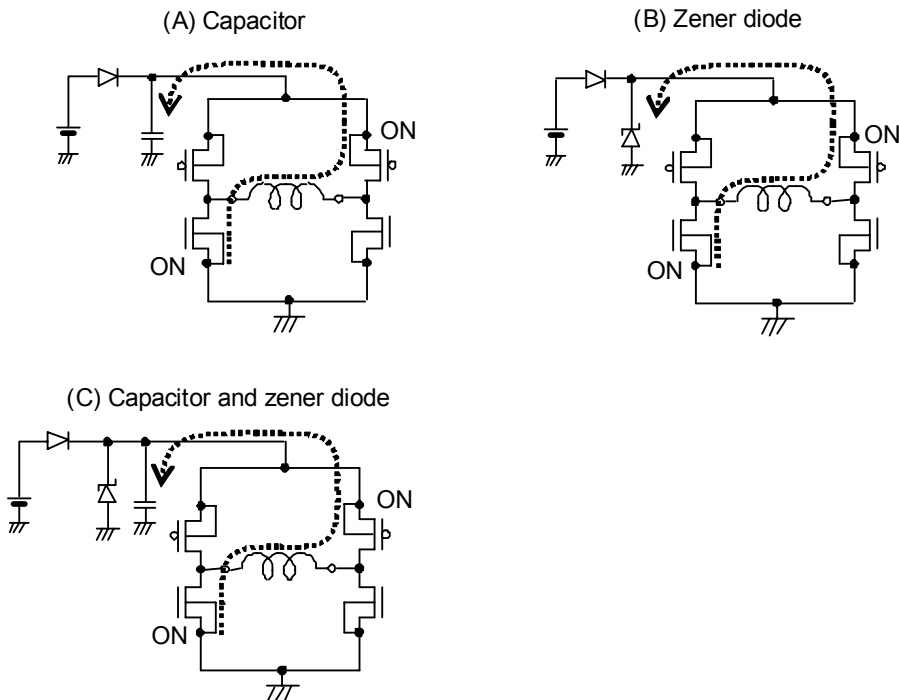

Figure 29. Measure against VCC voltage rise

3) Problem of GND line PWM switching

Do not perform PWM switching of GND line because the potential of GND terminal cannot be kept at the minimum.

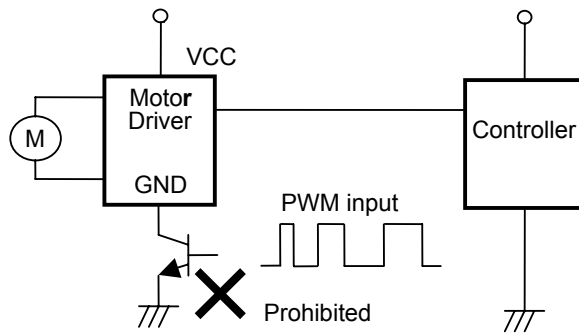

Figure 30. GND Line PWM switching prohibited

4) FG output

FG output is an open drain and requires pull-up resistor.

The IC can be protected by adding resistor R1. An excess of absolute maximum rating, when FG output terminal is directly connected to power supply, could damage the IC.

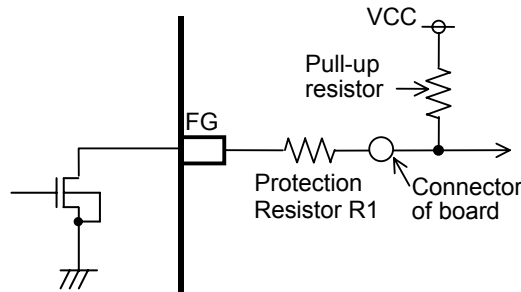

Figure 31. Protection of FG terminal

Location of IC

1) Generally, three-phase sensorless driver is rotated motor by detecting the induced electromotive voltage. Line noise, line resistance is influenced for detecting the induced electromotive voltage. From motor to IC line should be shorted, its suggest that location of IC is on the board of Motor in below Figure 32.

2) In three-phase sensorless and variable speed driver, it is necessary to tuning motor and IC (each motor units).

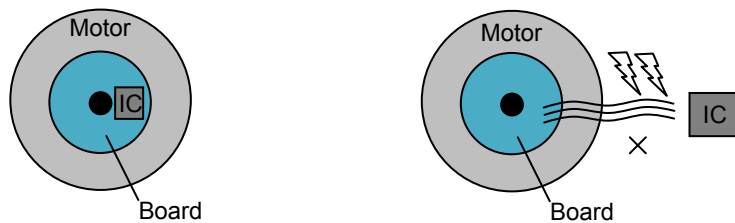
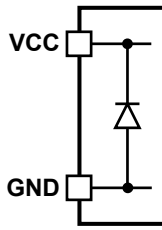

Figure 32. Location of IC

I/O equivalent circuits (Resistance is typical.)

1) Power supply terminal, and ground terminal



2) Output duty controllable input terminal

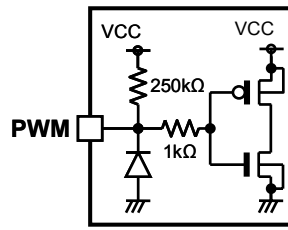

3) Motor rotation direction select input terminal

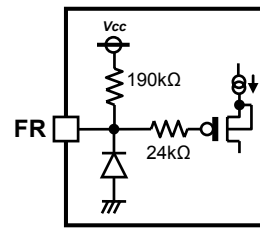

4) Start-up oscillation control terminal

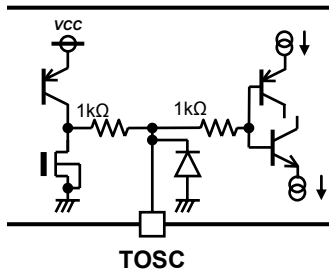

5) Speed pulse signal output terminal

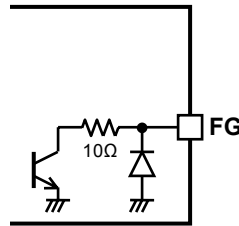

6) Motor coil midpoint input terminal

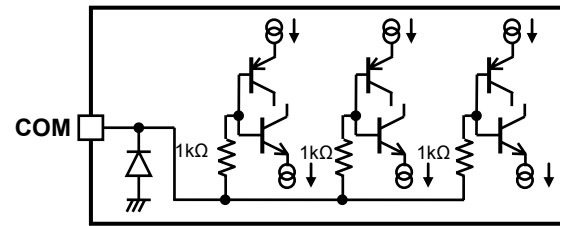

7) Motor output terminal

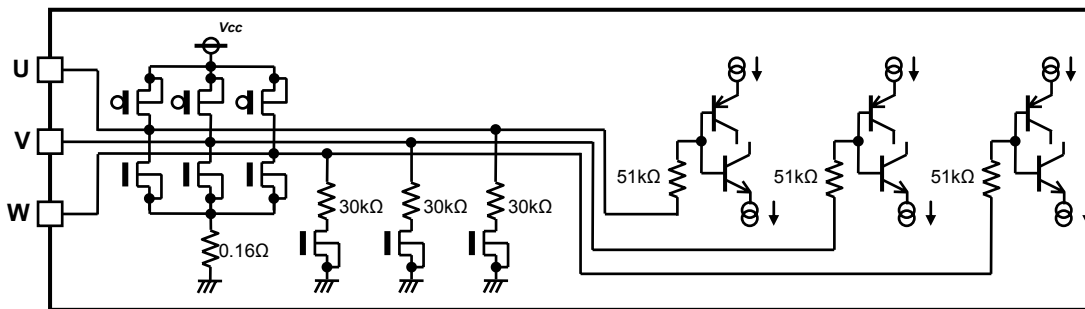

Figure 33. I/O equivalent circuits

Operational Notes

- Reverse Connection of Power Supply**

Connecting the power supply in reverse polarity can damage the IC. Take precautions against reverse polarity when connecting the power supply, such as mounting an external diode between the power supply and the IC's power supply pins.
- Power Supply Lines**

Design the PCB layout pattern to provide low impedance supply lines. Separate the ground and supply lines of the digital and analog blocks to prevent noise in the ground and supply lines of the digital block from affecting the analog block. Furthermore, connect a capacitor to ground at all power supply pins. Consider the effect of temperature and aging on the capacitance value when using electrolytic capacitors.
- Ground Voltage**

Ensure that no pins are at a voltage below that of the ground pin at any time, even during transient condition. However, pins that drive inductive loads (e.g. motor driver outputs, DC-DC converter outputs) may inevitably go below ground due to back EMF or electromotive force. In such cases, the user should make sure that such voltages going below ground will not cause the IC and the system to malfunction by examining carefully all relevant factors and conditions such as motor characteristics, supply voltage, operating frequency and PCB wiring to name a few.
- Ground Wiring Pattern**

When using both small-signal and large-current ground traces, the two ground traces should be routed separately but connected to a single ground at the reference point of the application board to avoid fluctuations in the small-signal ground caused by large currents. Also ensure that the ground traces of external components do not cause variations on the ground voltage. The ground lines must be as short and thick as possible to reduce line impedance.
- Thermal Consideration**

Should by any chance the power dissipation rating be exceeded the rise in temperature of the chip may result in deterioration of the properties of the chip. In case of exceeding this absolute maximum rating, increase the board size and copper area to prevent exceeding the Pd rating.
- Recommended Operating Conditions**

These conditions represent a range within which the expected characteristics of the IC can be approximately obtained. The electrical characteristics are guaranteed under the conditions of each parameter.
- Inrush Current**

When power is first supplied to the IC, it is possible that the internal logic may be unstable and inrush current may flow instantaneously due to the internal powering sequence and delays, especially if the IC has more than one power supply. Therefore, give special consideration to power coupling capacitance, power wiring, width of ground wiring, and routing of connections.
- Operation Under Strong Electromagnetic Field**

Operating the IC in the presence of a strong electromagnetic field may cause the IC to malfunction.
- Testing on Application Boards**

When testing the IC on an application board, connecting a capacitor directly to a low-impedance output pin may subject the IC to stress. Always discharge capacitors completely after each process or step. The IC's power supply should always be turned off completely before connecting or removing it from the test setup during the inspection process. To prevent damage from static discharge, ground the IC during assembly and use similar precautions during transport and storage.

Operational Notes

10. Inter-pin Short and Mounting Errors

Ensure that the direction and position are correct when mounting the IC on the PCB. Incorrect mounting may result in damaging the IC. Avoid nearby pins being shorted to each other especially to ground, power supply and output pin. Inter-pin shorts could be due to many reasons such as metal particles, water droplets (in very humid environment) and unintentional solder bridge deposited in between pins during assembly to name a few.

11. Unused Input Pins

Input pins of an IC are often connected to the gate of a MOS transistor. The gate has extremely high impedance and extremely low capacitance. If left unconnected, the electric field from the outside can easily charge it. The small charge acquired in this way is enough to produce a significant effect on the conduction through the transistor and cause unexpected operation of the IC. So unless otherwise specified, unused input pins should be connected to the power supply or ground line.

12. Regarding the Input Pin of the IC

This monolithic IC contains P+ isolation and P substrate layers between adjacent elements in order to keep them isolated. P-N junctions are formed at the intersection of the P layers with the N layers of other elements, creating a parasitic diode or transistor. For example (refer to figure below):

When $GND > Pin A$ and $GND > Pin B$, the P-N junction operates as a parasitic diode.

When $GND > Pin B$, the P-N junction operates as a parasitic transistor.

Parasitic diodes inevitably occur in the structure of the IC. The operation of parasitic diodes can result in mutual interference among circuits, operational faults, or physical damage. Therefore, conditions that cause these diodes to operate, such as applying a voltage lower than the GND voltage to an input pin (and thus to the P substrate) should be avoided.

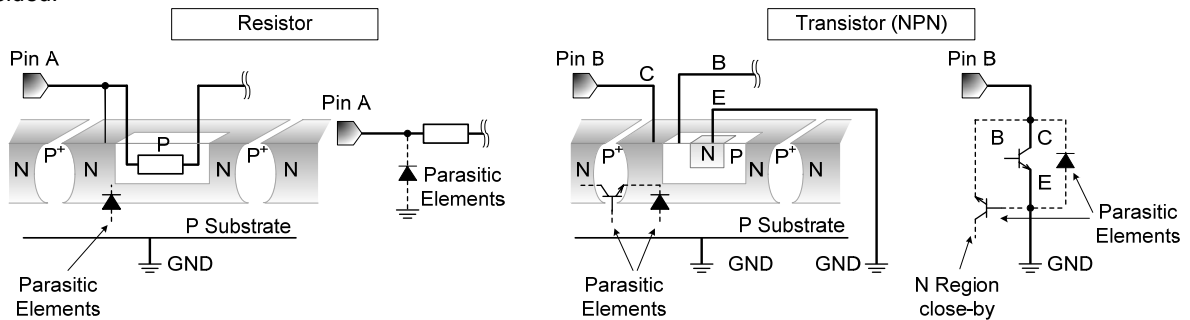

Figure 34. Example of monolithic IC structure

13. Ceramic Capacitor

When using a ceramic capacitor, determine the dielectric constant considering the change of capacitance with temperature and the decrease in nominal capacitance due to DC bias and others.

14. Area of Safe Operation (ASO)

Operate the IC such that the output voltage, output current, and power dissipation are all within the Area of Safe Operation (ASO).

15. Thermal Shutdown (TSD) Circuit

This IC has a built-in thermal shutdown circuit that prevents heat damage to the IC. Normal operation should always be within the IC's power dissipation rating. If however the rating is exceeded for a continued period, the junction temperature will rise which will activate the TSD circuit that will turn OFF all output pins. When the junction temperature falls below the TSD threshold, the circuits are automatically restored to normal operation.

Note that the TSD circuit operates in a situation that exceeds the absolute maximum ratings and therefore, under no circumstances, should the TSD circuit be used in a set design or for any purpose other than protecting the IC from heat damage.

Ordering Information

B D 6 3 2 6 N U X

E 2

Part Number
BD6326

Package
NUX: VSON010X3030

Packaging and forming specification
E2: Embossed tape and reel

Marking diagram

VSON010X3030 (TOP VIEW)

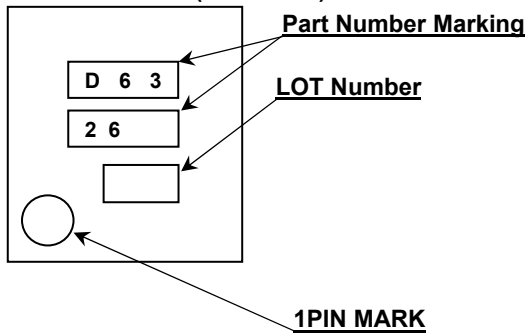

Physical Dimension Tape and Reel Information

Package Name	VSON010V3030
---------------------	---------------------

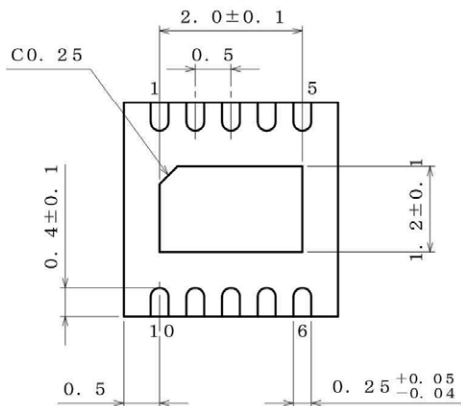
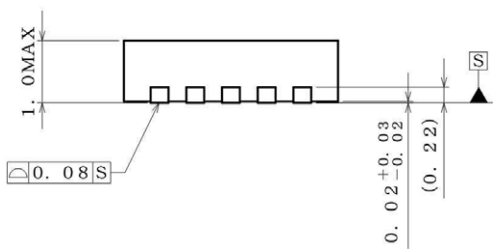
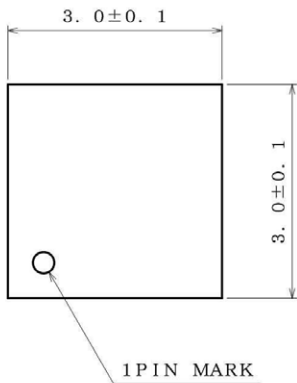

(UNIT : mm)
 PKG : VSON010V3030
 Drawing No. EX184-5001-1

<Tape and Reel information>

Tape	Embossed carrier tape
Quantity	3000pcs
Direction of feed	E2 (The direction is the 1pin of product is at the upper left when you hold reel on the left hand and you pull out the tape on the right hand)

1pin

* Order quantity needs to be multiple of the minimum quantity.

Revision History

Date	Revision	Changes
7. May. 2013	001	New Release
11.Dec.2014	002	Changed the latest format

Notice

Precaution on using ROHM Products

- Our Products are designed and manufactured for application in ordinary electronic equipments (such as AV equipment, OA equipment, telecommunication equipment, home electronic appliances, amusement equipment, etc.). If you intend to use our Products in devices requiring extremely high reliability (such as medical equipment ^(Note 1), transport equipment, traffic equipment, aircraft/spacecraft, nuclear power controllers, fuel controllers, car equipment including car accessories, safety devices, etc.) and whose malfunction or failure may cause loss of human life, bodily injury or serious damage to property ("Specific Applications"), please consult with the ROHM sales representative in advance. Unless otherwise agreed in writing by ROHM in advance, ROHM shall not be in any way responsible or liable for any damages, expenses or losses incurred by you or third parties arising from the use of any ROHM's Products for Specific Applications.

(Note1) Medical Equipment Classification of the Specific Applications

JAPAN	USA	EU	CHINA
CLASS III	CLASS III	CLASS II b	CLASS III
CLASS IV		CLASS III	

- ROHM designs and manufactures its Products subject to strict quality control system. However, semiconductor products can fail or malfunction at a certain rate. Please be sure to implement, at your own responsibilities, adequate safety measures including but not limited to fail-safe design against the physical injury, damage to any property, which a failure or malfunction of our Products may cause. The following are examples of safety measures:
 - Installation of protection circuits or other protective devices to improve system safety
 - Installation of redundant circuits to reduce the impact of single or multiple circuit failure
- Our Products are designed and manufactured for use under standard conditions and not under any special or extraordinary environments or conditions, as exemplified below. Accordingly, ROHM shall not be in any way responsible or liable for any damages, expenses or losses arising from the use of any ROHM's Products under any special or extraordinary environments or conditions. If you intend to use our Products under any special or extraordinary environments or conditions (as exemplified below), your independent verification and confirmation of product performance, reliability, etc. prior to use, must be necessary:
 - Use of our Products in any types of liquid, including water, oils, chemicals, and organic solvents
 - Use of our Products outdoors or in places where the Products are exposed to direct sunlight or dust
 - Use of our Products in places where the Products are exposed to sea wind or corrosive gases, including Cl₂, H₂S, NH₃, SO₂, and NO₂
 - Use of our Products in places where the Products are exposed to static electricity or electromagnetic waves
 - Use of our Products in proximity to heat-producing components, plastic cords, or other flammable items
 - Sealing or coating our Products with resin or other coating materials
 - Use of our Products without cleaning residue of flux (even if you use no-clean type fluxes, cleaning residue of flux is recommended); or Washing our Products by using water or water-soluble cleaning agents for cleaning residue after soldering
 - Use of the Products in places subject to dew condensation
- The Products are not subject to radiation-proof design.
- Please verify and confirm characteristics of the final or mounted products in using the Products.
- In particular, if a transient load (a large amount of load applied in a short period of time, such as pulse. is applied, confirmation of performance characteristics after on-board mounting is strongly recommended. Avoid applying power exceeding normal rated power; exceeding the power rating under steady-state loading condition may negatively affect product performance and reliability.
- De-rate Power Dissipation (Pd) depending on Ambient temperature (Ta). When used in sealed area, confirm the actual ambient temperature.
- Confirm that operation temperature is within the specified range described in the product specification.
- ROHM shall not be in any way responsible or liable for failure induced under deviant condition from what is defined in this document.

Precaution for Mounting / Circuit board design

- When a highly active halogenous (chlorine, bromine, etc.) flux is used, the residue of flux may negatively affect product performance and reliability.
- In principle, the reflow soldering method must be used on a surface-mount products, the flow soldering method must be used on a through hole mount products. If the flow soldering method is preferred on a surface-mount products, please consult with the ROHM representative in advance.

For details, please refer to ROHM Mounting specification

Precautions Regarding Application Examples and External Circuits

1. If change is made to the constant of an external circuit, please allow a sufficient margin considering variations of the characteristics of the Products and external components, including transient characteristics, as well as static characteristics.
2. You agree that application notes, reference designs, and associated data and information contained in this document are presented only as guidance for Products use. Therefore, in case you use such information, you are solely responsible for it and you must exercise your own independent verification and judgment in the use of such information contained in this document. ROHM shall not be in any way responsible or liable for any damages, expenses or losses incurred by you or third parties arising from the use of such information.

Precaution for Electrostatic

This Product is electrostatic sensitive product, which may be damaged due to electrostatic discharge. Please take proper caution in your manufacturing process and storage so that voltage exceeding the Products maximum rating will not be applied to Products. Please take special care under dry condition (e.g. Grounding of human body / equipment / solder iron, isolation from charged objects, setting of Ionizer, friction prevention and temperature / humidity control).

Precaution for Storage / Transportation

1. Product performance and soldered connections may deteriorate if the Products are stored in the places where:
 - [a] the Products are exposed to sea winds or corrosive gases, including Cl₂, H₂S, NH₃, SO₂, and NO₂
 - [b] the temperature or humidity exceeds those recommended by ROHM
 - [c] the Products are exposed to direct sunshine or condensation
 - [d] the Products are exposed to high Electrostatic
2. Even under ROHM recommended storage condition, solderability of products out of recommended storage time period may be degraded. It is strongly recommended to confirm solderability before using Products of which storage time is exceeding the recommended storage time period.
3. Store / transport cartons in the correct direction, which is indicated on a carton with a symbol. Otherwise bent leads may occur due to excessive stress applied when dropping of a carton.
4. Use Products within the specified time after opening a humidity barrier bag. Baking is required before using Products of which storage time is exceeding the recommended storage time period.

Precaution for Product Label

QR code printed on ROHM Products label is for ROHM's internal use only.

Precaution for Disposition

When disposing Products please dispose them properly using an authorized industry waste company.

Precaution for Foreign Exchange and Foreign Trade act

Since our Products might fall under controlled goods prescribed by the applicable foreign exchange and foreign trade act, please consult with ROHM representative in case of export.

Precaution Regarding Intellectual Property Rights

1. All information and data including but not limited to application example contained in this document is for reference only. ROHM does not warrant that foregoing information or data will not infringe any intellectual property rights or any other rights of any third party regarding such information or data. ROHM shall not be in any way responsible or liable for infringement of any intellectual property rights or other damages arising from use of such information or data.:
2. No license, expressly or implied, is granted hereby under any intellectual property rights or other rights of ROHM or any third parties with respect to the information contained in this document.

Other Precaution

1. This document may not be reprinted or reproduced, in whole or in part, without prior written consent of ROHM.
2. The Products may not be disassembled, converted, modified, reproduced or otherwise changed without prior written consent of ROHM.
3. In no event shall you use in any way whatsoever the Products and the related technical information contained in the Products or this document for any military purposes, including but not limited to, the development of mass-destruction weapons.
4. The proper names of companies or products described in this document are trademarks or registered trademarks of ROHM, its affiliated companies or third parties.

General Precaution

1. Before you use our Products, you are requested to carefully read this document and fully understand its contents. ROHM shall not be in any way responsible or liable for failure, malfunction or accident arising from the use of any ROHM's Products against warning, caution or note contained in this document.
2. All information contained in this document is current as of the issuing date and subject to change without any prior notice. Before purchasing or using ROHM's Products, please confirm the latest information with a ROHM sales representative.
3. The information contained in this document is provided on an "as is" basis and ROHM does not warrant that all information contained in this document is accurate and/or error-free. ROHM shall not be in any way responsible or liable for any damages, expenses or losses incurred by you or third parties resulting from inaccuracy or errors of or concerning such information.

Mouser Electronics

Authorized Distributor

Click to View Pricing, Inventory, Delivery & Lifecycle Information:

[ROHM Semiconductor:](#)

[BD6326NUX-E2](#)

Компания «Океан Электроники» предлагает заключение долгосрочных отношений при поставках импортных электронных компонентов на взаимовыгодных условиях!

Наши преимущества:

- Поставка оригинальных импортных электронных компонентов напрямую с производств Америки, Европы и Азии, а так же с крупнейших складов мира;
- Широкая линейка поставок активных и пассивных импортных электронных компонентов (более 30 млн. наименований);
- Поставка сложных, дефицитных, либо снятых с производства позиций;
- Оперативные сроки поставки под заказ (от 5 рабочих дней);
- Экспресс доставка в любую точку России;
- Помощь Конструкторского Отдела и консультации квалифицированных инженеров;
- Техническая поддержка проекта, помощь в подборе аналогов, поставка прототипов;
- Поставка электронных компонентов под контролем ВП;
- Система менеджмента качества сертифицирована по Международному стандарту ISO 9001;
- При необходимости вся продукция военного и аэрокосмического назначения проходит испытания и сертификацию в лаборатории (по согласованию с заказчиком);
- Поставка специализированных компонентов военного и аэрокосмического уровня качества (Xilinx, Altera, Analog Devices, Intersil, Interpoint, Microsemi, Actel, Aeroflex, Peregrine, VPT, Syfer, Eurofarad, Texas Instruments, MS Kennedy, Miteq, Cobham, E2V, MA-COM, Hittite, Mini-Circuits, General Dynamics и др.);

Компания «Океан Электроники» является официальным дистрибьютором и эксклюзивным представителем в России одного из крупнейших производителей разъемов военного и аэрокосмического назначения «JONHON», а так же официальным дистрибьютором и эксклюзивным представителем в России производителя высокотехнологичных и надежных решений для передачи СВЧ сигналов «FORSTAR».



JONHON

«JONHON» (основан в 1970 г.)

Разъемы специального, военного и аэрокосмического назначения:

(Применяются в военной, авиационной, аэрокосмической, морской, железнодорожной, горно- и нефтедобывающей отраслях промышленности)

«FORSTAR» (основан в 1998 г.)

ВЧ соединители, коаксиальные кабели,
кабельные сборки и микроволновые компоненты:

(Применяются в телекоммуникациях гражданского и специального назначения, в средствах связи, РЛС, а так же военной, авиационной и аэрокосмической отраслях промышленности).



Телефон: 8 (812) 309-75-97 (многоканальный)

Факс: 8 (812) 320-03-32

Электронная почта: ocean@oceanchips.ru

Web: <http://oceanchips.ru/>

Адрес: 198099, г. Санкт-Петербург, ул. Калинина, д. 2, корп. 4, лит. А