

E5AR Digital Controllers offer high speed, high precision, and multiple I/O and use a 5-digit, 3-row LCD display for high visual clarity.

- A short sampling period of 50 ms enables use in applications requiring high-speed response.
- PV, SP, and MV data is displayed simultaneously in a 3-row, negative LCD display with a backlight.
- Multiloop control, cascade control, and proportional control are possible with a single Controller.
- When using models with CompoWay/F communications, initial settings can be downloaded and settings can be masked using Support Software (CX-Thermo version 4.0 or higher).
- Equipped with calculation functions as a standard (e.g., square root calculation and broken-line approximation).
- DeviceNet Communications
Data setting and monitoring can be performed without special programming.



 Refer to *Safety Precautions for All E5□R Models*.

Refer to *E5AR/E5ER Operation* for operating procedures.

Model Number Structure

Model Number Legend

E5AR-□□□□□□□□□□-□□□□
1 2 3 4 5 6 7 8 9 10

1. Constant Values/Program

None: Constant value

2. Control Method

Blank: Standard or heating/cooling control

P: Position proportional control

3. Output 1

R: DPST-NO relay outputs

Q: Pulse voltage and pulse voltage/current outputs

C: Current and current outputs

4. Output 2

Blank: None

R: Relay outputs

Q: Pulse voltage and pulse voltage/current outputs

C: Current and current outputs

5. Auxiliary Outputs

Blank: None

4: 4PST-NO relay outputs

T: 2 transistor outputs

6. Optional Function 1

Blank: None

3: RS-485 communications

7. Optional Function 2

Blank: None

D: 4 event inputs

8. Input 1

B: Universal-input and 2 event inputs

F: Universal-input and FB

W: Universal-input and universal-input

9. Input 2

Blank: None

W: Universal-input and universal-input

10. Communications Method

Blank: None

FLK: CompoWay/F

DRT: DeviceNet

Note: The above model number legend is intended as a functional description of models. Not all possible combinations of functions are available. Confirm model availability in *Ordering Information* when ordering.

The CX-Thermo Support Software (version 4.0 or higher) can be used to easily set parameters in conversational form.

Note: Be sure to read the precautions for correct use and other precautions in the following user's manual before using the Digital Controller.
E5AR/E5ER Digital Controller User's Manual (Cat. No. Z182)
E5AR/E5ER Digital Controller DeviceNet Communication User's Manual (Cat. No. H124)

Ordering Information

■ Digital Controllers

Standard Controllers

Size	Control type	Control mode	Outputs (control/transfer)	Optional functions			Model	
				Auxiliary outputs (SUB)	Event inputs	Serial communi- cations		
96 × 96 mm	Basic control (1 loop)	Single-loop standard control Single-loop heating and cooling control	2 points: Pulse voltage and Pulse voltage/current	4	2	No	E5AR-Q4B	
			2 points: Current and Current				E5AR-C4B	
			2 points: Pulse voltage and Pulse voltage/current				RS-485	E5AR-Q43B-FLK (See note 2.)
			2 points: Current and Current					E5AR-C43B-FLK (See note 2.)
			2 points: Pulse voltage and Pulse voltage/current				6	E5AR-Q43DB-FLK (See note 2.)
			2 points: Current and Current					E5AR-C43DB-FLK (See note 2.)
			4 points: Pulse voltage and Pulse voltage/current and Current (2 points)					E5AR-QC43DB-FLK
2-loop control	2-loop standard control Single-loop heating and cooling control Single-loop cascade control Single-loop control with remote SP Single-loop proportional control	2 points: Pulse voltage and Pulse voltage/current	4	4	RS-485	E5AR-Q43DW-FLK (See note 2.)		
		2 points: Current and Current				E5AR-C43DW-FLK (See note 2.)		
		4 points: Pulse voltage (2 points) and Pulse voltage/current (2 points)				E5AR-QQ43DW-FLK		
4-loop control	4-loop standard control 2-loop heating and cooling control	4 points: Current output (4 points)	4	4	RS-485	E5AR-CC43DWW-FLK		
		4 points: Pulse voltage (2 points) and Pulse voltage/current (2 points)				E5AR-QQ43DWW-FLK (See note 2.)		
Position-proportional control (1 loop)	Single-loop position-proportional control (See note 3.)	Relay output (1 open, 1 close)	4	4	No	E5AR-PR4DF		
		Relay output (1 open, 1 close) and 1 current (transfer) output				RS-485	E5AR-PRQ43DF-FLK	

Note 1: Specify the power supply specifications when ordering. Model numbers for 100 to 240 VAC are different from those for 24 VAC/VDC.

2: These models are for 100 to 240 VAC only.

3: Can be switched between close control and floating control.

DeviceNet-compatible Controllers

Size	Control type	Control mode	Outputs (control/transfer)	Optional functions			Model
				Auxiliary outputs (SUB)	Event inputs	DeviceNet communi- cations	
96 × 96 mm	Basic control (1 loop)	1 loop for standard control Single-loop heating and cooling control	2 points: Pulse volt- age and Pulse volt- age/current	4	2	Yes	E5AR-Q4B-DRT
			2 points: Current and Current				E5AR-C4B-DRT
			4 points: Pulse volt- age and Pulse volt- age/current and Current (2 points)				E5AR-QC4B-DRT
	2-loop control	2-loop standard control 2-loop heating and cooling control Single-loop cascade control Single-loop control with remote SP Single-loop proportional control	4 points: Pulse volt- age (2 points) and Pulse voltage/cur- rent (2 points)	4	None	Yes	E5AR-QQ4W-DRT
	4-loop control	4-loop standard control 2-loop heating and cooling control	4 points: Current (4 points)	4	None	Yes	E5AR-CC4WW-DRT
	Position-pro- portional con- trol (1 loop)	Single-loop position-proportional con- trol (See note 2.)	Relay output (1 open, 1 close)	4	None	Yes	E5AR-PR4F-DRT
Relay output (1 open, 1 close) and 1 current (transfer) output			E5AR-PRQ4F-DRT				

Note: 1. Specify the power supply specifications when ordering. Model numbers for 100 to 240 VAC are different from those for 24 VAC/VDC.
2. Can be switched between close control and floating control.

Inspection Results

The Inspection Report can be ordered at the same time as the Digital Controller using the following model number.

Inspection Report (Sold Separately)

Descriptions	Model
Inspection Report for E5AR	E5AR-K

■ Accessories (Order Separately)

Terminal Cover (Sold Separately)

Descriptions	Model
Terminal Cover for E5AR	E53-COV14

Unit Label Sheet

Model
Y92S-L1

Rubber Packing

Model
Y92S-P4

Note: The Rubber Packing is provided with the Digital Controller.

■ Characteristics

Indication accuracy	Thermocouple input with cold junction compensation: ($\pm 0.1\%$ of PV or $\pm 1^\circ\text{C}$, whichever is greater) ± 1 digit max. (See note 1.) Thermocouple input without cold junction compensation: ($\pm 0.1\%$ FS or $\pm 1^\circ\text{C}$, whichever is smaller) ± 1 digit (See note 2.) Analog input: $\pm 0.1\%$ FS ± 1 digit max. Platinum resistance thermometer input: ($\pm 0.1\%$ of PV or $\pm 0.5^\circ\text{C}$, whichever is greater) ± 1 digit max. Position-proportional potentiometer input: $\pm 5\%$ FS ± 1 digit max.
Control mode	Standard control (heating or cooling control), heating/cooling control, standard control with remote SP (2-input models only), heating/cooling control with remote SP (2-input models only), cascade standard control (2-input models only), cascade heating/cooling control (2-input models only), proportional control (2-input models only), position-proportional control (control-valve control models only)
Influence of temperature	Thermocouple input (R, S, B, W): ($\pm 1\%$ of PV or $\pm 10^\circ\text{C}$, whichever is greater) ± 1 digit max. Other thermocouple input: ($\pm 1\%$ of PV or $\pm 4^\circ\text{C}$, whichever is greater) ± 1 digit max. *K-type thermocouple at -100°C max.: $\pm 10^\circ\text{C}$ max.
Influence of voltage	Platinum resistance thermometer: ($\pm 1\%$ of PV or $\pm 2^\circ\text{C}$, whichever is greater) ± 1 digit max. Analog input: ($\pm 1\%$ FS) ± 1 digit max.
Control period	0.2 to 99.0 s (in units of 0.1 s) for time-proportioning control output
Proportional band (P)	0.00% to 999.99% FS (in units of 0.01% FS)
Integral time (I)	0.0 to 3,999.9 s (in units of 0.1 s)
Derivative time (D)	0.0 to 3,999.9 s (in units of 0.1 s)
Hysteresis	0.01% to 99.99% FS (in units of 0.01% FS)
Manual reset value	0.0% to 100.0% (in units of 0.1% FS)
Alarm setting range	-19,999 to 99,999 EU (See note 3.) (The decimal point position depends on the input type and the decimal point position setting.)
Input sampling period	50 ms
Insulation resistance	20 M Ω min. (at 500 VDC)
Dielectric strength	2,000 VAC, 50/60 Hz for 1 min (between charged terminals of different polarities)
Vibration resistance	10 to 55 Hz, 20 m/s ² for 10 min each in X, Y, and Z directions
Shock resistance	100 m/s ² , 3 times each in X, Y, and Z directions
Inrush current	100 to 240-VAC models: 50 A max. 24 VAC/VDC models: 30 A max.
Weight	Controller only: Approx. 450 g; Mounting bracket: Approx. 60 g; Terminal cover: Approx. 30 g
Degree of protection	Front panel: NEMA4X for indoor use (equivalent to IP66); Rear case: IP20; Terminals: IP00
Memory protection	Non-volatile memory (number of writes: 100,000)
Applicable standards	UL61010C-1, CSA C22.2 No. 1010-1 EN61010-1 (IEC61010-1): Pollution degree 2/overvoltage category 2
EMC	EMI: EN61326 Radiated Interference Electromagnetic Field Strength: EN55011 Group 1 Class A Noise Terminal Voltage: EN55011 Group 1 Class A EMS: EN61326 ESD Immunity: EN61000-4-2: 4 kV contact discharge (level 2) 8 kV air discharge (level 3) Electromagnetic Immunity: EN61000-4-3: 10 V/m (amplitude-modulated, 80 MHz to 1 GHz, 1.4 GHz to 2 GHz) (level 3) Burst Noise Immunity: EN61000-4-4: 2 kV power line (level 3) 2 kV output line (relay output) (level 4) 1 kV measurement line, I/O signal line (level 4) 1 kV communications line (level 3) Conducted Disturbance Immunity: EN61000-4-6: 3 V (0.15 to 80 MHz) (level 3) Surge Immunity: EN61000-4-5: 1 kV line to line (power line, output line (relay output)) (level 2) 2 kV line to ground (power line, output line (relay output)) (level 3) Power Frequency Magnetic Field Immunity: EN61000-4-8: 30 A/m (50 Hz) continuous field Voltage Dip/Interrupting Immunity: EN61000-4-11: 0.5 cycle, 100% (rated voltage)

Note 1: K-, T-, or N-type thermocouple at -100°C max.: $\pm 2^\circ\text{C}$ ± 1 digit max.
U- or L-type thermocouple: $\pm 2^\circ\text{C}$ ± 1 digit max.
B-type thermocouple at 400°C max.: No accuracy specification.
R- or S-type thermocouple at 200°C max.: $\pm 3^\circ\text{C}$ ± 1 digit max.
W-type thermocouple: ($\pm 0.3\%$ of PV or $\pm 3^\circ\text{C}$, whichever is greater) ± 1 digit max.

2: U- or L-type thermocouple: $\pm 1^\circ\text{C}$ ± 1 digit

R- or S-type thermocouple at 200°C max.: $\pm 1.5^\circ\text{C}$ ± 1 digit

3: "EU" (Engineering Unit) represents the unit after scaling. If a temperature sensor is used it is either $^\circ\text{C}$ or $^\circ\text{F}$.

4: Conditions: Ambient temperature from -10 to 23 to 55°C and voltage of -15% to 10% of rated voltage.

■ Communications Specifications

Transmission path connection	Multiple points
Communications method	RS-485 (two-wire, half duplex)
Synchronization method	Start-stop synchronization
Baud rate	9,600, 19,200, or 384,000 bps
Transmission code	ASCII
Data bit length	7 or 8 bits
Stop bit length	1 or 2 bits
Error detection	Vertical parity (none, even, odd) Block check character (BCC): CompoWay/F CRC-16: Modbus
Flow control	None
Interface	RS-485
Retry function	None
Communications buffer	217 bytes
Communications response send wait time	0 to 99 ms, Default: 20 ms

DeviceNet

Item		Specifications			
Communications protocol		Conforms to DeviceNet			
Communications functions	Remote I/O communications	<ul style="list-style-type: none"> Master-slave connections (polling, bit-strobe, COS, or cyclic) Conform to DeviceNet specifications. 			
	I/O allocations	<ul style="list-style-type: none"> Can allocate any I/O data from the Configurator. Can allocate any data, such as parameters specific to the DeviceNet and the Digital Controller variable area. Up to 2 blocks for the IN Area, up to a total of 100 words. One block for the OUT Area, up to 100 words (first word is always allocated to Output Enable Bits). 			
	Message communications	<ul style="list-style-type: none"> Explicit message communications CompoWay/F communications commands can be sent (commands are sent in explicit message format). 			
Connection format		Combination of multidrop and T-branch connections (for trunk and drop lines)			
Baud rate		DeviceNet: 500, 250, or 125 kbps, or automatic detection of master baud rate			
Communications media		Special 5-wire cable (2 signal lines, 2 power lines, and 1 shield line)			
Communications distance		Baud rate	Network length	Drop line length	Total drop line length
		500 kbps	100 m max. (100 m max.)	6 m max.	39 m max.
		250 kbps	250 m max. (100 m max.)	6 m max.	78 m max.
		125 kbps	500 m max. (100 m max.)	6 m max.	156 m max.
The values in parentheses apply when Thin Cables are used.					
Supply voltage		DeviceNet power supply: 24 VDC			
Allowable voltage range		DeviceNet power supply: 11 to 25 VDC			
Current consumption		50 mA max. (24 VDC)			
Maximum number of nodes that can be connected		64 (includes Configurator when used)			
Maximum number of slaves that can be connected		63			
Error control		CRC error detection			
Power supply		Power supplied from DeviceNet communications connector.			

Wiring Terminals

E5AR Standard Controller Connections

E5AR-Q4B

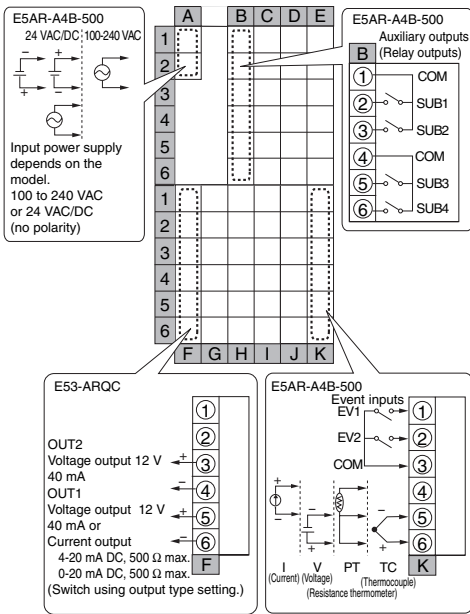

E5AR-C4B

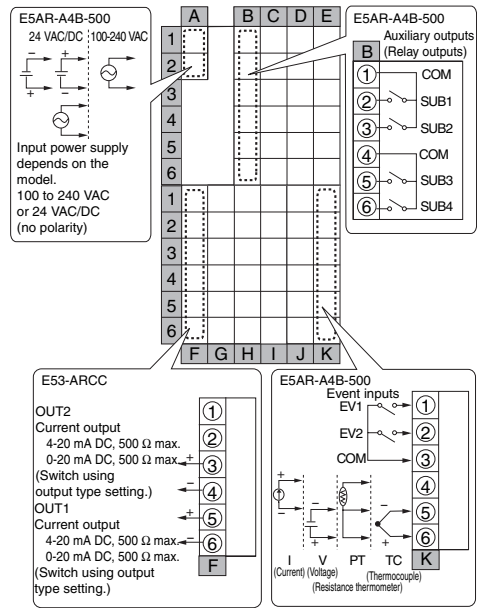

E5AR-Q43B-FLK

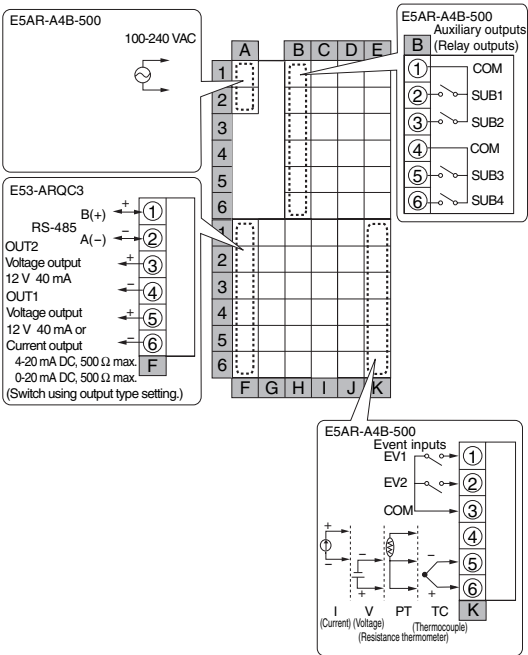

E5AR-C43B-FLK

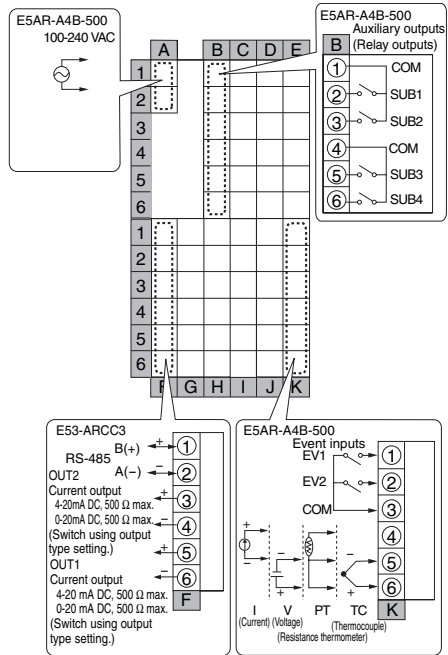

E5AR-Q43DW-FLK (2-loop Control)



E5AR-C43DW-FLK (2-loop Control)



E5AR-QQ43DW-FLK (2-loop Control)

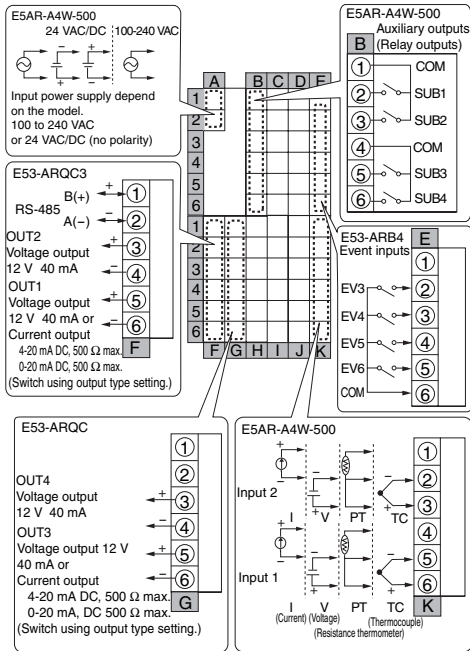

E5AR-CC43DWW-FLK (4-loop Control)



E5AR-QQ43DWW-FLK (4-loop Control)

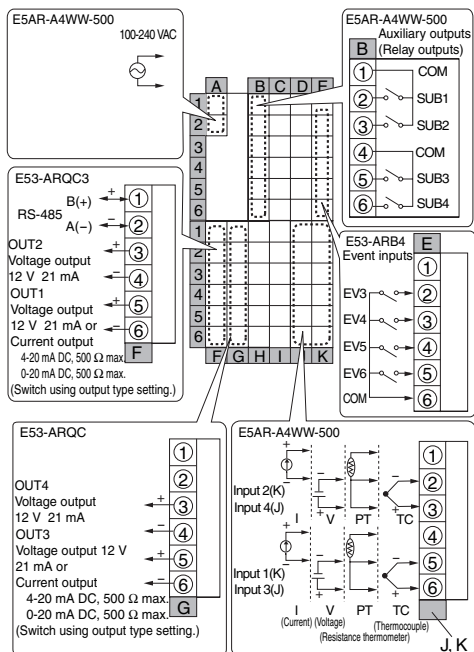

E5AR-PR4DF

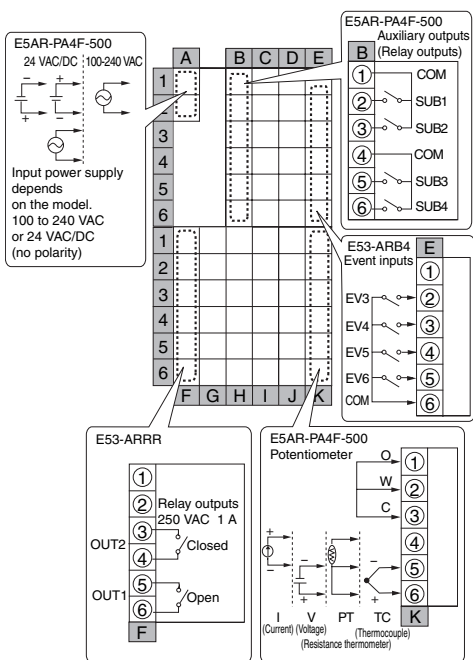

E5AR-PRQ43DF-FLK

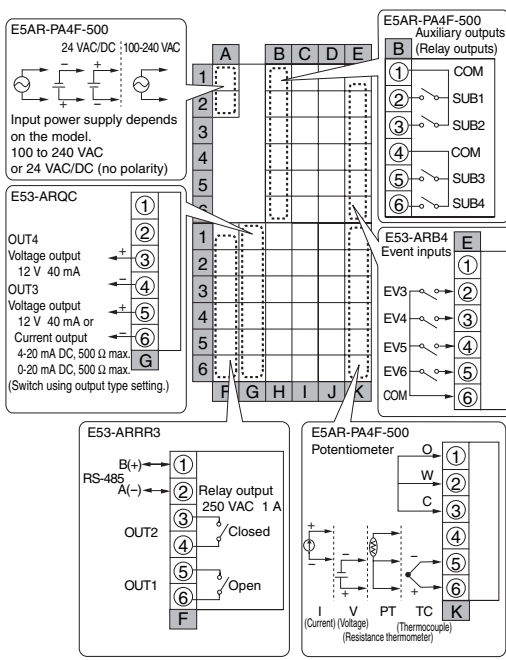

E5AR DeviceNet-compatible Controller Connections

E5AR-Q4B-DRT

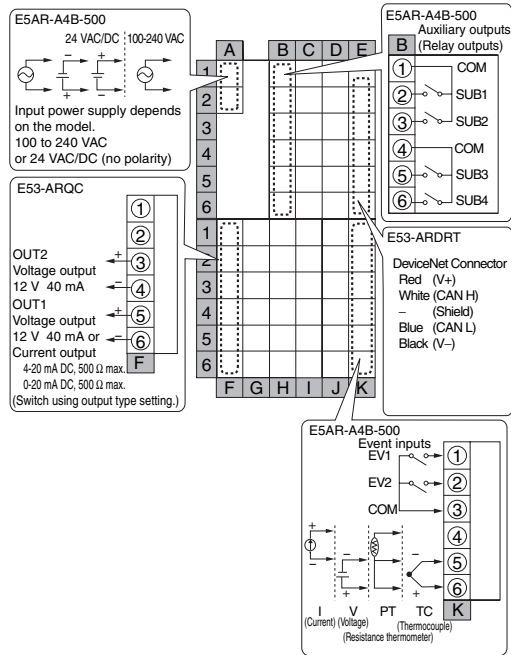

E5AR-C4B-DRT

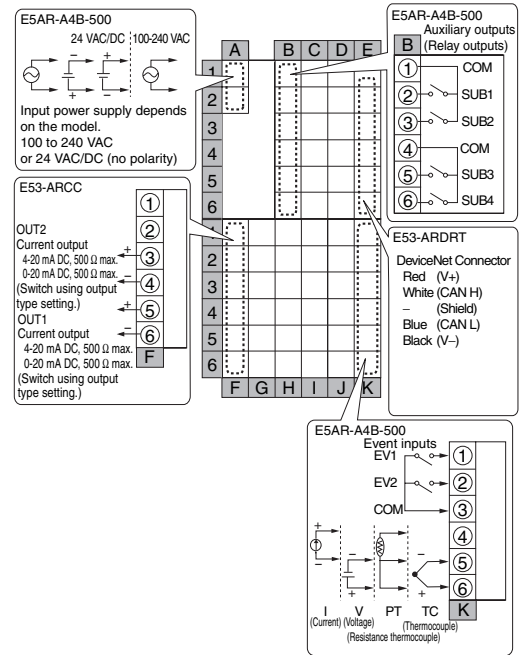

E5AR-QC4B-DRT

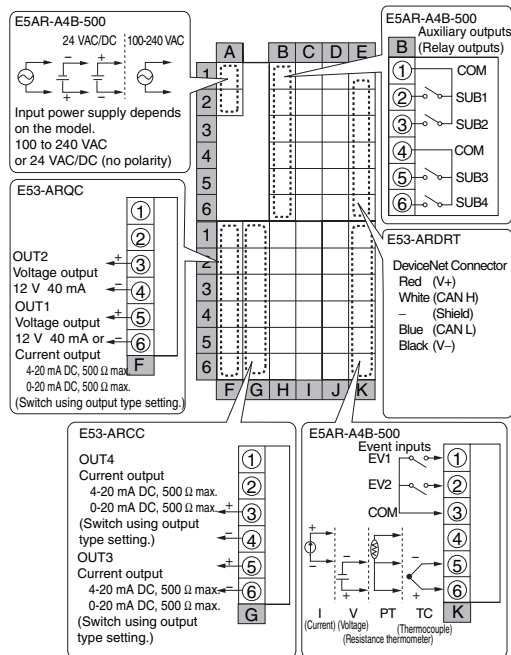

E5AR-QQ4W-DRT (2-loop Control)

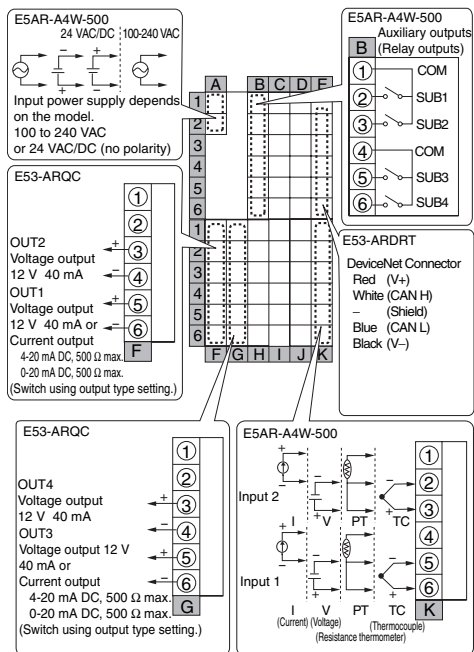

E5AR-CC4WW-DRT (4-loop Control)

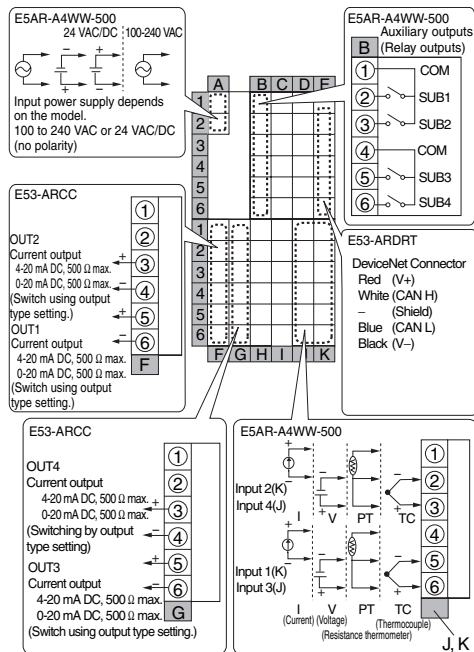

E5AR-PR4F-DRT

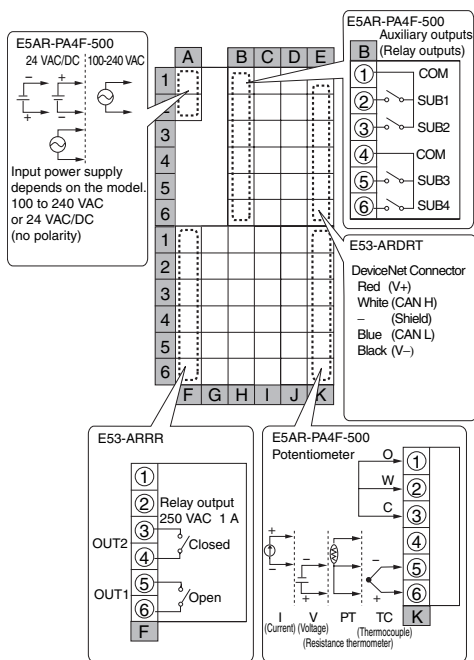

E5AR-PRQ4F-DRT

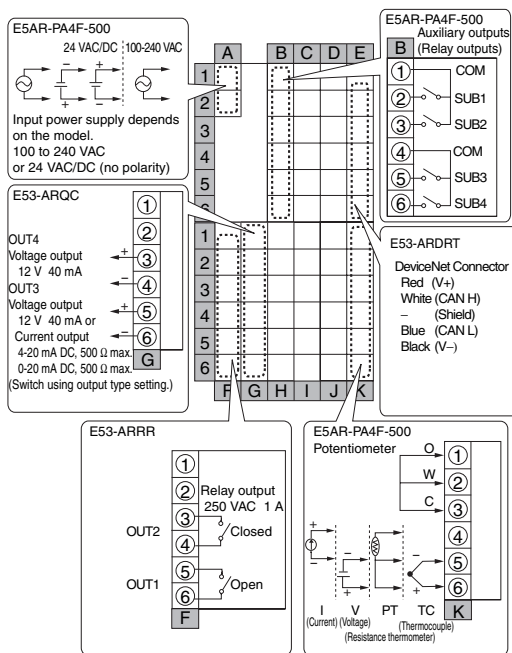

Nomenclature

E5AR

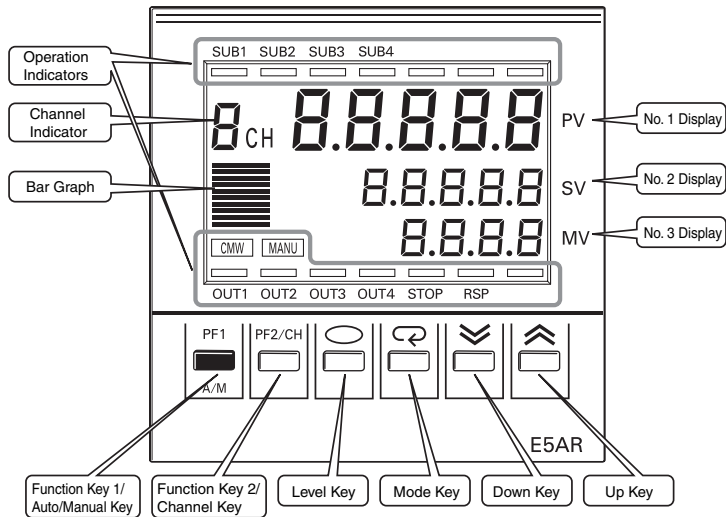

DeviceNet-compatible Controllers, Rear Panel

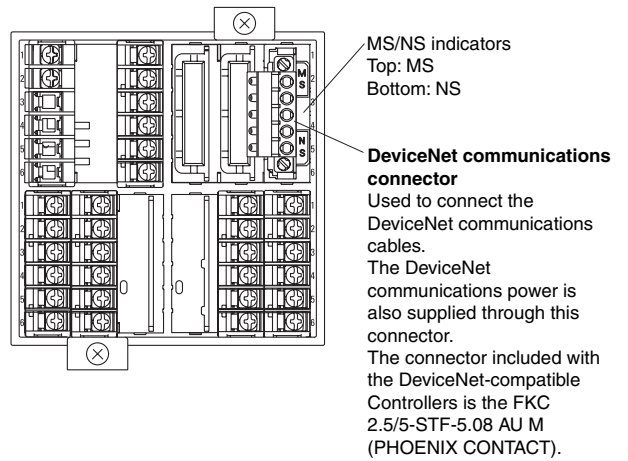

Dimensions

Note: All units are in millimeters unless otherwise indicated.

E5AR

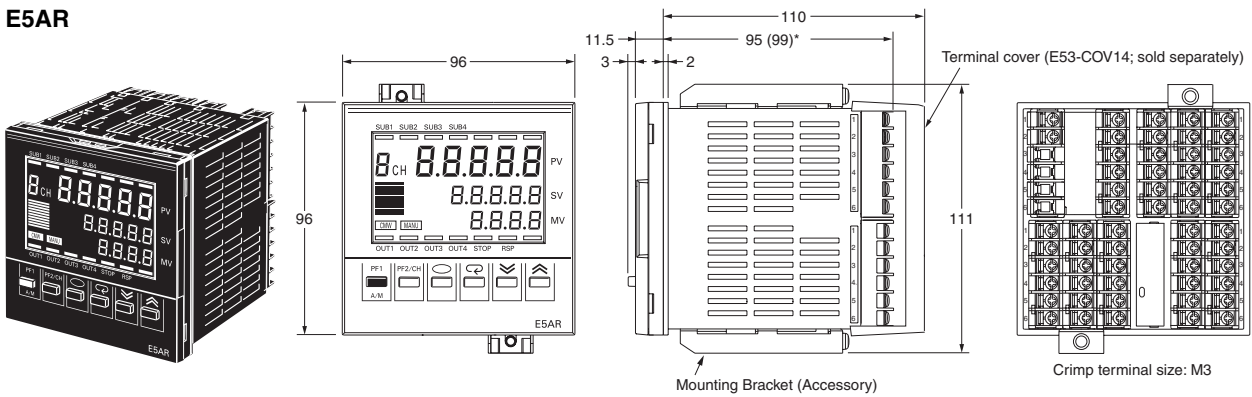

Panel Cutouts

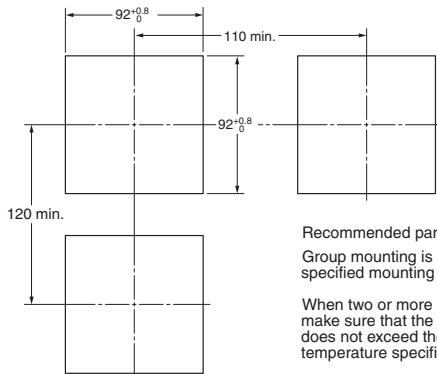

Recommended panel thickness is 1 to 8 mm.
Group mounting is not possible. (Maintain the specified mounting space between Controllers.)

When two or more Controllers are mounted, make sure that the surrounding temperature does not exceed the allowable operating temperature specified in the specifications.

* The value in parentheses is for DeviceNet-compatible Controllers.

■ Accessories (Order Separately)

Terminal Cover

E53-COV14 (for E5AR)

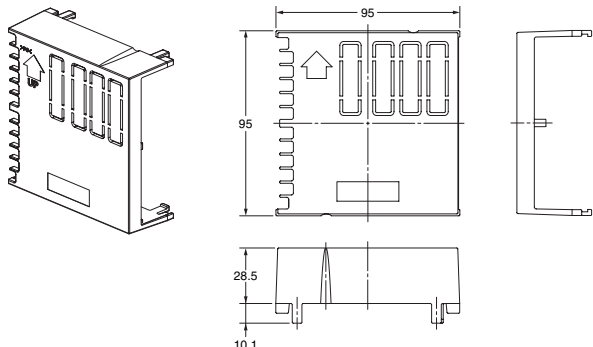

Unit Label Sheet

Y92S-L1

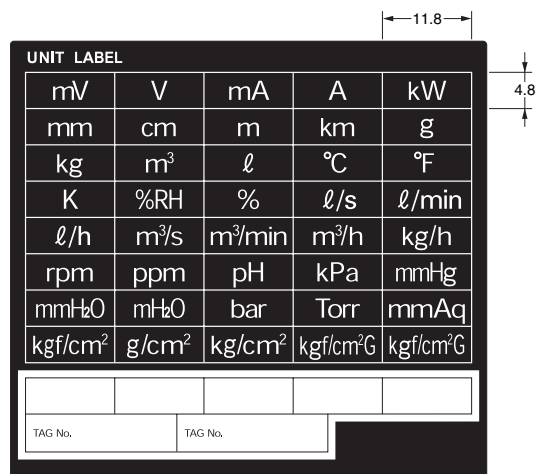

Rubber Packing

Y92S-P4 (for DIN96 × 96)



Order the Rubber Packing separately if it becomes lost or damaged. (Refer to page 3.)

The Rubber Packing can be used to achieve an IP66 degree of protection.

(Deterioration, shrinking, or hardening of the rubber packing may occur depending on the operating environment.

Therefore, periodic replacement is recommended to ensure the level of waterproofing specified in NEMA4. The time for periodic replacement depends on the operating environment. Be sure to confirm this point at your site. Consider one year a rough standard. OMRON shall not be liable for the level of water resistance if the customer does not perform periodic replacement.)

The Rubber Packing does not need to be attached if a waterproof structure is not required.

ALL DIMENSIONS SHOWN ARE IN MILLIMETERS.
To convert millimeters into inches, multiply by 0.03937. To convert grams into ounces, multiply by 0.03527.

In the interest of product improvement, specifications are subject to change without notice.

Read and Understand This Catalog

Please read and understand this catalog before purchasing the products. Please consult your OMRON representative if you have any questions or comments.

Warranty and Limitations of Liability

WARRANTY

OMRON's exclusive warranty is that the products are free from defects in materials and workmanship for a period of one year (or other period if specified) from date of sale by OMRON.

OMRON MAKES NO WARRANTY OR REPRESENTATION, EXPRESS OR IMPLIED, REGARDING NON-INFRINGEMENT, MERCHANTABILITY, OR FITNESS FOR PARTICULAR PURPOSE OF THE PRODUCTS. ANY BUYER OR USER ACKNOWLEDGES THAT THE BUYER OR USER ALONE HAS DETERMINED THAT THE PRODUCTS WILL SUITABLY MEET THE REQUIREMENTS OF THEIR INTENDED USE. OMRON DISCLAIMS ALL OTHER WARRANTIES, EXPRESS OR IMPLIED.

LIMITATIONS OF LIABILITY

OMRON SHALL NOT BE RESPONSIBLE FOR SPECIAL, INDIRECT, OR CONSEQUENTIAL DAMAGES, LOSS OF PROFITS OR COMMERCIAL LOSS IN ANY WAY CONNECTED WITH THE PRODUCTS, WHETHER SUCH CLAIM IS BASED ON CONTRACT, WARRANTY, NEGLIGENCE, OR STRICT LIABILITY.

In no event shall the responsibility of OMRON for any act exceed the individual price of the product on which liability is asserted.

IN NO EVENT SHALL OMRON BE RESPONSIBLE FOR WARRANTY, REPAIR, OR OTHER CLAIMS REGARDING THE PRODUCTS UNLESS OMRON'S ANALYSIS CONFIRMS THAT THE PRODUCTS WERE PROPERLY HANDLED, STORED, INSTALLED, AND MAINTAINED AND NOT SUBJECT TO CONTAMINATION, ABUSE, MISUSE, OR INAPPROPRIATE MODIFICATION OR REPAIR.

Application Considerations

SUITABILITY FOR USE

OMRON shall not be responsible for conformity with any standards, codes, or regulations that apply to the combination of products in the customer's application or use of the products.

At the customer's request, OMRON will provide applicable third party certification documents identifying ratings and limitations of use that apply to the products. This information by itself is not sufficient for a complete determination of the suitability of the products in combination with the end product, machine, system, or other application or use.

The following are some examples of applications for which particular attention must be given. This is not intended to be an exhaustive list of all possible uses of the products, nor is it intended to imply that the uses listed may be suitable for the products:

- Outdoor use, uses involving potential chemical contamination or electrical interference, or conditions or uses not described in this catalog.
- Nuclear energy control systems, combustion systems, railroad systems, aviation systems, medical equipment, amusement machines, vehicles, safety equipment, and installations subject to separate industry or government regulations.
- Systems, machines, and equipment that could present a risk to life or property.

Please know and observe all prohibitions of use applicable to the products.

NEVER USE THE PRODUCTS FOR AN APPLICATION INVOLVING SERIOUS RISK TO LIFE OR PROPERTY WITHOUT ENSURING THAT THE SYSTEM AS A WHOLE HAS BEEN DESIGNED TO ADDRESS THE RISKS, AND THAT THE OMRON PRODUCTS ARE PROPERLY RATED AND INSTALLED FOR THE INTENDED USE WITHIN THE OVERALL EQUIPMENT OR SYSTEM.

PROGRAMMABLE PRODUCTS

OMRON shall not be responsible for the user's programming of a programmable product, or any consequence thereof.

Disclaimers

CHANGE IN SPECIFICATIONS

Product specifications and accessories may be changed at any time based on improvements and other reasons.

It is our practice to change model numbers when published ratings or features are changed, or when significant construction changes are made. However, some specifications of the products may be changed without any notice. When in doubt, special model numbers may be assigned to fix or establish key specifications for your application on your request. Please consult with your OMRON representative at any time to confirm actual specifications of purchased products.

DIMENSIONS AND WEIGHTS

Dimensions and weights are nominal and are not to be used for manufacturing purposes, even when tolerances are shown.

PERFORMANCE DATA

Performance data given in this catalog is provided as a guide for the user in determining suitability and does not constitute a warranty. It may represent the result of OMRON's test conditions, and the users must correlate it to actual application requirements. Actual performance is subject to the OMRON Warranty and Limitations of Liability.

ERRORS AND OMISSIONS

The information in this document has been carefully checked and is believed to be accurate; however, no responsibility is assumed for clerical, typographical, or proofreading errors, or omissions.

2010.12

In the interest of product improvement, specifications are subject to change without notice.

OMRON Corporation
Industrial Automation Company

<http://www.ia.omron.com/>

(c)Copyright OMRON Corporation 2010 All Right Reserved.

Компания «Океан Электроники» предлагает заключение долгосрочных отношений при поставках импортных электронных компонентов на взаимовыгодных условиях!

Наши преимущества:

- Поставка оригинальных импортных электронных компонентов напрямую с производств Америки, Европы и Азии, а так же с крупнейших складов мира;
- Широкая линейка поставок активных и пассивных импортных электронных компонентов (более 30 млн. наименований);
- Поставка сложных, дефицитных, либо снятых с производства позиций;
- Оперативные сроки поставки под заказ (от 5 рабочих дней);
- Экспресс доставка в любую точку России;
- Помощь Конструкторского Отдела и консультации квалифицированных инженеров;
- Техническая поддержка проекта, помощь в подборе аналогов, поставка прототипов;
- Поставка электронных компонентов под контролем ВП;
- Система менеджмента качества сертифицирована по Международному стандарту ISO 9001;
- При необходимости вся продукция военного и аэрокосмического назначения проходит испытания и сертификацию в лаборатории (по согласованию с заказчиком);
- Поставка специализированных компонентов военного и аэрокосмического уровня качества (Xilinx, Altera, Analog Devices, Intersil, Interpoint, Microsemi, Actel, Aeroflex, Peregrine, VPT, Syfer, Eurofarad, Texas Instruments, MS Kennedy, Miteq, Cobham, E2V, MA-COM, Hittite, Mini-Circuits, General Dynamics и др.);

Компания «Океан Электроники» является официальным дистрибьютором и эксклюзивным представителем в России одного из крупнейших производителей разъемов военного и аэрокосмического назначения «JONHON», а так же официальным дистрибьютором и эксклюзивным представителем в России производителя высокотехнологичных и надежных решений для передачи СВЧ сигналов «FORSTAR».



JONHON

«JONHON» (основан в 1970 г.)

Разъемы специального, военного и аэрокосмического назначения:

(Применяются в военной, авиационной, аэрокосмической, морской, железнодорожной, горно- и нефтедобывающей отраслях промышленности)

«FORSTAR» (основан в 1998 г.)

ВЧ соединители, коаксиальные кабели, кабельные сборки и микроволновые компоненты:

(Применяются в телекоммуникациях гражданского и специального назначения, в средствах связи, РЛС, а так же военной, авиационной и аэрокосмической отраслях промышленности).



Телефон: 8 (812) 309-75-97 (многоканальный)

Факс: 8 (812) 320-03-32

Электронная почта: ocean@oceanchips.ru

Web: <http://oceanchips.ru/>

Адрес: 198099, г. Санкт-Петербург, ул. Калинина, д. 2, корп. 4, лит. А