



Features

- Tx Output Power: 30dBm
- Separate 50Ω Tx/Rx Transceiver Interface
- Optional 100Ω Rx Differential Transceiver Interface
- Rx Insertion Loss: 1dB

Applications

- Wireless Automated Metering
- Wireless Alarm Systems
- Portable Battery Powered Equipment
- Smart Energy
- 868MHz/900MHz ISM Band Application
- Single Chip RF Front End Module

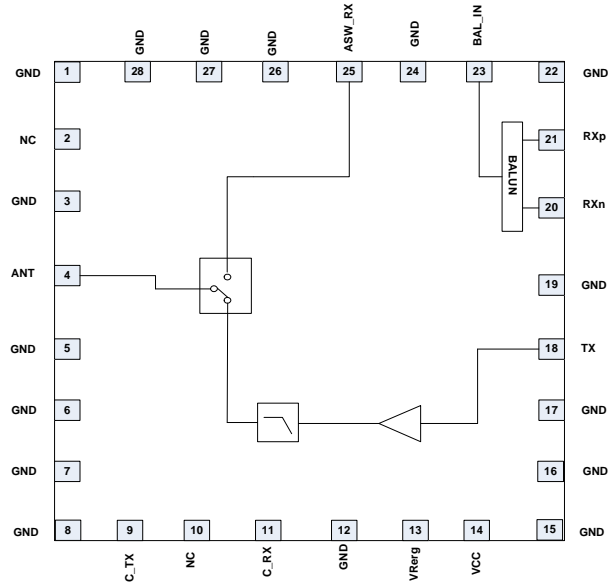

Functional Block Diagram

Product Description

This module is intended for 868MHz and 915MHz AMR solutions. The FEM provides separate ports for Rx/Tx paths, single-ended Tx and single-ended Rx or Rx differential port, and single port antenna connection. The PA section provides a nominal output power of 30dBm. The device is provided in a 5.5mm x 5.0mm, 28-pin package.

Ordering Information

RF6569SB	Standard 5-piece bag
RF6569SQ	Standard 25-piece bag
RF6569SR	Standard 100-piece reel
RF6569TR7	Standard 750-piece reel
RF6569TR13	Standard 2500-piece reel
RF6569PCK-410	Fully Assembled Evaluation Board and 5-piece bag

Optimum Technology Matching® Applied

- | | | | |
|---|--------------------------------------|--|------------------------------------|
| <input type="checkbox"/> GaAs HBT | <input type="checkbox"/> SiGe BiCMOS | <input checked="" type="checkbox"/> GaAs pHEMT | <input type="checkbox"/> GaN HEMT |
| <input type="checkbox"/> GaAs MESFET | <input type="checkbox"/> Si BiCMOS | <input type="checkbox"/> Si CMOS | <input type="checkbox"/> BiFET HBT |
| <input checked="" type="checkbox"/> InGaP HBT | <input type="checkbox"/> SiGe HBT | <input type="checkbox"/> Si BJT | <input type="checkbox"/> SOI |

RF MICRO DEVICES®, RFMD®, Optimum Technology Matching®, Enabling Wireless Connectivity™, PowerStar®, POLARIS™ TOTAL RADIO™ and UltimateBlue™ are trademarks of RFMD, LLC. BLUETOOTH is a trademark owned by Bluetooth SIG, Inc., U.S.A. and licensed for use by RFMD. All other trade names, trademarks and registered trademarks are the property of their respective owners. ©2012, RF Micro Devices, Inc.

Absolute Maximum Ratings

Parameter	Rating	Unit
Battery Voltage	5	V
RF Port Impedance	50	Ω
Operating Temperature	-40 to 85	$^{\circ}\text{C}$
Storage Temperature	-40 to 85	$^{\circ}\text{C}$
ESD, HBM (RF pins)	500	V
ESD, HBM (All pins)	500	V
ESD, CDN (RF pins)	500	V
ESD, CDM (all pins)	500	V
MSL	MSL 3	
Maximum Input Power to PA	+20	dBm



Caution! ESD sensitive device.

Exceeding any one or a combination of the Absolute Maximum Rating conditions may cause permanent damage to the device. Extended application of Absolute Maximum Rating conditions to the device may reduce device reliability. Specified typical performance or functional operation of the device under Absolute Maximum Rating conditions is not implied.

The information in this publication is believed to be accurate and reliable. However, no responsibility is assumed by RF Micro Devices, Inc. ("RFMD") for its use, nor for any infringement of patents, or other rights of third parties, resulting from its use. No license is granted by implication or otherwise under any patent or patent rights of RFMD. RFMD reserves the right to change component circuitry, recommended application circuitry and specifications at any time without prior notice.



RFMD Green: RoHS compliant per EU Directive 2002/95/EC, halogen free per IEC 61249-2-21, < 1000ppm each of antimony trioxide in polymeric materials and red phosphorus as a flame retardant, and <2% antimony in solder.

Parameter	Specification			Unit	Condition
	Min.	Typ.	Max.		
Frequency	868	902 to 928		MHz	
RF Port Impedance		50		Ω	
Total Leakage Current		1		μA	$V_{\text{CC}} = 3.6\text{V}, V_{\text{REG}} = 0\text{V}$
ESD, HBM	500			V	RF pins
	500			V	All other pins
ESD, CDM	500			V	RF pins
	500			V	All other pins
PA Section					$V_{\text{CC}} = 3.6\text{V}, V_{\text{REG}} = 3.4\text{V}, C_{\text{TX}} = 3.4\text{V}, C_{\text{RX}} = 0\text{V}, \text{Temperature} = 25^{\circ}\text{C}; P_{\text{OUT}} = 30\text{dBm}$. Unless otherwise specified.
CW P_{OUT} Saturation	30	31	32	dBm	
Large Signal Gain	12	15		dB	
Thermal Resistance	23			$^{\circ}\text{C}/\text{W}$	$V_{\text{CC}} = 3.6\text{V}, V_{\text{REG}} = 3.4\text{V}, C_{\text{TX}} = 3.4\text{V}, C_{\text{RX}} = 0\text{V}, T_{\text{REF}} = 85^{\circ}\text{C}, P_{\text{OUT}} = 30\text{dBm}$
2Fo	-40	-35		dBc	
3Fo to 10Fo		-75	-72	dBc	
Input Return Loss		18		dB	
Battery Voltage	3.3	3.6	4.0	V	V_{CC}
Battery Current	550	680	850	mA	
Quiescent Current		200		mA	No RF
Power Down Current		0.3	2	μA	$V_{\text{CC}} = 3.6, V_{\text{REG}} = 0\text{V}$
V_{REG}	3.1	3.4	3.8	V	V_{CC} to 0.2V
V_{REG} Current		3	4	mA	
RX Section					$V_{\text{CC}} = 3.6\text{V}, V_{\text{REG}} = 0\text{V}, C_{\text{TX}} = 0\text{V}, C_{\text{RX}} = 3.4\text{V}, \text{Temperature} = 25^{\circ}\text{C}$; Unless otherwise specified.
Noise Figure		0.7	1	dB	
Input IP3	12	18		dBm	
Input Return Loss	10			dB	
Output Return Loss	10			dB	

Parameter	Specification			Unit	Condition
	Min.	Typ.	Max.		
Antenna Switch Section					
Isolation	20			dB	Any used port to any unused port
Logic Voltage, High	3.1	3.4	3.8	V	All Logic I/Os, V _{BAT} to 0.2V
Logic Voltage, Low	0.0	0.2	0.4	V	All Logic I/Os
Logic Current, High		5	15	μA	All Logic I/Os
Logic Current, Low		0.4		μA	All Logic I/Os

Operating Mode	Module Logic Truth Table	
	C_TX	C_RX
TX-ANT	1	0
RX-ANT	0	1

NOTES:

*Switch Control Logic High = Min 3.1V to Max 3.8V

*Switch Control Logic Low = Min 0.0V to Max 0.4V

Pin Names and Descriptions

Pin	Name	Description
1	GND	Ground
2	NC	
3	GND	Ground
4	ANT	Antenna Connect Port
5	GND	Ground
6	GND	Ground
7	GND	Ground
8	GND	Ground
9	C_TX	Transmit Selection Control Line
10	NC	
11	C_RX	Receive Selection Control Line
12	GND	Ground
13	VREG	Power Amplifier Bias Control. V_{CC} to 0.2V = ON, 0V = OFF
14	VCC	Power Amplifier Supply Voltage
15	GND	Ground
16	GND	Ground
17	GND	Ground
18	TX	Transmit Port
19	GND	Ground
20	RFn	Receive Port neg
21	RXp	Receive Port pos
22	GND	Ground
23	BAL_IN	Input to Balun
24	GND	Ground
25	ASW_RX	Antenna Switched Rx Output
26	GND	Ground
27	GND	Ground
28	GND	Ground

Package Drawing

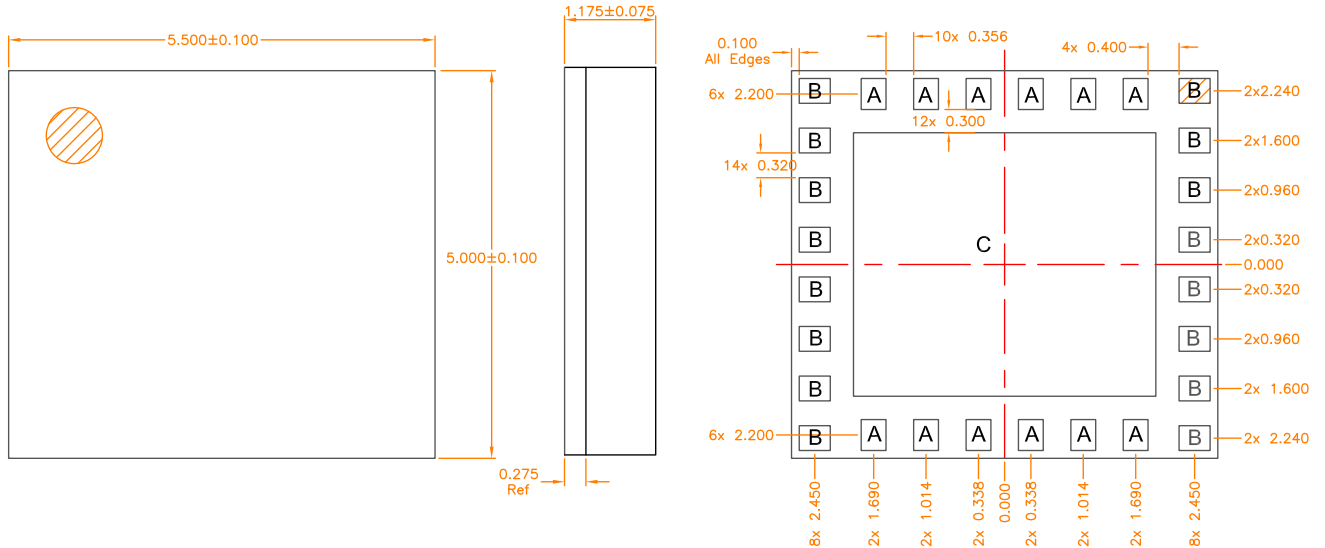

Notes:

1. Shaded area represents Pin 1 location.

A = 0.320 x 0.400 mm
 B = 0.400 x 0.320 mm
 C = 3.900 x 3.400 mm

All units in μm .

PCB Design Requirements

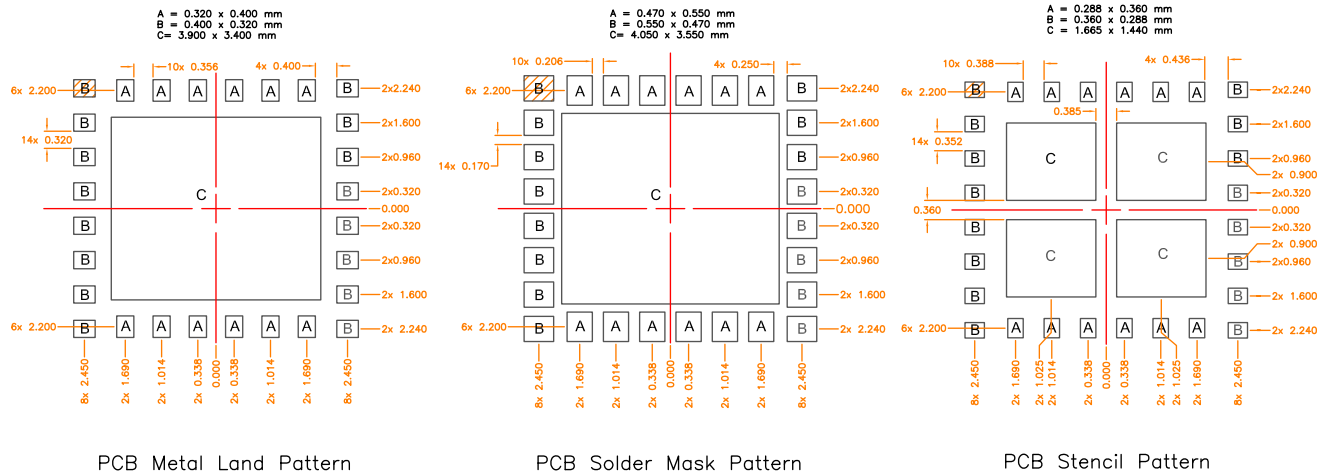

PCB Metal Land Pattern

PCB Solder Mask Pattern

PCB Stencil Pattern

Notes:

1. Shaded area represents Pin 1 location.

Application Schematic

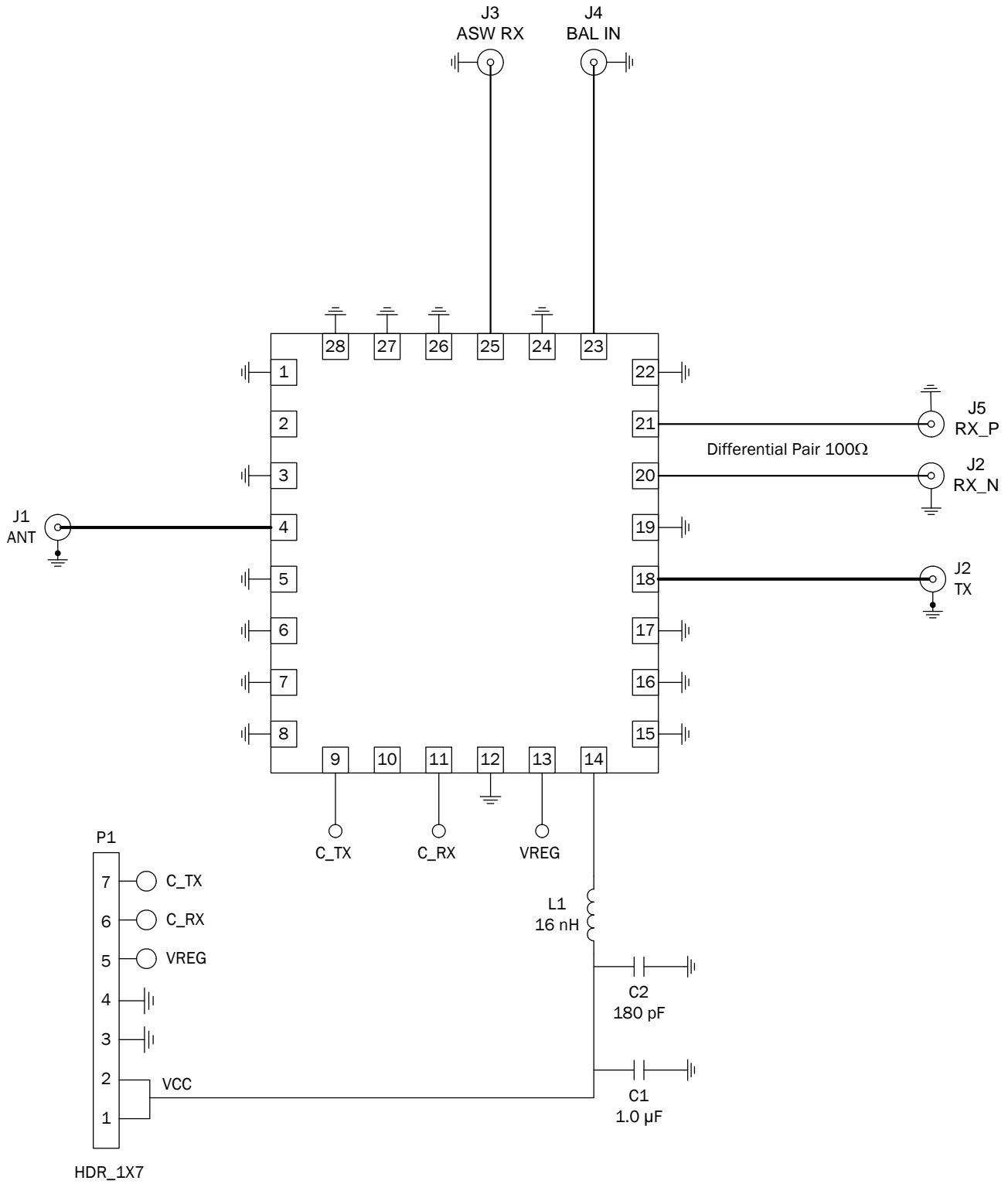

Typical Performance

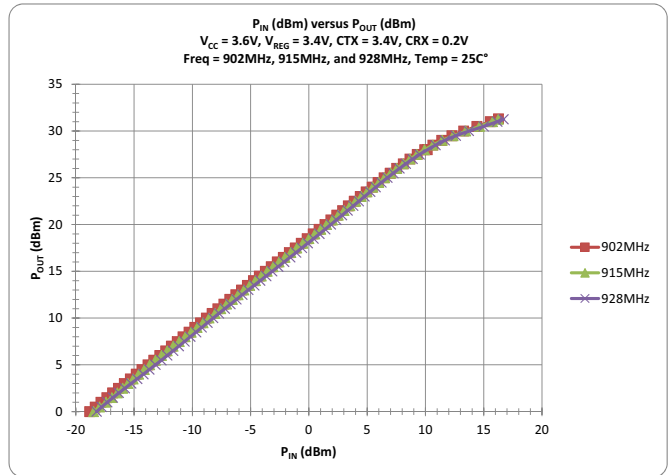
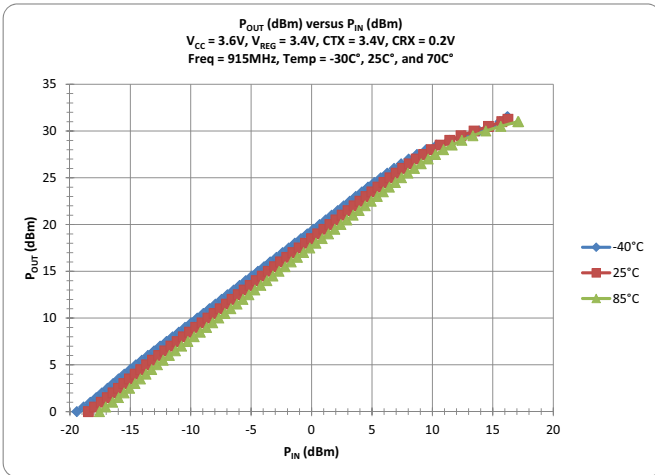
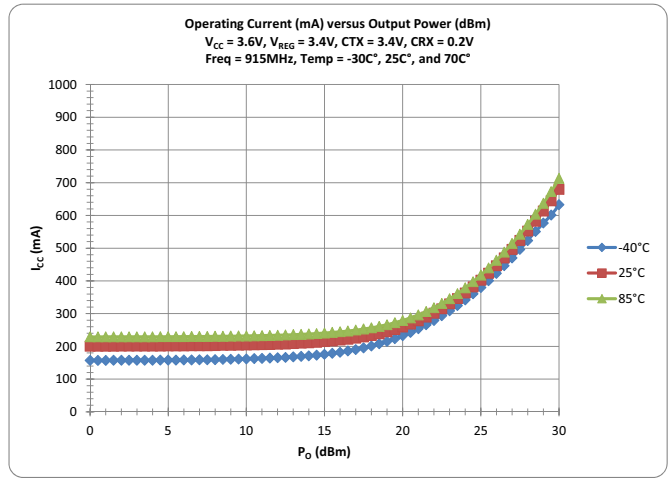
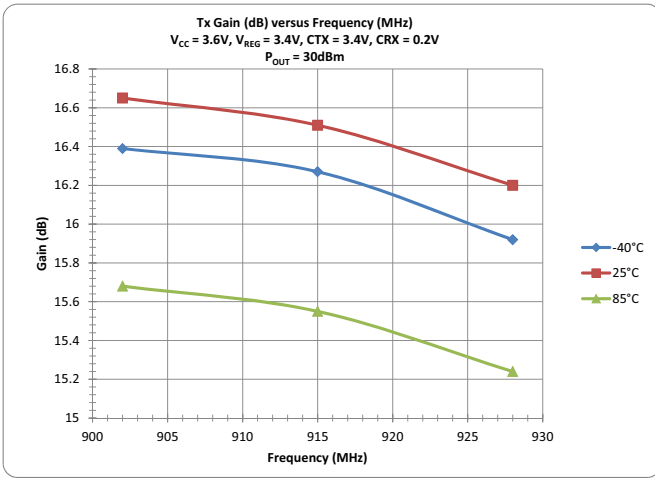
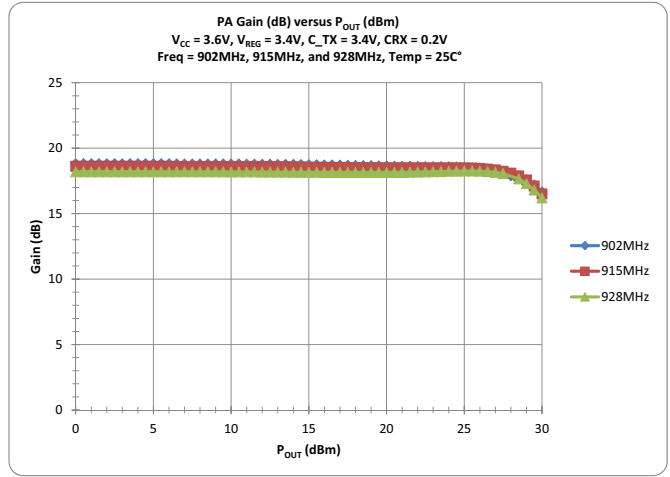
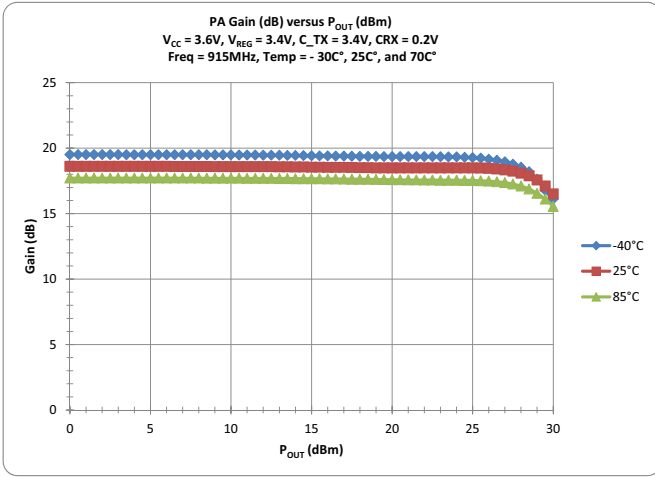

Typical Performance

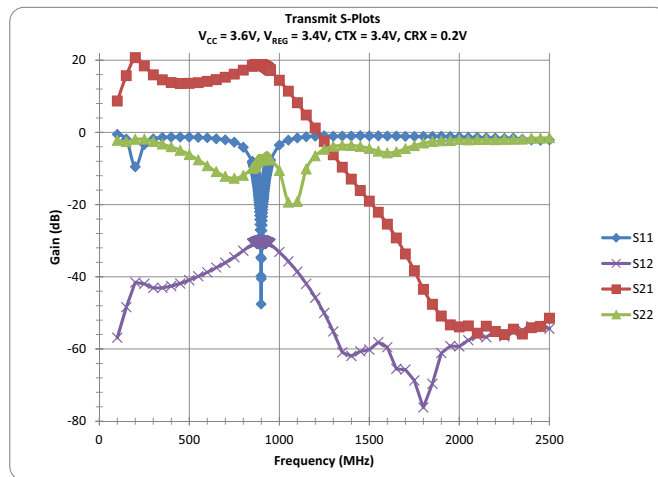
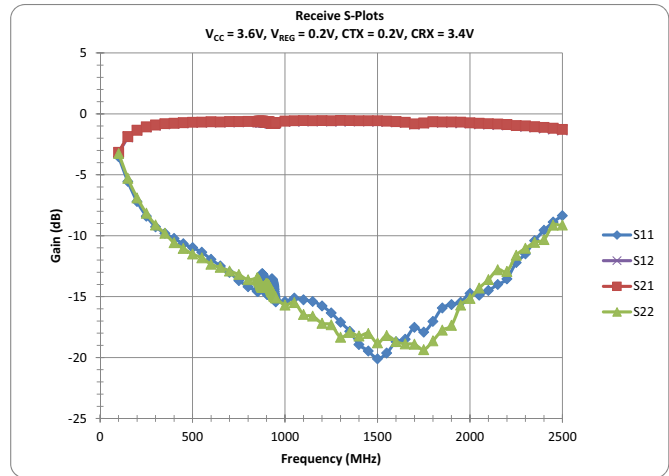
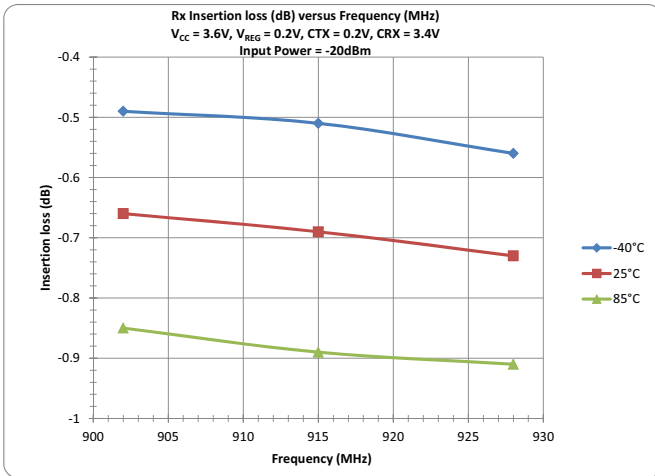

Компания «Океан Электроники» предлагает заключение долгосрочных отношений при поставках импортных электронных компонентов на взаимовыгодных условиях!

Наши преимущества:

- Поставка оригинальных импортных электронных компонентов напрямую с производств Америки, Европы и Азии, а так же с крупнейших складов мира;
- Широкая линейка поставок активных и пассивных импортных электронных компонентов (более 30 млн. наименований);
- Поставка сложных, дефицитных, либо снятых с производства позиций;
- Оперативные сроки поставки под заказ (от 5 рабочих дней);
- Экспресс доставка в любую точку России;
- Помощь Конструкторского Отдела и консультации квалифицированных инженеров;
- Техническая поддержка проекта, помощь в подборе аналогов, поставка прототипов;
- Поставка электронных компонентов под контролем ВП;
- Система менеджмента качества сертифицирована по Международному стандарту ISO 9001;
- При необходимости вся продукция военного и аэрокосмического назначения проходит испытания и сертификацию в лаборатории (по согласованию с заказчиком);
- Поставка специализированных компонентов военного и аэрокосмического уровня качества (Xilinx, Altera, Analog Devices, Intersil, Interpoint, Microsemi, Actel, Aeroflex, Peregrine, VPT, Syfer, Eurofarad, Texas Instruments, MS Kennedy, Miteq, Cobham, E2V, MA-COM, Hittite, Mini-Circuits, General Dynamics и др.);

Компания «Океан Электроники» является официальным дистрибьютором и эксклюзивным представителем в России одного из крупнейших производителей разъемов военного и аэрокосмического назначения «**JONHON**», а так же официальным дистрибьютором и эксклюзивным представителем в России производителя высокотехнологичных и надежных решений для передачи СВЧ сигналов «**FORSTAR**».



JONHON

«**JONHON**» (основан в 1970 г.)

Разъемы специального, военного и аэрокосмического назначения:

(Применяются в военной, авиационной, аэрокосмической, морской, железнодорожной, горно- и нефтедобывающей отраслях промышленности)

«**FORSTAR**» (основан в 1998 г.)

ВЧ соединители, коаксиальные кабели, кабельные сборки и микроволновые компоненты:

(Применяются в телекоммуникациях гражданского и специального назначения, в средствах связи, РЛС, а так же военной, авиационной и аэрокосмической отраслях промышленности).



Телефон: 8 (812) 309-75-97 (многоканальный)

Факс: 8 (812) 320-03-32

Электронная почта: ocean@oceanchips.ru

Web: <http://oceanchips.ru/>

Адрес: 198099, г. Санкт-Петербург, ул. Калинина, д. 2, корп. 4, лит. А